

**Lower Thames Crossing  
6.3 Environmental Statement  
Appendices  
Appendix 6.8 – Trial Trenching  
Reports (Volume B)**

APFP Regulation 5(2)(a)

Infrastructure Planning (Applications:  
Prescribed Forms and Procedure)  
Regulations 2009

Volume 6

**DATE: October 2022**

Planning Inspectorate Scheme Ref: TR010032  
Application Document Ref: TR010032/APP/6.3

**VERSION: 1.0**

# Lower Thames Crossing

## 6.3 Environmental Statement Appendices

### Appendix 6.8 – Trial Trenching Reports (Volume B)

#### List of contents

#### Volume A

Archaeological Evaluation Report for Trial Trenching of Land Parcel 1 Masons Corner, Heath Road, Orsett Heath, Essex

OA Archaeological Evaluation Report for Trial Trenching of Land Parcel 2

Archaeological Evaluation Report for Trial Trenching of Land Parcels 3 (North), 30 and 35

Archaeological Evaluation Report for Trial Trenching of Land Parcel 3 Hornsby Lane, Orsett Heath, Essex

Archaeological Evaluation Report for Trial Trenching of Land Parcel 4 Old House, Chadwell St Mary, Essex

Archaeological Evaluation Report for Trial Trenching of Land Parcel 5 Brook Farm, Essex

Archaeological Evaluation Report for Trial Trenching of Land Parcels 6-8, Land West of Linford, East Tilbury, Essex

Archaeological Evaluation Report for Trial Trenching of Land Parcels 6, 8, 9, 10 and 36

Archaeological Evaluation Report for Trial Trenching of Land Parcel 12, Land South of Low Street, Tilbury Marshes, Essex

#### Volume B

OA Archaeological Evaluation Report for Trial Trenching of Land Parcel 21

Archaeological Evaluation Report for Trial Trenching of Land Parcel 22 Whitfield South Scheduled Monument Cropmark Complex, South of Stifford Clays Road, Baker Street, Essex

Archaeological Evaluation Report for Trial Trenching of Land Parcels 3 (North), 30, 31, 35, 103, 104 and 107 Land Bordering the A13 at Orsett, Essex

Archaeological Evaluation Report for Trial Trenching of Land Parcel 37

Archaeological Evaluation Report for Trial Trenching of Land Parcels 55, 56 and 58

## **Volume C**

OA Archaeological Evaluation Report for Trial Trenching of Land Parcel 24, 25, 26, 28 & 29

Archaeological Evaluation Report for Trial Trenching of Land Parcels 40 and 49, North Ockendon, London Borough of Havering

Archaeological Evaluation Report for Trial Trenching of Land Parcels 41, 42, 44 and 60 Land South of Ockendon, in Thurrock, Essex, and the London Borough of Havering

Archaeological Evaluation Report for Trial Trenching of Land Parcels 43, 45A-E and 46 Mar Dyke Valley, between South Ockendon and Orsett

Archaeological Evaluation Report for Trial Trenching of Land Parcels 47 and 48f-h, Mar Dyke Valley between South Ockendon and Orsett, Essex

Archaeological Evaluation Report for Trial Trenching of Land Parcels 48B and 48C Mar Dyke Valley, between South Ockendon and Orsett

## **Volume D**

Archaeological Evaluation Report for Trial Trenching of Land Parcels 54 and 126 Land North of North Ockendon, London Borough of Havering

Archaeological Evaluation Report for Trial Trenching of Land Parcels 71, 72 and 75 Land east of Gravesend and either side of the A226, Chalk, Kent

Archaeological Evaluation Report for Trial Trenching of Land Parcels 76 and 77

## **Volume E**

Archaeological Evaluation Report for Trial Trenching of Land Parcels 80 and 81

**COVER SHEET**

|                      |  |
|----------------------|--|
| <b>Title:</b>        | <b>OA Archaeological Evaluation Report for Trial Trenching of Land Parcel 21</b> |
| <b>Project Name:</b> | <b>Lower Thames Crossing Enabling Works</b>                                      |
| <b>Ref No:</b>       | <b>HE540039-BAL-GEN-GEN-REP-HER-00027</b>  |
| <b>Revision No:</b>  | <b>P01</b>   |
| <b>Review Date:</b>  | <b>11/01/2021</b>  |
| <b>Status:</b>       | <b>S2 – For Information</b>  |
| <b>No. of Pages</b>  | <b>153</b>   |

| <b>Rev</b> | <b>Date of Issue</b> | <b>Revision Status</b> | <b>Originator</b> | <b>Checker</b> | <b>Approver</b> |
|------------|----------------------|------------------------|-------------------|----------------|-----------------|
| P01        | 11/01/2021           | S2 For Information     | Bikash Rana       | Jack Fletcher  | Emily Erswell   |
|            |                      |                        |                   |                |                 |
|            |                      |                        |                   |                |                 |
|            |                      |                        |                   |                |                 |



# Lower Thames Crossing

Archaeological Evaluation Report for Trial Trenching of  
Land Parcel 21  
Whitfield, North of Stifford Clays Road, Baker Street, Essex

Document Number: HE540039-BAL-GEN-GEN-REP-HER-00027

**December 2020**



| Revision | Production Date | Prepared by                     | Checked by                           | Approved for release by | Sections revised |
|----------|-----------------|---------------------------------|--------------------------------------|-------------------------|------------------|
| 1.1      | April 2020      | Mark Dodd<br>Oxford Archaeology | Steve Lawrence<br>Oxford Archaeology | DRAFT                   |                  |
| 1.2      | December 2020   | Tim Allen<br>Oxford Archaeology | Steve Lawrence<br>Oxford Archaeology |                         | Passim           |
|          |                 |                                 |                                      |                         |                  |

This Evaluation Report has been prepared for Highways England in accordance with the terms and conditions of appointment stated in the Lower Thames Crossing (LTC) Technical Partner Contract. LTC cannot accept any responsibility for any use of or reliance on the contents of this document by any third party.

# Contents

---

| Section   | Page      |
|---|-----------|
| <b>Summary</b> .....                                      | <b>7</b>  |
| <b>Acknowledgements</b> .....                             | <b>8</b>  |
| <b>1 Introduction</b> .....                               | <b>9</b>  |
| 1.1 Project details and scope of work .....               | 9         |
| 1.2 Location, topography and geology .....                | 10        |
| 1.3 Previous investigations .....                         | 10        |
| 1.4 Archaeological and historical background.....         | 11        |
| <b>2 Project Aims</b> .....                               | <b>15</b> |
| 2.1 General aims .....                                    | 15        |
| 2.2 Specific objectives .....                             | 16        |
| <b>3 Methodology</b> .....                                | <b>17</b> |
| 3.1 Constraints.....                                      | 17        |
| 3.2 Methodology for the evaluation .....                  | 17        |
| <b>4 Results</b> .....                                    | <b>18</b> |
| 4.1 Introduction and presentation of results .....        | 18        |
| 4.2 General soils and ground conditions.....              | 18        |
| 4.3 General distribution of archaeological deposits ..... | 19        |
| 4.4 Trenches 7, 15, 33, 38, 41 and 56 .....               | 19        |
| 4.5 Trenches 58 and 62 .....                              | 19        |
| 4.6 Trenches 5, 6, 17, 21, 22 and 23 .....                | 19        |
| 4.7 Trenches 27 and 28 .....                              | 20        |
| 4.8 Trenches 71, 72 and 73 .....                          | 20        |
| 4.9 Trenches 74 and 76 .....                              | 22        |
| 4.10 Trench 77.....                                       | 23        |
| 4.11 Trench 78.....                                       | 24        |
| 4.12 Trenches 79 and 80 .....                             | 25        |
| 4.13 Trench 81.....                                       | 26        |
| 4.14 Trench 87.....                                       | 26        |
| 4.15 Trench 96.....                                       | 27        |
| 4.16 Trench 97.....                                       | 27        |
| 4.17 Trench 98.....                                       | 28        |
| 4.18 Trench 99.....                                       | 29        |
| 4.19 Trench 100.....                                      | 29        |
| 4.20 Trenches 101 and 103.....                            | 30        |
| 4.21 Trench 102.....                                      | 31        |
| 4.22 Trenches 88, 104 and 105.....                        | 31        |
| 4.23 Trenches 109 and 116.....                            | 32        |
| 4.24 Trench 111.....                                      | 33        |
| 4.25 Trench 118.....                                      | 33        |
| 4.26 Trenches 119 and 125.....                            | 34        |
| 4.27 Trench 124.....                                      | 34        |
| 4.28 Trench 123.....                                      | 35        |
| 4.29 Finds summary .....                                  | 36        |

|                   |  |            |
|-------------------|--|------------|
| 4.30              | Environmental summary .....              | 36         |
| <b>5</b>          | <b>Discussion .....</b>                  | <b>37</b>  |
| 5.1               | Reliability of field investigation ..... | 37         |
| 5.2               | Interpretation.....                      | 38         |
| 5.3               | Evaluation objectives and results.....   | 40         |
| <b>Appendix A</b> | <b>Trench Tables .....</b>               | <b>42</b>  |
| <b>Appendix B</b> | <b>Finds Reports .....</b>               | <b>82</b>  |
| <b>Appendix C</b> | <b>Environmental Reports .....</b>       | <b>95</b>  |
| <b>Appendix D</b> | <b>References .....</b>                  | <b>108</b> |
| <b>Appendix E</b> | <b>Abbreviations and Glossary .....</b>  | <b>111</b> |
| <b>Appendix F</b> | <b>Site Summary.....</b>                 | <b>112</b> |

## Tables

|           |   |
|-----------|---|
| Table 1:  | Summary and quantification of the pottery by context                  |
| Table 2:  | Catalogue of ceramic building material                                |
| Table 3:  | Catalogue of fired clay   |
| Table 4:  | Breakdown of flint assemblage by type                                 |
| Table 5:  | Metal finds by context  |
| Table 6:  | Assessment of CPR flots   |
| Table 7:  | Burnt bone – Osteological summary                                     |
| Table 8:  | Burnt bone – Summary of Fragmentation                                 |
| Table 9:  | Burnt Human Bone – Summary of Identified Elements                     |
| Table 10: | Summary of animal bones by context                                    |
| Table 11: | Breakdown of identified bones by species and periods represented      |
| Table 12: | Non-species data recorded from the specimens (NSP) in the assemblage. |



## Figures

Figure 1: Map showing the location of Land Parcel 21

Figure 2: Plan of trenches, cropmark features and archaeological features

Figure 3: Detailed overview of north half of site

Figure 4: Detailed overview of south half of site

Figure 5: Plan of Trenches 5-7

Figure 6: Plan of Trenches 15-17

Figure 7: Plan of Trenches 33 and 38

Figure 8: Plan of Trenches 41 and 56

Figure 9: Sections (Trenches 6, 7, 15, 17, 20, 21-23, 27, 28, 38, 41 and 56)

Figure 10: Plan of Trenches 56-58 and 61-62

Figure 11: Plan of Trenches 21-23

Figure 12: Plan of Trenches 27-28

Figure 13: Plan of Trenches 71-73

Figure 14: Sections (Trenches 58, 71, 72, 73 and 74)

Figure 15: Plan of Trenches 74-76

Figure 16: Plan of Trenches 77-80 and 72

Figure 17: Sections (Trenches 76, 77 and 78)

Figure 18: Plan of Trenches 81 and 96-98

Figure 19: Sections (Trenches 79-81, 87, 96, 98 and 99)

Figure 20: Plan of Trenches 87-89

Figure 21: Plan of Trenches 91 and 99-104

Figure 22: Sections (Trench 100)

Figure 23: Sections (Trenches 101-103)

Figure 24: Plan of Trenches 109-111 and 115-117

Figure 25: Plan of Trenches 105-106, 118-119 and 124-125

Figure 26: Sections (Trenches 105, 109, 116, 118-119 and 125)

Figure 27: Sections (Trench 124)

Figure 28: Graph showing condition of identified specimens, expressed as a percentage of NISP (following Behrensmeyer 1978).

## Plates

Plate 1: Ditch 602 looking north

Plate 2: Ditch 2102 looking east

Plate 3: Ditch 2104 looking east

Plate 4: Ditch 2302 looking west

Plate 5: Ditch 7105 looking east

Plate 6: Ditch 7404 looking east

Plate 7: Section 7600 in Trench 76, looking south

Plate 8: Trench 77 stripped and partly excavated, looking north

Plate 9: Ditches 7703 and 7705, looking south

Plate 10: Section 7701 looking south

Plate 11: Ditch 7717 looking east

Plate 12: Ditch 7804 looking WSW

Plate 13: Pits 7807 and 7809, looking south-east

Plate 14: Cremation 9610 with vessel 9611 and fill 9612, looking east

Plate 15: Section through deposit 9703, looking north-east

Plate 16: Ditches 9902 and 9913, looking west

Plate 17: Section through ditches in Trench 100, looking south-west

Plate 18: Ditches 10102 and 10104 with pit 10107, looking north-east

Plate 19: Ditches 10303 and 10306, looking south-east

Plate 20: Ditch 10202 looking west

Plate 21: Ditch 10504 looking south

Plate 22: Ditch 11902 looking south

Plate 23: Ditch 12503 looking south

## Summary

---

Oxford Cotswold Archaeology was commissioned by Balfour Beatty to undertake a trial trench evaluation of Land Parcel 21 of the Lower Thames Crossing Pre-Enabling Works. Land Parcel 21, also known as Whitfield North, is located c 600m WNW of the village of Baker Street within the county of Essex and Thurrock unitary authority (NGR 562736 181588). The evaluation comprised 128 trenches and was completed between the 4th February and the 18th March 2020.

Due to unforeseen constraints, including localised flooding, only 116 of the 128 trenches could be excavated. Of these, a total of 46 trenches revealed features of archaeological significance. These features were predominantly situated on the higher elevations along the southern limit of the site, coinciding with the geology of Boyn Hill sand and gravels, although some isolated activity was also present further north on the clay and silt head deposits.

The earliest activity was represented by a small assemblage of struck flint, which included pieces of Mesolithic or early Neolithic date and other tools of later Neolithic or early Bronze Age date. There were no features dated to these periods found in the evaluation. The only possible evidence for later Bronze Age activity was a single sherd of late Bronze Age or early Iron Age pottery, and none of the struck flints appeared to be of this date.

At the south end of the site enclosure ditches of middle Iron Age date were found, and although not directly dated, several penannular gullies are likely to be of similar date. In the late Iron Age to early Roman period settlement activity intensified, and continued throughout the Roman period, though tailing off in the late Roman period.

North of this lines of parallel slots, vertical-sided and flat-bottomed with deliberate backfills, some containing Roman pottery, were found running east-west in two parts of the field, and these may represent associated agricultural activity of Roman date.

No activity of Saxon or medieval date was found on the site. Post-medieval field boundaries were encountered in the north, central and south-eastern parts of the site, together with a post-medieval pit at the south-east end of the site.

## Acknowledgements

---

Oxford Cotswold Archaeology would like to thank the client, Balfour Beatty, for commissioning this project and managing the site safety and attendances. Thanks are also extended to the Historic Environment Consultants (Richard Havis and Katie Lee-Smith) of Place Services for Essex County Council advising the Borough of Thurrock, for monitoring and providing advice throughout the project.

The project was managed for Oxford Cotswold Archaeology by Steve Lawrence. The fieldwork was directed by Mark Dodd and Ben Slader, who were supported by Jana Smirnova, Dan Firth, Eilidh Barr, Fanny Dubuc, Jessica Domiczew, James Fish, Ioannis Thanos, Jack Easen, Vicky Green, Rory Coduri, Zsuzsanna Veres, Ed Worsley, Daniel Sendek, Nick Cox, Lyndsey Kemp, George Gurney, Tara Schug, Meagan Mangum, Alice Crush, James Sinclair, Adrian Arenas, Enrico Ravanetti and Barbara Grahame. Site survey was undertaken by Caroline Souday and Rachel Alexander and digitising was carried out by Gary Jones, Benjamin Brown and Simon Batsman. Thanks are also extended to the teams of OA staff that cleaned and packaged the finds under the management of Leigh Allen and Geraldine Crann, processed the environmental remains under the management of Rebecca Nicholson, and prepared the archive under the management of Nicola Scott.

# 1 Introduction

---

## 1.1 Project details and scope of work

- 1.1.1 The Lower Thames Crossing Project is located between the A2 in Kent and the M25 in the London Borough of Havering. It will run underneath the River Thames through a tunnel and emerge on the northern side of the river at East Tilbury. From the North Portal the road will run to the M25 at Junction 29 via the A13 and pass between North and South Ockendon. The development of the project is managed by LTC, a partnership between Highways England and a consultancy joint venture set up to oversee the scheme.
- 1.1.2 A programme of archaeological trial trenching began in the Essex part of the scheme in November 2019. A scheme-wide specification for trial trenching was written by LTC (Highways England 2018), and in July 2019 LTC commissioned Balfour Beatty to deliver the pre-Enabling Works. Balfour Beatty appointed Oxford Archaeology (hereafter OA) to prepare a project-wide written scheme of investigation (WSI) for the scheme, which (at the request of the key archaeological stakeholders) is divided into two parts, one for the Kent section, the other for Essex and Havering (Oxford Archaeology 2019a, 2019b).
- 1.1.3 Following completion of the project-wide WSIs, OA was also instructed to prepare a series of site-specific or group-site specific WSIs for approval by the key archaeological stakeholders in advance of trial trenching to inform the Development Consent Order (DCO). A detailed WSI was created for Land Parcel 21 prior to the trial trenching (Oxford Archaeology 2019c). The WSI details the archaeological background and potential within Land Parcel 21 (Oxford Archaeology 2019c). It also indicated the archaeological aims and objectives appropriate to the investigation of this land parcel by trenching and set out the methodology. This WSI was approved by Richard Havis, Principal Historic Environment Consultant for Place Services, Essex County Council, prior to the start of the fieldwork. Oxford Cotswold Archaeology was commissioned as Balfour Beatty's archaeological contractor to undertake the evaluation in accordance with the approved WSI and local and national planning policies.
- 1.1.4 The fieldwork was completed between the 4th February and the 18th March 2020. All work also followed the MoRPHE Project Manager's guide (Historic England 2015), and the Code of Conduct of the Chartered Institute for Archaeologists (CIfA). The archaeological works adhered to the standards and guidance for archaeological evaluation, excavation and archiving (CIfA 2014a; CIFA 2014b).
- 1.1.5 The work was monitored by Richard Havis and Katie Lee-Smith, Place Services, ECC advising the Borough of Thurrock.

## 1.2 Location, topography and geology

- 1.2.1 Land Parcel 21 is located c 600m WNW of the hamlet of Baker Street (Fig. 1) within the county of Essex and Thurrock unitary authority (NGR 562736 181588). The parcel itself is roughly C-shaped and covers an area of 23.66ha. This land parcel is bounded to the west by agricultural fields and Springfield Cattery, to the north by Green Lane, to the east by further agricultural fields and Whitfields Farm and to the south by Stifford Clays Road.
- 1.2.2 The bedrock geology of this land parcel is London Clay Formation (clay, silt and sand). The superficial geology of the land parcel is mixed with the southern part of the land parcel underlain by the Boyn Hill Gravel Member (sand and gravel) and the majority of the land parcel underlain by Head (clay, silt, sand and gravel). This land parcel is currently in use as part of two large arable fields located north of Stifford Clays Road
- 1.2.3 This land parcel is situated on a slope on the southern side of the Mar Dyke valley. The Mar Dyke itself is located 1km north-west of the land parcel. The southern edge of the site is situated on the edge of a plateau where the terrace is at a height of c 21-24m aOD. The ground slopes downwards to the north and the lowest point of the land parcel is along the northern edge at 10-15m aOD. Colluvial deposits of head have accumulated along the slopes of the terrace and within the Mar Dyke river valley.

## 1.3 Previous investigations

- 1.3.1 No known below-ground archaeological investigation has been undertaken within this land parcel.

## 1.4 Archaeological and historical background

- 1.4.1 The chronological summary of known archaeology given below is taken from the detailed WSI for Land Parcel 21 (Oxford Archaeology 2019c). The site is situated within the valley and on the slopes of the terrace to the south of the Mar Dyke valley where Holocene prehistoric features, findspots and cropmarks have been identified. The cropmarks that have been recorded within and around the land parcel are those mapped by the Aerial Investigation and Mapping report (Place Services 2019). These cropmarks are shown on Figure 2.
- 1.4.2 **Palaeolithic.** No Palaeolithic finds have been recorded within 1km of the site. Palaeolithic finds have been recorded c 2km south-east of the site on the outskirts of Chadwell St Mary.
- 1.4.3 **Mesolithic.** Residual Neolithic and Mesolithic flints were recorded at William Edwards School in 1997, located 0.6km south-west of the site. Apart from this instance, no other Mesolithic finds have been recorded within 1km of the site. Mesolithic finds spots have been recorded 2-2.5km south-east of the site.
- 1.4.4 **Neolithic.** A scheduled early Neolithic causewayed enclosure (Aerial Mapping Report site 17A) is located 2.5km east-south-east of the land parcel.
- 1.4.5 A narrow rectangular enclosure was recorded as a cropmark 1.5km south-east of the site. This feature was aligned east-west with rounded ends, and from its morphology this is suspected to be a mortuary enclosure of Neolithic date.
- 1.4.6 **Early Bronze Age.** No early Bronze Age features have been excavated within the site or its vicinity, but a circular ring ditch, 32m in diameter, is located 250m east of the site and this is probably the remains of an early Bronze Age barrow that was situated on the slope of the edge of the terrace (Aerial Investigation and Mapping Report 82).
- 1.4.7 **Later Bronze Age and Iron Age.** There are two adjacent circular ring ditches or penannular gullies c 14-16m diameter within the southern part of the site. These lie within a group of cropmark enclosures that continue south of Green Lane, and form part of the Orsett (Grey Goose Farm) Cropmark Complex, the majority of which is a scheduled monument. The main concentration of cropmarks was located along the edge of the gravel terrace, but continued further south (Aerial Investigation and Mapping Report 13). The complex south of Green Lane (scheme Land Parcels 22 and 23) includes further smaller circular or penannular ring ditches (Aerial Investigation and Mapping Report 13, 14 and 15). The penannular ring ditches within the site (and probably those further south) are more likely to represent domestic enclosures than barrows, as both features have a possible entrance on the south-east or eastern side. This, along with their small size, suggests they may represent roundhouse sites dating to the later Bronze Age or Iron Age. Another likely example of such an enclosure, located 0.5km east of the site and again on the north edge of the terrace, is visible as a cropmark at Baker Street (Aerial Survey site 49).

- 1.4.8 During work on the A13 in 1979 several features dated to the late Bronze Age to early Iron Age were recorded within the southern part of the scheduled monument and 0.4km south of land parcel 21. These included one large and three small pits, postholes and a short gully (Wilkinson 1988, 13-16). Several cropmark sub-circular and rectilinear enclosures, linear features and a possible east-west trackway were recorded within the northern part of the scheduled monument just south of Green Lane by the aerial survey (Aerial Investigation and Mapping Report 13), and some continue into the south edge of land parcel 21. It is therefore possible that some of those on the site could date from the late Bronze Age or early Iron Age.
- 1.4.9 A handful of late Bronze Age/early Iron Age features were recorded at William Edwards School in 1997, located 0.6km south-west of the site. This included a large pit containing late Bronze Age pottery, several pits containing flints, several linear features and an undated well truncated by a pit containing Bronze Age flints (Lavender 1998, 19-24).
- 1.4.10 Another prehistoric scheduled monument comprising a middle to late Bronze Age Springfield style enclosure (or ring-fort) and an overlying settlement believed to date to the Iron Age is located to the east of the Orsett cropmark complex, c 500m to the east of the site boundary. Further possible prehistoric features, including a probable Bronze Age barrow and circular features, have been identified 200m to the south-west of this (Aerial Investigation and Mapping Report 49).
- 1.4.11 The Neolithic causewayed enclosure located 2.5km east-south-east of the site was overlain by an unenclosed early Iron Age site and a middle Iron Age sub-rectangular enclosure (Hedges and Buckley 1978, 219-308).
- 1.4.12 A large quantity of high status Iron Age material was recovered by metal detectorists from a field 2km south-east of the land parcel and within an extensive rectilinear enclosure.
- 1.4.13 **The Roman period.** No Roman remains have been recorded within the Land Parcel 21 site. A late Iron Age to late Roman farmstead at Stifford Clays-Primrose Island, c 0.6km south-west of the site, was excavated in the 1960s and 1970s, and this was in use from the late Iron Age to the late Roman period with enclosures, ditches, pits, cremations and a corn drying oven. Another possible Roman enclosure site, recorded by the Aerial Mapping survey as a double ditched enclosure on the edge of the terrace, lies 0.2km south-east of the site. These sites are strung along the north edge of the gravel terrace, and it is possible that some of the enclosures at the south edge of Land Parcel 21 might be of similar date, possibly alongside a track following the terrace edge, and continuing east to Roman settlement around Orsett Cock further east.
- 1.4.14 Individual findspots of Roman glass were identified 0.6km west of the site, although these records may be duplicate entries as one is from the Essex HER and one from Pastscape.
- 1.4.15 An extensive cropmark complex that includes one very large rectilinear enclosure and several smaller ones linked by trackways or field boundaries was identified by the aerial survey 2km south-east of the site. This has now



been evaluated by trial trenching for the scheme, and has been confirmed as of Roman date (OCA 2020a, Land Parcel 3).

- 1.4.16 **The medieval period.** Excavations on the line of the A13 passing to the south of the land parcel, recorded Saxon artefacts from several features, demonstrating that there was Saxon activity in the vicinity.
- 1.4.17 Middle Saxon activity has been identified to the east and south-east of the land parcel. The Orsett causewayed enclosure, located 2.5km ESE of the site, was reused as a Saxon funerary monument in the 7th-8th century. A Saxon settlement was also located 2.7km east of the site at Orsett Cock.
- 1.4.18 In the late Saxon and later medieval period the land parcel was located within the parish of Orsett. The nucleated medieval settlement of Orsett was located 1km east of the site. It is likely that in the later medieval period the land parcel was used as agricultural land associated with this settlement.
- 1.4.19 In 1994 a watching brief was undertaken at Grey Goose Farm located c 500m south of the site. A domestic rubbish pit was found including oyster shell, burnt organic material and medieval pottery dating to the 12-13th century. This suggests that there may have been medieval activity in the vicinity, possibly a farmstead situated south of the Stifford Road.
- 1.4.20 A number of possible medieval droveways have been observed as cropmarks within the wider area and several of these have been identified within the scheduled monument directly south of the site. These droveways may have been used to take livestock to and from the marshland or lowland to the upland ridge. Several trackways were identified south of the Stifford Clays Road and c 0.3km south of the site during the 1979 excavation along the A13. One ditch appeared to be a continuation of a NNW-SSE aligned trackway to the north. Feature 57 was another NNW-SSE aligned ditch which very likely continued as a trackway to the north. This ditch cut across a possible earlier settlement as indicated by the cropmarks and it contained residual sherds of either late Iron Age or medieval pottery. Another trackway oriented NE-SW was recorded just east of feature 57, the ditches containing abraded (and probably residual) Roman pottery (Wilkinson 1988, 16-17).
- 1.4.21 The Orsett Tithe map (c 1840) and the aerial survey suggested that two long- standing field boundaries may be preserved within the western part of the site. The westerly feature is preserved as an extant hedgerow whereas the easterly feature was recorded as a cropmark. The tithe map shows these two NNW-SSE parallel linear features extending as far as the Mar Dyke to the north and down to the Stifford-Stanford Road to the south. It is possible that these boundaries define a former droveway, although whether of medieval or post-medieval origin is unknown. The only cropmarks that can be tentatively dated are the NNW-SSE and ESE-WSW linear field boundaries which may be medieval or post-medieval in date.
- 1.4.22 **Post-medieval period.** Documentary evidence indicates that during the later post-medieval period the site was situated just to the north of a roughly east-west road from Stifford to Orsett. The hamlet of Baker Street located immediately south-east of the site may have had its origins in the later medieval or early post-medieval period. This hamlet is located at a

crossroads between the east-west road from Stifford to Orsett and a north-south road leading to Chadwell. Several listed buildings are located within the hamlet of Baker Street and the two oldest are the Mill House, a Grade II listed 15th-16th century house located 100m south-east of the site and Whitfields, a Grade II listed late 16th century house, located 100m east of the site. The barn associated with Whitfields dates from the 17th century. A 17th century windmill is located 200m south-east of the site and an early 18th century house is located 150m east of the site.

- 1.4.23 The OS map of 1897 indicates that Whitfields Farm was located immediately east of the site. It also shows that there was a building just north of Stifford Clays Road just south-east of the site (Wayside Cottage). A possible pond is shown on the Orsett Tithe Map of c 1840 (not illustrated) just west of this building which had been infilled by the 20th century and part of this pond was located within the area of the site. The tithe map also shows that at least three buildings were located in the area of the present Springfield Cattery. This parcel is described as a house, yard, garden, stable and shed. It was later shown as 'Springfield' on the later 19th century OS maps.
- 1.4.24 During the later post-medieval period the site was in use as agricultural land and the eastern half of the site was associated with Whitfields Farm. This is indicated by the tithe apportionment associated with the Orsett Tithe map (c 1840). The western part of the site may have been associated with Springfield although this house is not listed as a farm in the tithe apportionment or on the later OS maps. Several of the field boundaries shown on the Orsett Tithe map (c 1840) are preserved as hedgerows or as cropmarks within the site. These field boundaries are likely to date from the post-medieval period.
- 1.4.25 **Undated features and cropmarks.** Scheme Land Parcel 21 contains three discrete pit-like cropmark features. The undated pits that have been identified within the site may be prehistoric, medieval or post-medieval, although some may be geological in origin. A number of 'pit' features were excavated prior to the widening of the A13 some 0.5km south of the site in the late 1970s. These features appeared as discrete sub-circular pits on the aerial photographs, but excavation showed that some of these features were natural periglacial features, and several were interconnected (Wilkinson 1988, 15).
- 1.4.26 The site also contains a number of linear features and rectilinear and sub-circular enclosures. Based on the previous investigations within the surrounding area it is likely that the cropmarks represent multi-period activity dating from the prehistoric to post-medieval period, and have been mentioned above under several periods.

## 2 Project Aims

---

### 2.1 General aims

- 2.1.1 The general project aims of the project were as follows:
- 2.1.2 To establish the presence or absence of archaeological remains along the line of the scheme, and the extent of any areas where remains appear likely to be absent;
- 2.1.3 In areas where archaeological remains are known or suspected, to clarify the reliability of the cropmark or geophysical survey evidence;
- 2.1.4 In areas where no archaeological remains are indicated by aerial or geophysical survey, to clarify whether this apparent absence of remains is genuine;
- 2.1.5 To determine the degree of complexity of any surviving horizontal or vertical stratigraphy, and in particular, to investigate areas where topography indicates the likelihood of deep deposit sequences for evidence of buried archaeological horizons and palaeo-environmental sequences;
- 2.1.6 Where remains are present, to determine the period(s) represented, the extent, state of preservation and character of the archaeological remains;
- 2.1.7 To establish the range and state of preservation of archaeological artefacts, and through their recovery and examination, to establish the potential for information about the economy, status and contacts of past inhabitants of the scheme footprint;
- 2.1.8 To determine whether palaeo-environmental remains are preserved, and, where these are found, to determine their types (eg charred plant remains, waterlogged remains, molluscan remains), state of preservation and potential for environmental information. This will be achieved through the recovery of samples from sedimentary sequences and archaeological features suitable for assessment of a range of palaeoenvironmental remains (e.g. charred and waterlogged plant remains, charcoal, insects, pollen, diatoms, ostracods/foraminifera and molluscs) and scientific dating (e.g. radiocarbon and OSL dating);
- 2.1.9 To investigate and record the extent, character and chronology of the sedimentary sequences, in particular those immediately adjacent to and in floodplains, contained within palaeochannels or in dry valleys, and to use the data to refine existing geoarchaeological (predictive) deposit models.
- 2.1.10 To place any identified archaeological remains into their local and, where appropriate, regional or national context, and to assess the implications of any such discoveries for our current understanding of settlement and landscape change in the area, including an assessment of the associations of any remains with reference to the historic landscape;
- 2.1.11 To provide sufficient information to enable the LTC archaeological advisor, in consultation with the Key Archaeological Stakeholders, to determine the significance of the archaeological assets identified within the land parcel;

- 2.1.12 To provide a report on the discoveries to inform the Environmental Statement (ES) supporting the Development Consent Order (DCO) and support the preparation of a further archaeological mitigation strategy for the Enabling Works and Construction phases of the scheme;
- 2.1.13 Following the DCO, to deposit the report in the public domain, and to generate an accessible and useable archive which will allow future research of the evidence to be undertaken.

## 2.2 Specific objectives

- 2.2.1 The specific project objectives were as follows:
- 2.2.2 To conduct the programme of archaeological investigation within the general research parameters and objectives defined by the revised East of England Research Framework (Medlycott 2011).
- 2.2.3 To clarify whether the cropmarks provide an accurate representation of the range, quantity and types of archaeological features present within the southern part of the parcel;
- 2.2.4 To determine whether the absence of archaeological cropmarks over the central and northern parts of the site is genuine, or is due to the masking effect of colluvial deposits on the slopes of the gravel terrace edge leading down into the Mar Dyke valley;
- 2.2.5 If archaeological horizons do exist preserved beneath colluvial deposits, to date them, establish their extent and state of preservation, and whether surface activities not usually preserved on the terraces are present;
- 2.2.6 To establish the duration and complexity of colluviation, and its potential for elucidating the environmental history of activity on the gravel terraces to the south;
- 2.2.7 To clarify whether the circular or penannular ring-ditches are the remains of Bronze Age burial monuments or domestic structures of the later Bronze Age or Iron Age, and if the former, to establish their date and duration of use within and beyond the period;
- 2.2.8 To establish when settlement began within the site, whether this includes domestic structures represented by the ring ditches, and if not, how settlement activity relates to the burial monuments adjacent;
- 2.2.9 To determine the date of the rectilinear enclosures at the south end of the site, whether later Bronze Age, Iron Age, Roman or medieval, and to investigate their function and longevity;
- 2.2.10 For the early medieval period, to determine whether Anglo-Saxon sunken-featured buildings and other buildings are present within the site, and to determine the extent, density, character and status of any settlement;
- 2.2.11 To establish the date of the possible medieval or post-medieval field boundaries that have been identified within the land parcel;
- 2.2.12 To establish the presence or absence of possible medieval droeways aligned through the land parcel;
- 2.2.13 To establish the presence or absence of medieval and post-medieval farmsteads which may have been located within the land parcel.

## 3 Methodology

---

### 3.1 Constraints

- 3.1.1 Several constraints limited the area of the land parcel available for trial trenching. These comprised two sets of high level pylons, aligned NNW-SSE, buried irrigation pipes, a foul water pipe in the south-eastern part of the site and ecological constraints.
- 3.1.2 These limitations were taken into account when designing the detailed trench layout. Further alterations to the layout were implemented during the fieldwork phase to avoid areas of standing water encountered during the wet conditions.
- 3.1.3 In accordance with the safe system of work established by Balfour Beatty, excavation was ceased at a maximum depth of 1m below ground level. Inevitably, several of the larger features could not be excavated to full depth within the constraints of this programme of works.

### 3.2 Methodology for the evaluation

- 3.2.1 The total land parcel area was 23.66ha, and the area available for investigation excluding areas of services, hedgerows and other constraints was 23.24ha. The archaeological trial trenching comprised a total of 128 trenches, most measuring 30m x 2m, represent a 3.86% sample of the area available for trenching. The location of the trenches is shown on Figure 2.
- 3.2.2 The trench design was developed to target cropmark features identified by the aerial investigation and mapping report (Place Services 2019), and otherwise to provide even coverage of the blank areas. Due to the constraints, and to the features to be targeted, the trenches at the south were not laid out on a standard grid, but were spaced to avoid any large gaps, and to cover all underlying geologies. Particular attention was paid to target the ring ditches and their immediate surroundings, as well as to the rectilinear enclosures, the linear features and the discrete cropmark features. A proportion of the trenches have been aligned at right angles to the orientation of the valley slope. (Fig. 2).
- 3.2.3 Trenches 2, 3, 4, 8, 10, 11, 12, 13, 19, 45, 48 and 75 were not excavated due to the positioning of the site compound and localised flooding in these locations.
- 3.2.4 All trenches were located using a Global Positioning System (GPS) prior to machine excavation. All trenches were excavated using a tracked excavator fitted with a toothless bucket under constant archaeological supervision.
- 3.2.5 Revealed features were hand cleaned where appropriate and sampled by hand excavation. They were recorded as outlined with the approved WSI. All finds were bagged by context throughout the evaluation and were recovered for further investigation.

## 4 Results

---

### 4.1 Introduction and presentation of results

- 4.1.1 The results of the evaluation are presented below, and include a stratigraphic description of the trenches that contained archaeological remains. The full details of all trenches with dimensions and depths of all deposits, and a summary of the finds, can be found in Appendix A. Finds data are tabulated and reported upon in Appendix B, and environmental materials in Appendix C.
- 4.1.2 Context numbers reflect the trench numbers unless otherwise stated. The first numerals of a context number reflect the trench number whilst allowing for a maximum range of 100 individual records for any one trench. For example, pit 102 is a cut within Trench 1, while ditch 304 is a cut within Trench 3.
- 4.1.3 An overview of the results for the site is shown on Figure 2, and slightly more detailed views of the north and south halves of the site in Figures 3 and 4. Further detailed plans and sections of the trenches that contained archaeological features are shown on Figures 5-27.

### 4.2 General soils and ground conditions

- 4.2.1 The ploughsoil measured between 0.2 and 0.4m thick, the variation in depth resulting from mixed agricultural activities across the site. In parts of the site this overlay a thin subsoil layer. A thicker deposit of subsoil was recorded in the southeast portion of the site; in the lower lying trenches closest to Baker Street the subsoil was preserved up to 0.36m thick. The underlying natural geology changed from the Boyn Hill sand and gravels in the southern, elevated portion of the site to mixed head deposits of clay, silt, sand and gravel as the site descended to the north towards the Mardyke valley. No deep colluvial sequences were found on the site.
- 4.2.2 The fieldwork was accompanied by a period of unusually wet weather that led to frequent flooding of the trenches. Although the gravel geology in the southern area of the site was relatively well-draining, groundwater was frequently encountered at a depth of approximately 0.8m. The majority of deep features were therefore quickly inundated with water and heavy rainfall was slow to drain away. The persistent nature of the poor conditions meant that the programme of works was adapted accordingly and work was postponed in any flooded areas of the site until they could be pumped out, or drier conditions prevailed. Consequently, the impact of the poor conditions was kept to a minimum, allowing the investigations to continue. Where present, archaeological features were easily identifiable against the natural geology, and the initial investigation of features of natural origin provided a solid benchmark for distinguishing these from archaeological features without the later need for excavation.

## 4.3 General distribution of archaeological deposits

- 4.3.1 Archaeological features were revealed in 46 of the trenches: 5-7, 15, 17, 21-23, 27-28, 33, 38, 41, 56, 58, 62, 71-74, 76-81, 87- 88, 95-105, 109, 111, 116, 118-119, 124 and 125.
- 4.3.2 The predominant concentration of archaeological features was along the southern edge of the site, coinciding with the sand and gravel geology. Features comprised a combination of enclosures ditches, post holes, pits and penannular ditches, dated to either the Iron Age or Roman periods.
- 4.3.3 The remains of an urned cremation of Roman date from Trench 96.
- 4.3.4 Few archaeological features were revealed to the north once the geology changed from gravels to head deposits. The only exceptions include post-medieval field boundary ditches in Trenches 7, 15, 33, 38, 41 and 56 and possible Roman horticultural features in Trenches 5, 6, 17, 21, 22 and 23.
- 4.3.5 All other trenches were devoid of archaeology.

## 4.4 Trenches 7, 15, 33, 38, 41 and 56

- 4.4.1 Trenches 7, 33 and 38 exposed parts of a north-south aligned ditch (Fig. 5, 702; Fig. 7, 3302 and 3802), and Trenches 15, 41 and 56 parts of another parallel ditch some 45m further west (Fig. 6, 1502 and Fig. 8, 4103 and 5603). All of the cuts except for 3302 were excavated, and both ditches had similar steep-sided profiles (Fig. 9). The eastern ditch was around 1m wide and 0.4-0.5m deep, deeper downslope in Trench 7 on the north. There were two fills in 3802 and four in 702, all the result of natural silting, but none contained any finds. The western ditch was 1.5m deep in Trench 56, but narrowed to just under 1.2m as it ran north, and was around 0.5m deep, with only a single fill. Post-medieval tile was recovered from the fill in cut 5603. These ditches coincide with historic field boundaries recorded on the 1873 Ordnance Survey map and represent the remains of post-medieval field systems.

## 4.5 Trenches 58 and 62

Trench 58 exposed a linear feature 5802 aligned north-south and roughly parallel to ditch 5603 some 47m to the east (Fig. 10). Unlike ditch 5603, however, 5802 was 1.4m wide but had a broad, shallow profile and was only 0.16m deep (Fig. 14). Trench 62 exposed a similar feature 6202 aligned WSW-ENE that was 1.7m wide and only 0.15m wide. Both features contained a single naturally silted deposit without finds. Although undated, it is likely that they were both the remains of plough furrows.

## 4.6 Trenches 5, 6, 17, 21, 22 and 23

- 4.6.1 East of the north-south boundary ditch in Trench 7, another north-south ditch was exposed in Trenches 5 and 6 (Fig. 5). Ditch 602 was of very different character to the ditch in Trench 7, with almost vertical sides a flattish base and a mixed silty clay fill suggesting deliberate backfill (Fig. 9; Plate 1). Ditch terminus 502 to the north was in line with 602, and shared the almost vertical sides and flattish base, though the fill was less obviously deliberate backfill. No finds came from either cut. To the south, this ditch

was not visible in Trench 20 some 50m distant, so presumably ended or changed direction before it.

- 4.6.2 Beyond Trench 20, and some 70m to the south of Trench 6 (see Fig. 3), Trench 21 revealed three, parallel ditches on an east-west alignment and approximately 8.2m apart (Fig. 11). These were numbered 2108, 2102 and 2104 from north to south. All three were of similar dimensions, 0.65-0.7m wide and just over 0.5m deep, with near-vertical sides and flat bases (Fig. 9). Each ditch appears to have been rapidly backfilled shortly after excavation, as evidenced by the mixed grey and orange-brown silty clay deposits recorded in them (Plates 2 and 3). A small amount of Roman pottery was recovered from each of the three features. Environmental samples S.14 and S.15 were taken from fills 2106 and 2107 within ditch 2104, but the charcoal in both was comminuted, and only a single charred grain, unidentifiable to species, was found.
- 4.6.3 Probable continuations of ditch 2104 were seen on the same alignment in Trenches 22 (2202) and 23 (2304), and in Trench 17 (Fig. 6, 1702), although the excavated cuts were more V-profiled and shallower (Fig. 9 sections 1700 and 2200). A ditch parallel to 1702, and around 8.5m to the north, is in line with 2102, and although not excavated, may well be a continuation. No continuation of ditch 2108 was seen in Trench 18 north of Trench 17, but another parallel ditch (2302) was found in Trench 23 9.5m south of ditch 2304. This ditch had one vertical and one sloping side, and a wide but cupped base (Fig. 9), so was broadly similar in profile to the ditches in Trench 21. There were two fills, both suggesting deliberate backfill, neither of which contained finds (Plate 4).
- 4.6.4 Although separated by a considerable distance and without dating evidence, the ditch appearing as 602 and 502 was perpendicular and of similar profile and deliberate fill to those dated as Roman in Trench 21, so may belong to the same system and have had a similar function to those further south.

## 4.7 Trenches 27 and 28

- 4.7.1 On the west edge of the site, and north-west of Trench 41, Trenches 27 and 28 each exposed an east-west ditch, and Trench 27 also revealed a pit (Fig. 12). The ditches lay 29m apart (centre to centre), and the more northerly ditch (2703) was the larger, being nearly 1m wide and 0.42m deep. Ditch 2703 had a slightly irregular, concave profile, and contained a single homogenous fill of naturally accumulated silty clay, which was without finds. Ditch 2803 was only 0.54m wide but was 0.45m deep, with steep sides and a narrow concave base. A small fragment of Roman pottery was found in its sole fill 2804, a mottled orange-brown and grey silty clay.

## 4.8 Trenches 71, 72 and 73

- 4.8.1 In the south-west corner of the site Trenches 71, 72 and 73 were laid out from west to east to cross an east-west linear cropmark and other cropmarks parallel and at right angles on the south side, appearing to form a field or enclosure system (Fig. 4). Trench 71 found ditches corresponding



to two WSW-ENE cropmarks, together with two other linear features on the north side that were not evident as cropmarks (Fig. 13).

- 4.8.2 Ditches 7103 and 7110 were both aligned north-south, and were just over 1m apart. They were both broad (1.58m and 1.08m wide respectively) with shallow concave profiles, and were respectively 0.26m and 0.2m deep (Fig. 14; Plate 5). Both features contained similar, naturally silted deposits and are likely to have had similar functions. No dating evidence was recovered from either, but 7103 was planned as cutting across ditch 7112 at the south.
- 4.8.3 Although recorded in plan only, soilmark 7112, which was 3.1m wide, crossed the trench on a WSW-ENE alignment, and corresponded to a linear cropmark, so was probably a large boundary ditch. Cropmark evidence indicates that it continued to the east, and coincided with ditch 7202 at the northern end of Trench 72.
- 4.8.4 Ditch 7105 ran parallel to 7112 some 7.5m further south. It was 1.54m wide and 0.64m deep with a steep concave profile (Fig. 14). The first two fills (7106 and 7107) were spills of sand and gravel down the south side, perhaps indicating that upcast from digging the ditch had formed a bank on this side (Plate 4). No finds were recovered from this feature, although the middle fill did include charcoal. Ditch 7105 probably correlated with one of the linear cropmarks, although offset by about 2m from the plotted cropmark line. A linear clayey soilmark (7113) was plotted south of 7105, but upon investigation it proved to be of geological origin. The cropmarks of both ditch 7105 and 7112 were not picked up in the field to the west, nor was any trace of either ditch found in Trench 68 that was positioned to establish their presence or absence.
- 4.8.5 Ditch 7112 was, however, also picked up in Trench 72 to the east (Fig. 13). Although recorded as a single feature, soilmark 7202 is likely to represent several different cuts. It was not possible to obtain a full cross-section of this feature with a slot at right angles to its southern edge, but it was at least 2.9m wide and was not bottomed, excavation halting at a depth of 0.52m within the feature where this and the overburden deposits combined had reached the 1m deep excavation limit (Fig. 14). All of the exposed fills were believed to represent deliberate backfilling episodes, but there were no finds to date the feature. The latest fills exposed were at the north end of the intervention, and may belong to a feature cut into the ditch, as there is a different orientation on the north side of the soilmark, perhaps indicating a later feature that extended beyond the line of the ditch.
- 4.8.6 Another linear soilmark crossed the trench just south-west of ditch 7202 on a perpendicular alignment, and was numbered 7207. This corresponded broadly to the line of a cropmark ditch running north-south. A sizeable gap was shown on the cropmark plot between the north-south cropmark and the WSW-ENE one to its north, but the exposed north-south ditch continued as far as the other ditch. Ditch 7207 was only recorded in plan, and the intersection between this and 7202 lay just outside the trench, so no relationship was established. The cropmark corresponding to 7207 continued south into Trench 77, where it was excavated as ditch 7706 recut as 7703, and contained late Iron Age/early Roman pottery.

- 4.8.7 Although the WSW-ENE cropmark boundary corresponding to 7112 and 7202 was plotted as continuing eastwards, no corresponding features were identified in Trench 73 or in Trenches 94 or 95 east of that (Fig. 13; Fig. 4). However, ditch 7302 was identified and matches a cropmark ditch running roughly north-south along the same line (Fig. 13). It was 1.8m wide and 0.5m deep, with a steep-sided, concave profile containing two fills resulting from natural silting (Fig. 14), neither of which produced any finds.

## 4.9 Trenches 74 and 76

- 4.9.1 Trenches 74 and 76 lay south-west of Trench 71 and south of Trench 68 in the very south-west corner of the site (Fig. 4). Trench 74 was targeted on two WSW-ENE aligned linear cropmarks, and revealed two correlating ditches, 7404 and 7402 (Fig. 15). As in Trenches 71 and 72 to the north-east, there was an offset between the plotted and actual locations of these features.
- 4.9.2 The more northerly ditch, 7404, was over 3m wide, but could only be excavated to a depth of 0.6m within the feature where this reached the 1m overall depth limitation. The upper fills varied between clean and gravelly layers, all indicating a sequence of natural silting (Fig. 14; Plate 6), with partial gleying indicating at least seasonal waterlogging. The uppermost fill, 7408, contained six sherds of Roman pottery weighing 115g. A probable continuation of this ditch was found in Trench 77 to the east, where it joined the rectilinear ditch system already described in Trenches 71-73.
- 4.9.3 By contrast ditch 7402 was 1.88m wide but only 0.3m deep, with a broad shallow concave profile. It contained two fills of naturally silted material, but there were no finds, and is likely to form part of a boundary or enclosure ditch.
- 4.9.4 Two sub-circular pits were excavated immediately to the south of ditch 7402. Pit 7409 was larger, 1.24m long and 0.24m deep, and contained an undated and relatively sterile single deposit (Fig. 14). The adjacent pit, 7411, was only 0.54m long but of similar depth, and contained a darker more organic deposit that yielded a sherd of post-medieval pottery. A third, unexcavated pit, 7414 was located approximately 8m to the north of ditch 7402.
- 4.9.5 Located in the centre of the trench, and just north of pit 7414, was a large deposit (7413), measuring c 11m wide. Due to localised flooding in the area it was not possible to excavate this deposit.
- 4.9.6 Trench 76 lay south-east of Trench 74, and there were no cropmark features targeted by this trench (Fig. 15). Stripping revealed a large northwest-southeast aligned boundary feature, comprising at least five intercutting ditches, 7609, 7611, 7607, 7605 and 7603. All were shallow with concave profiles, the largest, 7611 measuring only 0.42m deep (Fig. 17). All had single fills and, as in ditch 7404, the ditch fills were somewhat gleyed in appearance (Plate 7). None of the ditches produced any artefactual evidence.

## 4.10 Trench 77

- 4.10.1 Trench 77 was one of a group of four trenches south of Trenches 72 and 73, and east of Trench 74 that targeted a dense area of cropmarks (Fig. 4). Trench 77 was a 20m x 10m area located to investigate the junctions of five linear cropmarks and a penannular cropmark thought likely to represent a house enclosure, while Trenches 78, 79 and 80 were standard 30m x 2m trenches to the east and north-east of this (Fig. 16).
- 4.10.2 Trench 77 found ditches corresponding to all of the linear and penannular cropmarks, and also revealed additional arcs of penannular gully and linear gully (Plate 8). On the western side of Trench 77 was a large north-south aligned linear feature, comprising ditch 7705 and a broader and slightly deeper recut, 7703 (Plate 9). This boundary feature is a continuation of the cropmark that extends to the north into Trench 72, where it corresponded to feature 7207. A single sherd of Roman pottery was recovered from deposit 7706 in ditch 7705, while 7704, the fill of 7703, yielded more than 500g of late Iron Age to early Roman pottery and a fired clay firebar from a pottery kiln.
- 4.10.3 In the northwest corner of the trench, ditches 7703 and 7705 are joined by an east-west aligned linear feature, 7725. This was not excavated, but is on the same line as ditch 7404 to the west, and like it was over 3m wide, so may represent a continuation of this. At the southern end, ditch 7703 intersected with curvilinear boundary ditch 7720. The intersection was not excavated, but it is likely that 7703 was later. Further east a cut was excavated across 7720, which was 1.5m wide but only 0.36m deep, with gently sloping sides and a concave base, and a single, sterile homogenous fill.
- 4.10.4 Surrounded by ditch 7720 in the southwest corner of the trench, and also apparently cut across by ditches 7703 and 7705, was a short arc of narrow curvilinear ditch (7722) that extended beyond the excavation. Although unexcavated, the curvature and dimensions of the feature would be consistent with a roundhouse gully.
- 4.10.5 Just north of ditch 7720 a penannular cropmark gully had been plotted, whose western two-thirds, including most of the south-east entrance, was targeted by the trench. Only the westernmost part of this proved to correspond to surviving features, which comprised gullies 7711 cut by 7709 (Figs 16 and 17). Ditch 7711 had steeply sloping sides and a wide flattish base with a slightly concave profile, and a single fill that did not contain finds. It was truncated to the west by a distinct circular shallow pit, 7707 (Plate 10). There were three fills; the main one (7708) was a layer of burnt flints and charcoal, which also contained a struck flint, but there were no other finds. An environmental bulk sample, Sample 2, was taken from the fill. A thin gravelly spread including burnt flint and darkened by charcoal from 7708 below was found in the top of the pit (7715). This appears to have spread beyond the confines of the pit (see Fig. 17 section 7702), so was probably a layer rather than simply a pit fill. It was very similar to layer 7719, which was a spread found across part of the interior of the penannular

enclosure (Fig. 17 Sections 7701-3), and the two may both have been parts of the same layer.

- 4.10.6 On the east side ditch 7711 partly truncated a single post hole, 7713, which was otherwise sealed by layer 7719 (Fig. 17 Section 7701). Neither the fill of the posthole nor layer 7719 contained finds.
- 4.10.7 Cutting across pit 7707, layer 7715 and gully 7711 was steep-sided, curvilinear ditch 7709 (Fig. 17 Sections 7701 and 7702; Plate 10). It contained a single fill, 7710, from which fragments of burnt clay, possibly wattle daub, were recovered. Ditch 7709 runs just inside the line of 7711, and has a similarly curvilinear plan, so probably represents a later phase of the roundhouse gully.
- 4.10.8 Inside the area surrounded by 7711 and 7709 was a third arc of gully, ditch 7723, which was recorded in plan but not excavated, although a struck flint was recovered from the surface. A short length of straight north-south gully 7724 was also seen but not excavated (Fig. 16).
- 4.10.9 Ditch 7717 corresponded to the west and north sides of a rectilinear cropmark boundary feature, and intersected with 7720, 7711, 7709 and the unexcavated gullies 7723 and 7724. The intersections were not investigated, but further east a cut into this gully revealed that it had steep sides and a narrow concave base (Fig. 17; Plate 11), and contained a single naturally accumulated fill (7718) that yielded four abraded sherds of middle to late Iron Age pottery. Ditch 7717 was apparently cut into layer 7719, which must therefore have extended across much of the northern half of the interior of the penannular enclosure. This relationship appears to show that the penannular enclosure was earlier than 7717, and presumably also of Iron Age date.
- 4.10.10 The cropmark information indicates that ditch 7717 continued eastwards and intersected with another penannular gully west of Trench 78, but it was not picked up in this trench, suggesting that the cropmark evidence was accurate in showing it ending short of Trench 78. Further to the east in Trench 79 ditch 7904 lay approximately on the same line, but no definite link can be made between these features.

## 4.11 Trench 78

- 4.11.1 Trench 78 lay north-east of Trench 77, and was located to investigate a cropmark penannular enclosure at the south and a rectilinear cropmark enclosure to the north (Fig. 16). Ditches corresponding to both cropmark features were found, although there was an offset between their plotted and their actual locations, together with a cluster of discrete features and two probable ditch termini between the two that were not visible as cropmarks.
- 4.11.2 East-west ditch 7823 matched the south side of the rectilinear cropmark enclosure. The ditch was 2.1m wide and nearly 0.5m deep with gently sloping sides and a pointed base (Fig. 17), and was filled by two naturally accumulated deposits, 7824 and 7825. A single small fragment of middle Iron Age pottery was recovered from the upper fill, 7825.
- 4.11.3 Ditch 7804 close to the southeast end of the trench corresponded to the penannular cropmark enclosure ditch (Fig. 16). It was 1.3m wide and 0.42m

deep (Fig. 16), with convex sides leading down to a narrow base (Plate 12), and contained a small primary silting (7805), overlain by a homogenous deposit of naturally silted material (7806). Fragments of struck flint and three sherds of middle Iron Age pottery were recovered from this fill. Sample 1 was taken from 7806, and recovered small fragments of charcoal and charred goosefoot seeds, and a burnt flint.

- 4.11.4 A single posthole, 7802 was exposed a little more than 1m to the southeast of ditch 7804. It measured just 0.1m deep and contained a single fill with a few charcoal flecks, but not yielded no dating evidence of or other artefacts.
- 4.11.5 To the northwest of ditch 7804 was a cluster of pits of varying size and shape. The largest of these, 7809, was 1.75m x 0.86m in plan, was 0.53m deep and was bowl-profiled, with sloping sides leading down to a concave base (Fig. 17 Section 7802; Plate 13). This pit contained two relatively sterile deposits derived from natural silting and erosion. This pit was partially truncated by the termini of narrow gullies 7810 and 7807, the first running in from the west, the second and later from the ENE. Pit 7809 was also truncated by the north end of another pit 7818 (the last not in section). None of these features produced any artefacts.
- 4.11.6 The remaining pits all initially appeared to be of geological origin, but close inspection identified rare charcoal fragments in the fills, and worked flints were recovered from the surface of both 7814 and 7822. Pits 7814 and 7816 were excavated, and both were of similar depth and had similar bowl-profiles to pit 7809 (Fig. 17 Section 7803). Pit 7814 was cut by 7816, from whose single fill no finds were recovered. The remainder of the pit cluster comprised 7820, 7821 and 7822, none of which were excavated.

## 4.12 Trenches 79 and 80

- 4.12.1 Trench 79 lay east of Trenches 77 and 78, and was positioned to cross a linear cropmark running east from the penannular gully crossed by Trench 78 (Fig. 16). Trench 80 lay north of 79 in an area devoid of cropmarks. Trench 79 exposed two east-west ditches some 6.5m apart, 7902 south of 7904. Both ditches were narrow and shallow, 7902 surviving only 0.21m wide and 0.06m deep, ditch 7904 some 0.44m wide and 0.15m deep (Fig. 19). Both features contained single sterile fills deposited by natural silting. It is possible that that these ditches formed a trackway.
- 4.12.2 Neither ditch corresponded to the line of the linear cropmark, which ran midway between them. While an offset of 1-2m had been observed in some other trenches in LTC21 and LTC22 to the south, an offset of this magnitude makes it unlikely that either of the revealed ditches represent the cropmark. There was, however, a second parallel linear cropmark south of the one crossed by Trench 79, and the gap between these cropmark features was very similar to that between 7902 and 7904, so the possibility that the revealed ditches correspond to these cropmarks cannot be entirely discounted.
- 4.12.3 Ditch 8002 was the only feature revealed in Trench 80, and ran on a north-east to south-west alignment. It was 0.78m wide and 0.24m deep, with a concave profile and a single naturally accumulated fill. No finds were recovered from the fill and this ditch was not previously identified as a

cropmark. From its alignment, it is just possible that gully 7807 represents a continuation, but given the distance between these trenches (more than 45m) this is somewhat speculative.

## 4.13 Trench 81

- 4.13.1 Trench 81 lay east of Trench 79 in an area devoid of cropmarks (Fig. 4), and exposed a single pit and a gully either side at the south end (Fig. 18). The small pit, 8104, was 0.24m across and 0.1m deep (Fig. 19), and contained a single homogenous fill (8105) from which a small sherd of late Iron Age or Roman pottery was recovered. It was cut on the north side by a small ditch or gully 8106, which was aligned NNE and terminated within the trench. This measured 0.38m wide and was only 0.16m deep, with a single fill that produced a small fragment of fired clay.
- 4.13.2 South-east of the pit was a slightly larger ditch or gully 8102, which ran into the trench on a north-east alignment, and also terminated within the trench. This ditch was 0.5m wide and 0.1m deep with a flat base (Fig. 19). It contained a single sterile fill.

## 4.14 Trench 87

- 4.14.1 Trench 87 was located on the east side of the site, north-west of Trench 88 and north of Trench 89, and was orientated WSW-ENE in an area devoid of cropmarks (Fig. 4). A single pit (8704) was found midway along the northern edge of the trench, which contained a single fill of charcoal and fragments of possibly cremated bone (8705). The trench was therefore extended by 0.5m x 0.5m to expose the full extent of the pit (Fig. 20). Although a portion of the feature had been truncated during the excavation of the trench, it measured 0.42m in diameter and 0.2m deep.
- 4.14.2 The upper part of the pit seen in section was heavily disturbed, so that both charcoal and bone fragments were evident in the base of the overlying subsoil 8708 (Fig. 19 Section 8700). The pit was excavated in spits (Samples 5-7), and further samples were taken from the subsoil (Samples 8, 11 and 12), and from the topsoil (Sample 4) over and around 8704. A couple of fragments of cremated bone were recovered from sample 8, but could not be identified as human. No fragments of cremated bone more than 2mm across were recovered from the samples from 8705, the fill of pit 8704. Both these and the charcoal may have been introduced by disturbance of the adjacent pit. A metal find recovered from the pit was given the number SF 5, and further fragments of both copper alloy and iron came from the fill. These metal finds have all proved to be of modern date.
- 4.14.3 When the trench was extended, an adjacent spread 8707 was also exposed (Fig. 20). This contained a large amount of charcoal, and a single piece of struck flint was recovered from the surface. On site it was considered possible that this was the fill of a separate feature, perhaps a cremation, but it was very similar to 8708, the disturbed fill of pit 8704 in the base of the subsoil. As rabbit bones were found in 8708, it is possible that the disturbance of 8704 was partly due to a rabbit burrow, and 8707 may have been fill spread into this, into which metal rubbish was later thrown. The date and original function of pit 8704 remains unknown, although the

absence of clearly identified human bone, and the very small quantities recovered, suggests that it was not a cremation pit.

- 4.14.4 An irregular soilmark was also exposed at the west end of the trench, which proved to be of natural origin.

## 4.15 Trench 96

- 4.15.1 Trench 96 lay north of Trench 81, and some way east of Trench 80 towards the south end of the site (Fig. 4). It was orientated NNW-SSE in an area devoid of cropmarks, but revealed a recut ditch crossing the southern half of the trench on an ENE-WSW alignment, together with a cremation pit to the south and a tree-throw hole or further ditch to the north (Fig. 18).
- 4.15.2 The profile of ditch 9606 was broad, with steep sides leading to a flat bottom, and then sloping sides to a pointed base north of the centre of the ditch (Fig. 19). On the north edge it cut a band of gravel (9609), which when tested proved to be a variation in the natural. The fill of the lower V-profiled part of the ditch was 9605, which was without finds. The upper fill 9604 was a light grey clayey sand that filled all of the wider part of the ditch, except at the south edge, where the fill was more clayey, and was numbered 9608. Both fills 9605 and 9604 showed evidence of partial gleying. Three small sherds of Roman pottery were recovered from the upper fill.
- 4.15.3 The interpretation made on site was that both 9605 and 9504 belonged to the recut ditch 9606, and layer 9608 on the south to earlier ditch 9607, although the cut line between them was slightly uncertain (Fig. 19). Some 65m to the ENE, ditch 9913 recut as 9902 in Trench 99 was of similar dimensions and on the same alignment, and may represent a continuation of this boundary ditch. It too had the earlier and shallower cut on the south.
- 4.15.4 Pit 9610 was located 2.2m to the south of ditch 9607, and was circular, 0.25m in diameter and was heavily truncated, survived only 0.10m deep. It contained the truncated base of a ceramic vessel, numbered 9611, which was Roman in date. Within the vessel were the remains of a cremation deposit (9612), comprising charcoal and cremated bone fragments (Plate 14). The backfill of the pit around the vessel was a dark grey silty clay, and was numbered 9613. No other finds were recovered from this feature.
- 4.15.5 Feature 9602 had an irregular plan and profile, and was probably a three-throw hole. It had a single fill of gleyed clay sand from which a Neolithic or early Bronze Age flint knife was recovered.

## 4.16 Trench 97

- 4.16.1 Trench 97 lay north-east of Trench 96, and was orientated ENE-WSW in an area without cropmarks (Fig. 4). A possible buried soil or colluvial deposit, layer 9703, was exposed over a distance of 9m at the southwest end (Fig. 18; Plate 15), and continued beyond the end of the trench. Layer 9703 was 0.35m thick at the deepest point, and consisted of a brownish grey silt, with a notable concentration of gravel towards the base. Two sherds of Roman pottery were recovered from the fill.
- 4.16.2 This end of the trench was located in a slight dip in the topography that had presumably allowed material to accumulate. It is possible that this was

originally part of a trackway that contributed to the erosion of the ground surface and creating an area for this deposit to accumulate.

## 4.17 Trench 98

- 4.17.1 Trench 98 lay south of Trench 97 and east of Trench 81 on the south edge of the site (Fig. 4), and targeted a discrete cropmark north of a cropmark rectilinear small enclosure, which could not be investigated directly due to a safety exclusion zone for live services. No archaeological feature was found corresponding to the cropmark, but a pit (9831) was exposed 5m further west, and the trench uncovered an east-west ditch and two pits towards the west end, the ditch returning south at its west end (Fig. 18).
- 4.17.2 Pit 9831 was not excavated, but further west pits 9817 and 9819 were found on the north side of the trench within a large soilmark numbered 9816 that extended for 4.6m along the trench. This soilmark was variable in composition, with areas of cleaner silt and others that were more sandy or gravelly, and it was decided that detailed excavation would be required to clarify the sequence of features within it, which lay beyond the scope of evaluation. A slot was however dug across it adjacent to the north-west edge of the trench, and this revealed parts of pits 9817 and 9819, both of which were filled with sterile naturally accumulated material. The slot also showed that in places the soilmark consisted of a thin layer of silty sand some 0.12m thick (Fig. 19 Section 9803). Both struck flints and middle Iron Age pottery were recovered from the soilmark under the number 9816.
- 4.17.3 Pits 9817, 9819 and deposit 9816 were all truncated by a possible ditch terminus, 9821 (Fig. 19). It had a broad U-shape profile with steep sides, containing a sequence of sterile, naturally accumulated fills. Each of the deposits had elements of iron panning resulting from intermittent waterlogging or the movement of water through this feature.
- 4.17.4 The southern edge of deposit 9816 was truncated by east-west ditch 9802. It had near-vertical sides and a flattish base, with three sterile, partially gleyed fills, and was recut along its southern side by ditch 9806 (Fig. 19). Excavated to a depth of 0.62m, the full profile of this later ditch could not be established as it extended below both the water table and the depth limitation for excavation within the trench, although the south side was flattening out, suggesting that it may not have been much deeper. Ditch 9806 was filled with a sequence of silty sands or gravels that had accumulated naturally (9807-9812), each displaying signs of at least seasonal waterlogging. A substantial quantity of late Iron Age and early Roman pottery was recovered from deposits 9808, 9809, 9810, 9811 and 9812.
- 4.17.5 A linear feature numbered 9813 (possibly a mole drain) was recorded cutting across the top of deposit 9812.
- 4.17.6 West of land drain 9829, ditch 9806 appears to have continued beyond the southwest end of the trench. A bulge on the south side was numbered 9830, but was not excavated. Like the other archaeological features in this trench, it too had a gleyed appearance. Ditch 9802 recut as 9806 was on a very similar alignment and line to the north side of the cropmark enclosure 8m



further east, and it is possible that they were part of a larger enclosure system.

## 4.18 Trench 99

- 4.18.1 Trench 99 was east of Trench 97 and north-east of Trench 98 at the south end of the site (Fig. 4), and was aligned NNW-SSE in an area without cropmarks. The trench revealed two recut ditch sequences, 9904-6 on the north and 9902/9913 on the south (Fig. 21). Ditches 9904-6 were aligned east-west, and 9902/9913 ENE-WSW.
- 4.18.2 A large ditch was recorded at the southern end of the trench. Ditch 9913 on the south side was the earlier cut, and had a single fill of blue-grey clay and sand that was without finds (Plate 16). It was truncated to the north by a larger ditch 9902, which was 1.75m wide. The full depth of 9902 was not observed due to restrictions on the depth of excavation, but it was at least 0.6m deep. The upper two fills both exhibited evidence of gleying, leading to the unusual preservation of animal bone. The final upper fill (9903) produced several fragments of Roman pottery.
- 4.18.3 Towards the north end of the trench, ditch 9904 had a gently sloping edge suggesting a broad concave profile, but was truncated to the north by ditch 9905 (Fig. 18). Ditch 9905 was excavated to a depth of 0.6m, but could not be bottomed due to health and safety restrictions. It contained multiple fills of naturally silted material and evidence of post-depositional gleying. Upper fill 9909 contained a single sherd of Roman pottery and the layer below, 9910, yielded a fragment of coarse flint-tempered late Bronze Age pottery.
- 4.18.4 Ditch 9906 ran on a parallel alignment, immediately to the north of 9905, and no clear relationship was established between them. This was a much smaller feature, just 0.26m wide and 0.12m deep with a single deposit of grey, silty sand that did not contain finds (Fig. 19). No trace of these ditches was found in Trench 100 to the east

## 4.19 Trench 100

- 4.19.1 Trench 100 lay east of Trench 99, and was aligned WSW-ENE in an area without cropmarks (Fig. 4). Removal of topsoil and subsoil revealed a continuous soilmark approximately 19m wide, and north-east of this soilmark there were a couple of pits or ditch terminals in the south-east edge of the trench, and an irregular soilmark north-east of that (Fig. 21). A slot 9m long was dug across the two pits or ditch termini and into the north-east side of the large soilmark, extending along the south-east edge of the trench (Plate 17). The slot revealed that this part of the soilmark was the result of multiple intercutting features, sealed by a single deposit (10006).
- 4.19.2 The features recorded within the main soilmark were multiple northwest-southeast aligned ditches, the southernmost being 10007, cut on the north-east by 10009, which was in turn cut on the north-east by 10015. The north-easternmost ditch was 10011, which was also cut by 10015 (Fig. 22). Each of these features had a single fill, and Roman pottery came from the fills of 10007 and 10009. The full profile of ditch 10007 was not reached as it lay beneath the 1m depth limit for excavation, although the south-west side appeared to be turning in, suggesting that the ditch was not much deeper.

Groundwater was encountered during the excavation of these features, and gleying of their fills also indicated they were waterlogged, at least on an occasional basis.

- 4.19.3 The tops of the fills of all of these features were level with one another, suggesting that they had been truncated by a large, flat-bottomed cut 10003 that contained successive fills 10004, 10005 and 10006 (Fig. 22). Layer 10004 was confined to the north-east end, overlying three of the four ditches, which 10005 extended a little further south-west, and also overlay the fill of 10007. These grey silty sand fills were without finds, but the brownish-grey silty sand that filled the rest of this feature (10006) contained Roman pottery. The full extent of cut 10003 was not established, as it continued south-westwards beyond the ditches and beyond the end of the excavated slot. At the north-east end feature 10003 cut feature 10013, whose V-profile suggested it may have been the terminus of another ditch rather than a pit. Ditch 10013 had one fill, which also produced a sherd of Roman pottery.
- 4.19.4 Ditch 10013 cut feature 10017, which was shallow, and had a single sterile fill like that of 10019. Both are likely to be either the remains of tree-throw holes or variations in the geology.
- 4.19.5 If the alignment of ditches 9904 and 9905 is extrapolated to the east, it is possible that they continued into trench 100. Although not specifically identified, they may have been sealed beneath, or simply indistinguishable in plan from deposit 10006.

## 4.20 Trenches 101 and 103

- 4.20.1 Trench 101 lay south of Trench 100 on the south edge of the site, and was positioned both to cut across the north side of a rectilinear enclosure cropmark that appeared to continue beyond the limits of the site, and to include a discrete cropmark feature inside the enclosure (Fig. 4). A recut ditch was found slightly offset but otherwise corresponding to the plotted cropmark enclosure. The discrete cropmark proved to reflect a variation in the natural geology (Fig. 21). A pit was however found outside the enclosure to the north-west.
- 4.20.2 Ditch 10102, whose upper fills were believed to lie within recut 10104. form the northern edge of a rectilinear enclosure. The east side of the enclosure was revealed in Trench 103 and recorded as ditch 10309.
- 4.20.3 Ditch 10102 was not fully excavated due to its depth, but it measured at least 0.66m deep and 2.4m wide (Fig. 23; Plate 18). Both 10102 and 10104 were filled with homogenous naturally accumulated deposits containing Roman pottery; the upper fills (within recut 10104) contained 314g of middle to late Roman pottery. Ditch 10309 also contained Roman pottery dating to the 2nd and 3rd centuries throughout its fills.
- 4.20.4 The northern edge of ditch 10104 was truncated by a sub-circular feature 10107, possibly a pit (Fig. 21). Although no dating evidence was recovered from this feature, it was filled with a loose, deliberate backfill, so was possibly of morerecent date.

- 4.20.5 Feature 10109 was recorded in plan and is probably a large pit. It had a grey, slightly gleyed upper fill and lenses of charcoal visible at the surface.
- 4.20.6 Trench 103 lay east of Trench 101, and was arranged to cut across both the east side of the cropmark enclosure investigated by Trench 101 and the west side of a smaller rectilinear enclosure adjacent to it (Fig. 21). Ditches corresponding to both of the cropmark enclosures were found, and two smaller ditches or gullies not evident as cropmarks, one between the two enclosures, the other within the eastern enclosure.
- 4.20.7 Ditch 10309 represented the east side of the larger cropmark enclosure, and was 1.5m wide and 0.5m deep, with sloping sides and pointed base creating a wide V-shaped profile (Fig. 23). There were three fills (10310-10312), all containing middle Roman pottery, and the sequence of fills was from west to east, perhaps indicating that a bank had lain on the inner side of the enclosure ditch. Small ditch or gully 10313 truncated 10309 on a diagonal northwest-southeast alignment. It contained a single sherd of Roman pottery, though this may have been residual.
- 4.20.8 Ditches 10303 and 10306 correlate with the western side of a second rectilinear cropmark enclosure to the east of 10309. Ditch 10303 was the earlier cut and had a wide concave profile, recut by larger ditch 10306 on the west (outer) side (Plate 19). The recut was nearly 2m wide and 0.62m deep, with steep curving sides and a narrow cupped base (Fig. 23). Both phases of ditch had two fills, and appear to have remained open and silted up gradually, incorporating several sherds of Roman pottery.
- 4.20.9 Pit 10315, measuring 1m across and 0.4m deep, was recorded at the eastern end of the trench, potentially within the enclosure defined by ditches 10303 and 10306 (Fig. 23). The fill of the pit appears to have accumulated naturally and did not produce any artefacts. It was cut through by a small, broadly north-south aligned ditch, 10317. This also contained a sterile fill that had accumulated by natural silting.

## 4.21 Trench 102

- 4.21.1 Trench 102 lay north of Trench 103 and east of Trench 100, and was orientated NNW-SSE in an area devoid of cropmarks. The trench revealed a single ditch towards the south end, which was orientated ENE-WSW. Ditch 10202 was substantial, 2.8m wide and 0.71m deep, with steep sides and a wide flat base, and contained a sequence of three gleyed fills (Fig. 23; Plate 20). The earliest and main fill (10203) produced several fragments of animal bone and late Iron Age or early Roman pottery. Animal bone was also recovered from the overlying fill (10204), and sherds of Roman pottery were recovered from both upper fills (10204) and (10205). The projected line of the ditch does not appear to have a continuation in Trench 106 to the east. It is also unclear if any of the ditches recorded in Trenches 99 and 100 to the west correlate to this ditch.

## 4.22 Trenches 88, 104 and 105

- 4.22.1 Trench 105 lay east of Trench 103, Trench 104 north of 105 and east of Trench 102, and Trench 88 north of 104 (Fig. 4). All three trenches were laid out to cross a linear cropmark boundary on a NNW-ESE alignment.

Trench 105 was also positioned to cross a narrow rectilinear enclosure just east of the cropmark boundary, and Trench 104 to cross another north-south linear cropmark west of the main boundary. Ditches corresponding to the cropmark boundary were found in all three trenches (Fig. 20 ditch 8802, Fig. 21 ditch 10403 and Fig. 25 ditches 10403 and 10502), and ditches were also found corresponding to the rectilinear enclosure in Trench 105, but no archaeological feature was found corresponding to a north-south cropmark targeted within the western part of Trench 104.

- 4.22.2 The linear cropmark boundary matches a boundary marked on the 1873 Ordnance Survey map. Ditches 10403 and 10502 were excavated, and it proved to be 1.1-1.25m wide and 0.28-0.46m deep, with a single fill in each trench (see Fig. 26 Section 10500). Post-medieval brick and an iron sickle bar mower tooth dated later 19th or 20th century were recovered from 10404, the fill of 10403. The ditch in Trench 88, and a narrow parallel gully alongside on the west, were not investigated further.
- 4.22.3 Ditches 10504 and 10508 coincide with the western and eastern sides of a narrow rectilinear cropmark. Ditch 10508 had a broad V-profile with sloping sides, 10504 more gently sloping sides, but both features had shallow profiles and single fills derived from natural silting (Plate 21). Two large sherds of Roman pottery totalling 131g and an iron nail, probably Roman, were retrieved from the fill (10509) of 10508.
- 4.22.4 Feature 10506 was only partly exposed within the trench just east of enclosure ditch 10508. It was relatively substantial, 1.58m wide and 0.59m deep, with steep sides and a wide flattish base (Fig. 26). It contained 35g of middle to late Roman pottery, an iron nail and several pieces of worked flint, including an early prehistoric core. This feature may have been either a pit or (less likely) a ditch terminus
- 4.22.5 At the north-west end of the trench there was a broad soilmark numbered 10512. This was not excavated, but may possibly have been a ditch on a north-east to south-west alignment. It was not related to any cropmark features previously identified.
- 4.22.6 Two possible postholes were investigated to the southeast of ditch 10506, but both were interpreted as the result of bioturbation.

## 4.23 Trenches 109 and 116

- 4.23.1 Trenches 109 and 116 were located in the easternmost part of the site, Trench 109 close to the northern edge and Trench 116 to the south east, in an area without cropmarks. Both were orientated NNW-SSE, and between them they revealed a series of six parallel linear features aligned ENE-WSW at regular intervals of between 7.6m and 7.8m (Fig. 24). Three of the six were excavated: the two southernmost (11603 and 11605) in Trench 116 and the southernmost (10903) in Trench 109.
- 4.23.2 Ditches 11603 and 11605 were of similar width, being 0.56 and 0.65m respectively, and both had steep, near vertical sides, though neither could be bottomed for safety reasons due to the thickness of overburden in this area (Fig. 26). Their upper fills were both mixed, deliberate backfill deposits

of mixed orange and grey silty clay, and a single sherd of Roman pottery was recovered from 11604, the fill of 11603.

- 4.23.3 Ditch 10903 was notably smaller and shallower, just 0.4m wide and 0.16m deep, with a more concave profile, but had a similar greyish yellow silty clay fill. There were no finds.
- 4.23.4 The arrangement of these features at regular intervals, the profiles and sizes and the type of mixed clayey fill, together with the Roman pottery, is strikingly similar to the ditches in Trenches 21, 22 and 23 in the north of the site, and it is likely that they performed a similar function. None of the features in Trench 109 were seen to continue into Trenches 107 or 108 to the west, or into Trenches 110 or 111 to the east, and similarly none of those in Trench 116 continued in Trenches 114 or 115 to the west, or in Trench 117 to the east, indicating that they were all of limited extent (Fig. 4).

## 4.24 Trench 111

- 4.24.1 Trench 111 lay in the easternmost part of the site, north-east of Trench 116, and was orientated NNW-SSE in an area devoid of cropmarks (Fig. 4). The only feature revealed within the trench was a soilmark (deposit 11103) at the southern end of the trench (Fig. 24). Due to waterlogging here it was difficult to ascertain the full extent of the deposit accurately, but it appeared to be an irregular north-south spread. A slot across this deposit showed that it had a maximum thickness of 0.25m. The origins of this deposit remain unclear, but a small fragment of late Bronze Age pottery and some fragments of bone were recovered from the deposit.

## 4.25 Trench 118

- 4.25.1 Trench 118 lay north-east of Trench 105 in the south-eastern part of the site, and was orientated NNW-SSE in an area without cropmarks (Fig. 4). Four linear features were exposed crossing the southern half of the trench, the two broader soilmarks on an east-west alignment, the two narrower soilmarks on a more WSW-ENE alignment (Fig. 25). A discrete soilmark was also found, but on closer examination was shown to be of natural origin.
- 4.25.2 The southernmost feature (11809) was 1.64m wide, but proved to consist of a ditch with steep sides and a flattish base that was 0.54m deep and only 0.8m wide, with a shallow shelf on the northern side (Fig. 26). It had been filled by natural silting and there were two distinct deposits, the upper of which (11811) contained four small sherds of middle to late Iron Age pottery.
- 4.25.3 Ditch 11807 was located approximately 1.6m to the north, and was 0.98m wide and 0.28m deep, with a shallow concave profile and a single sterile fill (Fig. 26).
- 4.25.4 A further 3.6m to the north of 11807 the largest linear soilmark was numbered 11812. This measured 2.17m wide, but was not excavated, and no finds were recovered from its surface.

- 4.25.5 The most northerly ditch was 11802, and this was excavated. It was 0.6m wide and 0.18m deep, with sloping sides and a flat base (Fig. 26). There were two fills, the earlier down the north side of the ditch, and both were sterile.
- 4.25.6 No continuations of any of these ditches were seen either in Trench 106 to the west or in Trenches 119 and 120 to the east, so they had all presumably either terminated or turned before this.

## 4.26 Trenches 119 and 125

- 4.26.1 These two trenches lay respectively east and south-east of Trench 118 in an area devoid of cropmarks in the south-east part of the site (Fig. 4). Each trench revealed one linear feature (ditches 11902 and 12503) belonging to a single north-south boundary (Fig. 25). Both interventions into the ditch revealed similar profiles, vertical on the west side and steeply sloping on the east, and although 12503 was not quite bottomed, both had broad bases with rounded edges (Fig. 26; Plates 22 and 23). Both ditches contained fills resulting from natural silting, but the sequence in ditch 12503 was more complex, indicating successive phases of natural slumping and silting. Both ditches yielded Roman pottery, with 22g from three separate contexts in 12503 and a single 14g sherd from ditch 11902.
- 4.26.2 The ditch was over 1.35m wide in both trenches, and at 0.6m or more deep, constituted a substantial boundary. The ditch was deeper in Trench 125, and the broad base of the ditch was clearly sloping quite steeply southwards, indicating that it also served a drainage function whilst creating a distinct boundary. No trace of a continuation was seen in Trench 108 to the north.

## 4.27 Trench 124

- 4.27.1 Trench 124 lay west of Trench 125 and south of Trench 118 on the south edge of the site (Fig. 4). A broad soilmark was exposed at the east end of the trench covering an area in excess of 8.5m wide (Fig. 25). A slot was dug across this, showing that it consisted of several large features, but due to the high water table in this area it was only possible to investigate these features to a depth of 0.4m, inevitably limiting their interpretation.
- 4.27.2 Feature 12404 was located at the western edge and measured 2.82m wide with sloping upper sides and a stepped profile that extended below the excavated depth (Fig. 27). The only exposed fill (12405), extended the entire width of the feature. It was initially recorded as a pit, but without exposing its full extent, it is difficult to be certain. Feature 12404 was truncated on its eastern edge by north-south aligned ditch, 12406, which had steeply sloping sides and a single fill. On its east side ditch 12406 also truncated the edge of 12402, another broad feature with stepped profile that continued below the depth of excavation. The ditch had removed the relationship between 12402 and 12404. The exposed fill of the west part of 12402 was 12408, but this was overlaid some 2m further east by deposit 12403, interpreted as a later fill of pit 12402. The fills of all the features were variants of greyish-brown sandy silt, and no artefacts were recovered from any of them.

- 4.27.3 It is possible that this was a small quarry later infilled and cut across by a boundary ditch. No continuation of ditch 12406 was evident in Trenches 113 or 108 further north, so this ditch may have ended or returned before this, possibly as one of the ditches in Trench 118.

## 4.28 Trench 123

- 4.28.1 This trench lay at the very east edge of the site, south-east of Trench 111, and was orientated WSW-ENE in an area devoid of cropmarks (Fig. 4). Stripping revealed one discrete feature (12303) some 2.5m in diameter and at least 0.5m deep. The single fill (12305) was a dark yellowish-brown silty clay that contained post-medieval brick, tile and fired clay.

## 4.29 Finds summary

- 4.29.1 **Pottery.** Some 283 sherds of pottery, weighing 3.98kg, were recovered from the evaluation. The pottery spans the prehistoric and Roman periods, from the single late Bronze Age to early Iron Age body sherd and the small group of middle Iron Age material in the south-west of the site to the more widely dispersed late Iron Age and Roman material. A single sherd of post-medieval pottery was also recovered.
- 4.29.2 **Ceramic building material.** this was a small assemblage, mostly flat tile of post-medieval date, but did include roman brick from trenches 98 and 101.
- 4.29.3 **Fired clay.** This was a small assemblage, mostly of indeterminate function, but included four fragments of 'bricks', probably firebars from a kiln or oven structures, found in Trenches 77, 98 and 123, and one structural fragment with a wattle impression from Trench 77.
- 4.29.4 **Worked flint.** A small assemblage of 25 struck flints and 86 fragments of burnt unworked flint weighing 536g were recovered from this evaluation. The struck flint was of early prehistoric or late Neolithic/early Bronze Age date, and was widely dispersed across the evaluation area. but there were three locations (focussed upon Trenches 75-78, 87-89 and 96-99) that appeared to have increased flint-related activity.
- 4.29.5 **Metal.** Although 126 items were recovered, many were fragmentary and unidentifiable pieces of iron, and the majority of identifiable iron fragments were nails. Other than a couple of Roman nails, all of the material was dated as post-medieval or modern.

## 4.30 Environmental summary

- 4.30.1 **Charred plant remains.** A total of 13 samples were recovered from the evaluation. Very few contained identifiable charred plant remains or charcoal, with the exception of pit 7707, pit 8704 and cremation 9610.
- 4.30.2 **Human bone.** Cremated bones of an older adolescent or adult were recovered from a pottery vessel in 9610, and a single cremated bone from middle Iron Age pit 7707.
- 4.30.3 **Animal bone.** A small assemblage of bones of domestic mammals was recovered from features, mostly of the late Iron Age and Roman periods.



## 5 Discussion

---

### 5.1 Reliability of field investigation

- 5.1.1 The archaeological features were reasonably well defined against the underlying Boyn Hill Gravel and head deposits, although several deposits were sample excavated to establish if they were of geological or archaeological significance. Wet weather and poor drainage did lead to prolonged periods of flooding episodes of silting in the trenches, but this was largely mitigated by systematic pre-excavation mapping of the features soon after the trenches were opened and prior to inundation.
- 5.1.2 A small number of trenches could not be excavated during this phase of investigation due to flooding or other constraints relating to health and safety. With the exception of Trench 75, the unexcavated trenches were designated for areas of low archaeological potential, with few if any features in the adjacent trenches. Inevitably, there remains a possibility that additional archaeological remains were not identified, but on balance, the potential is low.
- 5.1.3 Several features were not fully excavated as they extended below the safe working depth of 1m below ground level. However, the depths of these features can be confidently extrapolated based on the predictable profiles of any such features, limiting the impact of this factor.
- 5.1.4 However, groundwater was frequently encountered at a depth of approximately 0.8m below ground level across the site, particularly in the area of the Boyn Hill sand and gravels. It seems likely that where these permeable deposits were overlying the bedrock geology of London clay, a perched water table had developed within the gravels. Even if this was only a seasonal occurrence, the restricted depth of the investigations means that the presence of waterlogged deposits could not be established. Although the identification of possible gleyed deposits does suggest some potential for that such deposits to have been present.
- 5.1.5 There was a reasonable correlation between the aerial survey cropmarks and the archaeological features in some of the trenches, but this was not consistent across the site. Trenches 71, 72, 73, 74, 77, 78, 101, 103 and 105 all revealed features that had been indicated by the cropmarks. However, ditches 7603, 7605, 7607, 7609, 7611, 9606, 9607, 9904, 9905, 9902, 9913, 9806, 9802 and larger features such as 7413 and the clusters of intercutting features in Trenches 100 and 124 were not identified. Also, none of the horticultural drainage ditches from Trenches 17, 23, 22, 21, 5 and 6, or 109 and 116 were indicated as cropmark features.
- 5.1.6 Cropmark features were only recorded on the areas of Boyn Hill Gravel Member, but this is where the vast majority of the archaeological features were located. Archaeological features were sparse further north on the head deposits, and the fact that the possibly horticultural features did not show as cropmarks was probably due to the fact that they were backfilled with the deposits into which they were dug, making them very unlikely to create cropmarks.

- 5.1.7 Overall, although the cropmark features were reliable in identifying where the principal areas of archaeological activity were located, the density of archaeology was underrepresented by the cropmark evidence. This included the numerous discrete smaller pits and post holes that do not usually create recognisable cropmarks.
- 5.1.8 The archaeology across the site was generally truncated by ploughing, although the features were mostly preserved to a reasonable depth. In Trench 77, two thin layers overlying the natural were preserved that appear to belong to the late prehistoric settlement, suggesting that localised areas of better preservation exist at the south end of the site. The same was true in the field south of Stifford Clays Road (OCA 2020b). Nevertheless, comparison of the cropmark of the penannular enclosure in this trench with the revealed archaeology also suggests that the enclosure gully may have been partly removed by truncation. Preservation must therefore be considered as variable.

## 5.2 Interpretation

- 5.2.1 **Mesolithic/Neolithic.** Early prehistoric evidence was limited to a small number of worked flints. These included a Mesolithic or early Neolithic retouched blade from the ploughsoil of Trench 64 and an end scraper of the same date recovered from the surface of a small pit or tree throw in Trench 78.
- 5.2.2 The occurrence of this material in such small quantities suggests that activity during this period was little more than transitory. This is also consistent with previously recorded evidence within the vicinity, and with that from evaluation of the area south of Stifford Clays Road (OA 2020b).
- 5.2.3 **Neolithic and early Bronze Age.** These periods were also only represented by sparse struck flints. These included the backed knife from the ploughsoil of Trench 89 and late Neolithic or early Bronze Age knife recovered from tree-throw hole, 9602.
- 5.2.4 There were no features of these periods found by the evaluation, and no indication that either of the cropmark ring ditches were funerary monuments of these dates. The knife from 9602 is, however, of a type that is more frequently found in burial or ritual contexts, so it remains possible that such features may exist elsewhere on the site or has been removed by arable cultivation of the field.
- 5.2.5 **Iron Age.** Permanent occupation of the site appears to have begun in the middle to late Iron Age and was concentrated in the southwest of the site around Trenches 77 and 78. Both trenches revealed dense concentrations of features including pits, post holes and curvilinear ditches. Ditches 7709 and 7804 coincided with two penannular cropmark features previously identified as part of the Orsett Cropmark Complex. Given the presence of middle Iron Age pottery in 7804, it seems probable that these features represent the remains of drip gullies or enclosure ditches around roundhouses structures. In total, evidence for at least four such structures was identified in these two trenches.

- 5.2.6 **Roman.** Activity in the southwest area of the site then continued into the Roman period, as evidenced by a series of rectilinear enclosures in Trenches 72, 74, 77, 96 and 98 that produced late Iron age - early Roman pottery. A series of similar ditched enclosures were recorded along the southern edge of the site, broadly dating to the Roman period.
- 5.2.7 A notable concentration of activity was recorded around Trenches 101, 103 and 105. These trenches were targeted on three rectilinear cropmark features. The excavations produced a large proportion of the total pottery assemblage with the material predominantly dating to the 2nd and 3rd centuries.
- 5.2.8 Although no structural remains were recorded that dated to the Roman period, the pottery assemblage does demonstrate access to the imported wares, and the use of table wares was also evidenced. Overall, the material was in moderate condition suggesting that domestic activity had occurred within the site or in close proximity.
- 5.2.9 Away from the main settlement focus there was evidence for possible horticultural land use provided by a number of drainage features, similar to lazy beds. These were present in two separate locations, one to the east of the settlement in Trenches 109 and 116, and the second, towards the northern edge of the site in Trenches 5, 6, 17, 21, 22 and 23. Small quantities of Roman pottery were recovered from the backfill of the ditches in Trench 21. This appears to indicate that whilst the main settlement activity was focused on the more freely draining sand and gravels, on the higher ground to the south, the more marginal areas were also utilised and exploited during the Roman period.
- 5.2.10 A single cremation urn was recorded in Trench 96. Although the fabric of the vessel was identified as Roman, truncation of the feature meant that the form could not be dated more precisely.
- 5.2.11 The evidence for the Iron Age and Roman periods should be considered in conjunction with the cropmarks visible south of Stifford Clays Road (Fig. 2), which show that this is part of the same settlement. The results of the evaluation of the area to the south (OA 2020b) have revealed less confirmed activity of middle Iron Age date, but a complex of enclosures, field boundaries, pits and postholes were dated to the late Iron Age or early Roman period, and continued in the middle Roman period, although there was no confirmed late Roman activity. The cropmark Roman enclosures investigated by Trenches 101 and 103 continue south of the road, and the western arm of the larger enclosure was also confirmed as Roman by trenching there. On the west side of the site, it seems likely that the Iron Age enclosure ditch crossing Trench 77 also continued south of the road, and was represented by a much broader cropmark, though this was not investigated by trenching there.
- 5.2.12 **Post-medieval.** Occupation of the site does not appear to have continued beyond the late Roman period. Any subsequent activity was limited to a small post-medieval pit found in Trench 74, and evidence for otherwise agricultural use of the land. This was indicated by the traces of plough furrows in Trenches 58 and 62 and post-medieval field boundaries that correlate with plots defined on 19th century historic mapping.

## 5.3 Evaluation objectives and results

- 5.3.1 This evaluation established the presence of archaeological remains and investigated their character by analysing artefacts and environmental evidence. The evaluation also ground-truthed the cropmark evidence as identified by the 2019 aerial survey (Place Services 2019). The evaluation also investigated the apparently blank areas where no cropmarks had been identified.
- 5.3.2 The archaeological evaluation conducted the investigation within the general research parameters and objectives defined by the revised East of England Research Framework (Medlycott 2011), and to take account of the aims and objectives of the Greater Thames Estuary Historic Environment Research Framework.
- 5.3.3 In terms of specific objectives, the evaluation did find archaeological features in the central and northern parts of the site that were not visible as cropmarks, though these were relatively few. This was not, however, due to their being obscured by colluvium, which was not found in the trenches, but to the different underlying clay geology. Some of the archaeological features were also backfilled with material very similar to the surrounding natural geologies, meaning that they were unlikely to show as cropmarks. In the southern part of the site, where the geology was gravel, the correspondence between cropmarks and archaeological features was good, although (as is usual) small pits, small gullies and postholes were not evident as cropmarks.
- 5.3.4 The evaluation did not find any evidence of burial monuments of Neolithic or early Bronze Age date within the site, although a flint knife of this date may indicate that burials or ritual pits do exist elsewhere within the site. Only a single sherd that could date to the late Bronze Age, although it is possible that this sherd was early or middle Iron Age. No later Bronze Age activity was therefore confirmed within the site.
- 5.3.5 Occupation of the site began in the middle Iron Age, and continued thereafter through the late Iron Age and much of the Roman period. Although not directly dated, one of the penannular gullies was cut by a late Iron Age ditch, and another by an enclosure ditch containing middle Iron Age pottery. Some of the penannular gullies contained fired clay, suggesting that they were associated with structures, and they are believed to represent the gullies around roundhouses of Iron Age date.
- 5.3.6 The rectilinear enclosures begin in the middle Iron Age and continue into the Roman period, with the majority of the pottery coming from enclosures of middle Roman date.
- 5.3.7 No features or finds of Saxon or medieval date were found by the evaluation, and there was no evidence of medieval or post-medieval droeways.
- 5.3.8 Post-medieval field boundaries corresponding to those shown on historic maps were found in the north, central and south-eastern parts of the site. Post-medieval tile was found in those to the north, but closer dating was not possible. The boundary on the south-east contained an iron sickle bar

mower tooth of later 19th or early 20th century date. None of these features provided any evidence suggesting medieval origins.

5.3.9 No evidence of post-medieval farmsteads was identified within the site.

## Appendix A Trench Tables

| <b>Trench 1</b>  |       |         |           |           |   |                |      |
|--|-------|---------|-----------|-----------|---|----------------|------|
| General description  |       |         |           |           |   | Orientation    | E-W  |
| Trench revealed natural feature. Consists of ploughsoil and subsoil overlying natural geology of clayey silt |       |         |           |           |   | Length (m)     | 30   |
|  |       |         |           |           |   | Width (m)      | 2    |
|  |       |         |           |           |   | Avg. depth (m) | 0.38 |
| Context No.  | Type  | Fill Of | Width (m) | Depth (m) | Description   | Finds          | Date |
| 100  | Layer |         |           | 0.26      | Ploughsoil. Dark grey brown silty clay                                    |                |      |
| 101  | Layer |         |           | 0.12      | Subsoil. Mid orange brown silty clay                                      |                |      |
| 102  | Layer |         |           |           | Natural. Mid orange brown silty clay with patches of red brown silty clay |                |      |
| 103  | Cut   |         | 0.94      | 0.4       | Natural Feature   |                |      |
| 104  | Fill  | 103     | 0.85      | 0.3       | Secondary Fill. Light white grey, clayey/sandy silt                       |                |      |
| 105  | Fill  | 103     | 0.94      | 0.18      | Secondary Fill. Dark grey black, sandy silt                               |                |      |
| <b>Trench 5</b>  |       |         |           |           |   |                |      |
| General description  |       |         |           |           |   | Orientation    | N-S  |
| Trench revealed one terminus. Consists of ploughsoil and subsoil overlying natural geology of silty clay.    |       |         |           |           |   | Length (m)     | 30   |
|  |       |         |           |           |   | Width (m)      | 2    |
|  |       |         |           |           |   | Avg. depth (m) | 0.44 |
| Context No.  | Type  | Fill Of | Width (m) | Depth (m) | Description   | Finds          | Date |
| 500  | Layer |         |           | 0.31      | Ploughsoil. Dark grey brown silty clay                                    |                |      |
| 501  | Layer |         |           |           | Natural. Mid orange brown silty clay with gravels                         |                |      |
| 502  | Cut   |         | 0.74      | 0.48      | Ditch   |                |      |
| 503  | Fill  | 502     | 0.74      | 0.48      | Secondary Fill. Mid brownish grey, silty clay                             |                |      |
| <b>Trench 6</b>  |       |         |           |           |   |                |      |
| General description  |       |         |           |           |   | Orientation    | N-S  |
| Trench revealed one ditch. Consists of ploughsoil overlying natural geology of sandy clay.                   |       |         |           |           |   | Length (m)     | 30   |
|  |       |         |           |           |   | Width (m)      | 2    |
|  |       |         |           |           |   | Avg. depth (m) | 0.4  |
| Context No.  | Type  | Fill Of | Width (m) | Depth (m) | Description   | Finds          | Date |
| 600  | Layer |         | 2         | 0.3       | Ploughsoil. Dark grey brown sandy clay.                                   |                |      |
| 601  | Layer |         | 2         |           | Natural. Mid brownly orange sandy clay.                                   |                |      |
| 602  | Cut   |         | 0.85      | 0.68      | Ditch   |                |      |
| 603  | Fill  | 602     | 0.85      | 0.68      | Deliberate Backfill. Mixed orange clay and greyish purple silty clay.     |                |      |

| <b>Trench 7</b>   |       |         |           |           |  |                |       |
|---|-------|---------|-----------|-----------|--|----------------|-------|
| General description   |       |         |           |           |  | Orientation    | NE-SW |
| Trench revealed a single ditch. Consists of ploughsoil overlying natural geology of clay.     |       |         |           |           |  | Length (m)     | 30    |
|   |       |         |           |           |  | Width (m)      | 2     |
|   |       |         |           |           |  | Avg. depth (m) | 0.43  |
| Context No.   | Type  | Fill Of | Width (m) | Depth (m) | Description                                  | Finds          | Date  |
| 700   | Layer |         |           | 0.32      | Ploughsoil. Dark grey brown silty clay       |                |       |
| 701   | Layer |         |           |           | Natural. Mid orange brown silty clay         |                |       |
| 702   | Cut   |         | 1.02      | 0.5       | Ditch  |                |       |
| 703   | Fill  | 702     | 0.14      | 0.2       | Primary Fill. Light orangey brown silty clay |                |       |
| 704   | Fill  | 702     | 0.26      | 0.28      | Secondary Fill. Dark grey brown sandy clay.  |                |       |
| 705   | Fill  | 702     | 0.44      | 0.2       | Secondary Fill. Mid orangey brown silty clay |                |       |
| 706   | Fill  | 702     | 0.88      | 0.09      | Tertiary Fill. Dark grey brown sandy clay.   |                |       |
| <b>Trench 9</b>   |       |         |           |           |  |                |       |
| General description   |       |         |           |           |  | Orientation    | NE-SW |
| Trench devoid of archaeology. Consists of ploughsoil overlying natural geology of silty clay. |       |         |           |           |  | Length (m)     | 30    |
|   |       |         |           |           |  | Width (m)      | 2     |
|   |       |         |           |           |  | Avg. depth (m) | 0.34  |
| Context No.   | Type  | Fill Of | Width (m) | Depth (m) | Description                                  | Finds          | Date  |
| 900   | Layer |         |           | 0.27      | Ploughsoil. Dark grey brown silty clay       |                |       |
| 901   | Layer |         |           |           | Natural. Mid orange grey silty clay          |                |       |
| <b>Trench 14</b>  |       |         |           |           |  |                |       |
| General description   |       |         |           |           |  | Orientation    | N-S   |
| Trench devoid of archaeology. Consists of ploughsoil overlying natural geology of silty clay. |       |         |           |           |  | Length (m)     | 30    |
|   |       |         |           |           |  | Width (m)      | 2     |
|   |       |         |           |           |  | Avg. depth (m) | 0.38  |
| Context No.   | Type  | Fill Of | Width (m) | Depth (m) | Description                                  | Finds          | Date  |
| 1400  | Layer |         |           | 0.27      | Ploughsoil. Dark greyish brown, silty clay   |                |       |
| 1401  | Layer |         |           |           | Natural. Mid orangish brown, silty clay      |                |       |
| <b>Trench 15</b>  |       |         |           |           |  |                |       |
| General description   |       |         |           |           |  | Orientation    | N-S   |
| Trench revealed a single ditch. Consists of ploughsoil overlying natural geology of clay      |       |         |           |           |  | Length (m)     | 30    |
|   |       |         |           |           |  | Width (m)      | 2     |
|   |       |         |           |           |  | Avg. depth (m) | 0.4   |
| Context No.   | Type  | Fill Of | Width (m) | Depth (m) | Description                                  | Finds          | Date  |

|   |                     |         |           |           |  |                |       |
|---|---------------------|---------|-----------|-----------|--|----------------|-------|
| 1500  | Layer               |         |           | 0.31      | Ploughsoil. Dark grey brown silty clay   |                |       |
| 1501  | Layer               |         |           |           | Natural. Mid orange grey silty clay  |                |       |
| 1502  | Cut                 |         | 1.18      | 0.34      | Ditch  |                |       |
| 1503  | Fill                | 1502    |           | 0.34      | Grey clay, with rare charcoal flecks and small sub rounded imported stone inclusions |                |       |
| <b>Trench 16</b>  |                     |         |           |           |  |                |       |
| General description   |                     |         |           |           |  | Orientation    | E-W   |
| Trench devoid of archaeology. Consists of ploughsoil overlying natural geology of silty clay. |                     |         |           |           |  | Length (m)     | 30    |
|   |                     |         |           |           |  | Width (m)      | 2     |
|   |                     |         |           |           |  | Avg. depth (m) | 0.41  |
| Context No.   | Type                | Fill Of | Width (m) | Depth (m) | Description  | Finds          | Date  |
| 1600  | Layer               |         |           | 0.27      | Ploughsoil. Dark grey brown silty clay   |                |       |
| 1601  | Layer               |         |           |           | Natural. Mid orange grey silty clay  |                |       |
| <b>Trench 17</b>  |                     |         |           |           |  |                |       |
| General description   |                     |         |           |           |  | Orientation    | N-S   |
| Trench revealed two ditches. Consists of ploughsoil overlying natural geology of silty clay.  |                     |         |           |           |  | Length (m)     | 30    |
|   |                     |         |           |           |  | Width (m)      | 2     |
|   |                     |         |           |           |  | Avg. depth (m) | 0.38  |
| Context No.   | Type                | Fill Of | Width (m) | Depth (m) | Description  | Finds          | Date  |
| 1700  | Layer               |         |           | 0.3       | Ploughsoil. Dark grey brown silty clay   |                |       |
| 1701  | Layer               |         |           |           | Natural. Mid orange grey silty clay  |                |       |
| 1702  | Cut                 |         | 0.88      | 0.44      | Ditch  |                |       |
| 1703  | Fill                | 1702    | 0.88      | 0.44      | Deliberate Backfill. Compact, mid brownish grey silty clay.                          |                |       |
| 1704  | Unexcavated feature |         | 0.7       |           | Ditch  |                |       |
| <b>Trench 18</b>  |                     |         |           |           |  |                |       |
| General description   |                     |         |           |           |  | Orientation    | NE-SW |
| Trench devoid of archaeology. Consists of ploughsoil overlying natural geology of silty clay  |                     |         |           |           |  | Length (m)     | 30    |
|   |                     |         |           |           |  | Width (m)      | 2     |
|   |                     |         |           |           |  | Avg. depth (m) | 0.28  |
| Context No.   | Type                | Fill Of | Width (m) | Depth (m) | Description  | Finds          | Date  |
| 1800  | Layer               |         |           | 0.28      | Ploughsoil. Dark greyish brown, silty clay   |                |       |
| 1801  | Layer               |         |           |           | Natural. Mid orangish brown, silty clay  |                |       |
| <b>Trench 20</b>  |                     |         |           |           |  |                |       |
| General description   |                     |         |           |           |  | Orientation    | E-W   |
|   |                     |         |           |           |  | Length (m)     | 30    |



| Trench devoid of archaeology. Consists of ploughsoil overlying natural geology of silty clay. |       |         |           |           |  | Width (m)      | 2    |
|---|-------|---------|-----------|-----------|--|----------------|------|
|   |       |         |           |           |  | Avg. depth (m) | 0.44 |
| Context No.   | Type  | Fill Of | Width (m) | Depth (m) | Description                            | Finds          | Date |
| 2000  | Layer |         |           | 0.33      | Ploughsoil. Dark grey brown silty clay |                |      |
| 2001  | Layer |         |           |           | Natural. Mid orange brown silty clay   |                |      |

### Trench 21

| General description   |       |         |           |           |   | Orientation          | N-S    |
|---|-------|---------|-----------|-----------|---|----------------------|--------|
| Trench revealed three ditches. Consists of ploughsoil overlying natural geology of silty clay and gravel. |       |         |           |           |   | Length (m)           | 30     |
|   |       |         |           |           |   | Width (m)            | 2      |
|   |       |         |           |           |   | Avg. depth (m)       | 0.33   |
| Context No.   | Type  | Fill Of | Width (m) | Depth (m) | Description   | Finds                | Date   |
| 2100  | Layer |         |           | 0.38      | Ploughsoil. Dark greyish brown, silty clay  |                      |        |
| 2101  | Layer |         |           |           | Natural. Mid orangish brown, silty clay   |                      |        |
| 2102  | Cut   |         | 0.6       | 0.5       | Ditch   |                      |        |
| 2103  | Fill  | 2102    | 0.6       | 0.5       | Deliberate Backfill. Mixed, patchy, orange, mid-grey, soft, silty clay.                                 | Pot                  | 40-410 |
| 2104  | Cut   |         | 0.66      | 0.54      | Ditch   |                      |        |
| 2105  | Fill  | 2104    | 0.36      | 0.08      | Primary Fill. Orange-yellow, soft silty clay.   |                      |        |
| 2106  | Fill  | 2104    | 0.5       | 0.26      | Deliberate Backfill. Mixed, patchy, blueish grey and orange-brown soft silty clay with charcoal flecks. | Sample <14>          |        |
| 2107  | Fill  | 2104    | 0.66      | 0.28      | Deliberate Backfill. Mid-grey, soft, silty, sandy clay with manganese. Contained finds.                 | Pot, FC, Sample <15> | 40-410 |
| 2108  | Cut   |         | 0.68      | 0.52      | Ditch   |                      |        |
| 2109  | Fill  | 2108    | 0.52      | 0.08      | Deliberate Backfill. Mixed, patchy, mid-grey and orange-brown, soft, silty, sandy clay.                 |                      |        |
| 2110  | Fill  | 2108    | 0.58      | 0.18      | Deliberate Backfill. Brown-orange, soft, silty clay.  |                      |        |
| 2111  | Fill  | 2108    | 0.68      | 0.18      | Deliberate Backfill. Mid-grey, orange patchy, soft, silt, sandy clay.                                   | Pot                  | 40-410 |

### Trench 22

| General description   |       |         |           |           |  | Orientation    | E-W  |
|---|-------|---------|-----------|-----------|--|----------------|------|
| Trench revealed one ditch. Consists of ploughsoil overlying natural geology of silty clay |       |         |           |           |  | Length (m)     | 30   |
|   |       |         |           |           |  | Width (m)      | 2    |
|   |       |         |           |           |  | Avg. depth (m) | 0.4  |
| Context No.   | Type  | Fill Of | Width (m) | Depth (m) | Description                                | Finds          | Date |
| 2200  | Layer |         |           | 0.4       | Ploughsoil. Dark greyish brown, silty clay |                |      |
| 2201  | Layer |         |           |           | Natural. Mid orangish brown, silty clay    |                |      |
| 2202  | Cut   |         | 0.75      | 0.26      | Ditch                                      |                |      |

|   |                     |         |           |           |  |                |          |
|---|---------------------|---------|-----------|-----------|--|----------------|----------|
| 2203  | Fill                | 2202    |           | 0.26      | Tertiary Fill. Mid brown grey clay silt with occasional sub-rounded and rounded stones | Tile           | Med-Pmed |
| <b>Trench 23</b>  |                     |         |           |           |  |                |          |
| General description   |                     |         |           |           |  | Orientation    | N-S      |
| Trench revealed two furrows. Consists of ploughsoil overlying natural geology of silty clay   |                     |         |           |           |  | Length (m)     | 30       |
|   |                     |         |           |           |  | Width (m)      | 2        |
|   |                     |         |           |           |  | Avg. depth (m) | 0.31     |
| Context No.   | Type                | Fill Of | Width (m) | Depth (m) | Description  | Finds          | Date     |
| 2300  | Layer               |         |           | 0.31      | Ploughsoil. Dark greyish brown, silty clay   |                |          |
| 2301  | Layer               |         |           |           | Natural. Mid orangish brown, silty clay  |                |          |
| 2302  | Cut                 |         | 0.7       | 0.34      | Ditch  |                |          |
| 2303  | Fill                | 2302    | 0.7       | 0.16      | Deliberate Backfill. Firm, mid brownish grey silty clay.                               |                |          |
| 2304  | Unexcavated feature |         | 0.75      |           | Ditch. Compact, light greyish brown silty clay.  |                |          |
| 2305  | Fill                | 2302    | 0.64      | 0.22      | Deliberate Backfill. Compact, light greyish brown silty clay.                          |                |          |
| <b>Trench 24</b>  |                     |         |           |           |  |                |          |
| General description   |                     |         |           |           |  | Orientation    | E-W      |
| Trench devoid of archaeology. Consists of ploughsoil overlying natural geology of silty clay. |                     |         |           |           |  | Length (m)     | 30       |
|   |                     |         |           |           |  | Width (m)      | 2        |
|   |                     |         |           |           |  | Avg. depth (m) | 0.44     |
| Context No.   | Type                | Fill Of | Width (m) | Depth (m) | Description  | Finds          | Date     |
| 2400  | Layer               |         |           | 0.35      | Ploughsoil. Dark grey brown silty clay   |                |          |
| 2401  | Layer               |         |           |           | Natural. Mid orange grey silty clay  |                |          |
| <b>Trench 25</b>  |                     |         |           |           |  |                |          |
| General description   |                     |         |           |           |  | Orientation    | N-S      |
| Trench devoid of archaeology. Consists of ploughsoil overlying natural geology of silty clay. |                     |         |           |           |  | Length (m)     | 30       |
|   |                     |         |           |           |  | Width (m)      | 2        |
|   |                     |         |           |           |  | Avg. depth (m) | 0.41     |
| Context No.   | Type                | Fill Of | Width (m) | Depth (m) | Description  | Finds          | Date     |
| 2500  | Layer               |         |           | 0.33      | Ploughsoil. Dark grey brown silty clay   |                |          |
| 2501  | Layer               |         |           |           | Natural. Mid orange grey silty clay with occasional gravels                            |                |          |
| <b>Trench 26</b>  |                     |         |           |           |  |                |          |
| General description   |                     |         |           |           |  | Orientation    | E-W      |
| Trench devoid of archaeology. Consists of ploughsoil overlying natural geology of silty clay. |                     |         |           |           |  | Length (m)     | 30       |
|   |                     |         |           |           |  | Width (m)      |          |
|   |                     |         |           |           |  | Avg. depth (m) | 0.43     |

| Context No.  | Type  | Fill Of | Width (m) | Depth (m) | Description  | Finds          | Date   |
|--|-------|---------|-----------|-----------|--|----------------|--------|
| 2600   | Layer |         |           | 0.32      | Ploughsoil. Dark greyish brown, silty clay                                   |                |        |
| 2601   | Layer |         |           |           | Natural. Mid orangish brown, silty clay                                      |                |        |
| <b>Trench 27</b>   |       |         |           |           |  |                |        |
| General description  |       |         |           |           |  | Orientation    | E-W    |
| Trench revealed one ditch. Consists of ploughsoil and subsoil overlying natural geology of silty clay  |       |         |           |           |  | Length (m)     | 30     |
|  |       |         |           |           |  | Width (m)      | 2      |
|  |       |         |           |           |  | Avg. depth (m) | 0.5    |
| Context No.  | Type  | Fill Of | Width (m) | Depth (m) | Description  | Finds          | Date   |
| 2700   | Layer |         | 2         | 0.3       | Ploughsoil. Mid grey brown sandy clay  |                |        |
| 2701   | Layer |         | 2         | 0.1       | Subsoil. Mid orangey brown sandy clay  |                |        |
| 2702   | Layer |         | 2         |           | Natural. Light brown orange sandy clay                                       |                |        |
| 2703   | Cut   |         | 0.98      | 0.42      | Ditch  |                |        |
| 2704   | Fill  | 2703    | 0.98      | 0.42      | Secondary Fill. Light brownish grey, silty clay                              |                |        |
| 2705   | Layer |         | 0.95      |           | Natural. Tested. Not recorded. Soft, mid brown mottled dark brown silty sand |                |        |
| <b>Trench 28</b>   |       |         |           |           |  |                |        |
| General description  |       |         |           |           |  | Orientation    | N-S    |
| Trench revealed one ditch. Consists of ploughsoil and subsoil overlying natural geology of clayey silt |       |         |           |           |  | Length (m)     | 30     |
|  |       |         |           |           |  | Width (m)      | 2      |
|  |       |         |           |           |  | Avg. depth (m) | 0.4    |
| Context No.  | Type  | Fill Of | Width (m) | Depth (m) | Description  | Finds          | Date   |
| 2800   | Layer |         | 2         | 0.25      | Ploughsoil. Mid grey brown sandy clay.                                       |                |        |
| 2801   | Layer |         | 2         | 0.1       | Subsoil. Mid orangey brown sandy clay  |                |        |
| 2802   | Layer |         | 2         |           | Natural. Light orangey brown clayey silt                                     |                |        |
| 2803   | Cut   |         | 0.54      | 0.45      | Ditch. Recorded as a gully   |                |        |
| 2804   | Fill  | 2803    | 0.54      | 0.45      | Secondary Fill. Orangey mottled light brown grey, clayey silt                | Pot            | 40-410 |
| <b>Trench 29</b>   |       |         |           |           |  |                |        |
| General description  |       |         |           |           |  | Orientation    | E-W    |
| Trench revealed two tree throws. Consists of ploughsoil overlying natural geology of clay.             |       |         |           |           |  | Length (m)     | 30     |
|  |       |         |           |           |  | Width (m)      | 2      |
|  |       |         |           |           |  | Avg. depth (m) | 0.27   |
| Context No.  | Type  | Fill Of | Width (m) | Depth (m) | Description  | Finds          | Date   |
| 2900   | Layer |         | 30        | 0.3       | Ploughsoil. Dark greyish brown silty clay.                                   |                |        |
| 2901   | Layer |         | 30        |           | Natural. Light brown clay.   |                |        |

|   |       |         |           |           |   |                |      |
|---|-------|---------|-----------|-----------|---|----------------|------|
| 2902  | Cut   |         | 1.1       | 0.2       | Tree Throw  |                |      |
| 2903  | Fill  | 2902    | 1.1       | 0.2       | Secondary Fill. Firm, mid brown silty clay.                   |                |      |
| <b>Trench 30</b>  |       |         |           |           |   |                |      |
| General description   |       |         |           |           |   | Orientation    | N-S  |
| Trench devoid of archaeology. Consists of ploughsoil overlying natural geology of silty clay. |       |         |           |           |   | Length (m)     | 30   |
|   |       |         |           |           |   | Width (m)      | 2    |
|   |       |         |           |           |   | Avg. depth (m) | 0.5  |
| Context No.   | Type  | Fill Of | Width (m) | Depth (m) | Description   | Finds          | Date |
| 3000  | Layer |         |           | 0.25      | Ploughsoil. Dark grey brown silty clay                        |                |      |
| 3001  | Layer |         |           |           | Natural. Light orange grey silty clay with occasional gravels |                |      |
| <b>Trench 31</b>  |       |         |           |           |   |                |      |
| General description   |       |         |           |           |   | Orientation    | E-W  |
| Trench devoid of archaeology. Consists of ploughsoil overlying natural geology of silty clay. |       |         |           |           |   | Length (m)     | 30   |
|   |       |         |           |           |   | Width (m)      | 2    |
|   |       |         |           |           |   | Avg. depth (m) | 0.46 |
| Context No.   | Type  | Fill Of | Width (m) | Depth (m) | Description   | Finds          | Date |
| 3100  | Layer |         |           | 0.31      | Ploughsoil. Dark grey brown silty clay                        |                |      |
| 3101  | Layer |         |           |           | Natural. Mid orange grey silty clay with occasional gravels   |                |      |
| <b>Trench 32</b>  |       |         |           |           |   |                |      |
| General description   |       |         |           |           |   | Orientation    | N-S  |
| Trench devoid of archaeology. Consists of ploughsoil overlying natural geology of silty clay. |       |         |           |           |   | Length (m)     | 30   |
|   |       |         |           |           |   | Width (m)      | 2    |
|   |       |         |           |           |   | Avg. depth (m) | 0.37 |
| Context No.   | Type  | Fill Of | Width (m) | Depth (m) | Description   | Finds          | Date |
| 3200  | Layer |         |           | 0.27      | Ploughsoil. Dark grey brown silty clay.                       |                |      |
| 3201  | Layer |         |           |           | Natural. Mid orange grey silty clay with occasional gravels.  |                |      |
| <b>Trench 33</b>  |       |         |           |           |   |                |      |
| General description   |       |         |           |           |   | Orientation    | E-W  |
| Trench revealed one ditch. Consists of ploughsoil overlying natural geology of silty clay.    |       |         |           |           |   | Length (m)     | 30   |
|   |       |         |           |           |   | Width (m)      | 2    |
|   |       |         |           |           |   | Avg. depth (m) | 0.45 |
| Context No.   | Type  | Fill Of | Width (m) | Depth (m) | Description   | Finds          | Date |
| 3300  | Layer |         |           | 0.45      | Ploughsoil. Dark greyish brown, silty clay.                   |                |      |
| 3301  | Layer |         |           |           | Natural. Mid yellowish brown, silty clay.                     |                |      |

|  |                     |         |           |           |   |                |      |
|--|---------------------|---------|-----------|-----------|---|----------------|------|
| 3302   | Unexcavated feature |         | 0.81      |           | Ditch. Dark grey brown, silty clay. Unexcavated post-medieval field boundary ditch. |                |      |
| <b>Trench 34</b>   |                     |         |           |           |   |                |      |
| General description  |                     |         |           |           |   | Orientation    | N-S  |
| Trench devoid of archaeology. Consists of ploughsoil overlying natural geology of silty clay.  |                     |         |           |           |   | Length (m)     | 30   |
|  |                     |         |           |           |   | Width (m)      | 2    |
|  |                     |         |           |           |   | Avg. depth (m) | 0.42 |
| Context No.  | Type                | Fill Of | Width (m) | Depth (m) | Description   | Finds          | Date |
| 3400   | Layer               |         |           | 0.42      | Ploughsoil. Dark greyish brown, silty clay  |                |      |
| 3401   | Layer               |         |           |           | Natural. Mid orangish brown, silty clay   |                |      |
| <b>Trench 35</b>   |                     |         |           |           |   |                |      |
| General description  |                     |         |           |           |   | Orientation    | E-W  |
| Trench devoid of archaeology. Consists of ploughsoil overlying natural geology of silty clay.  |                     |         |           |           |   | Length (m)     | 30   |
|  |                     |         |           |           |   | Width (m)      | 2    |
|  |                     |         |           |           |   | Avg. depth (m) | 0.25 |
| Context No.  | Type                | Fill Of | Width (m) | Depth (m) | Description   | Finds          | Date |
| 3500   | Layer               |         |           | 0.25      | Ploughsoil. Dark greyish brown, silty clay  |                |      |
| 3501   | Layer               |         |           |           | Natural. Mid orangish brown, silty clay   |                |      |
| <b>Trench 36</b>   |                     |         |           |           |   |                |      |
| General description  |                     |         |           |           |   | Orientation    | N-S  |
| Trench devoid of archaeology. Consists of ploughsoil overlying natural geology of clayey silt. |                     |         |           |           |   | Length (m)     | 30   |
|  |                     |         |           |           |   | Width (m)      | 2    |
|  |                     |         |           |           |   | Avg. depth (m) | 0.29 |
| Context No.  | Type                | Fill Of | Width (m) | Depth (m) | Description   | Finds          | Date |
| 3600   | Layer               |         |           | 0.29      | Ploughsoil. Dark grey brown, clayey silt  |                |      |
| 3601   | Layer               |         |           |           | Natural. Mid yellow brown, clayey silt  |                |      |
| <b>Trench 37</b>   |                     |         |           |           |   |                |      |
| General description  |                     |         |           |           |   | Orientation    | E-W  |
| Trench revealed tree throw. Consists of ploughsoil overlying natural geology of clayey silt.   |                     |         |           |           |   | Length (m)     | 30   |
|  |                     |         |           |           |   | Width (m)      | 2    |
|  |                     |         |           |           |   | Avg. depth (m) | 0.3  |
| Context No.  | Type                | Fill Of | Width (m) | Depth (m) | Description   | Finds          | Date |
| 3700   | Layer               |         |           | 0.3       | Ploughsoil. Dark grey brown, clayey silt  |                |      |
| 3701   | Layer               |         |           |           | Natural. Mid yellow brown, clayey silt  |                |      |
| 3702   | Cut                 |         | 1.07      | 0.3       | Tree Throw  |                |      |

|  |       |         |           |           |   |                |      |
|--|-------|---------|-----------|-----------|---|----------------|------|
| 3703   | Fill  | 3702    |           | 0.24      | Other Fill. Mid yellow brown clay silt. Area of pale grey possible "leeching" at base of fill |                |      |
| 3704   | Fill  | 3702    |           | 0.22      | Other Fill. Mid brown grey clay silt with evidence of bioturbation and root activity          |                |      |
| <b>Trench 38</b>   |       |         |           |           |   |                |      |
| General description  |       |         |           |           |   | Orientation    | N-S  |
| Trench revealed on ditch. Consists of ploughsoil overlying natural geology of clayey silt and occasional gravels.      |       |         |           |           |   | Length (m)     | 30   |
|  |       |         |           |           |   | Width (m)      | 2    |
|  |       |         |           |           |   | Avg. depth (m) | 0.3  |
| Context No.  | Type  | Fill Of | Width (m) | Depth (m) | Description   | Finds          | Date |
| 3800   | Layer |         |           | 0.3       | Ploughsoil. Dark grey brown, clayey silt  | Flint          |      |
| 3801   | Layer |         |           |           | Natural. Mid yellow brown, clayey silt with occasional gravels                                |                |      |
| 3802   | Cut   |         | 0.94      | 0.4       | Ditch   |                |      |
| 3803   | Fill  | 3802    | 0.36      | 0.1       | Deliberate Backfill. Firm, dark brownish grey silty clay.                                     |                |      |
| 3804   | Fill  | 3802    | 0.94      | 0.3       | Deliberate Backfill. Compact, dark brownish grey silty clay.                                  |                |      |
| <b>Trench 39</b>   |       |         |           |           |   |                |      |
| General description  |       |         |           |           |   | Orientation    | E-W  |
| Trench devoid of archaeology. Consists of ploughsoil overlying natural geology of clayey silt.                         |       |         |           |           |   | Length (m)     | 30   |
|  |       |         |           |           |   | Width (m)      | 2    |
|  |       |         |           |           |   | Avg. depth (m) | 0.28 |
| Context No.  | Type  | Fill Of | Width (m) | Depth (m) | Description   | Finds          | Date |
| 3900   | Layer |         |           | 0.28      | Ploughsoil. Dark grey brown, clayey silt  |                |      |
| 3901   | Layer |         |           |           | Natural. Light yellow brown, clayey silt  |                |      |
| <b>Trench 40</b>   |       |         |           |           |   |                |      |
| General description  |       |         |           |           |   | Orientation    | N-S  |
| Trench devoid of archaeology. Consists of ploughsoil overlying natural geology of clayey silt.                         |       |         |           |           |   | Length (m)     | 30   |
|  |       |         |           |           |   | Width (m)      | 2    |
|  |       |         |           |           |   | Avg. depth (m) | 0.3  |
| Context No.  | Type  | Fill Of | Width (m) | Depth (m) | Description   | Finds          | Date |
| 4000   | Layer |         |           | 0.3       | Ploughsoil. Dark grey brown, clayey silt  |                |      |
| 4001   | Layer |         |           |           | Natural. Light yellow brown, clayey silt  |                |      |
| <b>Trench 41</b>   |       |         |           |           |   |                |      |
| General description  |       |         |           |           |   | Orientation    | E-W  |
| Trench revealed two furrows and one ditch. Consists of ploughsoil and subsoil overlying natural geology of silty clay. |       |         |           |           |   | Length (m)     | 30   |
|  |       |         |           |           |   | Width (m)      | 2    |

|  |       |         |           |           |   |                | Avg. depth (m) | 0.39 |
|--|-------|---------|-----------|-----------|---|----------------|----------------|------|
| Context No.  | Type  | Fill Of | Width (m) | Depth (m) | Description   | Finds          | Date           |      |
| 4100   | Layer |         |           | 0.24      | Ploughsoil. Mid grey clay silt  |                |                |      |
| 4101   | Layer |         |           | 0.26      | Subsoil. Mid grey brown silt clay   |                |                |      |
| 4102   | Layer |         |           |           | Natural. Mid yellow brown silt clay   |                |                |      |
| 4103   | Cut   |         | 1.22      | 0.52      | Ditch   |                |                |      |
| 4104   | Fill  | 4103    | 1.22      | 0.52      | Secondary Fill. Mid brownish grey, silty clay                                       |                |                |      |
| 4105   | Cut   |         | 1.82      | 0.21      | Plough Furrow   |                |                |      |
| 4106   | Fill  | 4105    | 1.82      | 0.21      | Primary Fill. Mid orange brown silty clay   |                |                |      |
| 4107   | Cut   |         | 1.5       | 0.25      | Plough Furrow   |                |                |      |
| 4108   | Fill  | 4107    | 1.5       | 0.24      | Secondary Fill. Light greyish brown, clayey silt                                    | Pot, FC        | 40-410         |      |
| <b>Trench 42</b>   |       |         |           |           |   |                |                |      |
| General description  |       |         |           |           |   | Orientation    | E-W            |      |
| Trench devoid of archaeology. Consists of ploughsoil overlying natural geology of clay with gravel patches.            |       |         |           |           |   | Length (m)     | 30             |      |
|  |       |         |           |           |   | Width (m)      | 2              |      |
|  |       |         |           |           |   | Avg. depth (m) | 0.27           |      |
| Context No.  | Type  | Fill Of | Width (m) | Depth (m) | Description   | Finds          | Date           |      |
| 4200   | Layer |         |           | 0.26      | Topsoil. Mid grey brown, silt clay, friable with root and rounded stone inclusions  |                |                |      |
| 4201   | Layer |         |           | 0.01      | Natural. Mid orange brown, silty clay with gravel patches                           |                |                |      |
| <b>Trench 43</b>   |       |         |           |           |   |                |                |      |
| General description  |       |         |           |           |   | Orientation    | E-W            |      |
| Trench devoid of archaeology. Consists of ploughsoil overlying natural geology of clayey silt with occasional gravels. |       |         |           |           |   | Length (m)     | 30             |      |
|  |       |         |           |           |   | Width (m)      | 2              |      |
|  |       |         |           |           |   | Avg. depth (m) | 0.28           |      |
| Context No.  | Type  | Fill Of | Width (m) | Depth (m) | Description   | Finds          | Date           |      |
| 4300   | Layer |         |           | 0.28      | Ploughsoil. Dark grey brown, clayey silt  |                |                |      |
| 4301   | Layer |         |           |           | Natural. Mid yellow/red brown, clayey silt with occasional gravels                  |                |                |      |
| <b>Trench 44</b>   |       |         |           |           |   |                |                |      |
| General description  |       |         |           |           |   | Orientation    | N-S            |      |
| Trench devoid of archaeology. Consists of ploughsoil overlying natural geology of silty clay.                          |       |         |           |           |   | Length (m)     | 30             |      |
|  |       |         |           |           |   | Width (m)      | 2              |      |
|  |       |         |           |           |   | Avg. depth (m) | 0.25           |      |
| Context No.  | Type  | Fill Of | Width (m) | Depth (m) | Description   | Finds          | Date           |      |
| 4400   | Layer |         |           | 0.28      | Topsoil. Mid grey brown, silt clay, friable, rooting with rounded stone inclusions. |                |                |      |

|   |       |         |           |           |   |                |      |
|---|-------|---------|-----------|-----------|---|----------------|------|
| 4401  | Layer |         |           | 0.3       | Natural. Mid orangey yellow brown, silt clay with gravel patches. Friable |                |      |
| <b>Trench 46</b>  |       |         |           |           |   |                |      |
| General description   |       |         |           |           |   | Orientation    | N-S  |
| Trench devoid of archaeology. Consists of ploughsoil and subsoil overlying natural geology of silty clay. |       |         |           |           |   | Length (m)     | 30   |
|   |       |         |           |           |   | Width (m)      | 2    |
|   |       |         |           |           |   | Avg. depth (m) | 0.5  |
| Context No.   | Type  | Fill Of | Width (m) | Depth (m) | Description   | Finds          | Date |
| 4600  | Layer |         |           | 0.26      | Ploughsoil. Mid grey clay silt  |                |      |
| 4601  | Layer |         |           | 0.34      | Subsoil. Mid grey brown silt clay   |                |      |
| 4602  | Layer |         |           |           | Natural. Mid yellow brown silt clay                                       |                |      |
| <b>Trench 47</b>  |       |         |           |           |   |                |      |
| General description   |       |         |           |           |   | Orientation    | E-W  |
| Trench devoid of archaeology. Consists of ploughsoil overlying natural geology of clayey silt             |       |         |           |           |   | Length (m)     | 30   |
|   |       |         |           |           |   | Width (m)      | 2    |
|   |       |         |           |           |   | Avg. depth (m) | 0.33 |
| Context No.   | Type  | Fill Of | Width (m) | Depth (m) | Description   | Finds          | Date |
| 4700  | Layer |         |           | 0.33      | Ploughsoil. Dark grey brown, clayey silt                                  |                |      |
| 4701  | Layer |         |           |           | Natural. Light yellow brown, clayey silt                                  |                |      |
| <b>Trench 49</b>  |       |         |           |           |   |                |      |
| General description   |       |         |           |           |   | Orientation    | N-S  |
| Trench devoid of archaeology. Consists of ploughsoil and subsoil overlying natural geology of silty clay  |       |         |           |           |   | Length (m)     | 30   |
|   |       |         |           |           |   | Width (m)      | 2    |
|   |       |         |           |           |   | Avg. depth (m) | 0.48 |
| Context No.   | Type  | Fill Of | Width (m) | Depth (m) | Description   | Finds          | Date |
| 4900  | Layer |         |           | 0.23      | Ploughsoil. Mid grey clay silt  |                |      |
| 4901  | Layer |         |           | 0.25      | Subsoil. Mid grey brown clay silt   |                |      |
| 4902  | Layer |         |           |           | Natural. Mid yellow brown silt clay                                       |                |      |
| <b>Trench 50</b>  |       |         |           |           |   |                |      |
| General description   |       |         |           |           |   | Orientation    | E-W  |
| Trench devoid of archaeology. Consists of ploughsoil overlying natural geology of silty clay.             |       |         |           |           |   | Length (m)     | 30   |
|   |       |         |           |           |   | Width (m)      | 2    |
|   |       |         |           |           |   | Avg. depth (m) | 0.48 |
| Context No.   | Type  | Fill Of | Width (m) | Depth (m) | Description   | Finds          | Date |
| 5000  | Layer |         |           | 0.34      | Ploughsoil. Dark grey brown silty clay                                    |                |      |



|   |       |         |           |           |  |                |      |
|---|-------|---------|-----------|-----------|--|----------------|------|
| 5001  | Layer |         |           |           | Natural. Mid orange brown silty clay             |                |      |
| <b>Trench 51</b>  |       |         |           |           |  |                |      |
| General description   |       |         |           |           |  | Orientation    | N-S  |
| Trench devoid of archaeology. Consists of ploughsoil overlying natural geology of sandy clay.             |       |         |           |           |  | Length (m)     | 30   |
|   |       |         |           |           |  | Width (m)      | 2    |
|   |       |         |           |           |  | Avg. depth (m) | 0.5  |
| Context No.   | Type  | Fill Of | Width (m) | Depth (m) | Description                                      | Finds          | Date |
| 5100  | Layer |         | 2         | 0.35      | Ploughsoil. Dark grey brown sandy clay.          |                |      |
| 5101  | Layer |         | 2         |           | Natural. Mid browny orange sandy clay.           |                |      |
| <b>Trench 52</b>  |       |         |           |           |  |                |      |
| General description   |       |         |           |           |  | Orientation    | E-W  |
| Trench devoid of archaeology. Consists of ploughsoil overlying natural geology of sandy clay.             |       |         |           |           |  | Length (m)     | 30   |
|   |       |         |           |           |  | Width (m)      | 2    |
|   |       |         |           |           |  | Avg. depth (m) | 0.4  |
| Context No.   | Type  | Fill Of | Width (m) | Depth (m) | Description                                      | Finds          | Date |
| 5200  | Layer |         |           |           | Natural. Mid browny orange sandy clay            |                |      |
| 5201  | Layer |         |           | 0.3       | Ploughsoil. Mid grey brown sandy clay.           |                |      |
| <b>Trench 53</b>  |       |         |           |           |  |                |      |
| General description   |       |         |           |           |  | Orientation    | N-S  |
| Trench devoid of archaeology. Consists of ploughsoil and subsoil overlying natural geology of silty clay  |       |         |           |           |  | Length (m)     | 30   |
|   |       |         |           |           |  | Width (m)      | 2    |
|   |       |         |           |           |  | Avg. depth (m) | 0.38 |
| Context No.   | Type  | Fill Of | Width (m) | Depth (m) | Description                                      | Finds          | Date |
| 5300  | Layer |         |           | 0.23      | Ploughsoil. Mid grey clay silt                   |                |      |
| 5301  | Layer |         |           | 0.15      | Subsoil. Mid grey brown silt clay                |                |      |
| 5302  | Layer |         |           |           | Natural. Mid yellow brown silt clay              |                |      |
| <b>Trench 54</b>  |       |         |           |           |  |                |      |
| General description   |       |         |           |           |  | Orientation    | E-W  |
| Trench devoid of archaeology. Consists of ploughsoil and subsoil overlying natural geology of silty clay. |       |         |           |           |  | Length (m)     | 30   |
|   |       |         |           |           |  | Width (m)      | 2    |
|   |       |         |           |           |  | Avg. depth (m) | 0.38 |
| Context No.   | Type  | Fill Of | Width (m) | Depth (m) | Description                                      | Finds          | Date |
| 5400  | Layer |         |           | 0.3       | Ploughsoil. Dark grey brown, clay silt           |                |      |
| 5401  | Layer |         |           | 0.08      | Subsoil. Mid orangey brown, clay silt.           |                |      |
| 5402  | Layer |         |           |           | Natural. Mixed light brown and grey, silty clay. |                |      |

| <b>Trench 55</b>  |       |         |           |           |   |                |         |
|---|-------|---------|-----------|-----------|---|----------------|---------|
| General description   |       |         |           |           |   | Orientation    | N-S     |
| Trench devoid of archaeology. Consists of ploughsoil overlying natural geology of sandy clay.       |       |         |           |           |   | Length (m)     | 30      |
|   |       |         |           |           |   | Width (m)      | 2       |
|   |       |         |           |           |   | Avg. depth (m) | 0.4     |
| Context No.   | Type  | Fill Of | Width (m) | Depth (m) | Description   | Finds          | Date    |
| 5500  | Layer |         |           | 0.25      | Ploughsoil. Mid grey brown sandy clay                       |                |         |
| 5501  | Layer |         |           |           | Natural. Mid brownly orange sandy clay.                     |                |         |
| <b>Trench 56</b>  |       |         |           |           |   |                |         |
| General description   |       |         |           |           |   | Orientation    | E-W     |
| Trench revealed one ditch. Consists of topsoil and subsoil overlying natural geology of silty clay. |       |         |           |           |   | Length (m)     | 30      |
|   |       |         |           |           |   | Width (m)      | 2       |
|   |       |         |           |           |   | Avg. depth (m) | 0.3     |
| Context No.   | Type  | Fill Of | Width (m) | Depth (m) | Description   | Finds          | Date    |
| 5600  | Layer |         | 2         | 0.3       | Ploughsoil. Dark greyish brown, firm silty clay.            |                |         |
| 5601  | Layer |         | 2         | 0.05      | Subsoil. Mid brown, firm silty clay.                        |                |         |
| 5602  | Layer |         | 2         |           | Natural. Light brown, compact clay/silty clay.              |                |         |
| 5603  | Cut   |         | 1.5       | 0.5       | Ditch. Modern boundary ditch.                               |                |         |
| 5604  | Fill  | 5603    | 1.5       | 0.5       | Deliberate Backfill. Compact, mid greyish brown silty clay. | Tile           | Pmed    |
| <b>Trench 57</b>  |       |         |           |           |   |                |         |
| General description   |       |         |           |           |   | Orientation    | NNW-SSE |
| Trench devoid of archaeology. Consists of ploughsoil and subsoil overlying natural geology of clay. |       |         |           |           |   | Length (m)     | 30      |
|   |       |         |           |           |   | Width (m)      | 2       |
|   |       |         |           |           |   | Avg. depth (m) | 0.55    |
| Context No.   | Type  | Fill Of | Width (m) | Depth (m) | Description   | Finds          | Date    |
| 5700  | Layer |         |           | 0.3       | Ploughsoil. Dark grey brown clayey silt                     |                |         |
| 5701  | Layer |         |           | 0.25      | Subsoil. Mid yellow clay                                    |                |         |
| 5702  | Layer |         |           |           | Natural. Mid yellow grey clay                               |                |         |
| <b>Trench 58</b>  |       |         |           |           |   |                |         |
| General description   |       |         |           |           |   | Orientation    | E-W     |
| Trench revealed one ditch. Consists of ploughsoil overlying natural geology of clay.                |       |         |           |           |   | Length (m)     | 30      |
|   |       |         |           |           |   | Width (m)      | 2       |
|   |       |         |           |           |   | Avg. depth (m) | 0.3     |
| Context No.   | Type  | Fill Of | Width (m) | Depth (m) | Description   | Finds          | Date    |

|      |       |      |     |      |  |  |  |
|------|-------|------|-----|------|--|--|--|
| 5800 | Layer |      |     | 0.3  | Ploughsoil. Mid grey brown, silt clay, friable with rooting and rounded stone inclusions |  |  |
| 5801 | Layer |      |     | 0.2  | Natural. Mid orangey yellow brown, clay with gravel patches.                             |  |  |
| 5802 | Cut   |      | 1.4 | 0.16 | Plough Furrow  |  |  |
| 5803 | Fill  | 5802 |     |      | Primary Fill. Orangey Brown clay compact   |  |  |

#### Trench 59

| General description   |       |         |           |           |  | Orientation    | N-S  |
|---|-------|---------|-----------|-----------|--|----------------|------|
| Trench devoid of archaeology. Consists of ploughsoil overlying natural geology of clay. |       |         |           |           |  | Length (m)     | 30   |
|   |       |         |           |           |  | Width (m)      | 2    |
|   |       |         |           |           |  | Avg. depth (m) | 0.3  |
| Context No.   | Type  | Fill Of | Width (m) | Depth (m) | Description  | Finds          | Date |
| 5900  | Layer |         | 2         | 0.28      | Topsoil. Mid grey brown, silt sand, with rooting and rounded stone inclusions. Loose |                |      |
| 5901  | Layer |         |           | 0.02      | Natural. Mid orangey yellowish brown, gravelly sand with clay patches, firm          |                |      |

#### Trench 60

| General description   |       |         |           |           |  | Orientation    | E-W  |
|---|-------|---------|-----------|-----------|--|----------------|------|
| Trench devoid of archaeology. Consists of ploughsoil overlying natural geology of clay. |       |         |           |           |  | Length (m)     | 30   |
|   |       |         |           |           |  | Width (m)      | 2    |
|   |       |         |           |           |  | Avg. depth (m) | 0.4  |
| Context No.   | Type  | Fill Of | Width (m) | Depth (m) | Description                            | Finds          | Date |
| 6000  | Layer |         | 2         | 0.3       | Ploughsoil. Mid grey brown sandy clay. | Flint          |      |
| 6001  | Layer |         | 2         |           | Natural. Mid brown orange sandy clay.  |                |      |

#### Trench 61

| General description   |       |         |           |           |   | Orientation    | ENE-WSW |
|---|-------|---------|-----------|-----------|---|----------------|---------|
| Trench devoid of archaeology. Consists of ploughsoil and subsoil overlying natural geology of clay. |       |         |           |           |   | Length (m)     | 30      |
|   |       |         |           |           |   | Width (m)      | 2       |
|   |       |         |           |           |   | Avg. depth (m) | 0.45    |
| Context No.   | Type  | Fill Of | Width (m) | Depth (m) | Description                             | Finds          | Date    |
| 6100  | Layer |         |           | 0.2       | Ploughsoil. Dark grey brown clayey silt |                |         |
| 6101  | Layer |         |           | 0.25      | Subsoil. Mid yellow clay                |                |         |
| 6102  | Layer |         |           |           | Natural. Mid grey yellow clay           |                |         |

#### Trench 62

|                     |  |  |  |  |  |             |     |
|---------------------|--|--|--|--|--|-------------|-----|
| General description |  |  |  |  |  | Orientation | N-S |
|                     |  |  |  |  |  | Length (m)  | 30  |

| Trench revealed a possible plough furrow. Consists of ploughsoil and subsoil overlying natural clay. |       |         |           |           |   | Width (m)      | 2    |
|--|-------|---------|-----------|-----------|---|----------------|------|
|  |       |         |           |           |   | Avg. depth (m) | 0.3  |
| Context No.  | Type  | Fill Of | Width (m) | Depth (m) | Description   | Finds          | Date |
| 6200   | Layer |         |           |           | Natural. Mid brown orange sandy clay.                     |                |      |
| 6201   | Layer |         |           | 0.3       | Ploughsoil. Mid grey brown sandy clay                     |                |      |
| 6202   | Cut   |         | 1.7       | 0.15      | Plough Furrow. Possible plough furrow. Cut by land drain. |                |      |
| 6203   | Fill  | 6202    | 1.7       | 0.15      | Primary Fill. Light grey brown sandy clay                 |                |      |

### Trench 63

| General description   |       |         |           |           |   | Orientation    | NE-SW |
|---|-------|---------|-----------|-----------|---|----------------|-------|
| Trench devoid of archaeology. Consisted of ploughsoil overlying natural geology of silty clay with gravels. |       |         |           |           |   | Length (m)     | 30    |
|   |       |         |           |           |   | Width (m)      | 2     |
|   |       |         |           |           |   | Avg. depth (m) | 36    |
| Context No.   | Type  | Fill Of | Width (m) | Depth (m) | Description                                       | Finds          | Date  |
| 6300  | Layer |         |           | 0.27      | Ploughsoil. Mid grey brown silty clay             | Flint          |       |
| 6301  | Layer |         |           |           | Natural. Mid yellow brown silty clay with gravels |                |       |

### Trench 64

| General description  |       |         |           |           |  | Orientation    | N-S  |
|--|-------|---------|-----------|-----------|--|----------------|------|
| Trench consists of ploughsoil and subsoil overlying natural geology of clayey/sandy silt |       |         |           |           |  | Length (m)     | 30   |
|  |       |         |           |           |  | Width (m)      | 2    |
|  |       |         |           |           |  | Avg. depth (m) | 0.45 |
| Context No.  | Type  | Fill Of | Width (m) | Depth (m) | Description                                    | Finds          | Date |
| 6400   | Layer |         |           | 0.32      | Ploughsoil. Dark grey brown, clayey silt       | Flint          |      |
| 6401   | Layer |         |           | 0.13      | Subsoil. Light yellow brown, clayey silt       |                |      |
| 6402   | Layer |         |           |           | Natural. Light brown yellow, clayey/sandy silt |                |      |

### Trench 65

| General description   |       |         |           |           |                                     | Orientation    | E-W  |
|---|-------|---------|-----------|-----------|-------------------------------------|----------------|------|
| Trench devoid of archaeology. Consists of ploughsoil and subsoil overlying the natural geology of silt clay |       |         |           |           |                                     | Length (m)     | 30   |
|   |       |         |           |           |                                     | Width (m)      | 2    |
|   |       |         |           |           |                                     | Avg. depth (m) | 0.37 |
| Context No.   | Type  | Fill Of | Width (m) | Depth (m) | Description                         | Finds          | Date |
| 6500  | Layer |         |           | 0.25      | Ploughsoil. Mid grey clay silt      |                |      |
| 6501  | Layer |         |           | 0.12      | Subsoil. Mid grey brown silt clay   |                |      |
| 6502  | Layer |         |           |           | Natural. Mid yellow brown silt clay |                |      |

| <b>Trench 66</b>  |       |         |           |           |   |                |      |
|---|-------|---------|-----------|-----------|---|----------------|------|
| General description   |       |         |           |           |   | Orientation    | N-S  |
| Trench devoid of archaeology. Consisted of ploughsoil and sub soil overlying the natural geology of silt clay |       |         |           |           |   | Length (m)     | 30   |
|   |       |         |           |           |   | Width (m)      | 2    |
|   |       |         |           |           |   | Avg. depth (m) | 0.38 |
| Context No.   | Type  | Fill Of | Width (m) | Depth (m) | Description   | Finds          | Date |
| 6600  | Layer |         |           | 0.17      | Ploughsoil. Mid grey clay silt  |                |      |
| 6601  | Layer |         |           | 0.19      | Subsoil. Mid grey brown silt clay   |                |      |
| 6602  | Layer |         |           |           | Natural. Mid yellow brown silt clay   |                |      |
| <b>Trench 67</b>  |       |         |           |           |   |                |      |
| General description   |       |         |           |           |   | Orientation    | E-W  |
| Trench devoid of archaeology. Consists of ploughsoil overlying natural geology of clay.                       |       |         |           |           |   | Length (m)     | 30   |
|   |       |         |           |           |   | Width (m)      | 2    |
|   |       |         |           |           |   | Avg. depth (m) | 0.35 |
| Context No.   | Type  | Fill Of | Width (m) | Depth (m) | Description   | Finds          | Date |
| 6700  | Layer |         |           |           | Natural. Mid brown orange sandy clay.                                       |                |      |
| 6701  | Layer |         |           | 0.3       | Ploughsoil. Mid grey brown sandy clay                                       |                |      |
| <b>Trench 68</b>  |       |         |           |           |   |                |      |
| General description   |       |         |           |           |   | Orientation    | S-N  |
| Trench devoid of archaeology. Consists of ploughsoil overlying natural geology of sandy gravel                |       |         |           |           |   | Length (m)     | 30   |
|   |       |         |           |           |   | Width (m)      | 2    |
|   |       |         |           |           |   | Avg. depth (m) | 0.3  |
| Context No.   | Type  | Fill Of | Width (m) | Depth (m) | Description   | Finds          | Date |
| 6800  | Layer |         |           | 0.3       | Ploughsoil. Dark greyish brown, silty sand                                  |                |      |
| 6801  | Layer |         |           |           | Natural. Light orangish grey, sandy gravel                                  |                |      |
| <b>Trench 69</b>  |       |         |           |           |   |                |      |
| General description   |       |         |           |           |   | Orientation    | E-W  |
| Trench devoid of archaeology. Trench consisted of ploughsoil and subsoil, overlying natural clay and gravel.  |       |         |           |           |   | Length (m)     | 30   |
|   |       |         |           |           |   | Width (m)      | 2    |
|   |       |         |           |           |   | Avg. depth (m) | 0.48 |
| Context No.   | Type  | Fill Of | Width (m) | Depth (m) | Description   | Finds          | Date |
| 6900  | Layer |         |           | 0.33      | Ploughsoil. Dark brownish grey ploughsoil with moderate sub-rounded pebbles |                |      |
| 6901  | Layer |         |           | 0.19      | Subsoil. Mid yellow brown silt clay with frequent sub-rounded pebbles       |                |      |
| 6902  | Layer |         |           |           | Natural. Mid brown orange natural clay.                                     |                |      |

| <b>Trench 70</b>  |                     |         |           |           |  |                |       |
|---|---------------------|---------|-----------|-----------|--|----------------|-------|
| General description   |                     |         |           |           |  | Orientation    | E-W   |
| Trench devoid of archaeology. Consisted of ploughsoil and subsoil, overlying natural deposits of clay and gravels.          |                     |         |           |           |  | Length (m)     | 30    |
|   |                     |         |           |           |  | Width (m)      | 2     |
|   |                     |         |           |           |  | Avg. depth (m) | 0.28  |
| Context No.   | Type                | Fill Of | Width (m) | Depth (m) | Description  | Finds          | Date  |
| 7000  | Layer               |         |           | 0.23      | Ploughsoil. Dark grey brown silty clay                                   |                |       |
| 7001  | Layer               |         |           | 0.05      | Subsoil. Mid yellow clay   |                |       |
| 7002  | Layer               |         |           |           | Natural. Reddish grey gravelly clay                                      |                |       |
| <b>Trench 71</b>  |                     |         |           |           |  |                |       |
| General description   |                     |         |           |           |  | Orientation    | SW-NE |
| Trench revealed four ditches and a natural feature. Consisted of ploughsoil and subsoil, overlying natural sand and gravel. |                     |         |           |           |  | Length (m)     | 30    |
|   |                     |         |           |           |  | Width (m)      | 2     |
|   |                     |         |           |           |  | Avg. depth (m) | 0.51  |
| Context No.   | Type                | Fill Of | Width (m) | Depth (m) | Description  | Finds          | Date  |
| 7100  | Layer               |         |           | 0.39      | Ploughsoil. Dark brownish grey ploughsoil. Frequent sub-rounded pebbles. |                |       |
| 7101  | Layer               |         |           | 0.12      | Subsoil. Orange-brown clay sand. Frequent gravel                         |                |       |
| 7102  | Layer               |         |           |           | Natural. Orange yellow natural sand                                      |                |       |
| 7103  | Cut                 |         | 1.58      | 0.26      | Ditch  |                |       |
| 7104  | Fill                | 7103    | 1.58      | 0.26      | Primary Fill. Mid brownish grey, silty sand                              |                |       |
| 7105  | Cut                 |         | 1.54      | 0.62      | Ditch  |                |       |
| 7106  | Fill                | 7105    | 0.74      | 0.12      | Primary Fill. Light whitish orange, silty sand                           |                |       |
| 7107  | Fill                | 7105    | 1         | 0.2       | Secondary Fill. Light brownish grey, sandy gravel                        |                |       |
| 7108  | Fill                | 7105    | 0.84      | 0.4       | Deliberate Backfill. Light orangish brown, sandy clay                    |                |       |
| 7109  | Fill                | 7105    | 1.38      | 0.26      | Tertiary Fill. Mid orangish-brown, silty sand                            |                |       |
| 7110  | Cut                 |         | 1.08      | 0.2       | Ditch  |                |       |
| 7111  | Fill                | 7110    | 1.08      | 0.2       | Primary Fill. Mid brownish grey, silty sand                              |                |       |
| 7112  | Unexcavated feature |         | 3.1       |           | Ditch. Mid orangish brown, silty sand                                    |                |       |
| 7113  | Unexcavated feature |         | 1.48      |           | Natural Feature. Mid brownish yellow, silty clay                         |                |       |
| <b>Trench 72</b>  |                     |         |           |           |  |                |       |
| General description   |                     |         |           |           |  | Orientation    | NE-SW |
| Trench revealed two ditches, one left unexcavated. Ploughsoil overlying sand and gravel geology.                            |                     |         |           |           |  | Length (m)     | 30    |
|   |                     |         |           |           |  | Width (m)      | 2     |
|   |                     |         |           |           |  | Avg. depth (m) | 0.3   |

| Context No. | Type                | Fill Of | Width (m) | Depth (m) | Description   | Finds | Date   |
|-------------|---------------------|---------|-----------|-----------|---|-------|--------|
| 7200        | Layer               |         |           | 0.3       | Ploughsoil. Dark grey brown, clay silt  |       |        |
| 7201        | Layer               |         |           |           | Natural. Red yellow gravels   |       |        |
| 7202        | Cut                 |         | 2.9       | 0.52      | Ditch   |       |        |
| 7203        | Fill                | 7202    | 1.62      | 0.4       | Deliberate Backfill. Mid brownish grey, clayey sand, 5% gravel. Over lies 7204                      |       |        |
| 7204        | Fill                | 7202    | 0.3       | 0.24      | Deliberate Backfill. Mid yellowish brown silty gravel, 5% rounded stones. Overlain by 7203          |       |        |
| 7205        | Fill                | 7202    | 1.11      | 0.26      | Deliberate Backfill. Mid brownish grey clayey sand, lenses of rounded gravels. Over lies layer 7206 |       |        |
| 7206        | Fill                | 7202    | 0.9       | 0.1       | Deliberate Backfill. Mid whitish grey clayey silt, 5% > gravel. Lies beneath 7205                   |       |        |
| 7207        | Unexcavated feature |         | 2.8       |           | Ditch. Linear running north-south. Mid grey brown   | Pot   | LIA-ER |

### Trench 73

| General description   | Orientation    | NE-SW |
|---|----------------|-------|
| Trench revealed one ditch. Consisted of ploughsoil and subsoil overlying natural geology of sandy gravel. | Length (m)     | 30    |
|   | Width (m)      | 2.2   |
|   | Avg. depth (m) | 0.43  |

| Context No. | Type  | Fill Of | Width (m) | Depth (m) | Description   | Finds | Date |
|-------------|-------|---------|-----------|-----------|---|-------|------|
| 7300        | Layer |         |           | 0.3       | Ploughsoil. Dark grey brown, clay silt.                   |       |      |
| 7301        | Layer |         |           | 0.13      | Subsoil. Mid orangey brown, clay silt.                    |       |      |
| 7302        | Cut   |         | 1.8       | 0.5       | Ditch. Boundary ditch                                     |       |      |
| 7303        | Cut   |         | 0.2       | 0.35      | Modern. Field drain                                       |       |      |
| 7304        | Fill  | 7302    | 1.5       | 0.3       | Secondary Fill. Light grey, sand                          |       |      |
| 7305        | Fill  | 7302    | 1.8       | 0.2       | Secondary Fill. Dark grey brown, sand                     |       |      |
| 7306        | Fill  | 7303    | 0.2       | 0.35      | Deliberate Backfill. Very mixed, plough soil and natural. |       |      |
| 7307        | Layer |         |           |           | Natural. Light yellow brown, sandy gravel                 |       |      |

### Trench 74

| General description  | Orientation    | E-W  |
|--|----------------|------|
| Trench revealed three ditches and three pits. Trench consisted of ploughsoil overlying natural geology of sandy gravel | Length (m)     | 50   |
|  | Width (m)      | 2    |
|  | Avg. depth (m) | 0.28 |

| Context No. | Type  | Fill Of | Width (m) | Depth (m) | Description                                | Finds | Date |
|-------------|-------|---------|-----------|-----------|--|-------|------|
| 7400        | Layer |         |           | 0.28      | Ploughsoil. Dark greyish brown, silty sand |       |      |
| 7401        | Layer |         |           |           | Natural. Mid orangish brown, sandy gravel  |       |      |

|      |                     |      |      |      |   |                   |        |
|------|---------------------|------|------|------|---|-------------------|--------|
| 7402 | Cut                 |      | 1.88 | 0.3  | Ditch   |                   |        |
| 7403 | Fill                | 7402 | 0.72 | 0.2  | Secondary Fill. Dark grey brown silty sand  | Pot               | LIA-ER |
| 7404 | Cut                 |      | 3.12 | 0.6  | Ditch   |                   |        |
| 7405 | Fill                | 7404 | 2.06 | 0.16 | Secondary Fill. Mid blueish grey silty Sand, friable, with occasional small pebbles                                 |                   |        |
| 7406 | Fill                | 7404 | 2.9  | 0.22 | Secondary Fill. Dark brownish Red Sandy silt, firm, with huge amount of pebbles and iron-manganese concretion in it |                   |        |
| 7407 | Fill                | 7404 | 2.78 | 0.24 | Secondary Fill. Light yellowish grey Sand with occasional pebble in it  |                   |        |
| 7408 | Fill                | 7404 | 3.02 | 0.58 | Secondary Fill. Dark brownish grey clayey silt, smooth, with occasional pebble in it                                | Pot               | 40-410 |
| 7409 | Cut                 |      | 1.24 | 0.24 | Pit   |                   |        |
| 7410 | Fill                | 7409 | 1.24 | 0.24 | Secondary Fill. Mid yellow brown gravelly sand  |                   |        |
| 7411 | Cut                 |      | 0.54 | 0.23 | Pit   |                   |        |
| 7412 | Fill                | 7411 | 0.54 | 0.23 | Secondary Fill. Dark grey brown silty sand  | Pot, Oyster shell | PMed   |
| 7413 | Unexcavated feature |      | 10.1 |      | Ditch. Mid brown, clayey silt.  |                   |        |
| 7414 | Unexcavated feature |      | 1.2  |      | Pit. Dark greyish brown, clayey silt.   |                   |        |
| 7415 | Fill                | 7402 | 1.88 | 0.3  | Secondary Fill. Dark brown grey, sandy silt.  |                   |        |

### Trench 76

| General description   |       |         |           |           |  | Orientation    | SW-NE |
|---|-------|---------|-----------|-----------|--|----------------|-------|
| Trench revealed six intercutting ditches. Trench consisted of ploughsoil and subsoil overlying natural geology of silty sand with gravel. |       |         |           |           |  | Length (m)     | 30    |
|   |       |         |           |           |  | Width (m)      | 2     |
|   |       |         |           |           |  | Avg. depth (m) | 0.48  |
| Context No.   | Type  | Fill Of | Width (m) | Depth (m) | Description  | Finds          | Date  |
| 7600  | Layer |         |           | 0.28      | Ploughsoil. Dark greyish brown, silty sand with gravel                                     |                |       |
| 7601  | Layer |         |           | 0.21      | Subsoil. Mid orangish brown, silty sand  |                |       |
| 7602  | Layer |         |           |           | Natural. Light yellowish brown mixed with orangish patches, silty sand with gravel patches |                |       |
| 7603  | Cut   |         | 0.53      | 0.19      | Ditch  |                |       |
| 7604  | Fill  | 7603    | 0.53      | 0.19      | Primary Fill. Mid brown grey, silty sand.  |                |       |
| 7605  | Cut   |         | 0.8       | 0.26      | Ditch  |                |       |
| 7606  | Fill  | 7605    | 0.8       | 0.26      | Secondary Fill. Mid brown grey, silty sand.  |                |       |
| 7607  | Cut   |         | 1.02      | 0.32      | Ditch  |                |       |
| 7608  | Fill  | 7607    | 1.02      | 0.32      | Primary Fill. Mid brown grey, silty sand.  |                |       |
| 7609  | Cut   |         | 0.89      | 0.27      | Ditch  |                |       |
| 7610  | Fill  | 7609    | 0.89      | 0.27      | Primary Fill. Light brown grey, silty sand.  |                |       |



| 7611   | Cut                 |         | 1.66      | 0.42      | Ditch  |                                |         |
|--|---------------------|---------|-----------|-----------|--|--------------------------------|---------|
| 7612   | Fill                | 7611    | 1.66      | 0.42      | Primary Fill. Mid brown grey, silty sand.                    |                                |         |
| <b>Trench 77</b>   |                     |         |           |           |  |                                |         |
| General description  |                     |         |           |           |  | Orientation                    | NW-SE   |
| Trench consisted of a N-S running ditch, an area of burnt material and a partial ring ditch. Ploughsoil and subsoil overlying natural sand and gravel geology. |                     |         |           |           |  | Length (m)                     | 19.6    |
|  |                     |         |           |           |  | Width (m)                      | 14.7    |
|  |                     |         |           |           |  | Avg. depth (m)                 | 0.4     |
| Context No.  | Type                | Fill Of | Width (m) | Depth (m) | Description  | Finds                          | Date    |
| 7700   | Layer               |         |           | 0.29      | Ploughsoil. Dark brownish grey, clayey silt.                 |                                |         |
| 7701   | Layer               |         |           | 0.13      | Subsoil. Mid yellowish brown, silty clay.                    |                                |         |
| 7702   | Layer               |         |           |           | Natural. Light grey yellow, sandy gravel.                    |                                |         |
| 7703   | Cut                 |         | 1.52      | 0.51      | Ditch  |                                |         |
| 7704   | Fill                | 7703    | 1.52      | 0.51      | Secondary Fill. Mid yellow brown, sandy silt.                | Pot, FC firebar                | LIA-ER  |
| 7705   | Cut                 |         | 0.54      | 0.42      | Ditch  |                                |         |
| 7706   | Fill                | 7705    | 0.54      | 0.42      | Secondary Fill. Mid grey brown, sandy silt.                  | Pot                            | 40-410  |
| 7707   | Cut                 |         | 1.41      | 0.28      | Pit  |                                |         |
| 7708   | Fill                | 7707    | 1.41      | 0.28      | Deliberate Backfill. Black, charcoal.                        | Flint, Burnt Flint, Sample <2> |         |
| 7709   | Cut                 |         | 0.33      | 0.31      | Ditch  |                                |         |
| 7710   | Fill                | 7709    | 0.33      | 0.31      | Secondary Fill. Mid orange brown, sandy silt.                | FC Wattle ?                    |         |
| 7711   | Cut                 |         | 0.54      | 0.31      | Ditch  |                                |         |
| 7712   | Fill                | 7711    | 0.54      | 0.31      | Secondary Fill. Mid orange brown, sandy silt.                |                                |         |
| 7713   | Cut                 |         | 0.4       | 0.4       | Pit  |                                |         |
| 7714   | Fill                | 7713    | 0.4       | 0.4       | Secondary Fill. Mid orange brown, clayey silt.               |                                |         |
| 7715   | Fill                | 7707    | 1.31      | 0.1       | Tertiary Fill. Mid yellow brown, sandy silt.                 |                                |         |
| 7716   | Fill                | 7707    | 0.23      | 0.41      | Primary Fill. Mid orange brown, silty sand.                  |                                |         |
| 7717   | Cut                 |         | 1.19      | 0.62      | Ditch  |                                |         |
| 7718   | Fill                | 7717    | 1.19      | 0.62      | Secondary Fill. Mid grey brown, sandy silt.                  | Pot                            | MIA-LIA |
| 7719   | Layer               |         |           | 0.16      | Buried soil. Mid grey orange brown, sandy silt.              |                                |         |
| 7720   | Cut                 |         | 1.54      | 0.36      | Ditch  |                                |         |
| 7721   | Fill                | 7720    | 1.54      | 0.36      | Secondary Fill. Mid greyish brown Silty sand Moderate gravel |                                |         |
| 7722   | Unexcavated feature |         | 0.38      |           | Ditch. Mid greyish brown, silty sand                         |                                |         |
| 7723   | Unexcavated feature |         | 0.4       |           | Ditch. Mid greyish brown, silty sand                         | Flint                          |         |
| 7724   | Unexcavated feature |         | 0.34      |           | Ditch. Mid greyish brown, silty sand                         |                                |         |
| 7725   | Unexcavated feature |         |           |           | Ditch. Mid greyish brown, silty sand                         |                                |         |

| Trench 78  |                     |         |           |           |  |                             |       |
|--|---------------------|---------|-----------|-----------|--|-----------------------------|-------|
| General description  |                     |         |           |           |  | Orientation                 | NW-SE |
| Trench revealed five ditches, a single posthole at the southern end, and seven pits. Consisted of ploughsoil overlying natural geology of silty sand and gravel. |                     |         |           |           |  | Length (m)                  | 30    |
|  |                     |         |           |           |  | Width (m)                   | 2.2   |
|  |                     |         |           |           |  | Avg. depth (m)              | 0.44  |
| Context No.  | Type                | Fill Of | Width (m) | Depth (m) | Description  | Finds                       | Date  |
| 7800   | Layer               |         |           | 0.32      | Ploughsoil. Mid brown grey sandy silt with occasional rounded pebbles                  |                             |       |
| 7801   | Layer               |         |           |           | Natural. Light yellow orange sand with patches of light greyish yellow rounded pebbles |                             |       |
| 7802   | Cut                 |         | 0.34      | 0.1       | Posthole   |                             |       |
| 7803   | Fill                | 7802    | 0.34      | 0.1       | Secondary Fill. Mid greyish brown, silty sand  |                             |       |
| 7804   | Cut                 |         | 1.31      | 0.42      | Ditch  |                             |       |
| 7805   | Fill                | 7804    | 0.5       | 0.1       | Primary Fill. Mid reddish brown, silty sand  |                             |       |
| 7806   | Fill                | 7804    | 1.22      | 0.42      | Secondary Fill. Mid-dark greyish brown, silty sand                                     | Flint, 1BF, Pot, Sample <1> | MIA   |
| 7807   | Cut                 |         | 0.26      | 0.24      | Ditch  |                             |       |
| 7808   | Fill                | 7807    | 0.26      | 0.24      | Secondary Fill. Dark greyish brown, silty sand   |                             |       |
| 7809   | Cut                 |         | 0.86      | 0.53      | Pit  |                             |       |
| 7810   | Cut                 |         | 0.4       | 0.23      | Ditch  |                             |       |
| 7811   | Fill                | 7810    | 0.4       | 0.23      | Secondary Fill. Light-mid greyish brown, silty sand                                    |                             |       |
| 7812   | Fill                | 7809    | 1.05      | 0.28      | Primary Fill. Light brownish grey, silty sand  |                             |       |
| 7813   | Fill                | 7809    | 1         | 0.36      | Secondary Fill. Mid greyish brown, silty sand  |                             |       |
| 7814   | Cut                 |         | 0.35      | 0.17      | Pit  |                             |       |
| 7815   | Fill                | 7814    | 0.35      | 0.17      | Secondary Fill. Mid-dark greyish brown, silty sand                                     | Flint                       |       |
| 7816   | Cut                 |         | 0.5       | 0.21      | Pit  |                             |       |
| 7817   | Fill                | 7816    | 0.5       | 0.21      | Secondary Fill. Mid greyish brown, silty sand  |                             |       |
| 7818   | Unexcavated feature |         | 1.72      |           | Pit. Mid greyish brown, silty sand with frequent gravel                                |                             |       |
| 7819   | Unexcavated feature |         | 0.24      |           | Ditch. Mid-dark greyish brown, silty sand  |                             |       |
| 7820   | Unexcavated feature |         | 1.8       |           | Pit. Mid greyish brown, silty sand with moderate gravel                                |                             |       |
| 7821   | Unexcavated feature |         | 0.5       |           | Pit. Mid-dark greyish brown, silty sand  |                             |       |
| 7822   | Unexcavated feature |         | 0.76      |           | Pit. Mid greyish and reddish brown, silty sand   | Flint                       |       |
| 7823   | Cut                 |         | 2.1       | 0.48      | Ditch  |                             |       |
| 7824   | Fill                | 7823    | 1         | 0.19      | Primary Fill. Light brownish grey, silty sand  |                             |       |
| 7825   | Fill                | 7823    | 2.1       | 0.29      | Secondary Fill. Mid greyish brown, silty sand  | Pot                         | MIA   |
| Trench 79  |                     |         |           |           |  |                             |       |

| General description   |       |         |           |           |  | Orientation    | NE-SW |
|---|-------|---------|-----------|-----------|--|----------------|-------|
| Trench revealed two ditches. Consisted of ploughsoil and subsoil overlying sand and gravel geology. |       |         |           |           |  | Length (m)     | 30    |
|   |       |         |           |           |  | Width (m)      | 2.2   |
|   |       |         |           |           |  | Avg. depth (m) | 0.45  |
| Context No.   | Type  | Fill Of | Width (m) | Depth (m) | Description  | Finds          | Date  |
| 7900  | Layer |         |           | 0.4       | Ploughsoil. Mid greyish brown sandy silt with occasional rounded pebbles |                |       |
| 7901  | Layer |         |           |           | Natural. Dark yellowish orange sandy gravel                              |                |       |
| 7902  | Cut   |         | 0.21      | 0.06      | Ditch  |                |       |
| 7903  | Fill  | 7902    | 0.21      | 0.06      | Primary Fill. Dark grey orange, silty sand.                              |                |       |
| 7904  | Cut   |         | 0.44      | 0.15      | Ditch  |                |       |
| 7905  | Fill  |         | 0.44      | 0.15      | Primary Fill. Light orange grey, silty sand.                             |                |       |

#### Trench 80

| General description   |       |         |           |           |  | Orientation    | N-S  |
|---|-------|---------|-----------|-----------|--|----------------|------|
| Trench revealed one linear. Consisted of ploughsoil onto sand and gravel geology. |       |         |           |           |  | Length (m)     | 30   |
|   |       |         |           |           |  | Width (m)      | 2    |
|   |       |         |           |           |  | Avg. depth (m) | 0.35 |
| Context No.   | Type  | Fill Of | Width (m) | Depth (m) | Description                                | Finds          | Date |
| 8000  | Layer |         |           | 0.35      | Ploughsoil. Mid greyish brown sandy silt   |                |      |
| 8001  | Layer |         |           |           | Natural. Dark yellowish orange             |                |      |
| 8002  | Cut   |         | 0.78      | 0.24      | Ditch                                      |                |      |
| 8003  | Fill  | 8002    | 0.78      | 0.24      | Primary Fill. Mid brown grey, clayey sand. |                |      |

#### Trench 81

| General description  |       |         |           |           |   | Orientation    | NW-SE   |
|--|-------|---------|-----------|-----------|---|----------------|---------|
| Trench contained two ditches, both terminating, and a pit. Consisted of ploughsoil overlying natural geology of sand and gravel. |       |         |           |           |   | Length (m)     | 30      |
|  |       |         |           |           |   | Width (m)      | 2       |
|  |       |         |           |           |   | Avg. depth (m) | 0.37    |
| Context No.  | Type  | Fill Of | Width (m) | Depth (m) | Description   | Finds          | Date    |
| 8100   | Layer |         |           | 0.27      | Ploughsoil. Mid grey brown, clayey silt, friable, occasional stones               |                |         |
| 8101   | Layer |         |           | 0.1       | Natural. Mid brown yellow, compact sandy clay mixed with loose grey brown gravels |                |         |
| 8102   | Cut   |         | 0.5       | 0.1       | Ditch   |                |         |
| 8103   | Fill  | 8102    | 0.5       | 0.1       | Secondary Fill. Light brownish grey, sandy gravel.                                |                |         |
| 8104   | Cut   |         | 0.24      | 0.1       | Pit   |                |         |
| 8105   | Fill  | 8104    | 0.52      | 0.1       | Secondary Fill. Mid greyish brown, sandy silt gravel.                             | Pot            | LIA-Rom |

|  |       |         |           |           |   |                |       |
|--|-------|---------|-----------|-----------|---|----------------|-------|
| 8106   | Cut   |         | 0.38      | 0.16      | Ditch   |                |       |
| 8107   | Fill  | 8106    | 0.38      | 0.16      | Secondary Fill. Light brownish grey, silty sand gravel. | Pot            | PMed  |
| <b>Trench 82</b>   |       |         |           |           |   |                |       |
| General description  |       |         |           |           |   | Orientation    | NE-SW |
| Trench devoid of archaeology. Consisting of ploughsoil overlying natural clay                  |       |         |           |           |   | Length (m)     | 30    |
|  |       |         |           |           |   | Width (m)      | 2     |
|  |       |         |           |           |   | Avg. depth (m) | 0.37  |
| Context No.  | Type  | Fill Of | Width (m) | Depth (m) | Description   | Finds          | Date  |
| 8200   | Layer |         |           | 0.27      | Ploughsoil. Mid grey brown, clayey silt.                |                |       |
| 8201   | Layer |         |           | 0.1       | Natural. Mid brown yellow, sandy clay.                  |                |       |
| <b>Trench 83</b>   |       |         |           |           |   |                |       |
| General description  |       |         |           |           |   | Orientation    | NE-SW |
| Trench devoid of archaeology. Consisted of ploughsoil overlying natural geology of silty clay. |       |         |           |           |   | Length (m)     | 30    |
|  |       |         |           |           |   | Width (m)      | 2     |
|  |       |         |           |           |   | Avg. depth (m) | 0.29  |
| Context No.  | Type  | Fill Of | Width (m) | Depth (m) | Description   | Finds          | Date  |
| 8300   | Layer |         |           | 0.21      | Ploughsoil. Mid grey brown, silty clay.                 |                |       |
| 8301   | Layer |         |           |           | Natural. Mid yellow brown, silty clay with gravels.     |                |       |
| <b>Trench 84</b>   |       |         |           |           |   |                |       |
| General description  |       |         |           |           |   | Orientation    | N-S   |
| Trench devoid of archaeology. Ploughsoil and subsoil overlying natural clay geology.           |       |         |           |           |   | Length (m)     | 30    |
|  |       |         |           |           |   | Width (m)      | 2     |
|  |       |         |           |           |   | Avg. depth (m) | 0.5   |
| Context No.  | Type  | Fill Of | Width (m) | Depth (m) | Description   | Finds          | Date  |
| 8400   | Layer |         |           | 0.3       | Ploughsoil. Dark grey brown, clayey silt.               |                |       |
| 8401   | Layer |         |           | 0.2       | Subsoil. Mid brown yellow, clayey silt.                 |                |       |
| 8402   | Layer |         |           |           | Natural. Mid brown yellow, silty clay.                  |                |       |
| <b>Trench 85</b>   |       |         |           |           |   |                |       |
| General description  |       |         |           |           |   | Orientation    | E-W   |
| Trench devoid of archaeology. Ploughsoil and subsoil overlying natural clay geology.           |       |         |           |           |   | Length (m)     | 30    |
|  |       |         |           |           |   | Width (m)      | 2     |
|  |       |         |           |           |   | Avg. depth (m) |       |
| Context No.  | Type  | Fill Of | Width (m) | Depth (m) | Description   | Finds          | Date  |
| 8500   | Layer |         |           | 0.22      | Ploughsoil. Dark brown grey, clayey silt.               |                |       |

|  |                     |         |           |           |   |   |        |
|--|---------------------|---------|-----------|-----------|---|---|--------|
| 8501   | Layer               |         |           | 0.2       | Subsoil. Mid brown yellow, clayey silt.   |   |        |
| 8502   | Layer               |         |           |           | Natural. Mid yellow brown, silty clay.  |   |        |
| <b>Trench 86</b>   |                     |         |           |           |   |   |        |
| General description  |                     |         |           |           |   | Orientation                                     | N-S    |
| Trench devoid of archaeology. Ploughsoil and subsoil overlying natural clay geology.         |                     |         |           |           |   | Length (m)                                      | 30     |
|  |                     |         |           |           |   | Width (m)                                       | 2      |
|  |                     |         |           |           |   | Avg. depth (m)                                  | 0.43   |
| Context No.  | Type                | Fill Of | Width (m) | Depth (m) | Description   | Finds   | Date   |
| 8600   | Layer               |         |           | 0.25      | Ploughsoil. Dark grey, clayey silt.   |   |        |
| 8601   | Layer               |         |           | 0.2       | Subsoil. Mid brown yellow, silty clay.  |   |        |
| 8602   | Layer               |         |           |           | Natural. Mid yellow brown, silty clay.  |   |        |
| <b>Trench 87</b>   |                     |         |           |           |   |   |        |
| General description  |                     |         |           |           |   | Orientation                                     | E-W    |
| Trench revealed a possible cremation. Ploughsoil and subsoil overlying natural clay geology. |                     |         |           |           |   | Length (m)                                      | 30     |
|  |                     |         |           |           |   | Width (m)                                       | 2      |
|  |                     |         |           |           |   | Avg. depth (m)                                  | 0.3    |
| Context No.  | Type                | Fill Of | Width (m) | Depth (m) | Description   | Finds   | Date   |
| 8700   | Layer               |         |           | 0.3       | Ploughsoil. Dark grey brown, sandy silt.  | Sample <4>                                      |        |
| 8701   | Layer               |         |           |           | Natural   |   |        |
| 8702   | Group               |         | 0.42      | 0.2       | Truncated by machine, in south facing baulk. Burnt bone, charcoal, ash  |   |        |
| 8703   | Void                |         |           |           |   |   |        |
| 8704   | Cut                 |         | 0.42      | 0.2       | Pit Cut   |   |        |
| 8705   | Fill                | 8704    | 0.42      | 0.2       | Loose, black (charcoal) fill with a little burnt bone.  | Nails and CU alloy wire. Samples <5>, <6> & <7> | Modern |
| 8706   | Void                |         |           |           |   |   |        |
| 8707   | Unexcavated feature |         |           |           | Possible pit. Dark red brown silty clay, charcoal.  | Flints x 2                                      |        |
| 8708   | Layer               |         |           | 0.05      | Subsoil. Mixed dark brown and orange silt clay and frequent charcoal. Plough disturbed horizon overlying pit 8704.        | Pot, AB, Samples <8>, <11> & <12>               | LIA-ER |
| 8709   | Layer               |         |           |           | Natural. Appeared 'terminus shaped' at surface. Cleaning revealed its extent and relationship as variation in the natural |   |        |
| <b>Trench 88</b>   |                     |         |           |           |   |   |        |
| General description  |                     |         |           |           |   | Orientation                                     | E-W    |
| Trench revealed two ditches. Consisted of ploughsoil overlying sandy clay geology.           |                     |         |           |           |   | Length (m)                                      | 30     |

|             |                     |         |           |           |  | Width (m)      | 2    |
|-------------|---------------------|---------|-----------|-----------|--|----------------|------|
|             |                     |         |           |           |  | Avg. depth (m) | 0.4  |
| Context No. | Type                | Fill Of | Width (m) | Depth (m) | Description  | Finds          | Date |
| 8800        | Layer               |         |           | 0.3       | Ploughsoil. Mid grey brown silty clay. Plastic when wet. Occ flint gravel. |                |      |
| 8801        | Layer               |         |           |           | Natural. Mid brown orange sandy clay. Occ flint gravel.                    |                |      |
| 8802        | Unexcavated feature |         |           |           | Ditch. Post medieval boundary.   |                |      |
| 8803        | Unexcavated feature |         | 0.3       |           | Modern. Probable land drain.   |                |      |

#### Trench 89

| General description  |       |         |           |           |  | Orientation    | NW-SE   |
|--|-------|---------|-----------|-----------|--|----------------|---------|
| Trench devoid of archaeology. Consisted of ploughsoil overlying natural clay |       |         |           |           |  | Length (m)     | 30      |
|  |       |         |           |           |  | Width (m)      | 2       |
|  |       |         |           |           |  | Avg. depth (m) | 0.34    |
| Context No.  | Type  | Fill Of | Width (m) | Depth (m) | Description  | Finds          | Date    |
| 8900   | Layer |         |           | 0.3       | Ploughsoil. Mid grey brown, clayey silt, friable, occasional stones. Overlying the natural clay      | Flint kife     | Neo-EBA |
| 8901   | Layer |         |           | 0.05      | Natural. Mid orange yellow, sandy clay, compact, inclusions of rounded stones. Underlying ploughsoil |                |         |

#### Trench 90

| General description   |       |         |           |           |   | Orientation    | NE-SW |
|---|-------|---------|-----------|-----------|---|----------------|-------|
| Trench is devoid of archaeology. Consisted of ploughsoil overlying natural yellow clay. |       |         |           |           |   | Length (m)     | 30    |
|   |       |         |           |           |   | Width (m)      | 2     |
|   |       |         |           |           |   | Avg. depth (m) | 0.32  |
| Context No.   | Type  | Fill Of | Width (m) | Depth (m) | Description   | Finds          | Date  |
| 9000  | Layer |         |           | 0.29      | Ploughsoil. Mid grey brown, clayey silt, friable, occasional stones, overlying natural clay   |                |       |
| 9001  | Layer |         |           | 0.03      | Natural. Mid brown yellow, sandy clay, compact, inclusions of rounded stones. Plough scars cutting the natural run the length of the trench. Underlying the plough soil |                |       |

#### Trench 91

|  |  |  |  |  |  |                |       |
|--|--|--|--|--|--|----------------|-------|
| General description  |  |  |  |  |  | Orientation    | NW-SE |
| Trench revealed no archaeology. A spread of gravel was tested. Consisted of ploughsoil overlying sandy clay geology. |  |  |  |  |  | Length (m)     | 30    |
|  |  |  |  |  |  | Width (m)      | 2     |
|  |  |  |  |  |  | Avg. depth (m) | 0.4   |

| Context No. | Type  | Fill Of | Width (m) | Depth (m) | Description  | Finds | Date |
|-------------|-------|---------|-----------|-----------|--|-------|------|
| 9100        | Layer |         |           | 0.32      | Ploughsoil. Mid grey brown, clayey silt, friable, occasional stones            |       |      |
| 9101        | Layer |         |           | 0.08      | Natural. Mid brown yellow, sandy clay, compact, frequent stones                |       |      |
| 9102        | Layer |         | 0.6       | 0.2       | Other Layer. Natural gravel patch, in sand, excavated to prove not archaeology |       |      |

#### Trench 92

|   |                |       |
|---|----------------|-------|
| General description   | Orientation    | SW-NE |
| Trench devoid of archaeology. Contained one area of mid whitish grey gravel and one area rich in manganese possibly from rooting. Consisted of ploughsoil overlying sandy clay geology. | Length (m)     | 30    |
|   | Width (m)      | 2     |
|   | Avg. depth (m) | 0.41  |

| Context No. | Type  | Fill Of | Width (m) | Depth (m) | Description   | Finds | Date |
|-------------|-------|---------|-----------|-----------|---|-------|------|
| 9200        | Layer |         |           | 0.3       | Ploughsoil. Mid grey brown, clayey silt, friable, occasional stones |       |      |
| 9201        | Layer |         |           | 0.11      | Natural. Mid brown yellow sandy clay, compact, inclusions of stones |       |      |
| 9202        | Cut   |         | 3.2       | 0.25      | Pit   |       |      |
| 9203        | Fill  | 9202    |           | 0.18      | Primary Fill. Light grey fairly pure sand.                          |       |      |
| 9204        | Fill  | 9202    | 3.2       | 0.09      | Secondary Fill. Mid grey sand.                                      |       |      |
| 9205        | Layer |         | 5         | 0.35      | Natural. Mixed grey brown, gravelly sand.                           |       |      |

#### Trench 93

|   |                |       |
|---|----------------|-------|
| General description   | Orientation    | NW-SE |
| Trench devoid of archaeology. Consisted of ploughsoil and natural sandy clay. | Length (m)     | 30    |
|   | Width (m)      | 2     |
|   | Avg. depth (m) | 0.32  |

| Context No. | Type  | Fill Of | Width (m) | Depth (m) | Description                              | Finds | Date |
|-------------|-------|---------|-----------|-----------|--|-------|------|
| 9300        | Layer |         |           | 0.22      | Ploughsoil. Mid grey brown, clayey silt. |       |      |
| 9301        | Layer |         |           | 0.1       | Natural. Mid brown yellow, clayey sand.  |       |      |

#### Trench 94

|  |                |       |
|--|----------------|-------|
| General description  | Orientation    | NE-SW |
| Trench is devoid of archaeology. Consisted of ploughsoil overlying natural clay. | Length (m)     | 30    |
|  | Width (m)      | 2     |
|  | Avg. depth (m) | 0.33  |

| Context No. | Type  | Fill Of | Width (m) | Depth (m) | Description                              | Finds | Date |
|-------------|-------|---------|-----------|-----------|--|-------|------|
| 9400        | Layer |         |           | 0.23      | Ploughsoil. Mid grey brown, clayey silt. |       |      |

|   |       |         |           |           |  |                  |         |
|---|-------|---------|-----------|-----------|--|------------------|---------|
| 9401  | Layer |         |           | 0.1       | Natural. Mid brown yellow, sandy clay.   |                  |         |
| <b>Trench 95</b>  |       |         |           |           |  |                  |         |
| General description   |       |         |           |           |  | Orientation      | NW-SE   |
| Trench contained one possible tree throw on the NW end. Trench consists of ploughsoil overlying natural geology of Sandy clay and gravel.                           |       |         |           |           |  | Length (m)       | 30      |
|   |       |         |           |           |  | Width (m)        | 2       |
|   |       |         |           |           |  | Avg. depth (m)   | 0.38    |
| Context No.   | Type  | Fill Of | Width (m) | Depth (m) | Description  | Finds            | Date    |
| 9500  | Layer |         |           | 0.3       | Ploughsoil. Mid brown grey, clayey silt, friable, occasional stones                        |                  |         |
| 9501  | Layer |         |           | 0.08      | Natural. Mid brown yellow, sandy clay, frequent stones, compact, occasional gravel patches |                  |         |
| 9502  | Cut   |         | 1.6       | 0.22      | Tree Throw   |                  |         |
| 9503  | Fill  | 9502    | 1.6       | 0.22      | Secondary Fill. Mid whitish grey, sandy silt.  |                  |         |
| <b>Trench 96</b>  |       |         |           |           |  |                  |         |
| General description   |       |         |           |           |  | Orientation      | NE-SW   |
| Trench contained two ditches, one tree throw with a worked flint and a cremation. Trench consists of ploughsoil overlying natural geology of Sandy clay and gravel. |       |         |           |           |  | Length (m)       | 30      |
|   |       |         |           |           |  | Width (m)        | 2       |
|   |       |         |           |           |  | Avg. depth (m)   | 0.4     |
| Context No.   | Type  | Fill Of | Width (m) | Depth (m) | Description  | Finds            | Date    |
| 9600  | Layer |         |           | 0.3       | Ploughsoil. Mid grey brown, clayey silt.   |                  |         |
| 9601  | Layer |         |           | 0.1       | Natural. Mid brown yellow, sandy clay.   |                  |         |
| 9602  | Cut   |         | 1.9       | 0.28      | Tree-Throw hole  |                  |         |
| 9603  | Fill  | 9602    | 1.9       | 0.28      | Primary Fill. Light yellow grey, clayey sand.  | Flint            | Neo-EBA |
| 9604  | Fill  | 9606    | 2.2       | 0.36      | Secondary Fill. Light brown grey, clayey sand.   | Pot, FC          | 40-410  |
| 9605  | Fill  | 9606    | 0.76      | 0.18      | Primary Fill. Light bluish grey, sandy clay.   |                  |         |
| 9606  | Cut   |         | 2.2       | 0.54      | Ditch  |                  |         |
| 9607  | Cut   |         | 0.28      | 0.2       | Ditch  |                  |         |
| 9608  | Fill  | 9607    | 0.28      | 0.2       | Secondary Fill. Light greyish brown, sandy clay.   |                  |         |
| 9609  | Layer |         |           |           | Natural  |                  |         |
| 9610  | Cut   |         | 0.25      | 0.1       | Cremation Cut  |                  |         |
| 9611  | Fill  | 9610    | 0.18      | 0.02      | Cremation Container  | Pot              | 40-410  |
| 9612  | Fill  | 9610    | 0.18      | 0.07      | Cremation Deposit. Dark grey black, charcoal.  | Pot, Sample <9>  | LIA-Rom |
| 9613  | Fill  | 9610    | 0.25      | 0.04      | Deliberate Backfill. Dark black grey, silty sand.  | Pot, Sample <10> | LIA-Rom |
| 9614  | Group |         |           |           | Cremation Cut  |                  |         |
| <b>Trench 97</b>  |       |         |           |           |  |                  |         |



| General description   |       |         |           |           |   | Orientation    | NE-SW  |
|---|-------|---------|-----------|-----------|---|----------------|--------|
| Trench contained a layer of colluvium. Consisted of ploughsoil and subsoil overlying sand and gravel geology. |       |         |           |           |   | Length (m)     | 30     |
|   |       |         |           |           |   | Width (m)      | 2      |
|   |       |         |           |           |   | Avg. depth (m) | 0.4    |
| Context No.   | Type  | Fill Of | Width (m) | Depth (m) | Description                                   | Finds          | Date   |
| 9700  | Layer |         |           | 0.3       | Ploughsoil. Mid grey brown, clayey silt.      | Flint, 1BF     |        |
| 9701  | Layer |         |           | 0.1       | Natural. Mid brown yellow, sandy clay.        |                |        |
| 9702  | Layer |         |           | 0.14      | Subsoil. Brown grey, clayey silt.             |                |        |
| 9703  | Layer |         | 9         | 0.35      | Colluvial Layer. Mid brown grey, clayey silt. | Pot, AB        | 40-410 |

### Trench 98

| General description  |       |         |           |           |  | Orientation                            | NE-SW  |
|--|-------|---------|-----------|-----------|--|--|--------|
| Trench revealed complex archaeology. Two ditches, three linear features, one ditch terminus, three pits and a few not identified features were present. Trench consisted of ploughsoil overlying natural geology of sand and gravel. |       |         |           |           |  | Length (m)                             | 30     |
|  |       |         |           |           |  | Width (m)                              | 2      |
|  |       |         |           |           |  | Avg. depth (m)                         | 0.4    |
| Context No.  | Type  | Fill Of | Width (m) | Depth (m) | Description  | Finds                                  | Date   |
| 9800   | Layer |         |           | 0.3       | Ploughsoil. Mid grey brown clayey silt.                      |  |        |
| 9801   | Layer |         |           | 0.1       | Natural. Mid brown orange, sandy gravel.                     |  |        |
| 9802   | Cut   |         | 0.4       | 0.54      | Ditch  |  |        |
| 9803   | Fill  | 9802    | 0.6       | 0.12      | Secondary Fill. Dark grey, silty sand.                       |  |        |
| 9804   | Fill  | 9802    | 0.5       | 0.16      | Secondary Fill. Mid grey, silty sand.                        |  |        |
| 9805   | Fill  | 9802    | 0.4       | 0.24      | Secondary Fill. Mid grey, gravelly sand.                     |  |        |
| 9806   | Cut   |         | 1.52      | 0.62      | Ditch  |  |        |
| 9807   | Fill  | 9806    | 1.2       | 0.1       | Secondary Fill. Dark grey, silty clayey sandy gravel.        |  |        |
| 9808   | Fill  | 9806    | 1.34      | 0.16      | Secondary Fill. Mid grey, silty sandy clayey gravel.         | Pot, FC                                | 40-410 |
| 9809   | Fill  | 9806    | 0.4       | 0.34      | Secondary Fill. Mid grey, silty, gravelly sand.              | Pot                                    | 40-410 |
| 9810   | Fill  | 9806    | 1.1       | 0.16      | Deliberate Backfill. Dark grey, silty gravelly clayey sand.  | Pot                                    | 40-410 |
| 9811   | Fill  | 9806    | 0.78      | 0.12      | Deliberate Backfill. Light grey yellow, silty gravelly sand. | Pot                                    | 40-410 |
| 9812   | Fill  | 9806    | 0.88      | 0.2       | Deliberate Backfill. Dark grey black, silt gravelly sand.    | Flint, Pot, FC, CBM (RB), Conglomerate | 40-410 |
| 9813   | Cut   |         | 0.2       | 0.18      | Modern   |  |        |
| 9814   | Fill  | 9813    | 0.04      | 0.04      | Deliberate Backfill. Light grey, sandy gravel.               |  |        |
| 9815   | Fill  | 9813    | 0.16      | 0.14      | Deliberate Backfill. Dark, grey brown, silty sand.           | CBM                                    |        |
| 9816   | Layer |         | 1.5       | 0.12      | Other Layer. Mid-grey, silty sand and silty gravelly sand.   | Flints x 3, Pot                        | MIA    |
| 9817   | Cut   |         | 0.3       | 0.22      | Pit  |  |        |

|      |                     |      |      |      |   |         |        |
|------|---------------------|------|------|------|---|---------|--------|
| 9818 | Fill                | 9817 | 0.3  | 0.22 | Secondary Fill. Mid grey, silty gravelly sand.        |         |        |
| 9819 | Cut                 |      | 0.7  | 0.26 | Other Cut   |         |        |
| 9820 | Fill                | 9819 | 0.7  | 0.26 | Secondary Fill. Mid grey, silty gravelly sand.        |         |        |
| 9821 | Cut                 |      | 0.84 | 0.41 | Ditch   |         |        |
| 9822 | Fill                | 9821 | 0.56 | 0.12 | Secondary Fill. Light grey, silty sand.               |         |        |
| 9823 | Fill                | 9821 | 0.7  | 0.16 | Secondary Fill. Dark grey, soft silty gravelly sand.  |         |        |
| 9824 | Fill                | 9821 | 0.84 | 0.16 | Secondary Fill. Mid brown grey, silty sand.           |         |        |
| 9825 | Cut                 |      | 0.2  | 0.4  | Modern. Land drain.                                   |         |        |
| 9826 | Fill                | 9825 | 0.2  | 0.4  | Deliberate Backfill. Mid grey brown, sand.            |         |        |
| 9827 | Fill                | 9828 |      | 0.4  | Deliberate Backfill. Dark grey, silty gravelly sand.  | Pot     | 40-410 |
| 9828 | Cut                 |      |      | 0.4  | Ditch. Same as [9806]                                 |         |        |
| 9829 | Unexcavated feature |      | 0.2  |      | Modern. Grey brown, coarse sand. Possible mole drain. | Fe lump |        |
| 9830 | Unexcavated feature |      | 2    |      | Pit. Mid grey, silty sand. Uncertain feature type.    |         |        |
| 9831 | Unexcavated feature |      |      |      | Pit. Mid grey, silty sand.                            |         |        |

#### Trench 99

| General description  |       |         |           |           |   | Orientation                | NW-SE  |
|--|-------|---------|-----------|-----------|---|----------------------------|--------|
| Trench revealed four ditches and one gully. Consisted of ploughsoil overlying natural geology of sandy gravel. |       |         |           |           |   | Length (m)                 | 30     |
|  |       |         |           |           |   | Width (m)                  | 2      |
|  |       |         |           |           |   | Avg. depth (m)             | 0.48   |
| Context No.  | Type  | Fill Of | Width (m) | Depth (m) | Description   | Finds                      | Date   |
| 9900   | Layer |         |           | 0.3       | Ploughsoil. Mid grey brown, clayey silt.  |                            |        |
| 9901   | Layer |         |           | 0.18      | Natural. Mid brown yellow, sandy clay mixed with a light brown grey sandy gravel. |                            |        |
| 9902   | Cut   |         | 1.7       | 0.6       | Ditch   |                            |        |
| 9903   | Fill  | 9902    | 1.2       | 0.29      | Secondary Fill. Mid grey blue, silty sand.  | Flint, Pot, AB, Sample <3> | 40-410 |
| 9904   | Cut   |         | 1.66      | 0.6       | Ditch   |                            |        |
| 9905   | Cut   |         | 3.1       | 0.6       | Ditch   |                            |        |
| 9906   | Cut   |         | 0.26      | 0.12      | Ditch   |                            |        |
| 9907   | Fill  | 9904    | 1.8       | 0.45      | Secondary Fill. Mid grey brown, silty sand.                                       |                            |        |
| 9908   | Fill  | 9905    | 2.08      | 0.06      | Tertiary Fill. Mid brown grey, silty sand.  |                            |        |
| 9909   | Fill  | 9905    | 2.38      | 0.1       | Secondary Fill. Dark brown grey, silty sand.                                      | Pot, AB                    | 40-410 |
| 9910   | Fill  | 9905    | 3.2       | 0.44      | Secondary Fill. Mid brown grey, silty sand.                                       | Flint, Pot, AB             | LBA?   |
| 9911   | Fill  | 9905    | 2.75      | 0.3       | Secondary Fill. Mid grey brown, silty sand.                                       |                            |        |
| 9912   | Fill  | 9906    | 0.26      | 0.11      | Secondary Fill. Mid brown grey, silty sand.                                       |                            |        |
| 9913   | Cut   |         | 2.6       | 0.6       | Ditch   |                            |        |
| 9914   | Fill  | 9913    | 2         | 0.6       | Secondary Fill. Mid yellow grey, clayey silt.                                     |                            |        |

| 9915   | Fill  | 9902    | 2.6       | 0.6       | Secondary Fill. Mid grey blue, silty sand.                  |                |        |
|--|-------|---------|-----------|-----------|---|----------------|--------|
| <b>Trench 100</b>  |       |         |           |           |   |                |        |
| General description  |       |         |           |           |   | Orientation    | SW-NE  |
| Trench revealed a series of intercutting ditches and another possible ditch. Consisted of ploughsoil overlying sand and gravel geology.                |       |         |           |           |   | Length (m)     | 30     |
|  |       |         |           |           |   | Width (m)      | 2      |
|  |       |         |           |           |   | Avg. depth (m) | 0.3    |
| Context No.  | Type  | Fill Of | Width (m) | Depth (m) | Description   | Finds          | Date   |
| 10000  | Layer |         |           | 0.28      | Ploughsoil. Mid grey brown, clayey silt.                    |                |        |
| 10001  | Layer |         |           | 0.12      | Subsoil. Light grey brown, clayey silt.                     |                |        |
| 10002  | Layer |         |           |           | Natural. Light brown orange, gravelly silty clay.           |                |        |
| 10003  | Cut   |         | 6.5       | 0.4       | Other Cut   |                |        |
| 10004  | Fill  | 10003   | 2.6       | 0.18      | Secondary Fill. Mid grey, silty sand.                       |                |        |
| 10005  | Fill  | 10003   | 2.44      | 0.1       | Secondary Fill. Mid grey, silty sand.                       |                |        |
| 10006  | Fill  | 10003   | 6.5       | 0.4       | Secondary Fill. Mid brown grey, silty sand.                 | Pot            | 40-410 |
| 10007  | Cut   |         | 1.7       | 0.26      | Ditch   |                |        |
| 10008  | Fill  | 10007   | 1.7       | 0.26      | Secondary Fill. Mid brown grey, sandy silt                  | Pot            | 40-410 |
| 10009  | Cut   |         | 1.12      | 0.3       | Ditch   |                |        |
| 10010  | Fill  | 10009   | 1.12      | 0.3       | Secondary Fill. Mid grey, silty sand                        | Pot, AB        | 40-410 |
| 10011  | Cut   |         | 0.9       | 0.34      | Ditch   |                |        |
| 10012  | Fill  | 10011   | 0.9       | 0.34      | Secondary Fill. Light brown grey, silty sand.               |                |        |
| 10013  | Cut   |         | 0.82      | 0.52      | Pit   |                |        |
| 10014  | Fill  | 10013   | 0.82      | 0.52      | Secondary Fill. Mid grey brown, silty sand.                 | Pot            | 40-410 |
| 10015  | Cut   |         | 0.62      | 0.2       | Ditch   |                |        |
| 10016  | Fill  | 10015   | 0.62      | 0.2       | Secondary Fill. Mid brown grey, silty sand.                 | AB             |        |
| 10017  | Cut   |         | 1.88      | 0.22      | Natural Feature   |                |        |
| 10018  | Fill  | 10017   | 1.88      | 0.22      | Secondary Fill. Mid brown grey, silty gravelly coarse sand. |                |        |
| 10019  | Cut   |         | 0.6       | 0.2       | Tree Throw  |                |        |
| 10020  | Fill  | 10019   | 0.6       | 0.2       | Secondary Fill. Light grey and light brown, silty sand.     |                |        |
| <b>Trench 101</b>  |       |         |           |           |   |                |        |
| General description  |       |         |           |           |   | Orientation    | NW-SE  |
| Trench revealed one E-W ditch, a natural feature, and a modern pit. Trench consisted of ploughsoil overlying natural geology of silty sand with gravel |       |         |           |           |   | Length (m)     | 30     |
|  |       |         |           |           |   | Width (m)      | 2      |
|  |       |         |           |           |   | Avg. depth (m) | 0.47   |
| Context No.  | Type  | Fill Of | Width (m) | Depth (m) | Description   | Finds          | Date   |
| 10100  | Layer |         |           | 0.2       | Ploughsoil. Mid grey brown, clayey silt.                    |                |        |

|       |                     |       |      |      |  |                         |         |
|-------|---------------------|-------|------|------|--|-------------------------|---------|
| 10101 | Layer               |       |      | 0.17 | Natural. Mid orange yellow, gravelly sand.                                 |                         |         |
| 10102 | Cut                 |       | 2.4  | 0.66 | Ditch  |                         |         |
| 10103 | Fill                | 10102 | 2.4  | 0.42 | Primary Fill. Mid white grey with small yellow patches, silty sand.        | Pot                     | 40-410  |
| 10104 | Cut                 |       | 1.52 | 0.52 | Ditch  |                         |         |
| 10105 | Fill                | 10104 | 1.52 | 0.34 | Primary Fill. Mid brown grey, silty sand.                                  | Pot, Brick (RB), FC, AB | 100-410 |
| 10106 | Fill                | 10104 | 1.32 | 0.3  | Secondary Fill. Light white grey, silty sand.                              |                         |         |
| 10107 | Cut                 |       | 0.72 | 0.54 | Pit. Possibly modern.  |                         |         |
| 10108 | Fill                | 10107 | 0.72 | 0.54 | Deliberate Backfill. Mid brown grey mixed with natural lenses, silty sand. |                         |         |
| 10109 | Unexcavated feature |       | 2.28 |      | Pit. Mid grey brown sandy silt with charcoal lenses.                       |                         |         |

### Trench 102

#### General description

Trench revealed a single ditch. Consisted of ploughsoil overlying sand and gravel geology.

|                |       |
|----------------|-------|
| Orientation    | NW-SE |
| Length (m)     | 30    |
| Width (m)      | 2     |
| Avg. depth (m) | 0.48  |

| Context No. | Type  | Fill Of | Width (m) | Depth (m) | Description   | Finds   | Date   |
|-------------|-------|---------|-----------|-----------|---|---------|--------|
| 10200       | Layer |         |           | 0.3       | Ploughsoil. Mid grey brown, clayey silt.                    |         |        |
| 10201       | Layer |         |           | 0.18      | Natural. Mid brown yellow, sand and mid yellow brown, clay. |         |        |
| 10202       | Cut   |         | 2.8       | 0.71      | Ditch   |         |        |
| 10203       | Fill  | 10202   | 2.33      | 0.37      | Primary Fill. Mid orange grey, silty clay.                  | Pot, AB | LIA-ER |
| 10204       | Fill  | 10202   | 1.39      | 0.16      | Secondary Fill. Dark grey brown, silty clay.                | Pot, AB | 40-410 |
| 10205       | Fill  | 10202   | 2.8       | 0.18      | Secondary Fill. Mid grey brown, silty clay.                 | Pot     | 40-410 |

### Trench 103

#### General description

Trench revealed one pit and five ditches. Consisted of ploughsoil and subsoil overlying natural geology of sandy gravels.

|                |     |
|----------------|-----|
| Orientation    | E-W |
| Length (m)     | 30  |
| Width (m)      | 2.2 |
| Avg. depth (m) | 0.4 |

| Context No. | Type  | Fill Of | Width (m) | Depth (m) | Description  | Finds | Date   |
|-------------|-------|---------|-----------|-----------|--|-------|--------|
| 10300       | Layer |         |           | 0.29      | Ploughsoil. Dark grey brown, sandy silt.                           |       |        |
| 10301       | Layer |         |           | 0.11      | Subsoil. Mid grey brown, silty gravel.                             |       |        |
| 10302       | Layer |         |           |           | Natural. Mid orange brown and light yellow brown, sand and gravel. |       |        |
| 10303       | Cut   |         | 0.98      | 0.36      | Ditch  |       |        |
| 10304       | Fill  | 10303   | 0.98      | 0.14      | Primary Fill. Light brown grey, silty sand.                        |       |        |
| 10305       | Fill  | 10303   | 0.64      | 0.25      | Secondary Fill. Mid grey brown, silty sand.                        | Pot   | 40-410 |

|       |      |       |      |      |   |     |         |
|-------|------|-------|------|------|---|-----|---------|
| 10306 | Cut  |       | 1.9  | 0.6  | Ditch   |     |         |
| 10307 | Fill | 10306 | 1.8  | 0.3  | Primary Fill. Light brown grey, silty sand.       |     |         |
| 10308 | Fill | 10306 | 1.9  | 0.3  | Secondary Fill. Dark grey, brown sandy silt.      | Pot | 40-410  |
| 10309 | Cut  |       | 1.48 | 0.51 | Ditch   |     |         |
| 10310 | Fill | 10309 | 0.93 | 0.15 | Primary Fill. Light grey brown, silty sand.       | Pot | 120-250 |
| 10311 | Fill | 10309 | 1.14 | 0.28 | Deliberate Backfill. Dark grey brown, sandy silt. | Pot | 200-250 |
| 10312 | Fill | 10309 | 1.16 | 0.23 | Secondary Fill. Mid grey brown, sandy silt.       | Pot | 100-150 |
| 10313 | Cut  |       | 0.6  | 0.13 | Ditch   |     |         |
| 10314 | Fill | 10313 | 0.6  | 0.13 | Secondary Fill. Mid orange brown, silty sand.     | Pot | 40-410  |
| 10315 | Cut  |       | 1    | 0.36 | Pit   |     |         |
| 10316 | Fill | 10315 | 1    | 0.36 | Secondary Fill. Dark grey brown, sandy silt.      |     |         |
| 10317 | Cut  |       | 0.56 | 0.26 | Ditch   |     |         |
| 10318 | Fill | 10317 | 0.56 | 0.26 | Secondary Fill. Mid grey brown, sandy silt.       |     |         |

#### Trench 104

| General description  |       |         |           |           |  | Orientation              | E-W  |
|--|-------|---------|-----------|-----------|--|--------------------------|--|
| Trench revealed one N-S running ditch and area of remnant topsoil. Consisted of ploughsoil overlying sandy clay geology. |       |         |           |           |  | Length (m)               | 30   |
|  |       |         |           |           |  | Width (m)                | 2.2  |
|  |       |         |           |           |  | Avg. depth (m)           | 0.5  |
| Context No.  | Type  | Fill Of | Width (m) | Depth (m) | Description  | Finds                    | Date   |
| 10400  | Layer |         |           | 0.34      | Ploughsoil. Mid orange grey sandy silt with occasional rounded pebbles |                          |  |
| 10401  | Layer |         |           |           | Natural. Mid grey orange, sand.  |                          |  |
| 10402  | Layer |         |           |           | Remnant Topsoil. Mid Brownish grey                                     | Fe lump.                 |  |
| 10403  | Cut   |         | 1.1       | 0.46      | Ditch  |                          |  |
| 10404  | Fill  | 10403   | 1.1       | 0.46      | Primary Fill. Mid brown grey, clayey sand.                             | Brick and iron mower bar | Later C19 <sup>th</sup> or C20 <sup>th</sup> |

#### Trench 105

| General description  |       |         |           |           |   | Orientation    | NW-SE |
|--|-------|---------|-----------|-----------|---|----------------|-------|
| Trench revealed four ditches running NW-SE, and possible additional linear (unexcavated). Consisted of ploughsoil overlying sand and gravel. |       |         |           |           |   | Length (m)     | 30    |
|  |       |         |           |           |   | Width (m)      | 2.2   |
|  |       |         |           |           |   | Avg. depth (m) | 0.5   |
| Context No.  | Type  | Fill Of | Width (m) | Depth (m) | Description   | Finds          | Date  |
| 10500  | Layer |         |           | 0.45      | Ploughsoil. Dark brown grey, silty clay.  |                |       |
| 10501  | Layer |         |           |           | Natural. Orange sandy gravels with occasional patches of yellowish orange clay. |                |       |
| 10502  | Cut   |         | 1.23      | 0.28      | Ditch   |                |       |

|       |                     |       |      |      |   |   |         |
|-------|---------------------|-------|------|------|---|---|---------|
| 10503 | Fill                | 10502 | 1.23 | 0.28 | Primary Fill. Dark grey brown, silty sand.      |   |         |
| 10504 | Cut                 |       | 1.67 | 0.28 | Ditch   |   |         |
| 10505 | Fill                | 10504 | 1.87 | 0.28 | Primary Fill. Dark grey brown, silty sand.      |   |         |
| 10506 | Cut                 |       | 1.58 | 0.59 | Ditch   |   |         |
| 10507 | Fill                | 10506 | 1.58 | 0.59 | Primary Fill. Mid grey brown, sandy silt.       | Flints x 3,<br>Pot, Fe nail,<br>Sample <13> | 250-410 |
| 10508 | Cut                 |       | 1.35 | 0.23 | Ditch   |   |         |
| 10509 | Fill                | 10508 | 1.35 | 0.23 | Primary Fill. Mid grey brown, sandy silt.       | Pot   | 40-410  |
| 10510 | Layer               |       |      |      | Other Layer. Natural deposit-burrowing possible |   |         |
| 10511 | Layer               |       |      |      | Other Layer. Natural deposit-bioturbation       |   |         |
| 10512 | Unexcavated feature |       | 3    |      | Ditch   |   |         |

### Trench 106

|  |       |         |           |           |  |                |      |
|--|-------|---------|-----------|-----------|--|----------------|------|
| General description  |       |         |           |           |  | Orientation    | N-S  |
| Trench devoid of archaeology. Trench consisted of ploughsoil overlying natural Sandy Gravel. |       |         |           |           |  | Length (m)     | 30   |
|  |       |         |           |           |  | Width (m)      | 2.2  |
|  |       |         |           |           |  | Avg. depth (m) | 0.33 |
| Context No.  | Type  | Fill Of | Width (m) | Depth (m) | Description                                  | Finds          | Date |
| 10600  | Layer |         |           | 0.26      | Ploughsoil. Dark grey brown, sandy silt.     |                |      |
| 10601  | Layer |         |           |           | Natural. Mixed yellow, orange gravelly sand. |                |      |
| 10602  | Layer |         |           |           | Natural. Gravel                              |                |      |

### Trench 107

|   |       |         |           |           |  |                |       |
|---|-------|---------|-----------|-----------|--|----------------|-------|
| General description   |       |         |           |           |  | Orientation    | NW-SE |
| Trench devoid of archaeology. Consisted of ploughsoil overlying natural geology of silty clay with gravels. |       |         |           |           |  | Length (m)     | 30    |
|   |       |         |           |           |  | Width (m)      | 2     |
|   |       |         |           |           |  | Avg. depth (m) | 0.5   |
| Context No.   | Type  | Fill Of | Width (m) | Depth (m) | Description  | Finds          | Date  |
| 10700   | Layer |         |           | 0.34      | Ploughsoil. Mid grey brown, silty clay.  |                |       |
| 10701   | Layer |         |           |           | Natural. Mid orange grey, silty clay with gravels and patches of mid orange grey silty sand. |                |       |

### Trench 108

|   |      |         |           |           |             |                |       |
|---|------|---------|-----------|-----------|-------------|----------------|-------|
| General description   |      |         |           |           |             | Orientation    | NE-SW |
| Trench devoid of archaeology. Consisted of ploughsoil overlying natural geology of silty clay with gravels. |      |         |           |           |             | Length (m)     | 30    |
|   |      |         |           |           |             | Width (m)      | 2     |
|   |      |         |           |           |             | Avg. depth (m) | 0.37  |
| Context No.   | Type | Fill Of | Width (m) | Depth (m) | Description | Finds          | Date  |

|       |       |  |  |      |   |  |  |
|-------|-------|--|--|------|---|--|--|
| 10800 | Layer |  |  | 0.27 | Ploughsoil. Mid grey brown, silty clay.             |  |  |
| 10801 | Layer |  |  |      | Natural. Mid orange brown, silty clay with gravels. |  |  |
| 10802 | Void  |  |  |      |   |  |  |
| 10803 | Void  |  |  |      |   |  |  |
| 10804 | Void  |  |  |      |   |  |  |
| 10805 | Void  |  |  |      |   |  |  |

### Trench 109

| General description  |                     |         |           |           |  | Orientation    | NW-SE |
|--|---------------------|---------|-----------|-----------|--|----------------|-------|
| Trench revealed one ditch. Consisted of ploughsoil and subsoil overlying natural geology of silty clay with gravels. |                     |         |           |           |  | Length (m)     | 30    |
|  |                     |         |           |           |  | Width (m)      | 2     |
|  |                     |         |           |           |  | Avg. depth (m) | 0.7   |
| Context No.  | Type                | Fill Of | Width (m) | Depth (m) | Description                                | Finds          | Date  |
| 10900  | Layer               |         |           | 0.32      | Ploughsoil. Mid grey brown, silty clay     | Pot            | PMed  |
| 10901  | Layer               |         |           | 0.27      | Subsoil. Mid yellow brown, silty clay      |                |       |
| 10902  | Layer               |         |           |           | Natural. Mid yellow brown, silty clay      |                |       |
| 10903  | Cut                 |         | 0.4       | 0.16      | Ditch                                      |                |       |
| 10904  | Fill                | 10903   | 0.4       | 0.16      | Primary Fill. Mid grey yellow, silty clay. |                |       |
| 10905  | Unexcavated feature |         | 0.5       |           | Ditch. Flooded trench                      |                |       |
| 10906  | Unexcavated feature |         | 0.75      |           | Ditch. Flooded trench                      |                |       |

### Trench 110

| General description   |       |         |           |           |   | Orientation    | NE-SW |
|---|-------|---------|-----------|-----------|---|----------------|-------|
| Trench devoid of archaeology. Consisted of ploughsoil and subsoil overlying natural geology of silty clay with gravels. |       |         |           |           |   | Length (m)     | 30    |
|   |       |         |           |           |   | Width (m)      | 2     |
|   |       |         |           |           |   | Avg. depth (m) | 0.72  |
| Context No.   | Type  | Fill Of | Width (m) | Depth (m) | Description                                       | Finds          | Date  |
| 11000   | Layer |         |           | 0.27      | Ploughsoil. Mid grey brown, silty clay            |                |       |
| 11001   | Layer |         |           | 0.27      | Subsoil. Mid yellow grey, silty clay              |                |       |
| 11002   | Layer |         |           |           | Natural. Mid yellow grey, silty clay with gravels |                |       |

### Trench 111

| General description  |      |         |           |           |             | Orientation    | NW-SE |
|--|------|---------|-----------|-----------|-------------|----------------|-------|
| Trench contained one deposit, very difficult to distinguish from natural, containing archaeological material. Otherwise consisted of ploughsoil and subsoil overlying natural geology of silty clay. Revealed one field drain. |      |         |           |           |             | Length (m)     | 30    |
|  |      |         |           |           |             | Width (m)      | 2     |
|  |      |         |           |           |             | Avg. depth (m) | 0.72  |
| Context No.  | Type | Fill Of | Width (m) | Depth (m) | Description | Finds          | Date  |

|  |       |         |           |           |  |                |       |
|--|-------|---------|-----------|-----------|--|----------------|-------|
| 11100  | Layer |         |           | 0.32      | Ploughsoil. Mid grey brown, silty clay                                 |                |       |
| 11101  | Layer |         |           | 0.23      | Subsoil. Mid yellow brown, silty clay                                  |                |       |
| 11102  | Layer |         |           |           | Natural. Mid yellow brown, silty clay                                  |                |       |
| 11103  | Layer |         | 5         | 0.25      | Other Layer. Light grey brown mottled with orange patches, sandy clay. | Flint, Pot, AB | LBA?  |
| <b>Trench 112</b>  |       |         |           |           |  |                |       |
| General description  |       |         |           |           |  | Orientation    | NE-SW |
| Trench devoid of archaeology. Consisted of ploughsoil and subsoil overlying natural geology of silty clay. Revealed one field drain.       |       |         |           |           |  | Length (m)     | 30    |
|  |       |         |           |           |  | Width (m)      | 2     |
|  |       |         |           |           |  | Avg. depth (m) | 0.54  |
| Context No.  | Type  | Fill Of | Width (m) | Depth (m) | Description  | Finds          | Date  |
| 11200  | Layer |         |           | 0.24      | Ploughsoil. Mid grey brown, silty clay.                                |                |       |
| 11201  | Layer |         |           | 0.2       | Subsoil. Mid yellow brown, silty clay.                                 |                |       |
| 11202  | Layer |         |           |           | Natural. Mid yellow brown, silty clay.                                 |                |       |
| <b>Trench 113</b>  |       |         |           |           |  |                |       |
| General description  |       |         |           |           |  | Orientation    | NE-SW |
| Trench devoid of archaeology. Consisted of ploughsoil overlying natural geology of silty clay with gravels.                                |       |         |           |           |  | Length (m)     | 30    |
|  |       |         |           |           |  | Width (m)      | 2     |
|  |       |         |           |           |  | Avg. depth (m) | 0.46  |
| Context No.  | Type  | Fill Of | Width (m) | Depth (m) | Description  | Finds          | Date  |
| 11300  | Layer |         |           | 0.28      | Ploughsoil. Mid grey brown, silty clay.                                |                |       |
| 11301  | Layer |         |           |           | Natural. Mid orange grey, silty clay with gravels                      |                |       |
| <b>Trench 114</b>  |       |         |           |           |  |                |       |
| General description  |       |         |           |           |  | Orientation    | NW-SE |
| Trench devoid of archaeology. Consisted of ploughsoil overlying natural geology of silty clay with gravels.                                |       |         |           |           |  | Length (m)     | 30    |
|  |       |         |           |           |  | Width (m)      | 2     |
|  |       |         |           |           |  | Avg. depth (m) | 0.43  |
| Context No.  | Type  | Fill Of | Width (m) | Depth (m) | Description  | Finds          | Date  |
| 11400  | Layer |         |           | 0.32      | Ploughsoil. Mid grey brown, silty clay.                                |                |       |
| 11401  | Layer |         |           |           | Natural. Mid orange brown, silty clay with gravels.                    |                |       |
| <b>Trench 115</b>  |       |         |           |           |  |                |       |
| General description  |       |         |           |           |  | Orientation    | NE-SW |
| Trench devoid of archaeology. Consisted of ploughsoil overlying natural geology of silty clay with gravels. Trench revealed 2 land drains. |       |         |           |           |  | Length (m)     | 30    |
|  |       |         |           |           |  | Width (m)      | 2     |



|  |                     |         |           |           |  | Avg. depth (m)             | 0.44   |
|--|---------------------|---------|-----------|-----------|--|----------------------------|--------|
| Context No.  | Type                | Fill Of | Width (m) | Depth (m) | Description  | Finds                      | Date   |
| 11500  | Layer               |         |           | 0.19      | Ploughsoil. Mid grey brown, silty clay.                                  |                            |        |
| 11501  | Layer               |         |           |           | Natural. Mid yellow brown, silty clay with patches of yellow grey gravel |                            |        |
| <b>Trench 116</b>  |                     |         |           |           |  |                            |        |
| General description  |                     |         |           |           |  | Orientation                | NW-SE  |
| Trench revealed three linears, of which one was left unexcavated. Consisted of ploughsoil and subsoil overlying sandy clay.                                |                     |         |           |           |  | Length (m)                 | 30     |
|  |                     |         |           |           |  | Width (m)                  | 2      |
|  |                     |         |           |           |  | Avg. depth (m)             | 0.7    |
| Context No.  | Type                | Fill Of | Width (m) | Depth (m) | Description  | Finds                      | Date   |
| 11600  | Layer               |         |           | 0.26      | Ploughsoil. Mid grey brown, silty sand.                                  | Flint, Farthing George III | Modern |
| 11601  | Layer               |         |           | 0.39      | Subsoil. Mid yellow grey, silty clay.                                    |                            |        |
| 11602  | Layer               |         |           |           | Natural. Light yellow grey, silty clay.                                  |                            |        |
| 11603  | Cut                 |         | 0.56      | 0.32 +    | Ditch, vertical sides, not bottomed.                                     |                            |        |
| 11604  | Fill                |         | 0.56      | 0.32      | Secondary Fill. Mid orange grey, silty clay.                             | Pot                        | 40-410 |
| 11605  | Cut                 |         | 0.65      | 0.22      | Ditch, vertical sides, not bottomed.                                     |                            |        |
| 11606  | Fill                | 11605   | 0.65      | 0.22      | Secondary Fill. Mid orange grey, silty clay.                             |                            |        |
| 11607  | Unexcavated feature |         | 0.73      |           | Ditch. Ditch. Mid orange, grey silty clay fill                           |                            |        |
| <b>Trench 117</b>  |                     |         |           |           |  |                            |        |
| General description  |                     |         |           |           |  | Orientation                | E-W    |
| Trench revealed no archaeology. Two land drains cut across it. Ploughsoil and subsoil onto sandy clay geology.   |                     |         |           |           |  | Length (m)                 | 30     |
|  |                     |         |           |           |  | Width (m)                  | 2      |
|  |                     |         |           |           |  | Avg. depth (m)             | 0.62   |
| Context No.  | Type                | Fill Of | Width (m) | Depth (m) | Description  | Finds                      | Date   |
| 11700  | Layer               |         |           | 0.28      | Ploughsoil. Mid grey brown, clayey silt.                                 |                            |        |
| 11701  | Layer               |         |           | 0.33      | Subsoil. Light yellow grey, silty clay.                                  |                            |        |
| 11702  | Layer               |         |           |           | Natural. Light grey yellow, sandy clay.                                  |                            |        |
| <b>Trench 118</b>  |                     |         |           |           |  |                            |        |
| General description  |                     |         |           |           |  | Orientation                | NW-SE  |
| Trench revealed three linears and an area of modern bioturbation. Consists of ploughsoil and subsoil overlying natural geology of silty clay with gravels. |                     |         |           |           |  | Length (m)                 | 30     |
|  |                     |         |           |           |  | Width (m)                  | 2      |
|  |                     |         |           |           |  | Avg. depth (m)             | 0.4    |
| Context No.  | Type                | Fill Of | Width (m) | Depth (m) | Description  | Finds                      | Date   |

|       |                     |       |      |      |  |         |         |
|-------|---------------------|-------|------|------|--|---------|---------|
| 11800 | Layer               |       |      | 0.28 | Ploughsoil. Mid grey brown, silty clay                         |         |         |
| 11801 | Layer               |       |      |      | Natural. Mid orange brown, silty clay with gravels             |         |         |
| 11802 | Cut                 |       | 0.4  | 0.2  | Ditch  |         |         |
| 11803 | Fill                | 11802 | 0.4  | 0.2  | Primary Fill. Mid orange brown, sandy silt.                    |         |         |
| 11804 | Fill                | 11802 | 0.46 | 0.2  | Secondary Fill. Mid grey brown, sandy silt.                    |         |         |
| 11805 | Layer               |       |      | 0.1  | Subsoil. Mid yellow grey, silty clay.                          |         |         |
| 11806 | Layer               |       | 0.6  | 0.09 | Remnant Topsoil. Dark grey, silty clay.                        |         |         |
| 11807 | Cut                 |       | 0.98 | 0.28 | Ditch  |         |         |
| 11808 | Fill                | 11807 | 0.98 | 0.28 | Secondary Fill. Mid brown yellow, sand.                        |         |         |
| 11809 | Cut                 |       | 1.64 | 0.54 | Ditch  |         |         |
| 11810 | Fill                | 11809 | 0.28 | 0.48 | Primary Fill. Dark red orange, sandy clay.                     |         |         |
| 11811 | Fill                | 11809 | 1.48 | 0.32 | Secondary Fill. Mottled grey and mid brown orange, sandy clay. | Pot, AB | MIA-LIA |
| 11812 | Unexcavated feature |       | 2.17 |      | Ditch. Mid orange brown, sandy silt.                           |         |         |

#### Trench 119

| General description   |       |         |           |           |  | Orientation    | NE-SW  |
|---|-------|---------|-----------|-----------|--|----------------|--------|
| Trench contains one ditch. Consists of ploughsoil overlying natural geology of sandy clay with gravels. |       |         |           |           |  | Length (m)     | 30     |
|   |       |         |           |           |  | Width (m)      | 2      |
|   |       |         |           |           |  | Avg. depth (m) | 0.37   |
| Context No.   | Type  | Fill Of | Width (m) | Depth (m) | Description  | Finds          | Date   |
| 11900   | Layer |         |           | 0.26      | Ploughsoil. Mid grey brown, silty clay.            | Flint          |        |
| 11901   | Layer |         |           |           | Natural. Mid orange brown, silty clay with gravels |                |        |
| 11902   | Cut   |         | 1.36      | 0.6       | Ditch  |                |        |
| 11903   | Fill  | 11902   |           | 0.32      | Secondary Fill. Mid red grey, sandy clay.          |                |        |
| 11904   | Fill  | 11902   |           | 0.42      | Secondary Fill. Light grey, sandy clay.            | Pot            | 40-410 |

#### Trench 120

| General description  |       |         |           |           |   | Orientation    | NW-SE |
|--|-------|---------|-----------|-----------|---|----------------|-------|
| Trench devoid of archaeology. Consists of ploughsoil overlying natural geology of silty clay with gravels. Trench revealed 1 land drain. |       |         |           |           |   | Length (m)     | 30    |
|  |       |         |           |           |   | Width (m)      | 2     |
|  |       |         |           |           |   | Avg. depth (m) | 0.39  |
| Context No.  | Type  | Fill Of | Width (m) | Depth (m) | Description   | Finds          | Date  |
| 12000  | Layer |         |           | 0.24      | Ploughsoil. Mid grey brown, silty clay                      |                |       |
| 12001  | Layer |         |           |           | Natural. Mid orange grey, silty clay with patches of gravel |                |       |

#### Trench 121

| General description  |       |         |           |           |   | Orientation    | NE-SW |
|--|-------|---------|-----------|-----------|---|----------------|-------|
| Trench devoid of archaeology. Consists of ploughsoil and subsoil overlying natural geology of silty clay with gravels. |       |         |           |           |   | Length (m)     | 27    |
|  |       |         |           |           |   | Width (m)      | 2     |
|  |       |         |           |           |   | Avg. depth (m) | 0.76  |
| Context No.  | Type  | Fill Of | Width (m) | Depth (m) | Description   | Finds          | Date  |
| 12100  | Layer |         |           | 0.29      | Ploughsoil. Mid grey brown, silty clay.                       |                |       |
| 12101  | Layer |         |           | 0.32      | Subsoil. Mid yellow brown, silty clay.                        |                |       |
| 12102  | Layer |         |           |           | Natural. Mid yellow brown, silty clay with occasional gravel. |                |       |

### Trench 122

| General description  |       |         |           |           |   | Orientation    | NW-SE |
|--|-------|---------|-----------|-----------|---|----------------|-------|
| Trench devoid of archaeology. Consists of ploughsoil and subsoil overlying natural geology of silty clay with gravels. |       |         |           |           |   | Length (m)     | 30    |
|  |       |         |           |           |   | Width (m)      | 2     |
|  |       |         |           |           |   | Avg. depth (m) | 0.52  |
| Context No.  | Type  | Fill Of | Width (m) | Depth (m) | Description   | Finds          | Date  |
| 12200  | Layer |         |           | 0.28      | Ploughsoil. Mid grey brown, silty clay.                                   |                |       |
| 12201  | Layer |         |           | 0.2       | Subsoil. Mid yellow brown, silty clay.                                    |                |       |
| 12202  | Layer |         |           |           | Natural. Mid yellow brown, silty clay with patches of yellow grey gravel. |                |       |

### Trench 123

| General description  |       |         |           |           |  | Orientation      | E-W  |
|--|-------|---------|-----------|-----------|--|------------------|------|
| Trench contained one modern pit. Trench consisted of plough soil and subsoil overlying natural geology of clay and sand. |       |         |           |           |  | Length (m)       | 30   |
|  |       |         |           |           |  | Width (m)        | 2    |
|  |       |         |           |           |  | Avg. depth (m)   | 0.52 |
| Context No.  | Type  | Fill Of | Width (m) | Depth (m) | Description                                  | Finds            | Date |
| 12300  | Layer |         |           | 0.21      | Ploughsoil. Dark grey, clayey silt.          |                  |      |
| 12301  | Layer |         |           | 0.22      | Subsoil. Light grey, silty clay.             |                  |      |
| 12302  | Layer |         |           |           | Natural. Grey yellow, sandy clay.            |                  |      |
| 12303  | Cut   |         | 2.5       | 0.5       | Pit. Modern pit                              |                  |      |
| 12304  | Fill  | 12303   | 2.5       | 0.5       | Primary Fill. Dark yellow brown, silty clay. | Brick & Tile, FC | Pmed |
| 12305  | Void  |         |           |           |  |                  |      |
| 12306  | Void  |         |           |           |  |                  |      |

### Trench 124

|  |  |  |  |  |  |             |         |
|--|--|--|--|--|--|-------------|---------|
| General description  |  |  |  |  |  | Orientation | ENE-WSW |
| Trench contains two intercutting ditches and a pit. A grey gravel spread was present at the western end. Ploughsoil overlying natural gravels. |  |  |  |  |  | Length (m)  | 30      |
|  |  |  |  |  |  | Width (m)   | 2.2     |

| Context No. | Type  | Fill Of | Width (m) | Depth (m) | Description  | Avg. depth (m) | Date |
|-------------|-------|---------|-----------|-----------|--|----------------|------|
| 12400       | Layer |         |           | 0.3       | Ploughsoil. Dark brown grey, silty clay.                                   | 0.44           |      |
| 12401       | Layer |         |           |           | Natural. Mixed orange, sandy gravels with light orange grey clayey gravels |                |      |
| 12402       | Cut   |         | 5.1       | 0.49      | Ditch  |                |      |
| 12403       | Fill  | 12402   | 3.19      | 0.4       | Secondary Fill. Mid grey brown, sandy silt.                                |                |      |
| 12404       | Cut   |         | 2.82      | 0.4       | Pit  |                |      |
| 12405       | Fill  | 12404   | 2.82      | 0.4       | Primary Fill. Mid grey brown, sandy silt.                                  |                |      |
| 12406       | Cut   |         | 0.8       | 0.34      | Ditch  |                |      |
| 12407       | Fill  | 12406   | 0.8       | 0.34      | Primary Fill. Mid grey brown, sandy silt.                                  |                |      |
| 12408       | Fill  | 12402   | 2.74      | 0.34      | Primary Fill. Mid grey brown sandy silt.                                   |                |      |

### Trench 125

#### General description

Trench revealed a possible linear. Consists of ploughsoil overlying natural geology of silty clay with gravels.

| Orientation    | NW-SE |
|----------------|-------|
| Length (m)     | 30    |
| Width (m)      | 2     |
| Avg. depth (m) | 0.41  |

| Context No. | Type  | Fill Of | Width (m) | Depth (m) | Description   | Finds | Date   |
|-------------|-------|---------|-----------|-----------|---|-------|--------|
| 12500       | Layer |         |           | 0.28      | Ploughsoil. Mid grey brown, silty clay.   |       |        |
| 12501       | Layer |         |           |           | Natural. Mid orange grey, silty clay with patches of light grey silty clay and gravels. |       |        |
| 12502       | Void  |         |           |           |   |       |        |
| 12503       | Cut   |         | 1.38      | 0.64      | Ditch   |       |        |
| 12504       | Fill  | 12503   | 0.14      | 0.64      | Secondary Fill. Mid blue brown grey, sandy silt.  |       |        |
| 12505       | Fill  | 12503   | 0.8       | 0.64      | Secondary Fill. Mid blue grey, silty sand.  |       |        |
| 12506       | Fill  | 12503   | 0.35      | 0.35      | Secondary Fill. Blue yellow grey, silty clay.   | Pot   | 40-410 |
| 12507       | Fill  | 12503   | 0.7       | 0.42      | Secondary Fill. Mid brown blue grey, silty sand.  | Pot   | LIA-ER |
| 12508       | Fill  | 12503   | 0.58      | 0.46      | Secondary Fill. Mid blue brown grey, silty sand.  |       |        |
| 12509       | Fill  | 12503   | 0.75      | 0.2       | Secondary Fill. Mid orange blue grey, silty sand.                                       | Pot   | 40-410 |

### Trench 126

#### General description

Trench devoid of archaeology. Consists of ploughsoil overlying natural geology of silty clay with gravels. Trench revealed 1 land drain.

| Orientation    | NE-SW |
|----------------|-------|
| Length (m)     | 30    |
| Width (m)      | 2     |
| Avg. depth (m) | 0.39  |

| Context No. | Type | Fill Of | Width (m) | Depth (m) | Description | Finds | Date |
|-------------|------|---------|-----------|-----------|-------------|-------|------|
|-------------|------|---------|-----------|-----------|-------------|-------|------|

|  |       |         |           |           |  |                |        |
|--|-------|---------|-----------|-----------|--|----------------|--------|
| 12600  | Layer |         |           | 0.3       | Ploughsoil. Mid grey brown, silty clay.  |                |        |
| 12601  | Layer |         |           |           | Natural. Mid orange grey, silty clay with gravels.                                       |                |        |
| <b>Trench 127</b>  |       |         |           |           |  |                |        |
| General description  |       |         |           |           |  | Orientation    | NW-SE  |
| Trench devoid of archaeology. Consists of ploughsoil and subsoil overlying natural geology of silty clay.  |       |         |           |           |  | Length (m)     | 30     |
|  |       |         |           |           |  | Width (m)      | 2      |
|  |       |         |           |           |  | Avg. depth (m) | 0.68   |
| Context No.  | Type  | Fill Of | Width (m) | Depth (m) | Description  | Finds          | Date   |
| 12700  | Layer |         |           | 0.29      | Ploughsoil. Mid grey brown, silty clay.  |                |        |
| 12701  | Layer |         |           | 0.27      | Subsoil. Mid yellow brown, silty clay.   |                |        |
| 12702  | Layer |         |           |           | Natural. Mid orange grey silty clay  |                |        |
| <b>Trench 128</b>  |       |         |           |           |  |                |        |
| General description  |       |         |           |           |  | Orientation    | E-W    |
| Trench revealed two possible pits and a ditch, which proved to be natural deposits on investigation. Ploughsoil and subsoil on sandy clay geology. |       |         |           |           |  | Length (m)     | 30     |
|  |       |         |           |           |  | Width (m)      | 2      |
|  |       |         |           |           |  | Avg. depth (m) | 0.51   |
| Context No.  | Type  | Fill Of | Width (m) | Depth (m) | Description  | Finds          | Date   |
| 12800  | Layer |         |           | 0.2       | Ploughsoil. Dark grey, clayey silt.  | Flint          |        |
| 12801  | Layer |         |           | 0.21      | Subsoil. Light grey yellow, silty clay.  | Pot            | 40-410 |
| 12802  | Layer |         |           |           | Natural. Light grey yellow, sandy clay.  |                |        |
| 12803  | Layer |         | 1.15      | 0.21      | Natural. Geological variation. Mid brown sandy clay.                                     |                |        |
| 12804  | Layer |         | 1.7       | 0.3       | Natural. Geological variation. Mottled light and dark grey patches in orange sandy clay. |                |        |

## Appendix B Finds Reports

---

### B.1 Pottery

By Kate Brady

#### Introduction

- B.1.1 Some 283 sherds of pottery, weighing 3.98kg, were recovered from the evaluation. The assemblage was scanned to identify diagnostic forms and fabrics, provide spot-dates and to generally characterise the material. The assemblage was also assessed in terms of conservation, discard and retention. Fabrics of prehistoric date were given codes based on their principal inclusion types and coarseness. Later Iron Age and Roman pottery fabrics were assigned codes from OA's standard recording system for material of that date (Booth 2016). Forms identified by rim were given codes from OA's system. Reference was also made to the National Roman Fabric Reference Collection (NRFRC; Tomber and Dore 1998), Going's (1987) type series of pottery from Chelmsford and the published assemblage recovered from the kilns at Mucking (Lucy and Evans 2016).
- B.1.2 Each context-group was quantified by sherd count and weight (grammes), and any rims present were additionally quantified by estimated vessel equivalent (EVE), which measures the percentage of rim circumference that survives (thus, 0.3 equals 30%). The total was 2.5 EVEs from 23 vessels identified by rim (MV). Pottery data by context is provided in Table 1.
- B.1.3 The following prehistoric fabrics were noted:
- F1 Flint temp LBA-EIA
  - SF1 Sandy with sparse flint MIA
- B.1.4 The following late Iron Age and Roman fabrics were noted (NRFRC codes in brackets):
- E30 Late Iron Age/early Roman sandy fabrics
  - E40 Late Iron Age/early Roman shelly fabrics
  - E80 Late Iron Age/early Roman grog-tempered ware (SOB GT)
  - E810 Late Iron Age/early Roman grog and sand tempered fabrics
  - O20 Sandy oxidised ware
  - R10 Fine reduced ware
  - R20 Sandy reduced ware
  - R30 Medium sandy reduced ware
  - S20 South-Gaulish samian ware
  - S30 Central-Gaulish samian ware
- B.1.5 Additionally, a small amount of post-Roman material was recorded:
- Glazed post-medieval redware
- B.1.6 The following forms identified by rim were recorded:
- C Indeterminate jar
  - CA Bucket shaped jar
  - CG Globular jar

- CJ Lid-seated jar
- CK Cooking pot type jar
- D Indeterminate jar/bowl
- HB Straight sided bowl
- HC Curving sided bowl

| Ctxt  | Count | Wt (g) | MV | EVE  | Notes   | Spot date |
|-------|-------|--------|----|------|---|-----------|
| 2107  | 3     | 14     | 1  | 0.06 | R20 everted rim D (EVE 0.06)  | 40-410    |
| 2111  | 1     | 3      | 0  | 0    | R10   | 40-410    |
| 2804  | 4     | 18     | 1  | 0.03 | O20 D (EVE 0.03) small everted rim  | 40-410    |
| 4108  | 1     | 2      | 0  | 0    | R30   | 40-410    |
| 7408  | 6     | 115    | 0  | 0    | R30 quite fine body sherds and flat base of jar   | 40-410    |
| 7706  | 1     | 8      | 1  | 0.05 | R30 rim of rob narrow mouthed jar   | 40-410    |
| 8105  | 1     | 6      | 0  | 0    | R20/E30?  | LIA/Rom   |
| 9604  | 3     | 9      | 0  | 0    | O20, O10  | 40-410    |
| 9611  | 31    | 371    | 0  | 0    | R20 flat base and body sherds (cremation vessel) No rim   | 40-410    |
| 9703  | 2     | 30     | 0  | 0    | O20   | 40-410    |
| 9808  | 14    | 124    | 0  | 0    | R20 body sherds   | 40-410    |
| 9827  | 5     | 114    | 0  | 0    | R30, O20  | 40-410    |
| 9909  | 1     | 15     | 1  | 0.08 | R20   | 40-410    |
| 10006 | 5     | 43     | 0  | 0    | O20   | 40-410    |
| 10008 | 1     | 2      | 0  | 0    | R20   | 40-410    |
| 10010 | 1     | 13     | 1  | 0.05 | R30 D rolled bead rim   | 40-410    |
| 10014 | 1     | 3      | 0  | 0    | R30   | 40-410    |
| 10103 | 5     | 115    | 0  | 0    | R20 body sherds   | 40-410    |
| 10204 | 1     | 2      | 0  | 0    | R10   | 40-410    |
| 10205 | 2     | 3      | 0  | 0    | S20   | 40-110    |
| 10305 | 2     | 17     | 0  | 0    | R20, R30  | 40-410    |
| 10308 | 4     | 61     | 0  | 0    | R30 body sherds.  | 40-410    |
| 10314 | 1     | 15     | 0  | 0    | R20   | 40-410    |
| 10509 | 2     | 131    | 0  | 0    | R30 body sherds including one very thick large sherd from a probable large storage jar  | 40-410    |
| 11604 | 1     | 6      | 0  | 0    | R10   | 40-410    |
| 11904 | 1     | 14     | 0  | 0    | R30   | 40-410    |
| 12506 | 1     | 2      | 0  | 0    | O20 small body sherd  | 40-410    |
| 12509 | 1     | 5      | 0  | 0    | R20   | 40-410    |
| 12801 | 2     | 3      | 0  | 0    | R20   | 40-410    |
| 2107  | 1     | 2      | 0  | 0    | sieving   | 40-410    |
| 9612  | 1     | 2      | 0  | 0    | sieving   | LIA/Rom   |
| 9613  | 2     | 5      |    |      | sieving   | LIA/Rom   |
| 9903  | 4     | 15     | 0  | 0    | sieving R20   | 40-410    |
| 2103  | 5     | 70     | 0  | 0    | R30, O10 poss hadham red ware   | 40-100    |
| 1703  | 2     | 5      | 0  | 0    | E80?  | LIA-ER    |
| 7207  | 1     | 14     | 0  | 0    | E810?   | LIA-ER    |
| 7403  | 3     | 21     | 0  | 0    | E810, E30   | LIA-ER    |
| 7412  | 1     | 3      | 0  | 0    | Blue and white painted  | Pmed      |
| 7704  | 24    | 514    | 4  | 0.46 | CG E40 and poss some leached ot shell Going G5 (EVE 0.16) heavy sooting on exterior, D E810 (EVE 0.20) plus body sherds of both, D E40 (EVE 0.10) (Going G19) jar/bowl with moulded nec (Going G16) | LIA-ER    |
| 7718  | 4     | 3      | 0  | 0    | Tiny body sherds  | M-LIA?    |

| Ctxt  | Count | Wt (g) | MV | EVE  | Notes   | Spot date |
|-------|-------|--------|----|------|---|-----------|
| 7806  | 3     | 29     | 0  | 0    | body sherd with scored chevron dec coarse sparse flint temper dark brown fabric   | MIA       |
| 7825  | 1     | 8      | 0  | 0    | sparse coarse flint temper similar fabric to 7806   | MIA       |
| 8107  | 1     | 7      | 0  | 0    | poss Pmed CBM   | Pmed?     |
| 9809  | 1     | 18     | 1  | 0.04 | R30 black flat top pointed bed rim neckless jar with cordons (going G3 2.1?) almost butt beaker shaped  | 40-100    |
| 9810  | 11    | 218    | 1  | 0.19 | E30 (Going G3 2.1) with cordon on shoulder (EVE 0.19) some body sherds internal sooting   | 40-100    |
| 9811  | 3     | 126    | 1  | 0.07 | E40 (with a little grog?) globular jar/bowl with everted squared rim (EVE 0.07) thick body sherd in E30   | LIA-ER    |
| 9812  | 21    | 222    | 2  | 0.2  | CG E40 sooted exterior (EVE 0.15) CA E30 sandy flat topped squared rim (EVE 0.05) poss , E810 body sherds prob LIA rather than ER, also a fine E30 body sherd with a cordon, quite begic                              | LIA-ER    |
| 9816  | 4     | 13     | 0  | 0    | M-LIA? Sparse fine flint temp   | MIA       |
| 9910  | 1     | 20     | 0  | 0    | coarse flint  | LBA?      |
| 10105 | 19    | 314    | 2  | 0.18 | HC R20 red surfaced sandy with soped flat rim (almost a bead) unusual (EVE 0.08), CD G24 (EVE 0.10)   | 100-410   |
| 10203 | 5     | 115    | 0  | 0    | E80   | LIA-ER    |
| 10310 | 27    | 603    | 1  | 0.24 | R20 CK (Going G9) EVE 0.24) not very flared also flat base sherd from this vessel poss drilled hole lower body wall, R30 body sherds with barbotine dec from pron beaker 2C, R10 body sherds, lots of R20 body sherds | 120-250   |
| 10311 | 3     | 89     | 2  | 0.31 | CJ R20 (going G5) sandy, wheel thrown, could go up to 3C (EVE 0.16) CK (BBW copy) Going G9 3.1 splayed rim (EVE 0.15)   | 200-250   |
| 10312 | 6     | 136    | 3  | 0.24 | R20 CJ Going G5 (EVE 0.05) R10 everted rim jar/bowl (can't find parallel), elongated neck (EVE 0.10), S32? long voids 18/31 (EVE 0.09) R30 body sherd   | 100-150   |
| 10507 | 3     | 35     | 2  | 0.15 | HB drop flange bowl (EVE 0.09), Going G24 jar (EVE (0.07) both R30  | 250-410   |
| 10900 | 1     | 20     | 0  | 0    | Glazed redware  | Pmed      |
| 11103 | 1     | 2      | 0  | 0    | flint temp  | LBA?      |
| 11811 | 4     | 5      | 0  | 0    | sparse flint tiny sherds  | M-LIA?    |
| 12507 | 2     | 15     | 0  | 0    | E810, E30   | LIA-ER    |
| 7806  | 5     | 39     |    |      | sieving   | MIA       |
| 8708  | 5     | 15     | 0  | 0    | sieving E40?  | LIA-ER    |
| 10507 | 4     | 11     |    |      | sieving residual LPRE? Sparse flint tiny sherds   | MIA?      |

Table 1: Summary and quantification of the pottery by context

Key: EVE estimated vessel equivalent; MV minimum number of vessels; LBA: Late Bronze Age; M/LIA mid/late Iron Age



## Prehistoric

- B.1.7 The earliest pottery recovered from the site dated to the late Bronze Age to early Iron Age and was a single flint tempered body sherd accounting for 0.35% of the site assemblage by sherd count. The sherd was recovered from a ditch in Trench 99 alongside a sherd of Roman date and is almost certainly residual.
- B.1.8 Twenty sherds in a single sand and sparse flint tempered fabric of probable middle Iron Age date were recovered in small quantities from Trenches 77, 78, 98, 105 and 118 and these accounted for 7% of the total assemblage by sherd count. All but one of these sherds were small undecorated body sherds, but one larger sherd was decorated with a lightly incised probable chevron pattern, which further suggests a middle Iron Age date.

## Late Iron Age to early Roman

- B.1.9 Some 23.3% of pottery by sherd count (66 sherds) was recovered from context-groups dated to the late Iron Age or early Roman period. The pottery was recovered from Trenches 17, 72, 74, 77, 87, 98, 102 and 125, and most of these groups were small. Only two groups were large, those from Trenches 77 and 98, and accounted for just over two thirds of the material dated to this period (45 sherds). The late Iron Age to early Roman material was in shell, grog, sand and grog and sand tempered fabrics.
- B.1.10 The largest group, recovered from a ditch in Trench 77, consisted of 24 sherds and included rim sherds. These rim sherds were from four vessels (0.46 EVEs). A globular jar in shell tempered fabric E40 was paralleled in Going's Chelmsford typology (form G5) and was heavily sooted on the exterior, suggesting use in a fire/ hearth. A jar/bowl also in this fabric had a moulded neck and everted rim, resembling Going's form G16. Another jar/bowl in this fabric was probably a Going form G19. The other vessel in this group represented by rim was in fabric E810 (grog and sand tempered and was only identifiable as a jar or bowl).

## Early Roman

- B.1.11 A total of 6% of the assemblage by sherd count (17 sherds) belonged to context-groups dated to the early Roman period (c AD 43-100). This material was recovered from Trenches 21 and 98 and included pottery of late Iron Age to early Roman tradition (particularly in fabric E40) in combination with pottery of certain post-conquest date, in fabrics R30 (sandy greyware), O10 (fine oxidised ware) and S20 (South-Gaulish samian ware). There was only one identifiable form, a neckless jar in fabric R30 with a flat-topped thick bead rim and a cordoned body. It was almost butt-beaker shaped and a similar rim form in the Going typology (G3 2.1) is dated to the early Roman period. This vessel was recovered from a ditch in Trench 98.

## Middle Roman

- B.1.12 A total of 12.7% of the assemblage by sherd count (36 sherds) belonged to contexts groups dated to the middle Roman period (c AD 120-250). This material was all recovered from a ditch in Trench 103 and included rims representing five vessels. These vessels included a cooking pot type jar in fabric R20 (a copy of a black-burnished ware form). This had a drilled hole in the vessel wall, close to the base, which is flat. The same context (10310) also contained body sherds from a possible beaker with barbotine dot decoration, likely to date to the 2nd century. Context 10311 contained a lid-seated jar in fabric R20 (Going form G5) and another cooking pot type

jar copy of a black-burnished ware form. This vessel had a more widely splayed rim (Going form G9 3.1), a chronological indicator of a later date and the combination of vessels in his context suggests a date in the first half of the third century for this context. Context 10312 contained the rim of an everted rim jar/bowl in fabric R10 with an elongated gently curved neck which it has not been possible to closely date, but this was found alongside a body sherd of Central-Gaulish samian ware, suggesting a 2nd century or slightly later date for this group.

- B.1.13 A further group recovered from Trench 101 (context 10105) was more broadly dated to the mid to late Roman period by the rim sherd of a curving sided bowl. The rim is unusual, with a flat sloping top creating a diagonal flange. A similar (but not the same) form in the Going typology is bowl form E3, which dates to the late Roman period (more specifically to the early 4th century) although the rim sherd is not similar enough to confidently assign a late Roman date for this context and therefore has been assigned a broader date.

### **Late Roman**

- B.1.14 A single context group (10507) from a pit or ditch terminus totalled 1% of the assemblage by sherd count and dated to the late Roman period (c AD 200/230-410). This assemblage included a rim and part of the body of a straight sided flanged bowl, which is a copy of a black-burnished ware form. This is a late Roman form, dating from c AD 250 onwards.

### **Roman**

- B.1.15 Some 39.6% of the assemblage by sherd count (112 sherds) was broadly dated to the Roman period. This assemblage was mostly made up of body sherds or small undiagnostic rim sherds but included a vessel recovered from a possible cremation burial (context 9611). The sherds included body sherds and a flat base fragment in very sandy greyware, possibly a local product.

### **Post-Roman**

- B.1.16 Two sherds of post-medieval pottery were recovered from the site. These were a sherd of post-medieval glazed red ware from the topsoil in Trench 109 and a sherd from a posthole in Trench 74. Both are 18th or 19th century in date.

### **Discussion**

- B.1.17 The pottery spans the prehistoric and Roman periods, from the single sherd of late Bronze Age to early Iron Age body sherd and the small group of middle Iron Age material in the south-west of the site to the more widely dispersed late Iron Age and Roman material. A very small amount of post-medieval pottery was the latest material recovered.
- B.1.18 Overall, the assemblage was in moderate condition. The mean sherd weight (weight divided by sherd count) is 14.1g, which is characteristic of an assemblage of medium sized fragments. This suggests that the pottery was deposited relatively near to its place of use, confirming domestic/settlement activity within the site.
- B.1.19 The forms are consistent with those manufactured in the region and most vessels were paralleled at Mucking (Lucy and Evans 2016) and/ or Chelmsford (Going 1987).
- B.1.20 The fairly small range of fabrics recovered, with little from other regional industries and few imports further suggests that the assemblage was dominated by wares made

on the site or locally, with the very sandy micaceous fabrics likely derived from the local siliclastic sediments of the Thanet formation found within the near vicinity of the site (BGS 2020).

- B.1.21 Assessment of status is difficult, due to the small size of the assemblage. However, the presence of samian ware demonstrates access to imports in the early and middle Roman periods, and that Roman dining traditions and the use of table wares is evidenced.

#### **Conservation, discard and retention of material**

- B.1.22 The pottery reported on here has the potential to inform future research through re-analysis and thus it is recommended that all the pottery is retained. This follows the advice set out in the 'Standard for Pottery Studies in Archaeology' (PCRG, SGRP, MPRG 2016).

## B.2 Ceramic building material

By Ruth Shaffrey

### Introduction

B.2.1 A total of 33 fragments of ceramic building material (CBM) weighing 2.4kg were recovered, which are listed and summarily categorised in Table 2 below.

### Ceramic Building Material

B.2.2 The assemblage of CBM is highly fragmented and comprises pieces of indeterminate form (14 fragments), flat tile (14 fragments), brick (4 fragments) and 1 other (a modern pipe from context 2087). The CBM of indeterminate form from contexts 12304 and 9812 is not dateable.

| Ctxt  | Count | Wt (g) | Date                     | CBM form | Fabric  | Form notes/description   |
|-------|-------|--------|--------------------------|----------|---|--|
| 2203  | 1     | 21     | Medieval / post medieval | Flat     | Dark red sandy fabric with coarse sandy moulding sand                             |  |
| 2087  | 1     | 34     | Modern                   | Pipe     | Hard red gritty fabric  | Modern pipe with curved profile  |
| 5604  | 5     | 26     | Post-Roman               | Flat     | Hard orange fabric, no obvious inclusions   | Very thin fragments. Fragmented along laminations                              |
| 9812  | 1     | 85     | IA/Roman                 | Brick    | Orange red silty fabric   | One with a flat side and part of another flat surface                          |
| 9812  | 1     | 111    |                          | Indet.   | Orange red silty fabric   | Other more amorphous but same fabric   |
| 9815  | 1     | 17     |                          | Flat     | Orange silty fabric no obvious inclusions   | No edges   |
| 10105 | 1     | 448    | Roman                    | Brick    | Silty orange red fabric with very occasional quartz grain and laminated           | Three original faces. One with some knife trimming along an edge               |
| 10404 | 1     | 507    | Post-Roman               | Brick    | Hard red gritty fabric with larger flint inclusions                               | End fragment of brick, probably med or post med                                |
| 12304 | 7     | 257    | Post-Roman               | Flat     | Orange silty fabric no obvious inclusions   | Flat tile  |
| 12304 | 7     | 220    |                          | Indet.   | Fine sandy orange fabric with regular ferruginous inclusions and occasional flint | One fragment has a flat face indicating it is structural but rest is amorphous |
| 12304 | 6     | 496    |                          | Indet.   | Hard red gritty fabric. Not Roman. Modern?  | Amorphous lumps  |
| 12304 | 1     | 122    | Modern                   | Brick    | Hard red gritty fabric. Not Roman. Modern?  |  |

Table 2: Catalogue of ceramic building material

B.2.3 The 14 pieces of flat tile from contexts 2203, 5604, 9815 and 12304 are of medieval or post-medieval form. The fragment from context 2203 is a hard, red, sandy fabric. The remainder are fragments of an orange silty fabric.

- B.2.4 The four fragments of brick include one post-medieval example (12304), one medieval or post-medieval example (10404) and two of probable Roman date (9812, 10105). The latter two are of a pale orange silty fabric whilst the two post-Roman fabrics are of hard red gritty fabric.
- B.2.5 The ceramic building material assemblage is small and indicative of low levels of activity that required this type of material.

#### **Retention and Discard**

- B.2.6 The possible Roman bricks should be retained. The remainder of the material may be discarded.

## B.3 Fired clay

By Ruth Shaffrey

### Introduction

- B.3.1 A total of 39 pieces of fired clay weighing 2.1kg were recovered, which are listed and summarily categorised in Table 3 below.
- B.3.2 All the fired clay appears to be structural in nature, although most (35 fragments) is of undiagnostic form. A single fragment from context 7710 has a slim wattle impression in one face. The fired clay is probably of a single fabric, which is a pale peach coloured silty fabric with some sand, including moulding sand (FC fabric A). Fragments from contexts 2107, 9812 and 10105 are harder but this is probably because they are very heavily burnt and blackened.
- B.3.3 Fragments of four fired clay 'bricks' were recovered from contexts 7704, 9808 and 12304. These are likely to be fire bars from a pottery kiln.

| Ctxt  | Count | Wt (g) | Item date | Fabric   | Form   | Form notes   |
|-------|-------|--------|-----------|--|--------|--|
| 2107  | 1     | 31     | Indet.    | Hard but blackened                                 | Indet. | Amorphous lump   |
| 4108  | 1     | 13     | Indet.    | FC fabric A  | Indet. | Amorphous lump   |
| 7704  | 1     | 383    | Roman     | FC fabric A with a grey core                       | Brick  | Firebar. Four smoothed faces, other two damaged. Some coarse sandy mortar on surviving end |
| 7710  | 1     | 21     | IA/Roman  | FC fabric A  | Indet. | Has section of one slim wattle on one edge but otherwise is an amorphous lump              |
| 9808  | 1     | 60     | Roman     | Very hard silty fabric. Burnt and blackened though | Brick  | Has remains of two flat adjacent faces   |
| 9812  | 7     | 230    | Indet.    | Hard but blackened                                 | Indet. | One piece with a flat face, others small and amorphous                                     |
| 9604  | 2     | 65     | Indet.    | FC fabric A  | Indet. | Non diagnostic lumps   |
| 10105 | 1     | 144    | Indet.    | Very hard silty fabric, burnt and blackened        | Indet. | Amorphous lump   |
| 12304 | 22    | 609    | Indet.    | FC fabric A  | Indet. | Amorphous lumps  |
| 12304 | 2     | 528    | Indet.    | FC fabric A  | Brick  | Fragments. One with four flat moulded surfaces   |

Table 3: Catalogue of fired clay

### Retention and Discard

- B.3.4 The fired clay with wattle impressions and possible fire bars should be retained. The remainder of the material may be discarded.

## B.4 Flint

By Michael Donnelly

### Introduction

- B.4.1 A small assemblage of 25 struck flints and 86 fragments of burnt unworked flint weighing 536g was recovered from this evaluation (Table 4). The struck flint was widely dispersed across the evaluation area generally in quite low numbers but there were increased numbers in Trenches 75-78, 87-89 and 96-99. Trench 96 contained a very fine knife of probable late Neolithic or early Bronze Age date while several blades, early tool forms and bladelet cores indicate an early prehistoric presence that included some quite large blades. (Early prehistoric is here used to describe blade technologies that may be of late Upper Palaeolithic, Mesolithic or early Neolithic date).

### Methodology

- B.4.2 The artefacts were catalogued according to OA South's standard system of broad artefact/debitage type (Anderson-Whymark 2013; Bradley 1999), general condition noted and dating was attempted where possible. The assemblage was catalogued directly onto an Open Office spreadsheet. During the assessment additional information on condition (rolled, abraded, fresh and degree of cortication), and state of the artefact (burnt, broken, or visibly utilised) was also recorded. Retouched pieces were classified according to standard morphological descriptions (e.g. Bamford 1985, 72-77; Healy 1988, 48-9; Bradley 1999). Technological attribute analysis was initially undertaken and included the recording of butt and termination type (Inizan *et al.* 1999), flake type (Harding 1990), hammer mode (Onhuma and Bergman 1982), and the presence of platform edge abrasion.

| Category Type                | Number        |
|------------------------------|---------------|
| Flake                        | 15            |
| Blade                        | 2             |
| Bladelet                     | 1             |
| Blade index                  | 16.67% (3/18) |
| Irregular waste              | 1             |
| Core opposed platform blades | 1             |
| Core other bladelets         | 1             |
| Scraper end                  | 1             |
| Knife backed                 | 1             |
| Knife scale-flaked           | 1             |
| Retouched blade              | 1             |
| Total                        | 25            |

|                                |            |
|--------------------------------|------------|
| Burnt unworked                 | 86/536g    |
| No. burnt (%)                  | 2/25 (8%)  |
| No. broken (%)                 | 8/25 (32%) |
| No. cores/related debitage (%) | 2/25 (8%)  |
| No. retouched (%)              | 4/25 (16%) |

Table 4: Breakdown of flint assemblage by type

### Raw material and condition

- B.4.3 Flint was the sole material represented here and came with a variety of cortical states indicating that a range of sources was exploited with no dominant type. Chalk cortex was found on 6 examples (33.33%), but five of these were quite heavily weathered

indicating a secondary source. Thin abraded cortex typical of some North Downs material accounted for five examples (27.78%). This was followed by four with rolled/gravel cortex (22.22%), two with banded cortex (11.11%) from Bullhead Beds material (Dewey and Bromehead 1915), and there was a single example with a thermal cortical surface (5.56%).

- B.4.4 The flints were in mixed condition with the majority being lightly edge damaged (11/23, 47.83%) followed by fresh (5/23, 21.74%), moderate (4/23, 17.39%), plough damaged (2/23, 8.70%) and heavily damaged (1/23, 4.35%). Cortication was largely light (18/23, 78.26%) with few flints displaying moderate cortication (3/23, 13.04%) and single examples with heavy or no cortication (4.35% each). Overall, the condition of the material suggests an assemblage that is quite heavily disturbed, mixed and potentially representative of several periods.

### **Discussion**

- B.4.5 The assemblage was small but contained a very high tool component at 16% and high figures for cores of 8%, indicative of a selectively recovered assemblage where the more obvious pieces are picked up and less obvious flake debitage and chunks were largely missed. Despite this, there is a clear pattern to the material with two very early looking bladelet cores with two or more platforms, although the second example which has three platforms probably utilised the third as a form of rear cresting. Several narrow blades or bladelets were also present as were two larger pieces, a flake and a blade both with very parallel dorsal negative scars. Both cores were exclusively geared towards blade or bladelet production, but the assemblage as a whole had only a moderate blade index of 16.67% (Ford 1987).
- B.4.6 One retouched blade was recovered from context 6400, and an end scraper on an elongated core preparation flake with minimalist retouch from context 7822. Both are probably Mesolithic or early Neolithic in date.
- B.4.7 Two probable Neolithic or early Bronze Age knives were also recovered. One was a simple naturally backed form on a side trimming flake from context 8900, the other a very much more accomplished piece from 9603, a short, broad triangular flake that was invasively worked along all three edges. This piece is very likely to be late Neolithic or early Bronze age in date, and is reminiscent of the types found in burial or ritual contexts.
- B.4.8 There were no typically later prehistoric flints such as very basic core forms or squat hard-hammer flakes, but several contexts did yield large, burnt flint potboilers, and some or all of these could relate to the use of flint for domestic purposes in the later prehistoric or Roman periods.
- B.4.9 Although few, the flints include many fine pieces. Moreover, the possible bias of unintentional selective recovery indicated by the composition of the assemblage suggests that flints may have been more common on site than recovered assemblage implies. Future work has the potential to recover additional flintwork, with a moderate likelihood of identifying additional fine tools like the knife (potentially in important contextual relationships such as graves).



## B.5 Metalwork

By Anni Bayard

### Introduction

- B.5.1 The evaluation yielded 126 objects weighing a total of 655.1g recovered from 10 contexts. Most objects were of iron and in fragmentary and corroded condition. Nails recovered from the subsoil are of indeterminate date. Twenty-six copper alloy objects were recovered (12.4g), representing five artefacts, including a farthing of George III (AD 1760-1820) recovered from the ploughsoil. The metal finds are tabulated by context in Table 5.
- B.5.2 Most of the metal finds derived from Trench 87. A collection of nails and fragments were recovered from the disturbed soil above unexcavated feature 8707 and are of probable post-medieval to modern date. This level also yielded 17 fragments of triple-stranded copper electrical wire, again of modern date. A single possible pin or rivet from this layer is likely to be of similar date.
- B.5.3 The upper levels of pit 8704 are noted as having been badly disturbed. Several iron nail fragments and an unidentified copper alloy fragment were recovered from the fill of this feature, as were several pieces of the rim of a probable small bucket/tin caddy or billy can. Another fragment of the can was recovered from the ploughsoil. All are likely to date to the modern period.
- B.5.4 Only two artefacts were recovered from the primary fills of ditches. The first object is the heaviest in the assemblage (530g) and is a complete sickle bar mower tooth, part of an agricultural machine for cutting grass and dating from c 1850-1950. This was found in the primary fill of ditch 10403. The second object is a nail of probable Roman date, recovered from the terminus of ditch 10506 and associated with a quantity of later Roman pottery.

| Ctxt | Type           | SF no. | Material     | Count | Weight (g) | Description                          | Date      |
|------|----------------|--------|--------------|-------|------------|--------------------------------------|-----------|
| 8700 | Ploughsoil     | 4      | Iron and tin | 6     | 3.6        | Billy can rim fragments              | Modern    |
| 8705 | Cremation fill | 5      | Copper alloy | 1     | 2          | Query-electrical?                    | Modern?   |
|      |                | 5      | Iron         | 9     | 14.8       | Nail and billy can fragments         | PM-Modern |
| 8707 | Pit            | 6      | Copper alloy | 17    | 3.8        | Electrical wire                      | Modern    |
|      |                | 8, 12  | Iron and tin | 24    | 20         | Nail and billy can fragments         | PM-Modern |
| 8708 | Subsoil        | n/a    | Copper alloy | 6     | 1.4        | Electrical wire                      | Modern    |
|      |                | 1      | Iron slag    | 1     | 4          | Iron slag/waste                      | Uncertain |
|      |                | 11     | Iron         | 3     | 3          | Nails                                | Uncertain |
| 9812 | Ditch fill     | n/a    | Uncertain    | 1     | 14.4       | Conglomerate (uncertain composition) | Uncertain |

| Ctxt  | Type            | SF no. | Material     | Count | Weight (g) | Description                               | Date        |
|-------|-----------------|--------|--------------|-------|------------|---|-------------|
| 9829  | Mole drain fill | 4      | Iron         | 1     | 20.5       | Amorphous lump                            | Uncertain   |
| 10402 | Remnant topsoil | 3      | Iron         | 2     | 22.5       | Amorphous lump                            | Uncertain   |
| 10404 | Ditch fill      | n/a    | Iron         | 1     | 530        | Sickle bar mower tooth                    | Modern      |
| 10507 | Ditch fill      | 2      | Iron         | 1     | 5.9        | Nail                                      | Roman       |
| 11600 | Ploughsoil      | 1      | Copper alloy | 1     | 4          | Farthing coin of George III dated 177[2?] | PM / modern |

Table 5: Metal finds by context

### Retention and Discard

B.5.5 None of the metal artefacts are worthy of retention.

### C.1 Environmental Samples

By Richard Palmer

#### Introduction

- C.1.1 The Thirteen samples were taken from the evaluation at North of Stifford, Lower Thames Crossing, primarily for the retrieval and assessment of charred plant remains (CPR) and the recovery of bones and artefacts.

#### Method

- C.1.1 The samples were processed in their entirety at Oxford Archaeology using a modified Siraf-type water flotation machine. The flots were collected in a 250µm mesh and heavy residues in a 500µm mesh and dried. The residue fractions were sorted by eye and with the aid of a magnet while the flot material was sorted using a low power (x10) binocular microscope to extract cereal grains and chaff, smaller seeds and other quantifiable remains.

#### Results

- C.1.2 Sample and CPR flot data is summarised in Table 6.
- C.1.3 **Trench 21.** Sample 14 came from fill 2106 of ditch 2104. Some of the recovered charcoal was fragments of twig but generally the charcoal is of small size with at least one plane <2mm, which hinders further identification. No finds were recovered from the residue.
- C.1.4 Sample 15 came from fill 2107 of ditch 2104 which is of Roman date. All recovered material is small (<4mm) and the single grain could not be further identified due to damage. Pottery was recovered from the residue.
- C.1.5 **Trench 77.** Sample 2 was taken from fill 7708 of pit 7707. A large quantity of charcoal was recovered with 25-100 fragments >4mm in size, some of which are ring porous. A large quantity of burnt flint was recovered from the residue.
- C.1.6 **Trench 78.** Sample 1 came from fill 7806 of ditch 7804 which is of middle Iron Age date. Recovered charcoal mostly falls in the 2-4mm size category. The most common plant identified in the weed assemblage is charred goosefoot (*Chenopodium* sp.). Pottery and burnt stone were recovered from the residue.
- C.1.7 **Trench 87.** The samples from this trench were retrieved from deposits interpreted during the fieldwork as being a cremation or activities relating to this. Samples were taken at 5cm intervals from the 'cremation' pit fill and bulk samples were recovered from the possible associated deposits. Due to the large flot volumes each sample is considered individually.
- C.1.8 Sample 4 was taken from topsoil 8700, associated with cremation 8702. The flot is a mix of charcoal and clinker-like charred material. Two fragments of cremated bone, iron, clay pipe and further clinker-like material were recovered from the residue.
- C.1.9 Sample 5 came from fill 8705 of cut 8704 and is the first 5cm spit. A fairly small quantity of recovered charcoal (under 50 frags) is present in a flot that is dominated

by clinker-like and heavily vitrified material. Very small fragments of cremated bone and iron were recovered from the residue.

- C.1.10 Sample 6 was taken from the second spit of fill 8705 in cremation pit cut 8704. As with sample 5 charcoal makes up only a small proportion of recovered material with the bulk of the flot being clinker-like charred material and other highly vitrified items. A little burnt stone was recovered from the residue.
- C.1.11 Sample 7 came from the third spit of fill 8705 of cremation cut 8704. The quantity of recovered charcoal is low, but twig is present, some of the fragments are probably ring porous. The bulk of the flot is made up of clinker-like, coal-like and highly vitrified material. Calcined bones and burnt stone were recovered from the residue.
- C.1.12 Sample 8 came from the plough disturbed layer 8708 over and around pit 8704. Charcoal is present but the bulk of the flot is clinker, coal and heavily vitrified charred material. Pottery, iron and calcined bones were recovered from the residue.
- C.1.13 Sample 11 was also taken from context 8708. Limited charcoal was recovered with the bulk of the flot again consisting of clinker and heavily vitrified material. Cremated bone, iron and copper were recovered from the residue.
- C.1.14 Sample 12 is from second spit of layer 8708. A small quantity of charcoal is present in the flot but as with the other samples from the trench most of the flot is composed of clinker and heavily vitrified material. Some of the clinker like material has elements that suggest it could originally have been grain but quantities and condition of the material mean that this is not confirmable. The residue produced pottery, iron and copper alloy.
- C.1.15 **Trench 96.** Sample 9 is from fill 9612 of cremation cut 9610. No charred material >2mm was recovered and a single heavily damaged grain was the only identifiable object in the flot. Cremated bone and pottery were recovered from the residue.
- C.1.16 Sample 10 is from context 9613 which is the fill outside a cremation pot. Two fragments of charcoal are the only significant items present in the flot. Cremated bone was recovered from the residue.
- C.1.17 **Trench 99.** Sample 3, from fill 9903 of ditch 9902, produced a small flot mostly of fine sand and modern plant material. Burnt flint and pottery were recovered from the residue.
- C.1.18 **Trench 105.** Sample 13, from fill 10507 of ditch 10506, has been dated as late Roman. Little charred material was recovered in the flot, but a single grain of barley (*Hordeum vulgare*) was identified. Pottery and burnt stone were recovered from the residue.

## Discussion

- C.1.19 The only mode of preservation evident in the sampled contexts and features is charring, and typically the quantity and quality of charred remains is low. Sample 2 from pit 7707 was the most productive sample, with a large quantity of identifiable charcoal recovered in addition to quantities of burnt flint. Further identification of the charcoal would be possible but would only be worthwhile if the feature was dated as earlier prehistoric. A nearby feature was dated as Roman, but no direct dating of this deposit is available.

- C.1.20 Two sets of samples, those from Trenches 87 and 96 are either from possible cremation spits or associated with cremations. Samples 9 and 10, both from the cremation in Trench 96, produced very little material.
- C.1.21 The samples from Trench 87 were taken as cremation samples and calcined bone was recovered from most of the residues and is being reported elsewhere. The quantities of calcined bone were, however, small and animal bone was recovered more frequently from these samples. The flots from these samples produced large quantities of clinker which is more suggestive of the deposition of industrial waste. If confirmed as cremations, they were clearly heavily disturbed. Sample 4 is from the subsoil and topsoil interface and this has been subject to ploughing.
- C.1.22 Nearly all other sampled features on site are ditches and these were not productive in terms of charred or other organic material. This is not unexpected if the ditches are located away from areas of occupation.

| Sample no. | Context no. | Trench | Feature/Deposit | Date | Sample vol. (L) | Flot vol. (ml) | Charcoal >2mm | Grain | Chaff | Weeds | Notes                                   |
|------------|-------------|--------|-----------------|------|-----------------|----------------|---------------|-------|-------|-------|---|
| 1          | 7806        | 78     | 7804            | MIA  | 40              | 20             | +++           |       | +     | ++    | 10YR 4/6 sandy silt loam.               |
| 2          | 7708        | 77     | 7707            | IA   | 40              | 250            | ++++          |       |       | +     | 10YR 2/2 sandy silt loam.               |
| 3          | 9903        | 99     | 9902            |      | 40              | 10             |               |       |       |       | 10YR 4/2 sandy silt loam.               |
| 4          | 8700        | 87     | 8700            |      | 4               | 19             | +++           |       |       |       | 10YR 4/3 sandy clay.                    |
| 5          | 8705        | 87     | 8704            |      | 14              | 75             | +++           |       |       |       | 10YR 5/6 sandy clay loam.               |
| 6          | 8705        | 87     | 8704            |      | 3               | 75             | +++           |       |       |       | 10YR 5/6 sandy clay loam.               |
| 7          | 8705        | 87     | 8704            |      | 7               | 275            | +++           |       |       |       | 10YR 5/6 sandy clay loam.               |
| 8          | 8708        | 87     | 8706            |      | 16              | 175            | +++           |       |       |       | 10YR 5/6 sandy clay loam.               |
| 9          | 9612        | 96     | 9610            |      | 3               | 4              |               | +     |       |       | 10YR 4/2 sandy clay.                    |
| 10         | 9613        | 96     | 9610            |      | 3               | 3              | +             |       |       |       | 10YR 5/3 sandy clay.                    |
| 11         | 8708        | 87     | 8708            |      | 7               | 55             | ++            |       |       |       | 10YR 5/6 sandy clay.                    |
| 12         | 8708        | 87     | 8706            |      | 7               | 300            | +++           |       |       |       | 10YR 5/6 sandy clay.                    |
| 13         | 10507       | 105    | 10506           | LR   | 40              | 12             | +             | +     |       | +     | 10YR 4/3 sandy silt loam. Modern roots. |
| 14         | 2106        | 21     | 2104            |      | 20              | 5              | ++            |       | +     |       | 2.5Y 5/2 silty clay loam.               |
| 15         | 2107        | 21     | 2104            | R    | 20              | 5              | +             | +     |       | +     | 2.5Y 4/4 silty clay.                    |

Table 6: Assessment of CPR flots

Key: +=present (up to 5 items), ++=frequent (5-25), +++=common (25-100), ++++=abundant (100+).  
IA=Iron Age, LR=Late Roman, R=Roman

## Recommendations

- C.1.23 The flots warrant retention until all works on site are complete but further analysis of the flots described here is not merited at this time.

The charcoal from sample 2 should be considered for further identification as part of a larger material assemblage in the event of further excavation and assessment at the site.

## C.2 Human Remains

By Louise Loe

### Introduction and provenance

- C.2.1 Burnt bone from five contexts (7806, 8700, 8707, 9612, 9613) was received for analysis. Deposit 9612 was recovered from heavily truncated urn 9611. Deposit 9613 was recovered from around the urn. The urn dates these deposits to the Roman period. Deposit 7806 was recovered from the fill of ring ditch 7804 which contained Middle Iron Age pottery; 8700 was from the modern topsoil of Trench 87 and 8708 (=8707) was from a plough disturbed horizon over and around pit 8704. No burnt bone was submitted from the fills of pit 8704 itself (Samples 5, 6 and 7), as nothing larger than 2mm was found.

### Methodology

- C.2.2 Excavation was in accordance with recommended practice (McKinley and Roberts 1993) for urned and unurned cremations and involved spit excavation and bulk recovery, as appropriate. Deposit 9612 was excavated from urn 9611 in the field, because the urn was heavily truncated and broken. The deposit was 7mm thick and a 18mm in extent.
- C.2.3 All deposits were processed by wet sieving which sorted them into fractions of >10mm, 10-4mm, 4-2mm and 2-0.5mm. These were further sorted to separate the bone from extraneous material such as stones. Bone was only present in the >10mm and 10-4mm fractions in deposits 7806, 8700, 8708. For 9612 and 9613, bone was sorted from a 20% sample of the total weight of the 4-2mm sieve fractions. The samples were then used to estimate the total proportion of bone present. No bone was present in the 2-0.5mm sieve fractions.
- C.2.4 All bone was analysed to confirm species (e.g. human or non-human animal), record colour, weight and maximum fragment size. Each fraction was examined for identifiable bone elements and the presence of pyre and/or grave goods. The minimum number of individuals (MNI) present was estimated based on the identification of repeated elements and/or the presence of juvenile and adult bones in the same deposit. Where possible, estimation of age and sex was attempted following published methods (Buikstra and Ubelaker 1994, Scheuer and Black 2000).

### Results

- C.2.5 A summary of the findings is given in Table 7. Information on fragmentation and skeletal elements represented is provided in Tables 8 and 9 respectively.

| Ctxt       | Type                                    | Date  | Sample no. | weight (g) | Colour                     | identification   | Age | Sex | Inclusions/<br>staining   | Non-metrics/<br>pathology/<br>burnt<br>and<br>unburnt |
|------------|---|-------|------------|------------|----------------------------|--|-----|-----|---|---|
| 7806       | Fill or ring ditch                      | ?MIA  | 1          | 0.9        | White: 100%                | Possible human (1x fragment of long bone shaft only)               | ?   | ?   | 0   | MNI = 1   |
| 8700       | Topsoil of trench 87                    | ?     | 4          | <0.0       | White: 100%                | Possibly non-human (1 unidentified and 1 ?long bone fragment only) | -   | -   | 0   | -   |
| 8707 =8708 | Plough disturbed horizon overlying 8704 | ?     | 8          | <0.0       | White: 100%                | 1 x unidentified fragment only                                     | -   | -   | 0   | -   |
| 9612       | Urned cremation                         | Roman | 9          | 209        | White: c 95%<br>Grey: c 5% | Human (multiple identified & unidentified fragments)               |     |     | 1 x possible hobnail; 2 x possible animal fragments (burnt); iron staining on several fragments | MNI=1; Late adolescent/adult                          |
| 9613       | Backfill around 9612                    | Roman | 10         | 11.6       | White: c 95%<br>Grey: c 5% | Human (multiple identified & unidentified fragments)               | ?   | ?   | Occasional flecks of charcoal   | MNI-1   |

Table 7: Burnt bone – Osteological Summary

Key: ?=indeterminate.

| Ctxt | Weight (g) | >10mm (g)      | 10-4mm (g)    | 4-2mm (g)    | Max. frag. size                      |
|------|------------|----------------|---------------|--------------|--------------------------------------|
| 7806 | 0.9g       | 0              | 0.9g (100%)   | 0            | 19mm: splinter of long bone shaft    |
| 8700 | <0.0g      | 0              | <0.0g (100%)  | 0            | 10mm: ?long bone fragment            |
| 8707 | <0.0g      | 0              | <0.0g (100%)  | 0            | 9mm: unidentified                    |
| 9612 | 209.2g     | 131.9g (63.0%) | 72.1g (34.0%) | 5.2g* (2.5%) | 50mm: fragment of distal femur shaft |
| 9613 | 11.6g      | 3.6g (31.0%)   | 7.9g (68.1%)  | 0.1g* (0.9%) | 14mm: unidentified long bone shaft   |

Table 8: Burnt bone - Summary of Fragmentation

\* Estimated weights based on sorting bone from a 20% sample of the total residue (see methods statement)



- C.2.6 **Contexts 7806, 8700 and 8707.** It was not possible to confirm the species identification of the bone from these contexts, because they lacked morphological features. Deposit 7806 comprised one fragment of long bone shaft and is possibly human. Deposit 8700, a possible fragment of long bone shaft and one unidentified bone fragment, is possibly non-human animal and 8707, an unidentified fragment, primarily comprising trabecular bone, is 'unknown'. The fragments weighed less than 0.0g (8700 and 8707) and 0.9g (7806).
- C.2.7 The fragments from 7806, 8700 and 8707 were all recovered from the 10-4mm sieve fraction and were moderately fragmented. The largest fragment (? long bone) was from 7806 and measured 19mm. They were all fully calcined (white).
- C.2.8 **Contexts 9612 and 9613.** Bone from 9612 and 9613 were positively identified as human. Identified fragments included femur shaft, tibia shaft, fibula shaft and foot bones (including the head of the proximal phalanx of the first metatarsal) and two fragments of cranial vault. This was in addition to trabecular rich bone fragments, probably either tarsals and/or joints and unidentified fragments of long bone shaft.
- C.2.9 The total weight of the bone from 9612 was 209.2g and the total weight of bone from 9613 was 11.6g. A low level of fragmentation was observed in 9612. The largest proportion of bone from 9612 was from the >10mm fraction (63%; 131.9g), followed by the 10-4mm fraction (34%;72.1g). Only 2.5% (5.2g) of the deposit was from the 4-2mm fraction. The largest bone fragment was a piece of femur shaft which measured 50mm.
- C.2.10 The fragmentation of bone from 9613 was low to moderate. A high proportion (68.1%; 7.9g) of the bone was from the 10-4mm sieve fraction, while 3.6g (31.0%) comprised the >10mm fraction and 0.1g (0.9%), the 4-2mm fraction. The largest fragment, an unidentified long bone shaft, measured 14mm.
- C.2.11 Approximately 5% of both deposits comprised fragments which were grey on their internal surfaces. This included a fragment of skull (9613) and unidentified long bone fragments (9612). The rest of the bone from both contexts was white.
- C.2.12 Iron staining was present on the internal and external surfaces of several of the lower limb bones from 9612, including fragments of femur, tibia and fibula shafts and foot bones. A small (c <10mm) object was also identified from this context and has been tentatively identified as a possible highly corroded hob nail. It was not possible to say whether it was burnt. In addition, two fragments of burnt bone were possibly non-human animal. Very occasional flecks of charcoal were present in 9613 and further charcoal was excavated with 9612.
- C.2.13 None of the contexts had repeated elements, nor landmarks indicating conflicting age or sex estimations. Therefore, each context represents a minimum of one individual each. It was not possible to estimate the sex of any of the bones, because there were no diagnostic features present. The overall size and morphology of the bones from 9612 and 9613 are consistent with an older adolescent or adult. No pathology or non-metric traits were observed.

| Skeletal Element |                                      |       |            |  |   |  |        |
|------------------|--------------------------------------|-------|------------|--|---|--|--------|
| Ctxt             | Skull                                | Axial | Upper Limb | Lower Limb   | Unid. Long Bone   | Unid. Other                                    | TOTAL  |
| 9612             | 1 fragment vault with suture<br>0.5g | None  | None       | Femur shaft<br>17.9g<br>Tibia shaft<br>10.6g<br>Fibula shaft<br>14.2g<br>First MT phalanx head<br>1.7g<br>Tarsals<br>10.7g | Trabecular bone (joints/tarsals)<br>53.8g<br>Long bone shaft<br>56.6g | 43.2g  | 209.2g |
| 9613             | 1 fragment of vault<br>0.4g          |       |            |  | Long bone shaft<br>1.9g   | Trabecular bone<br>2.1g<br>Unidentified<br>7.2 | 11.6g  |

Table 9: Burnt Human Bone - Summary of identified elements  
Key: MT = Metatarsal

### Discussion

- C.2.14 Deposits 7806, 8700 and 8707 comprised only a very little bone, which could not be confidently identified. The only possible human bone was one small fragment of long bone shaft (7806), from a ring ditch which contained middle Iron Age pottery. Given that the metal finds from the contexts in Trench 87 have been dated as modern, it appears very unlikely that pit 8704 contained a human cremation.
- C.2.15 The remainder of this discussion concerns 9612 and 9613. Context 9612 was recovered from urn 9611, within pit 9610. It is likely that 9613, recovered from the backfill of pit 9610, had once been part of the same deposit. Thus, 9612 and 9613 are discussed as one deposit and event.
- C.2.16 The weights of the deposits, even when combined (220.8g), are well below the expected ranges for both modern cremations (1,000-2,400g, with an average of 1,650g, McKinley 2000, 269) and archaeologically recovered cremation deposits (600-900g, McKinley 2013, 154). Archaeologically recovered deposits of low weight may refer to token deposits (McKinley 2013, 153). However, the present contexts had been heavily truncated (pit 9610 was shallow (0.1m deep) and only the base of the urn was present), making it highly unlikely that this interpretation applies here. Most likely, is that the bone represents a formal urned burial, which had originally comprised a larger quantity of bone, which has been lost as a result of modern disturbance.
- C.2.17 The bones primarily comprised lower limb or limbs, but two fragments of cranial vault were also identified. Together, the material represents at least one older adolescent/adult. No pathology was observed. The fact that the bone was

predominantly from the lower limb may suggest that, following cremation, the remains had been collected from the pyre and placed in the urn in order, from head to toe, the leg/feet being the first to be collected and contained (considering the urn was found sitting on its base, indicating it had not been inverted when buried). Bone fragments showed a low level of fragmentation which is not uncommon for Roman cremation deposits. This suggests limited or no attempt to further fragment the bone following cremation. Fragmentation was, evidently, not considered important.

- C.2.18 Overall, the bones were well burnt, or predominantly white (fully oxidised), indicating pyre temperatures in excess of 600°C (McKinley 2004, 11). This suggests that the corpse (or corpses) had been placed on the pyre in such a way as to maintain a consistent high temperature and oxygen supply (McKinley 2013, 158). A high proportion of fully oxidised bone is a common observation in archaeological cremation burials (McKinley 2006, 84). The presence of grey bone indicates exposure to lower temperatures. This may have been due to a number of reasons, including these areas of the corpse being further away from the heat source or insulated from oxygen and heat because of thicker areas of soft tissue and/or objects/clothing on the corpse (McKinley 1989, 65; McKinley 2013, 158).
- C.2.19 Pyre/grave goods may be indicated by the presence of iron staining and, if identification is confirmed, animal bone and a hob nail. The possible animal bone was burnt, indicating likely placement on the pyre, perhaps as a food offering. The possible hobnail may have been from shoes which had either been worn by the deceased or placed on them on the pyre or in the grave. The provision of footwear with Roman burials is a widely observed funerary rite, associated with the belief that the deceased required footwear to assist them on their journey to the afterlife (Philpott 1991, 173). The iron staining may refer to other grave goods and/or pyre goods.
- C.2.20 The presence of possible pyre goods, coupled with charcoal, suggests that limited or no attempt had been made to exclude pyre debris from the material selected for burial. It could suggest that very little or none of the cremation had been left in situ at the pyre site, or redeposited elsewhere (McKinley, 2013: 153-4).
- C.2.21 The probable loss of bone from truncation means that it is impossible to say how representative these observations - of pyre technology, funerary rite and the skeletal biology - are of the original burial. However, the observations do suggest that in general, the cremation is typical for the Roman period in Britain.

#### **Licence status and retention**

- C.2.22 The assemblage is currently held at Oxford Archaeology under Ministry of Justice burial licence 19-0317. This licence is valid until the 22nd of December 2024. Considering the potential that further works will be undertaken in the area, it is recommended that the assemblage is retained for future research. The licence should therefore be deferred by application to the Ministry of Justice, stating retention in the local receiving museum.

## C.3 Animal Bone

By Lee G. Broderick

### Introduction

- C.3.1 A total of 337 animal bone specimens were recovered from the site (Table 10), most of which were collected by hand. Environmental samples were also taken and were sieved at 10mm, 4mm, 2mm and 0.5mm fractions; a rabbit bone from 8708 and a sheep/goat mandible from 9909 were recovered from the sieved samples. Features on the site were dated on the basis of associated ceramic finds (seriation), mostly to the Romano British period.
- C.3.2 The hand-collected material was recorded in full, with the aid of Oxford Archaeology's skeletal reference collection and standard identification guides, using a diagnostic zone system (Serjeantson 1996). Material recovered from environmental samples was only recorded when it could be identified, following the same criteria.

| Ctxt  | Cut   | Count | Feature Type | Condition | Species      | Element    | Side  | Phase    |
|-------|-------|-------|--------------|-----------|--------------|------------|-------|----------|
| 8708  |       | 1     | Subsoil      | 2         | rabbit       | mandible   | Left  |          |
| 9703  |       | 21    | Colluvium    |           | indet.       | indet.     |       | 40-410   |
| 9903  | 9902  | 1     | Ditch fill   | 3         | Sheep/goat   | mandible   | right |          |
| 9909  | 9905  | 36    | Ditch fill   |           | Large mammal | indet.     |       | 40-410   |
| 9910  | 9905  | 1     | Ditch fill   | 4         | Pig          | radius     | Left  | LBA      |
| 10010 | 10009 | 46    | Ditch fill   |           | Large mammal | indet.     |       | 40-410   |
| 10010 | 10009 | 1     | Ditch fill   | 4         | Cattle       | scapula    | right | 40-410   |
| 10010 | 10009 | 1     | Ditch fill   | 2         | Sheep/goat   | tibia      | right | 40-410   |
| 10010 | 10009 | 1     | Ditch fill   |           | Cattle       | tooth      | Left  | 40-410   |
| 10010 | 10009 | 1     | Ditch fill   |           | Cattle       | tooth      | right | 40-410   |
| 10010 | 10009 | 1     | Ditch fill   | 4         | Cattle       | mandible   | Left  | 40-410   |
| 10010 | 10009 | 1     | Ditch fill   | 4         | Sheep/goat   | femur      | left  | 40-410   |
| 10010 | 10009 | 1     | Ditch fill   | 5         | Pig?         | femur      | right | 40-410   |
| 10016 | 10015 | 1     | Ditch fill   |           | indet.       | indet.     |       |          |
| 10105 | 10104 | 1     | Ditch fill   | 3         | Cattle       | metatarsal | right |          |
| 10203 | 10202 | 143   | Ditch fill   |           | Large mammal | indet.     |       | -100-100 |

| Ctxt  | Cut   | Count | Feature Type | Condition | Species      | Element     | Side | Phase    |
|-------|-------|-------|--------------|-----------|--------------|-------------|------|----------|
| 10203 | 10202 | 1     | Ditch fill   | 4         | Cattle       | femur       | left | -100-100 |
| 10203 | 10202 | 1     | Ditch fill   | 4         | Cattle       | mandible    | left | -100-100 |
| 10203 | 10202 | 1     | Ditch fill   | 4         | Cattle       | mandible    | left | -100-100 |
| 10204 | 10202 | 49    | Ditch fill   |           | Large mammal | indet.      |      | 40-410   |
| 10204 | 10202 | 1     | Ditch fill   | 4         | Cattle       | radius      | left | 40-410   |
| 10204 | 10202 | 1     | Ditch fill   | 3         | Horse        | 1st phalanx |      | 40-410   |
| 11103 |       | 19    | Layer        |           | indet.       | indet.      |      | LBA?     |
| 11811 | 11809 | 6     | Ditch fill   |           | indet.       | indet.      |      | M-LIA?   |

Table 10: Summary of animal bones by context

### Description

C.3.3 Preservation on the site was very mixed, although it tended towards being poor (Figure 28). No doubt this affected the size of the recovered assemblage and also the proportion which could be identified. What could be identified consisted of domestic mammals, with the exception of some small rodent bones which were in noticeably better condition than the rest of the assemblage and are, therefore, probably intrusive and of more recent deposition.

Figure 28. Graph showing condition of identified specimens, expressed as a percentage of NISP (following Behrensmeyer 1978).

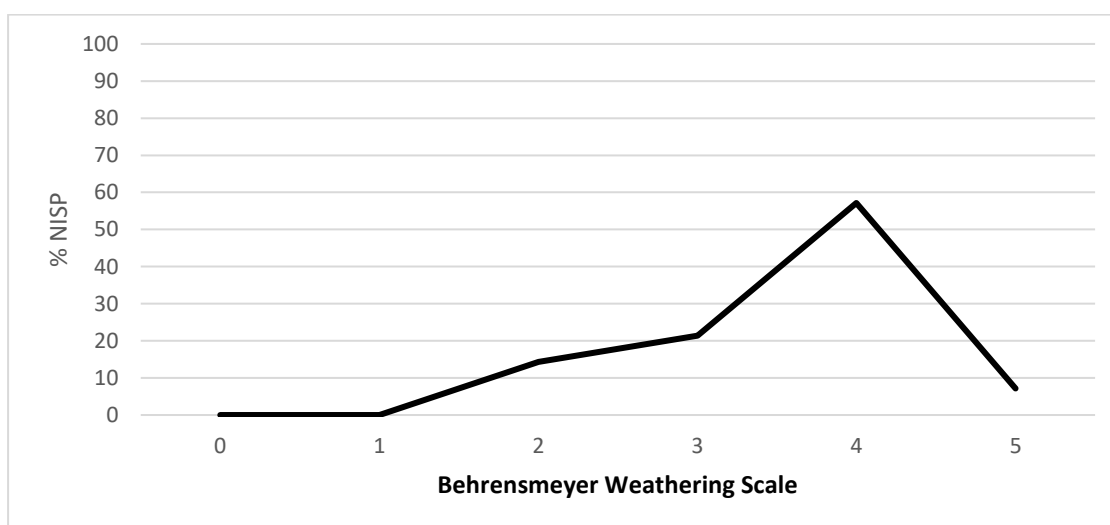

C.3.4 Domestic cattle (*Bos taurus taurus*) was the most common species on the site, with pig (*Sus domesticus*) present in the earliest and latest phases and caprine (sheep [*Ovis aries*] and/or goat [*Capra hircus*]) also present by the latest phase (Table 11).

|                     | LBA | LBA? | M-LIA? | 100BC-AD100 | 40-410 | Undated |
|---------------------|-----|------|--------|-------------|--------|---------|
| domestic cattle     |     |      |        | 3           | 5      | 1       |
| Caprine             |     |      |        |             | 2      | 3       |
| Pig                 | 1   |      |        |             |        |         |
| pig?                |     |      |        |             | 1      |         |
| Horse               |     |      |        |             | 1      |         |
| rabbit              |     |      |        |             |        | 1       |
| large mammal        |     |      |        | 143         | 131    |         |
| <b>Total Mammal</b> | 1   | 0    | 0      | 146         | 140    | 5       |
| <b>Total NISP</b>   | 1   | 0    | 0      | 146         | 140    | 5       |
| <b>Total NSP</b>    | 1   | 13   | 6      | 146         | 161    | 6       |

Table 11: Breakdown of identified bones by species and periods represented

C.3.5 Non-species data was limited (Table 12), with fused longbones epiphyses of pig, domestic cattle and horse demonstrating that adult individuals were present on the site, whilst juvenile domestic cattle are also indicated through the presence of a mandible with the third premolar in wear. A cattle metatarsal from 10105 and a horse phalanx from 10204 have been gnawed by canids, indicating that dogs were also present on the site.

|                 | Butchery marks | Pathologies | Gnawed | Burnt | Ageing data | Biometric data | Sex |
|-----------------|----------------|-------------|--------|-------|-------------|----------------|-----|
| domestic cattle |                |             | 1      |       | 3           |                |     |
| caprine         |                |             |        |       |             |                |     |
| pig             |                |             |        |       | 1           |                |     |
| horse           |                |             | 1      |       | 1           |                |     |
| <b>Total</b>    | 0              | 0           | 2      | 0     | 5           | 0              | 0   |

Table 12: Non-species data recorded from the specimens (NSP) in the assemblage

## Conclusions

C.3.6 Little can be read into such a small assemblage but its size is considerable for an evaluation and a larger excavation is likely to result in a fair sized assemblage. The animal bones should be retained for study alongside bones from further work.

## C.4 Shell

By Geraldine Crann

- C.4.1 Two fragments of oyster shell (*Ostrea edulis*), weighing 17g, including one right valve, were recovered from context 7412.

## Appendix D      References

---

- Anderson-Whymark, H, 2013 The flint, in Allen, T, Barclay, A, Cromarty, A, M, Anderson-Whymark, H, Parker, A, Robinson, M, and Jones, G, *Opening the wood, making the Land; The Archaeology of a Middle Thames Landscape, Mesolithic, Neolithic and Bronze Age*, Oxford Archaeological Unit, Thames Valley Landscapes Monograph **38**.
- Bamford, H, 1985 *Briar Hill: excavation 1974-1978, Northampton*, Northampton Development Corporation. Archaeological monograph **3**
- Barrett, J C, and Bond, D, 1988 Pottery in Bond, *Excavation at the North Ring, Mucking*, East Anglian Archaeology **43**, 25-37, 25-37.
- Booth, P, 2016 Oxford Archaeology Roman pottery recording system: an introduction, unpublished
- Buckley, D, Hedges, J, and Priddy, D, 1987 *Excavation of a Cropmark Enclosure Complex at Woodham Walter, Essex, 1976 and An Assessment of Excavated Enclosures in Essex*, East Anglian Archaeology **33**
- Buikstra, J E and Ubelaker, D H, (eds) 1994 *Standards for Data Collection from Human Skeletal Remains*, Arkansas Archaeological Survey Research Series No **44**
- Bradley, P, 1999 The worked flint in A. Barclay and C. Halpin eds. *Excavations at Barrow Hills, Radley, Oxfordshire*. Oxford: Oxford Archaeological Unit. Thames Valley Landscapes Monograph **11**: 211-227.
- BGS 2019 *Geology of Britain Viewer*. Retrieved from <http://mapapps.bgs.ac.uk/geologyofbritain/home.html>
- Brown, N, 1998 Earlier Iron Age pottery, in G A Carter, *Excavations at the Orsett 'Cock' Enclosure, Essex, 1976*, East Anglian Archaeology **86** , 88-9.
- Chartered Institute for Archaeologists (CIfAa), 2014 *Standard and Guidance for Archaeological Evaluation*. Retrieved from <http://archaeologists.net/sites/default/files/node-files/IfASG-Evaluation.pdf>
- Chartered Institute for Archaeologists (CIfAb), 2014 *Standard and Guidance for the Creation, Compilation, Transfer and Deposition of Archaeological Archives*.
- Dewey, H and Bromehead, C E N, 1915 *The geology of the country around Windsor and Chertsey*, London, H.M. Stationery Office.
- Evans, C, Appleby, G, and Lucy, S, 2016 *Lines in the Land: Mucking Excavations by Margaret and Tom Jones, 1965-1978. Prehistory: context and summary*. Cambridge Archaeological Unit Archives Series: Historiography and Fieldwork 2/Mucking **6**.
- Going, C J, 1987 *The Mansio and other sites in the south-eastern sector of Caesaromagus: The Roman pottery*, CBA Research Report No **62**.



- Harding, P, 1990 The worked flint, in *The Stonehenge environs project*, (ed J C Richards) London, English Heritage
- Healy, F, 1988 *The Anglo-Saxon Cemetery at Spong Hil, North Elmham, Part VI: Occupation during the seventh to second Millennia BC*, East Anglian Archaeology **38**
- Hedges, J. D. and Buckley, D. G. 1978 Excavations at a Neolithic causewayed enclosure, Orsett, Essex, 1975. *Proceedings of the Prehistoric Society* **44**, 219–308
- Highways England 2018 *Lower Thames Crossing: A Scheme Wide Specification for Archaeological Trial Trenching: unpublished document HE540039-CJV-GEN-GEN-SPE-HER-00001draft, Revision 1.05.*
- Historic England 2015 *Management of Research Projects in the Historic Environment: The MoRPHE Project Managers' Guide*. Swindon: Centre for Archaeology Guidelines.
- Inizan, M-L, Reduron-Ballinger, M, Roche, H and Tixier, J, 1999 *Technology and terminology of knapped stone*, Cercle de Recherches et d'Etudes Préhistoriques, CNRS, Nanterre
- Lavender, N J, 1998 Prehistoric and Roman-British Activity at the William Edwards School, Stifford Clays Road, Grays; excavations 1997, *Essex Archaeology and History* **29**, 19-32
- Lucy, S, and Evans, C, 2016 *Romano-British Settlement and Cemeteries. Mucking Excavations by Margaret and Tom Jones, 1965-1978*. Oxford: Oxbow
- McKinley, J I, 1989 Cremations: expectations, methodologies and realities. In C Roberts, F Lee and J Bintliff (eds) *Burial Archaeology – Current Research, Methods and Developments*, BAR Report **211**, Oxford
- McKinley, J I, 2000 Cremation burials in B Barber and D Bowsher, *The Eastern Cemetery of Roman London. Excavations 1983-1990*, MoLAS Monograph **4**, 264-277
- McKinley, J I, 2004 Compiling a skeletal inventory: cremated human bone, in: M Brickley and J I McKinley (eds.), *Guidelines to the Standards for Recording Human Remains*, IFA Paper No. **7**, BBAO and IFA: Southampton and Reading: 9-13
- McKinley, J I, 2006 Cremation...the cheap option? In C Knusel and R Gowland (eds) *The Social Archaeology of Funerary Remains*, Oxbow Books, Oxford: 81-8.
- McKinley, J I, 2013 Cremation: excavation and analysis. In S Tarlow and L Nilsson Stutz (eds) *The Oxford Handbook of the Archaeology of Death and Burial*, 147-72, Oxford, Oxford University Press
- McKinley, J I, and Roberts, C, 1993 *Excavation and Post-excavation Treatment of Cremated and Inhumed Human Remains*, IFA Technical Paper **13**, Reading

- Medlycott, M ed., 2011 *Research and Archaeology Revisited: A Revised Framework for the East of England*, East Anglian Archaeology Occasional Paper **24**: Association of Local Government Archaeological Officers.
- Onhuma, K and Bergman, C A, 1982 Experimental studies in the determination of flake mode, *Institute of Archaeology Bulletin*, London **19**, 161-171
- Oxford Archaeology, 2019a *Lower Thames Crossing Scheme-wide Written Scheme of Investigation for Trial Trenching south of the River Thames*.
- Oxford Archaeology 2019b *Lower Thames Crossing Scheme-wide Written Scheme of Investigation for Trial Trenching north of the River Thames*.
- Oxford Archaeology 2019c *Lower Thames Crossing Detailed Written Scheme of Investigation for Trial Trenching of Land Parcel 21*. Oxford Archaeology.
- Oxford Cotswold Archaeology 2020a *Lower Thames Crossing: Evaluation report for Archaeological Trial Trenching in Land Parcel 3, Hornsby Lane and Heath Place*, unpublished document HE540039-CJV-GEN-GEN-REP-GEO-00025
- Oxford Archaeology 2020b *Lower Thames Crossing: Archaeological Evaluation report for Trial Trenching of Land Parcel 22, Whitfield South Scheduled Monument Complex, South of Stifford Clays Road, Baker Street, Essex*, unpublished document HE540039-CJV-GEN-GEN-REP-GEO-00026
- PCRG, SGRP, MPRG, 2016 A standard for pottery studies in archaeology, Prehistoric Ceramics Research Group, Study Group for Roman Pottery, and the Medieval Pottery Research Group
- Philpott, R. 1991. *Burial Practices in Roman Britain. A Survey of Grave Treatment and Furnishing A.D. 43-410*. BAR British Series **219**, Tempus Reparatum, Archaeological and Historical Associates.
- Place Services, 2019 *Lower Thames Crossing Aerial Investigation and Mapping Report, Essex County Council*.
- Saville, A, 1980 *On the measurement of struck flakes and flake tools*, *Lithics* **1**, 16-20.
- Serjeantson, D, 1996 Animal Bone. In: Needham, S. and Spence, T. (eds) *Runnymede Bridge Research Excavations, Volume 2: Refuse and Disposal at Area 16 East, Runnymede*. 194–223.
- Scheuer, L and Black, S, 2000 *Developmental Juvenile Osteology*, Academic Press: London
- Tomber, R, and Dore, J, 1998 *The National Roman Fabric Reference Collection: a handbook*, MoLAS Monograph **2**, London
- Wilkinson, T J, 1988 *Archaeology and Environment in South Essex: Rescue Archaeology on the route of the A13 Grays By-pass, 1979/80*. East Anglian Archaeology **42**.

## Appendix E      Abbreviations and Glossary

---

**ADS** Archaeology Data Service. Digital archaeological archive

**CDM** Construction Design Manual. Health and safety guidance for the construction industry

**CPD** Continuing Professional Development

**CIfA** Chartered Institute for Archaeologists

**DBA** Desk Based Assessment. Detailed assessment of archaeology and other aspects of the historic environment

**DCO** Development Consent Order

**EIA** Environmental Impact Assessment. Detailed study of environmental impacts as directed under the The Town and Country Planning (Environmental Impact Assessment) Regulations 2017 following on from EU Directive EIA Directive (85/337/EEC)

**ES** Environmental Statement. The principal environmental report detailing environmental impacts within an EIA

**GPS** Global Positioning System

**HER** Historic Environment Record

**LTC** Lower Thames Crossing

**MCIfA** Member of the Chartered Institute for Archaeologists

**MoRPHE** Management of Research Projects in the Historic Environment

**NMP** National Mapping Programme. A study of aerial photographs and digitisation of resulting data into GIS. Originally funded by Historic England

**OASIS** Online Access to the Index of archaeological investigations.  
The OASIS project brings together a number of strategic partners: the Archaeology Data Service, Historic England, Historic Environment Scotland, and the Royal Commission on the Ancient and Historical Monuments of Wales under the umbrella of the University of York

**OCN** Old County Number. Historic England's reference for material that is not readily-available online and may represent historic archaeological work that consists of paper archives or has yet to be formally reported on

**PINS** Planning Inspectorate

**RAMS** Risk Assessment Method Statement

**SMC** Scheduled monument consent

**TDR** Trusted Digital Repository

**UKIC** United Kingdom Institute for Conservation

**WSI** Written Project of Investigation. A detailed method statement for archaeological work

**WSL** – Western Southern Link  
The Western Southern Link (WSL) is an alternative for Short List Routes 2, 3 and 4 to the south of the River Thames.

## Appendix F Site Summary

---

|                           |   |
|---------------------------|---|
| <b>Site name:</b>         | Lower Thames Crossing Land Parcel 21<br>North of Stifford Clays Road, Baker Street, Essex |
| <b>Site code:</b>         | LTC21W19  |
| <b>Grid Reference</b>     | NGR 562736 181588   |
| <b>Type:</b>              | Evaluation  |
| <b>Date and duration:</b> | Six weeks, from 4th February - 18th March 2020  |
| <b>Area of Site</b>       | 23.66ha   |

### Location of archive:

The archive from Land Parcel 21 will form part of the overall trial trenching scheme archive. This will be deposited in a repository consistent with the standards required by the Museums and Galleries Commission following completion of the archaeological phase of this project. This may either be with the local receiving museum in Thurrock or, if no such repositories are available, with a repository for the whole project designated by LTC. LTC retain the overall responsibility for the successful deposition of the project archive.

Currently, the archive is held at Oxford Archaeology's head office, Janus House, Osney Mead, Oxford, Oxfordshire, OX2 0ES. Oxford Archaeology will store the archive for LTC for a maximum period of 2 years following the completion of the project. If arrangements for the deposition of the archive have not been completed by this time, an extension to the storage period and final deposition timetable will be reviewed by OA and LTC and agreed with the Key Archaeological Stakeholders.

### Summary of Results:

Oxford Cotswold Archaeology was commissioned by Balfour Beatty to undertake a trial trench evaluation of Land Parcel 21 of the Lower Thames Crossing Pre-Enabling Works. Land Parcel 21, also known as Whitfield North, is located c 600m WNW of the village of Baker Street within the county of Essex and Thurrock unitary authority (NGR 562736 181588). The evaluation comprised 128 trenches and was completed between the 4th February and the 18th March 2020.

Due to unforeseen constraints, including localised flooding, only 116 of the 128 trenches could be excavated. Of these, a total of 46 trenches revealed features of archaeological significance. These features were predominantly situated on the higher elevations along the southern limit of the site, coinciding with the geology of Boyn Hill sand and gravels, although some isolated activity was also present further north on the clay and silt head deposits.

The earliest activity was represented by a small assemblage of struck flint, which included pieces of Mesolithic or early Neolithic date and other tools of later Neolithic or early Bronze Age date. There were no features dated to these periods found in the evaluation. The only possible evidence for later Bronze Age activity was a single sherd of late Bronze Age or early Iron Age pottery, and none of the struck flints appeared to be of this date.

At the south end of the site enclosure ditches of middle Iron Age date were found, and although not directly dated, several penannular gullies are likely to be of similar date. In the late Iron Age to early Roman period settlement activity intensified, and continued throughout the Roman period, though tailing off in the late Roman period.

North of this lines of parallel slots, vertical-sided and flat-bottomed with deliberate backfills, some containing Roman pottery, were found running east-west in two parts of the field, and these may represent associated agricultural activity of Roman date.

No activity of Saxon or medieval date was found on the site. Post-medieval field boundaries were encountered in the north, central and south-eastern parts of the site, together with a post-medieval pit at the south-east end of the site.

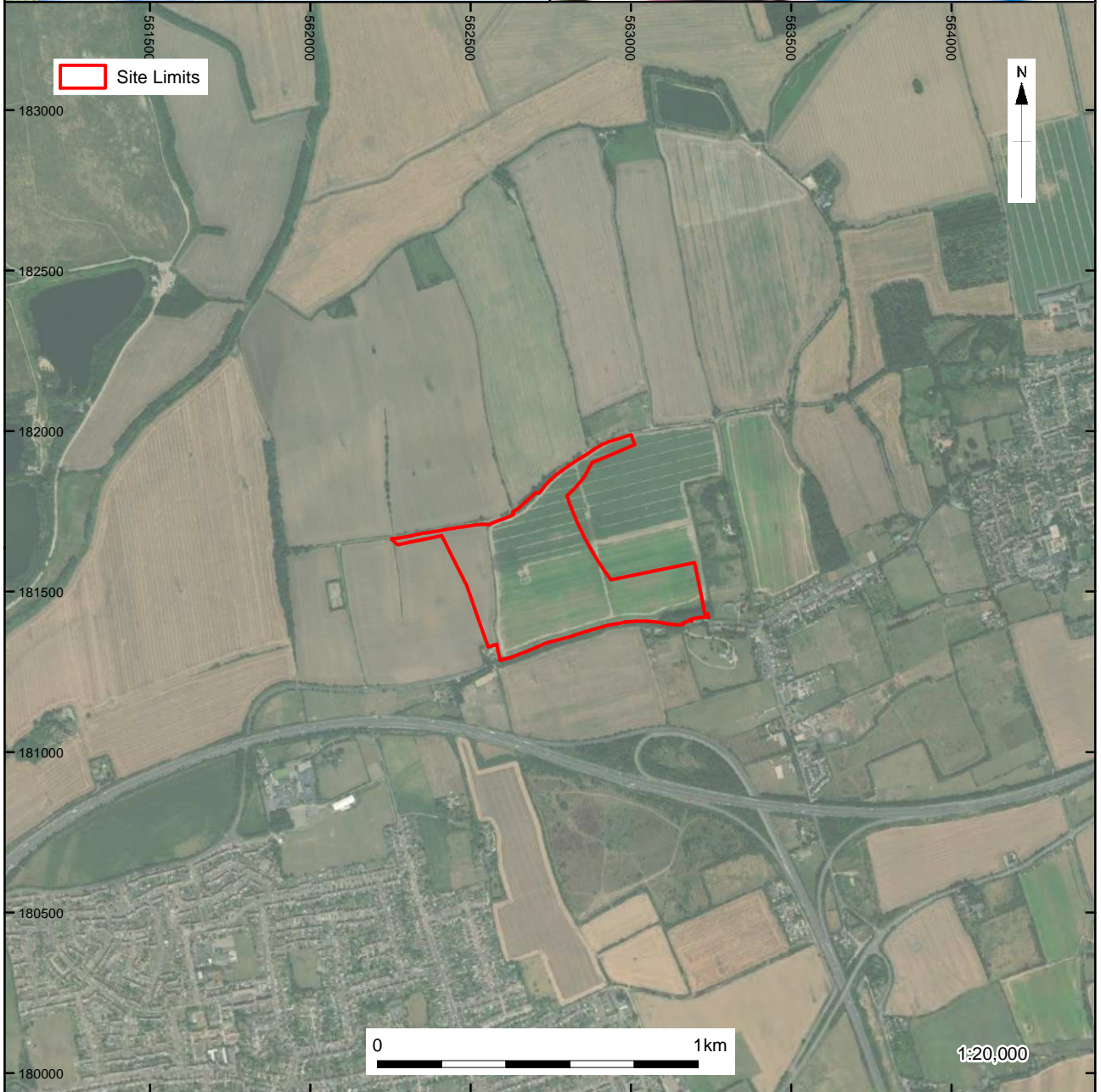
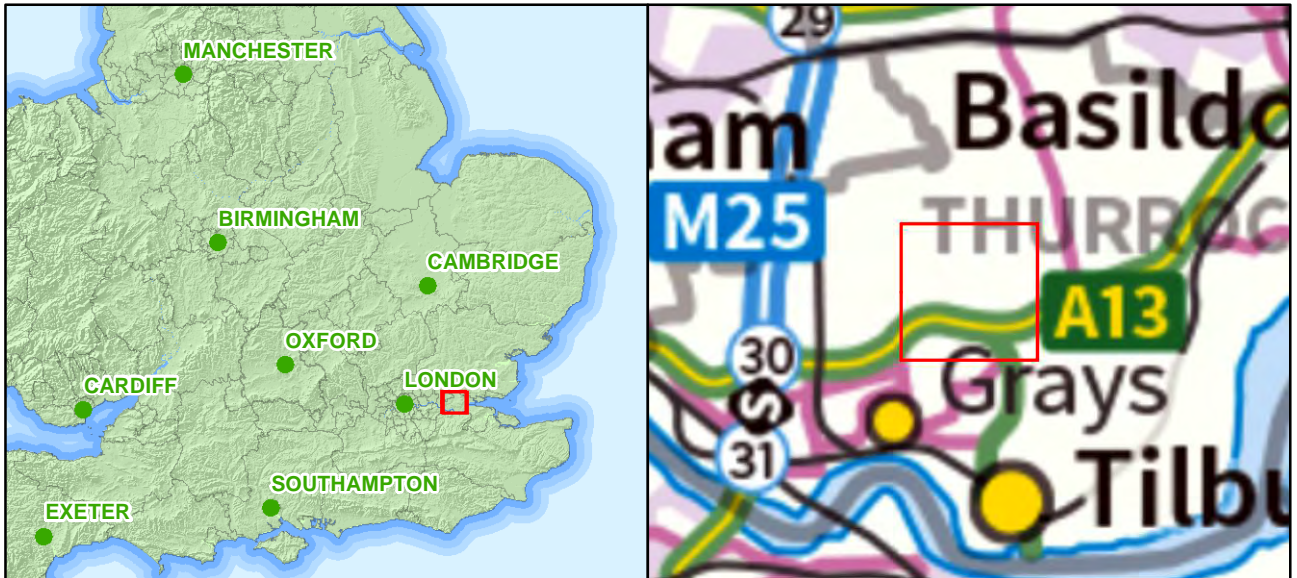

Source: Esri, Maxar, GeoEye, Earthstar Geographics, CNES/Airbus DS, USDA, USGS, AeroGRID, IGN, and the GIS User Community

Figure 1: Map showing the location of Land Parcel 21

X:\NL\TOEV\_Lower\_Thames\_Crossing\010\Geomatics\03 GIS Projects - L\TC21W19\Figures\Re-names for TimL\TC21W19\_Fig1.mxd\*aidan.faman\*21/08/2020

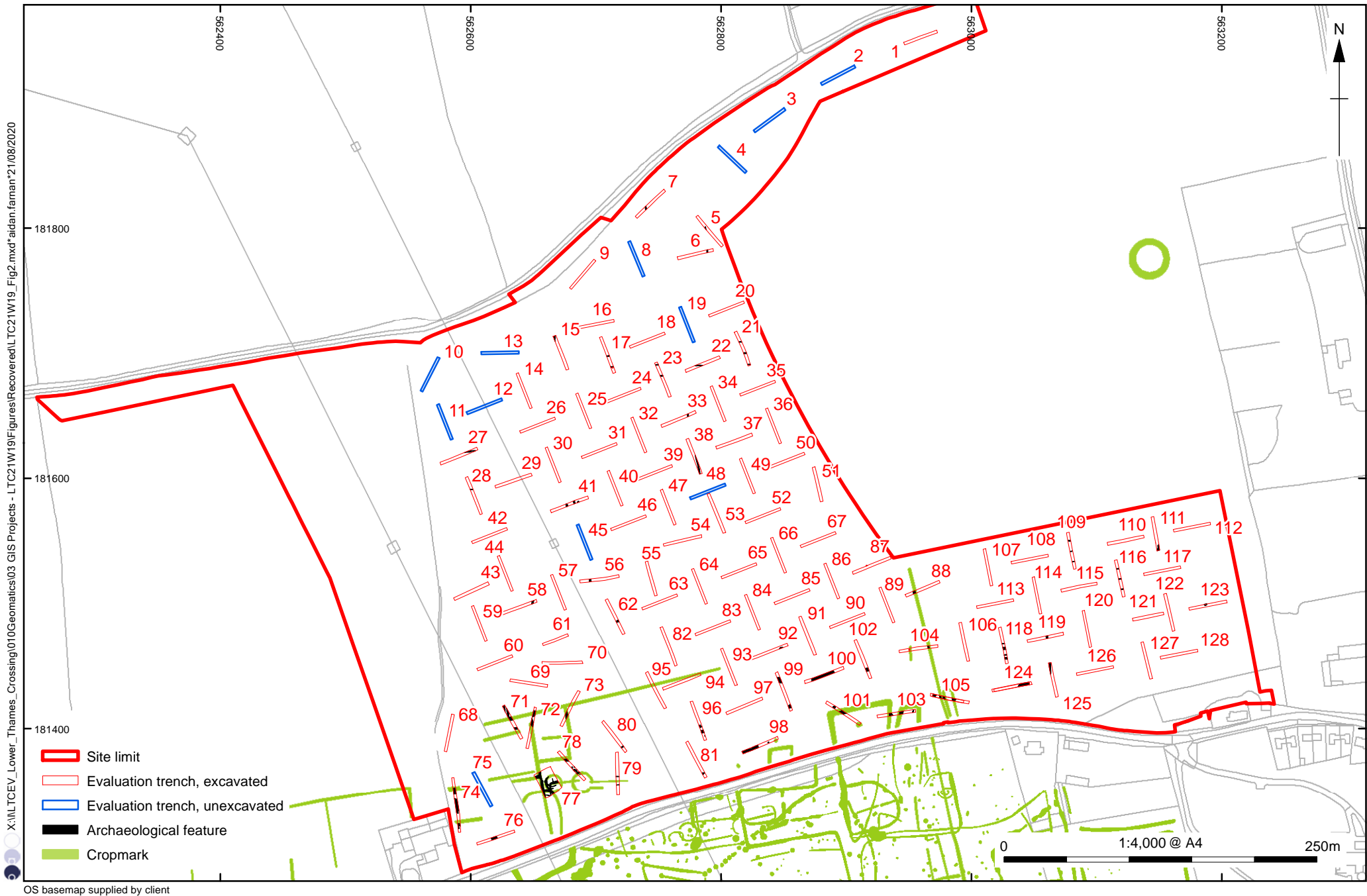

Figure 2: Plan of trenches, cropmark features and archaeological features

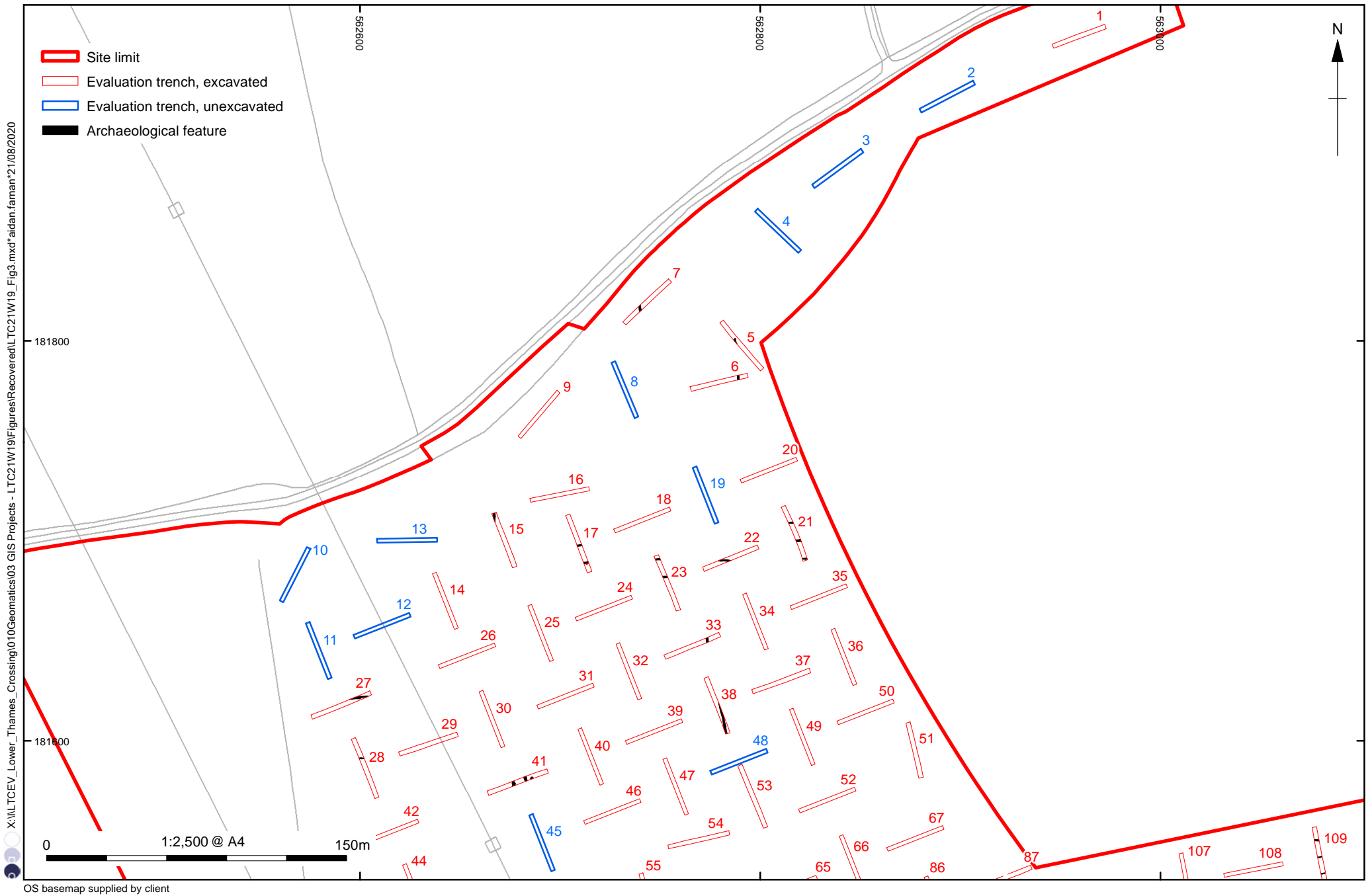

Figure 3: Detailed overview of north half of site



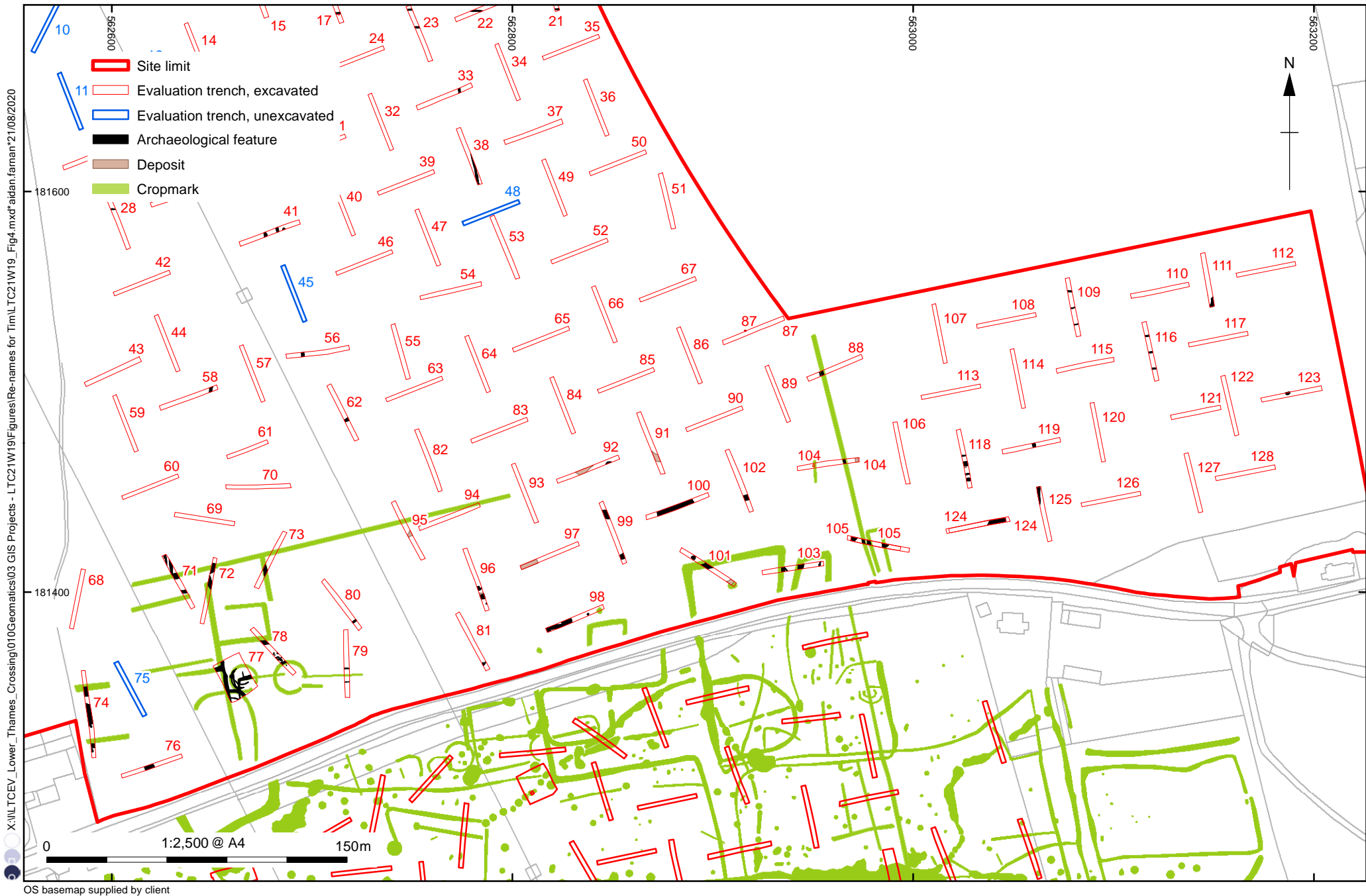
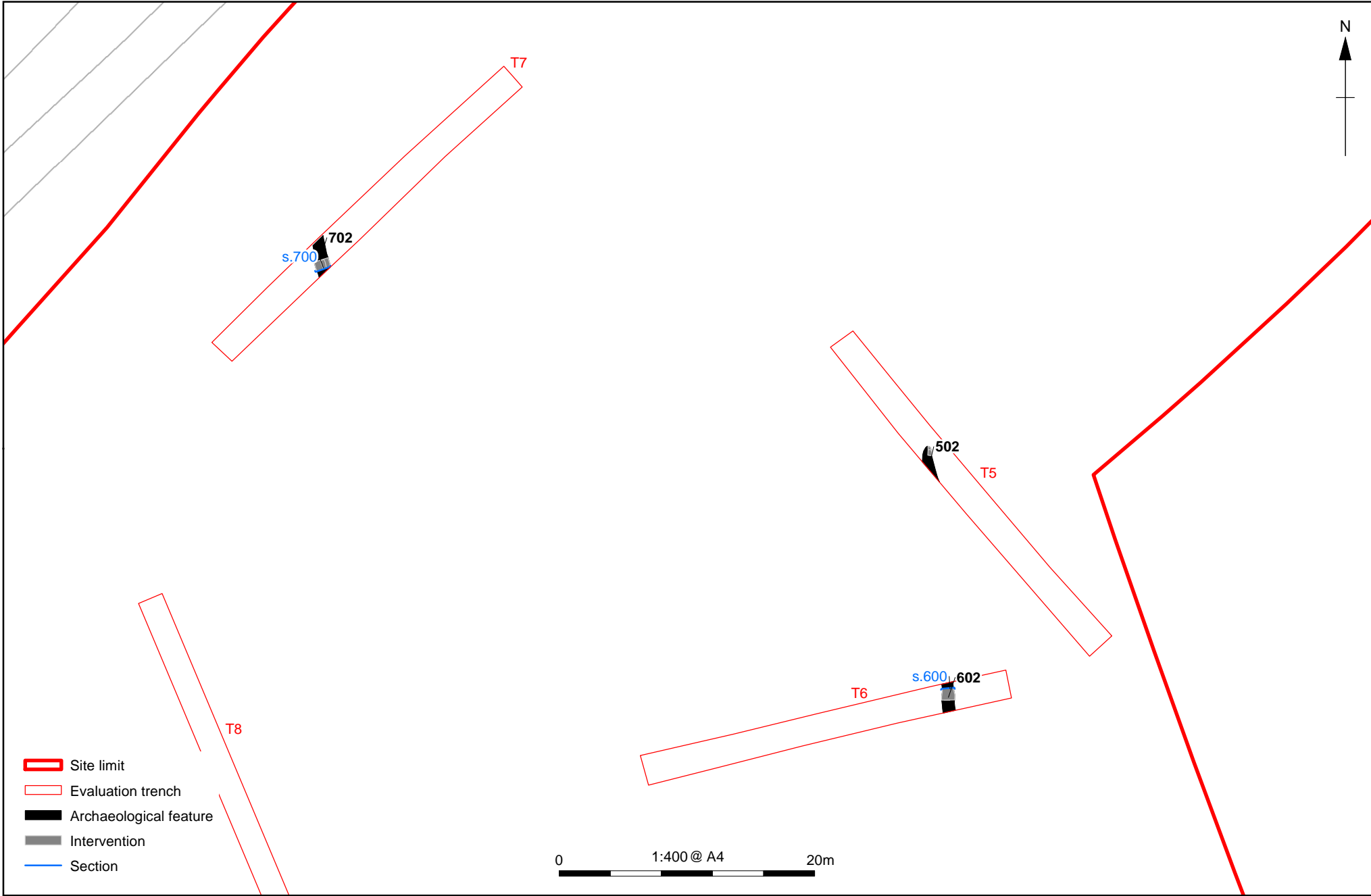

Figure 4: Detailed overview of south half of site

X:\MLTCEV\_Lower\_Thames\_Crossing\010Geomatics\03 GIS Projects - LTC21W19\Figures\Re-names for Tim\TLC21W19\_Fig5.mxd\*aidan.farman\*21/08/2020



OS basemap supplied by client

Figure 5: Plan of Trenches 5-7

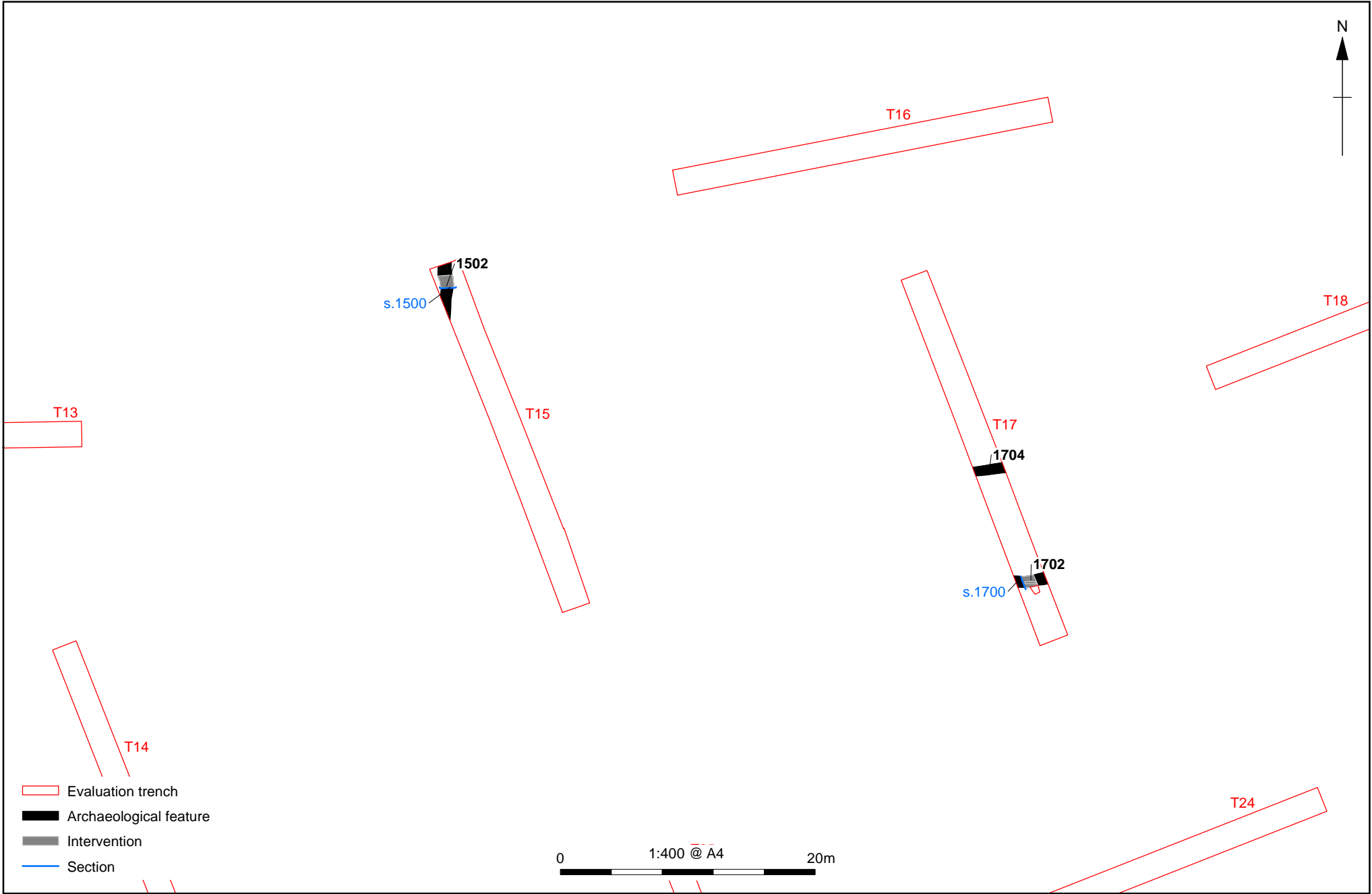

Figure 6: Plan of Trenches 15-17

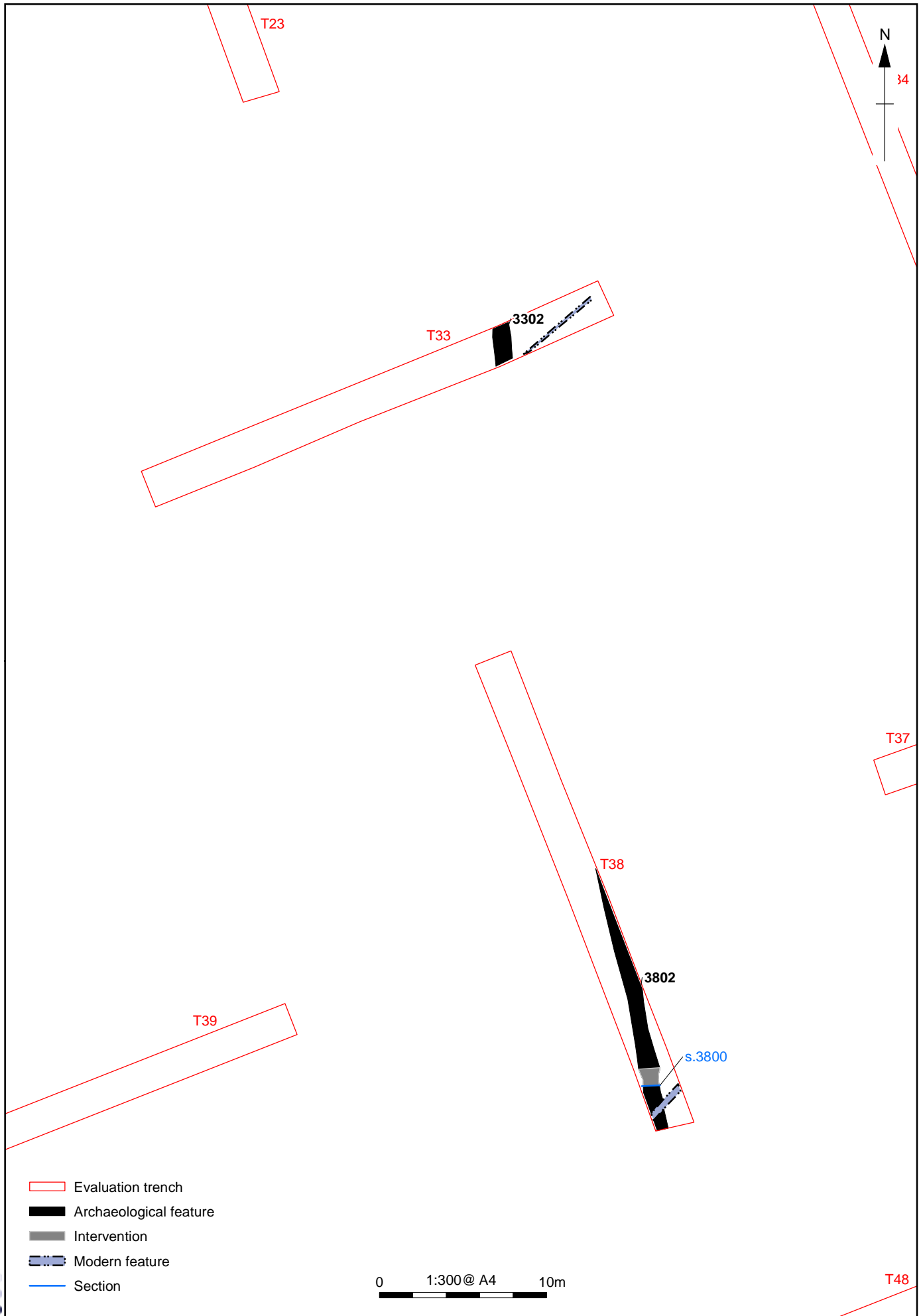

Figure 7: Plan of Trenches 33 and 38

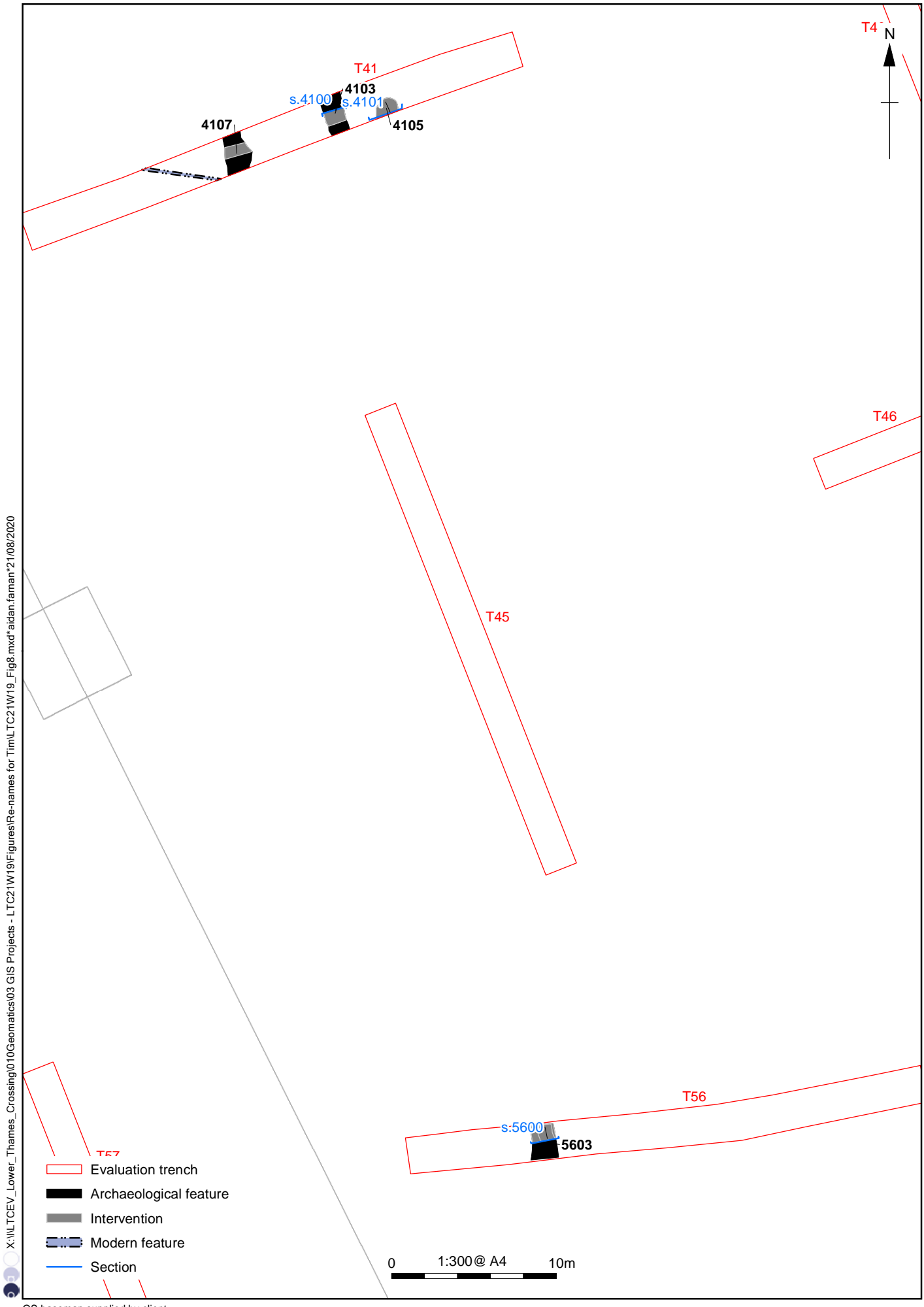

Figure 8: Plan of Trenches 41 and 56

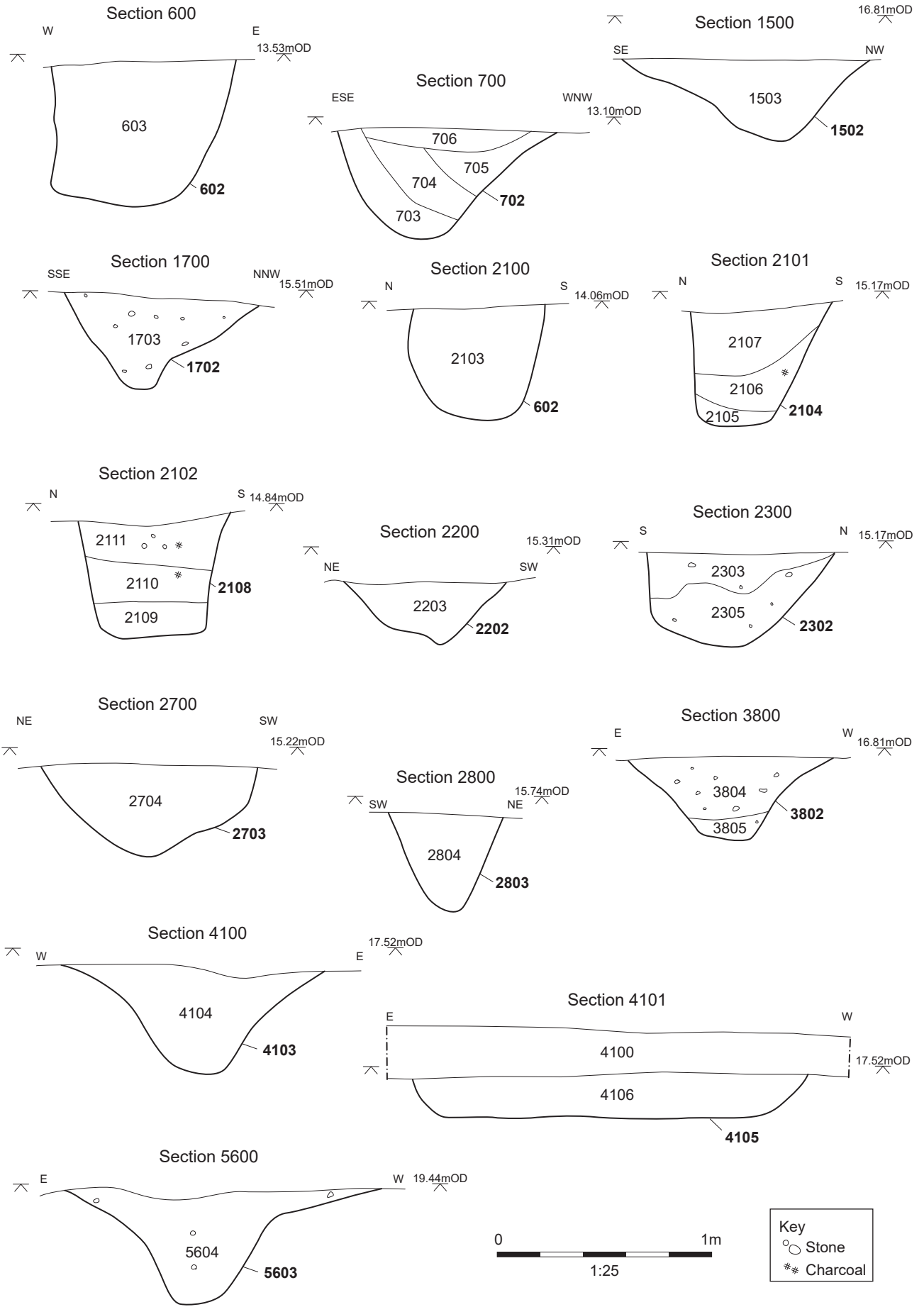

Figure 9: Sections (Trenches 6, 7, 15, 17, 20, 21-23, 27, 28, 38, 41 and 56)

X:\MLTCEV\_Lower\_Thames\_Crossing\010Geomatics\03 GIS Projects - LTC21W19\Figures\Re-names for Tim\TTC21W19\_Fig10.mxd\*aidan.farman\*21/08/2020

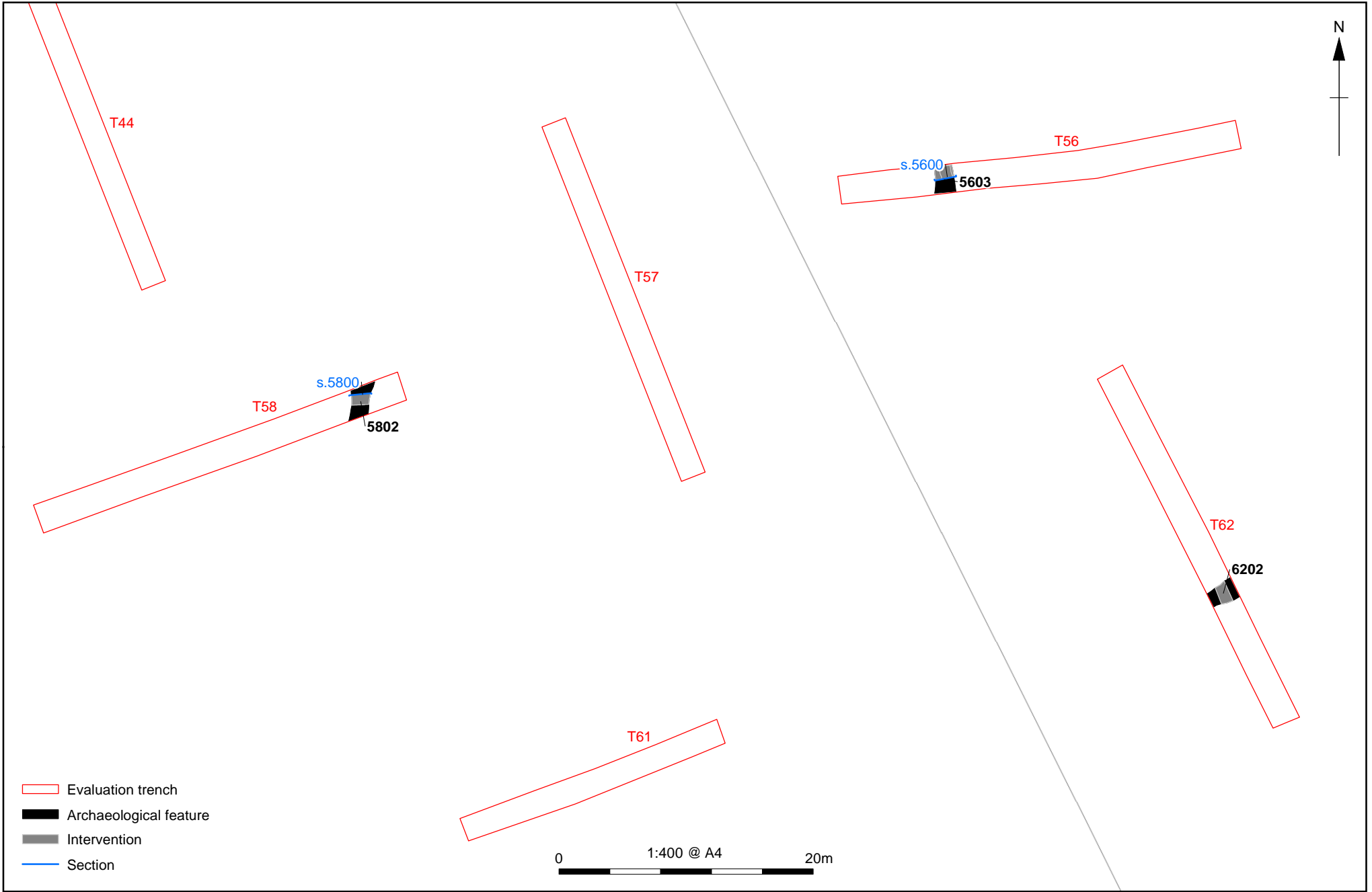

Figure 10: Plan of Trenches 56-58 and 61-62

X:\MLTCEV\_Lower\_Thames\_Crossing\010Geomatics\03 GIS Projects - LTC21W19\Figures\Re-names for Tim\T21W19\_Fig11.mxd\*aidan.farman\*21/08/2020

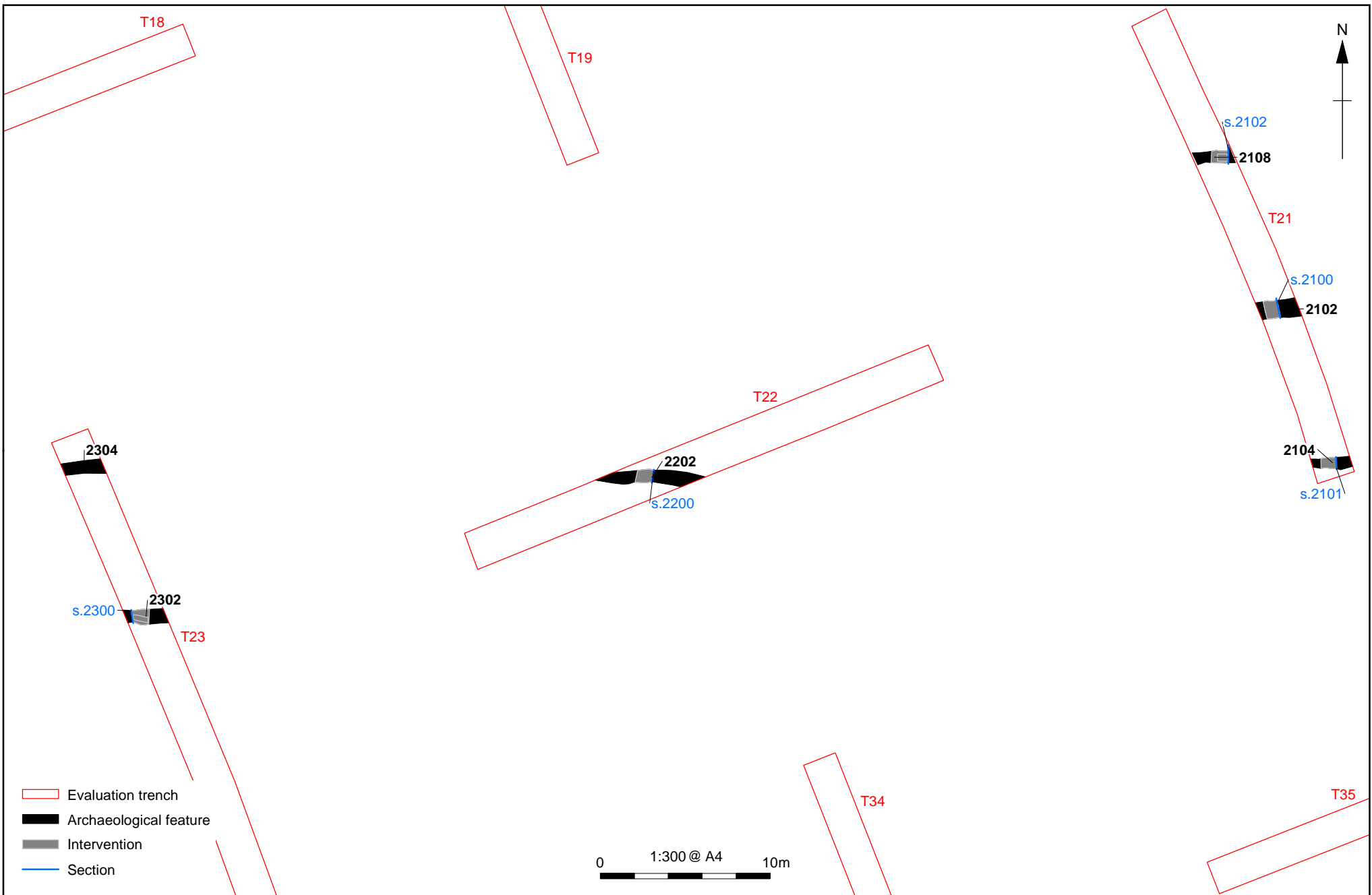

Figure 11: Plan of Trenches 21-23



X:\M\TCEV\_Lower\_Thames\_Crossing\010\Geomatics\03 GIS Projects - LTC21W19\Figures\Re-names for TimLTC21W19\_Fig12.mxd\aidan.faman\21/08/2020

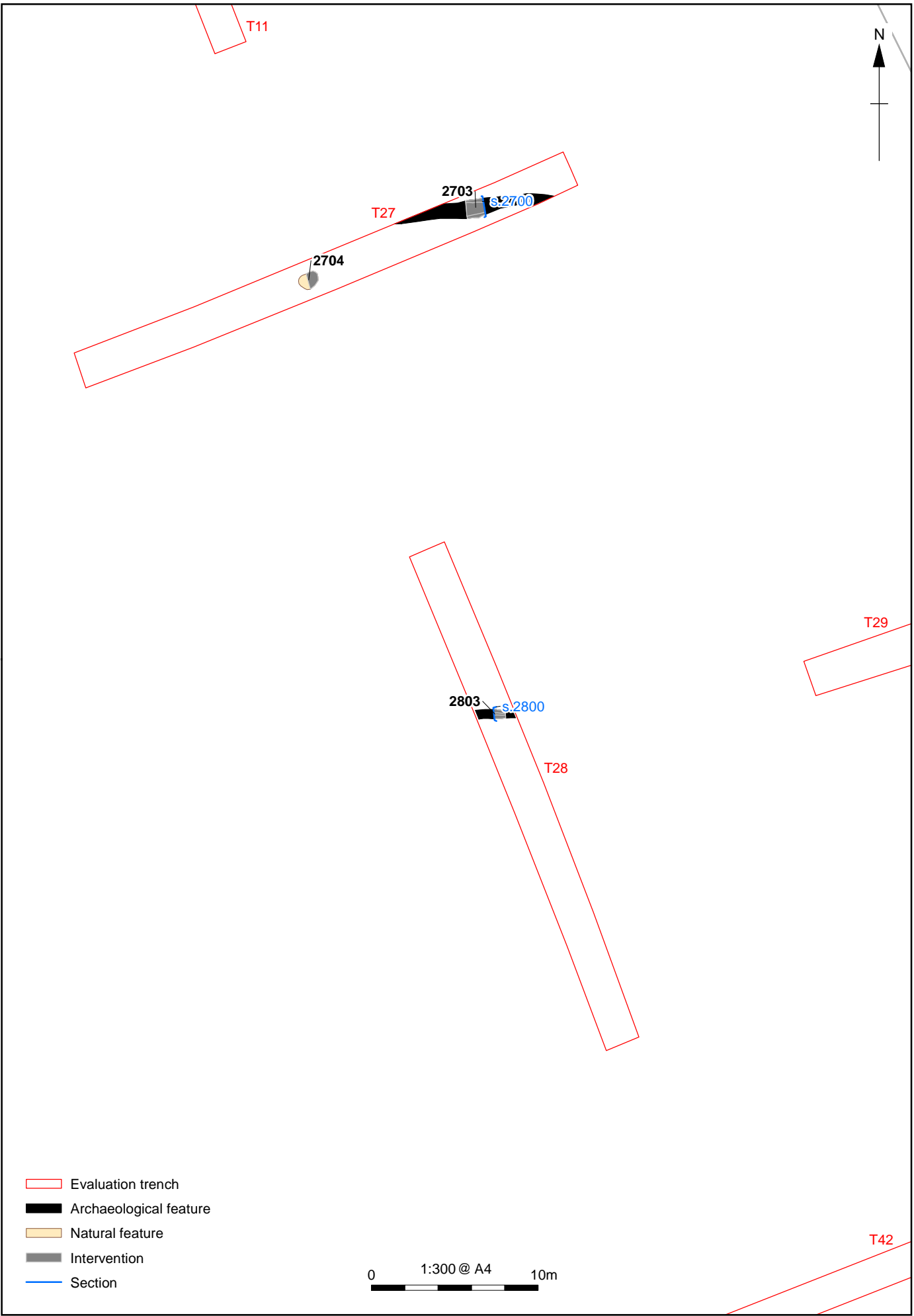
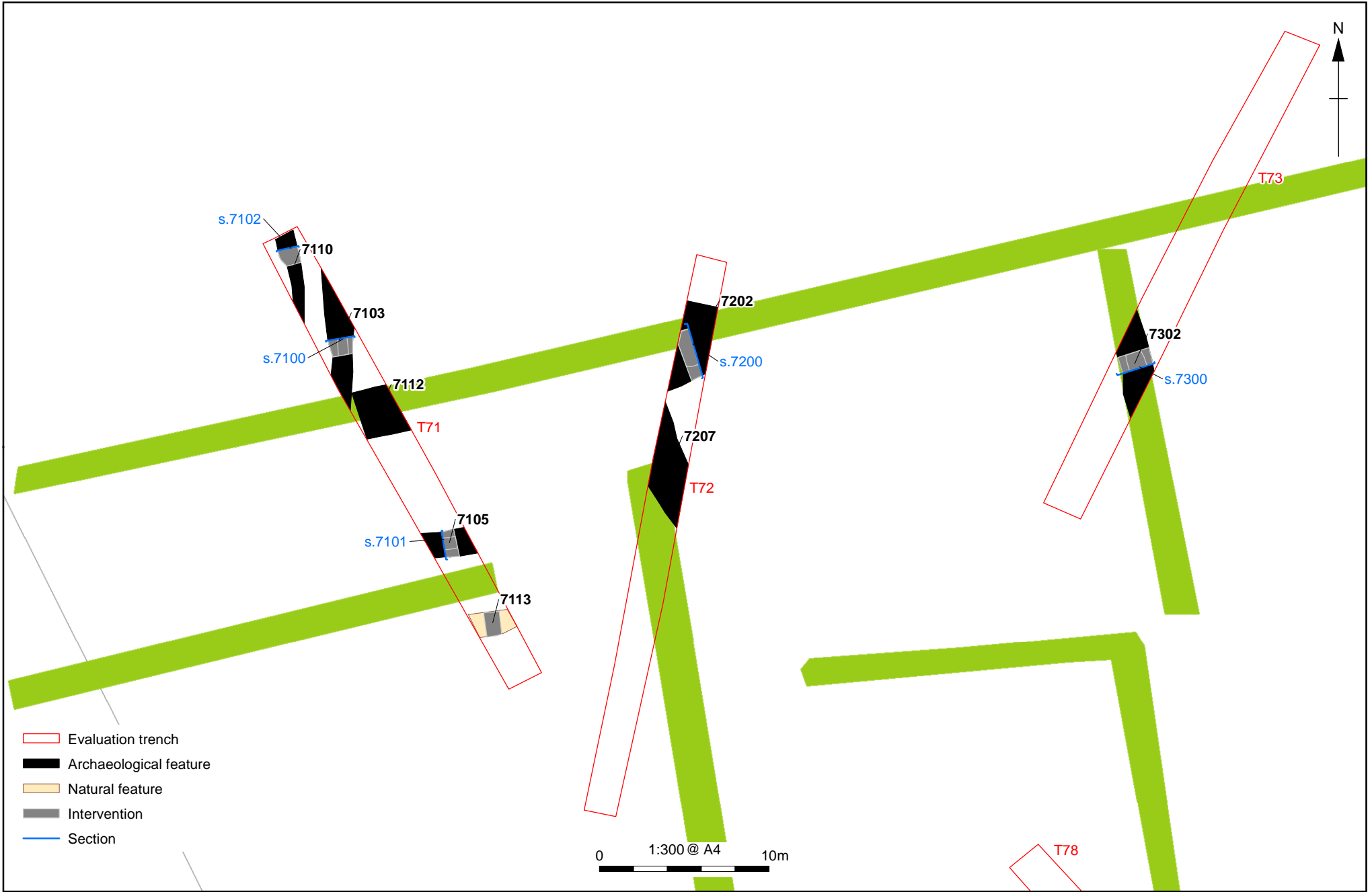

Figure 12: Plan of Trenches 27-28



OS Masemap provided by client

Figure 13: Plan of Trenches 71-73

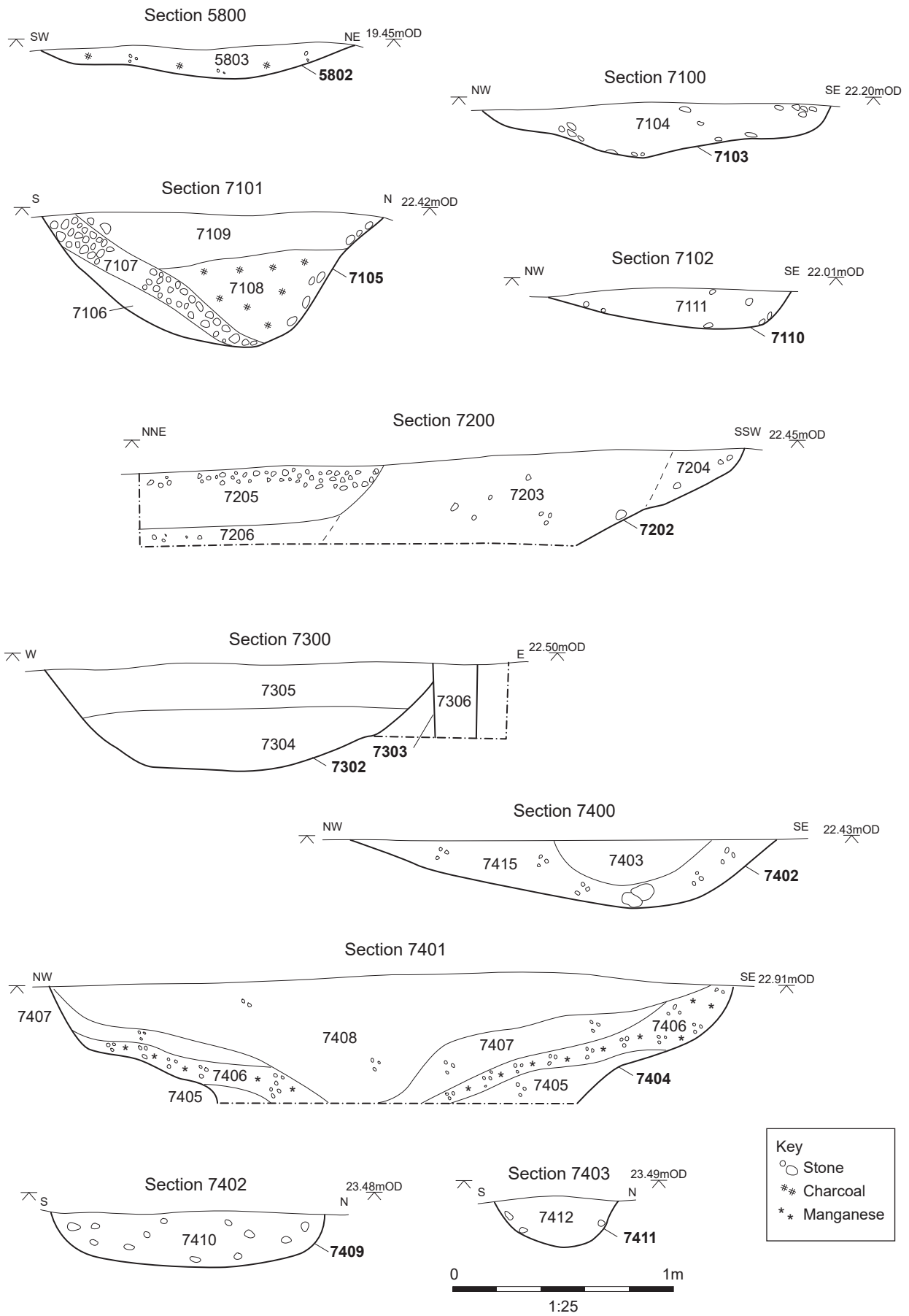
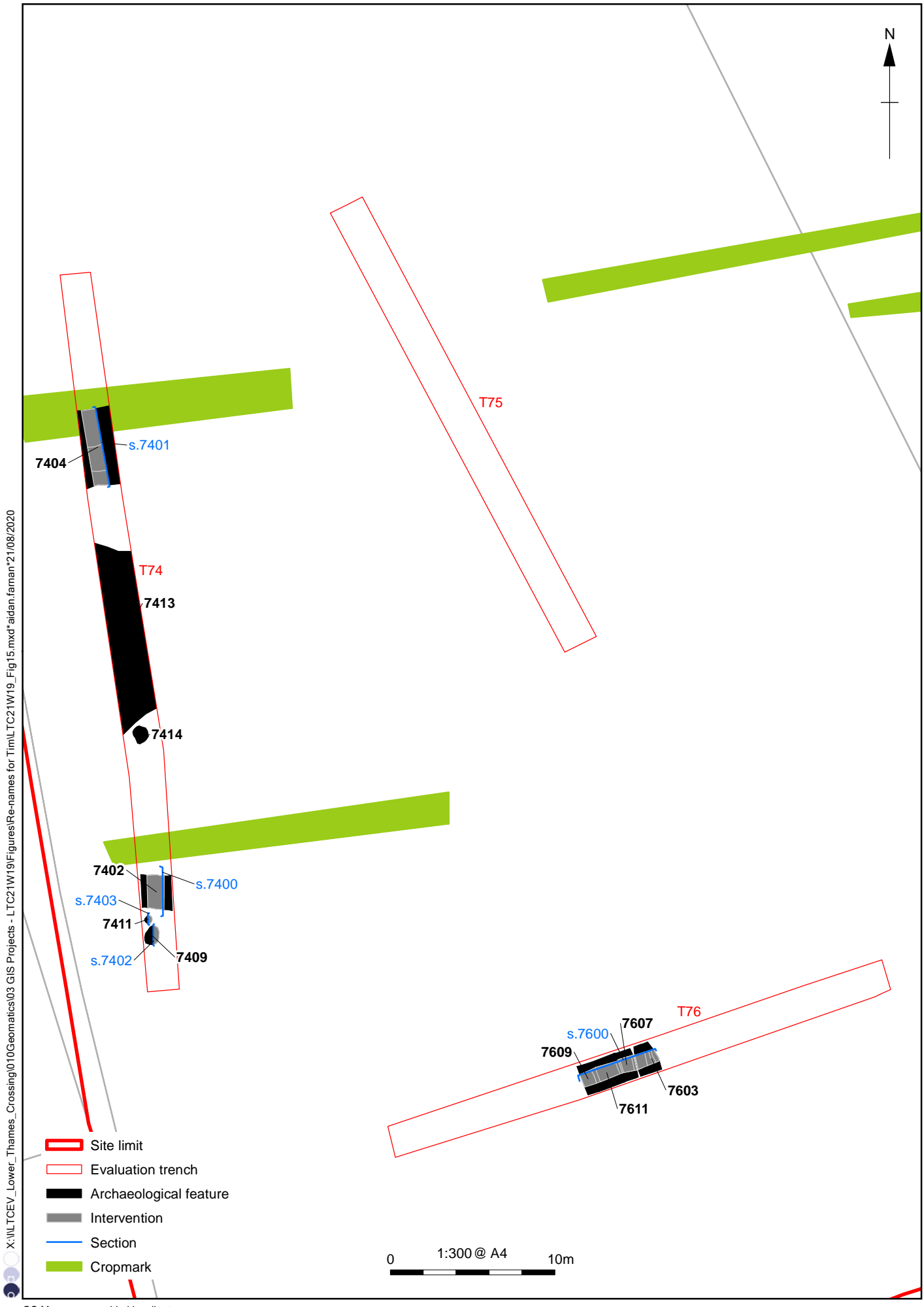
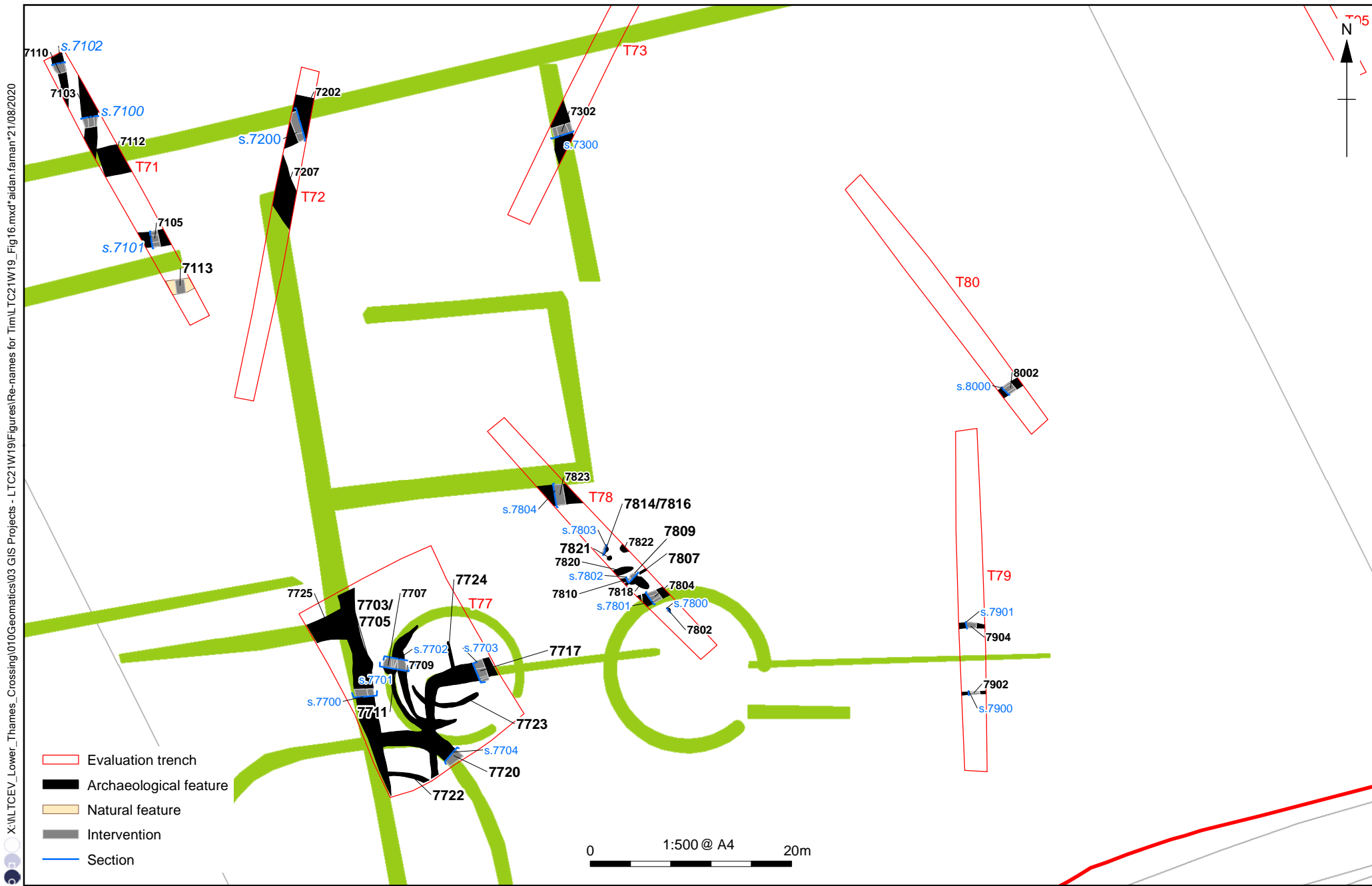

Figure 14: Sections (Trenches 58, 71, 72, 73 and 74)



OS Masemap provided by client

Figure 15: Plan of Trenches 74-76



X:\MLTCEV\_Lower\_Thames\_Crossing\010Geomatics\03 GIS Projects - LTC21W19\Figures\Re-names for Tim\TLC21W19\_Fig16.mxd\aidan.farnan\*21/08/2020

OS Masemap provided by client

Figure 16: Plan of Trenches 77-80 and 72

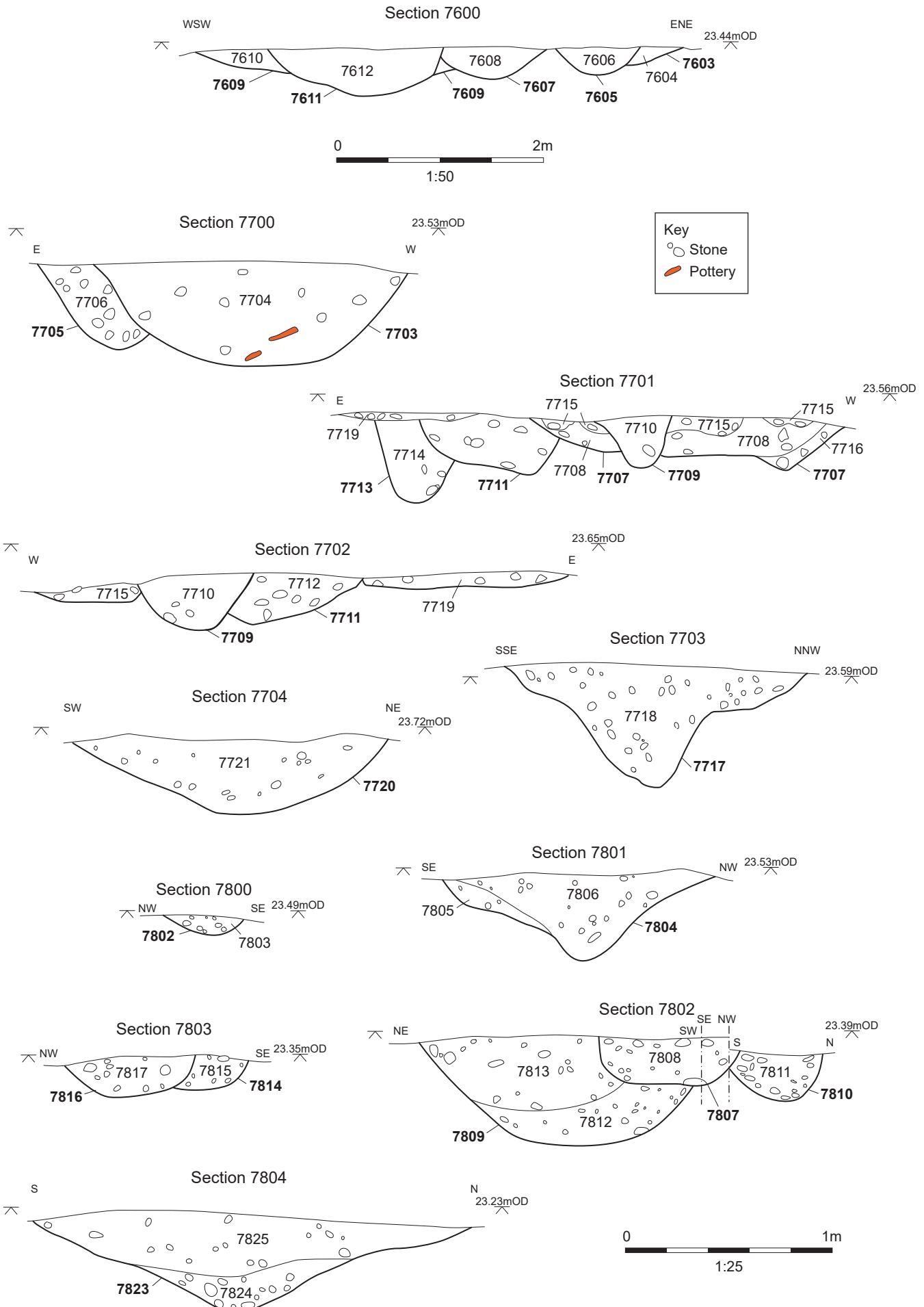
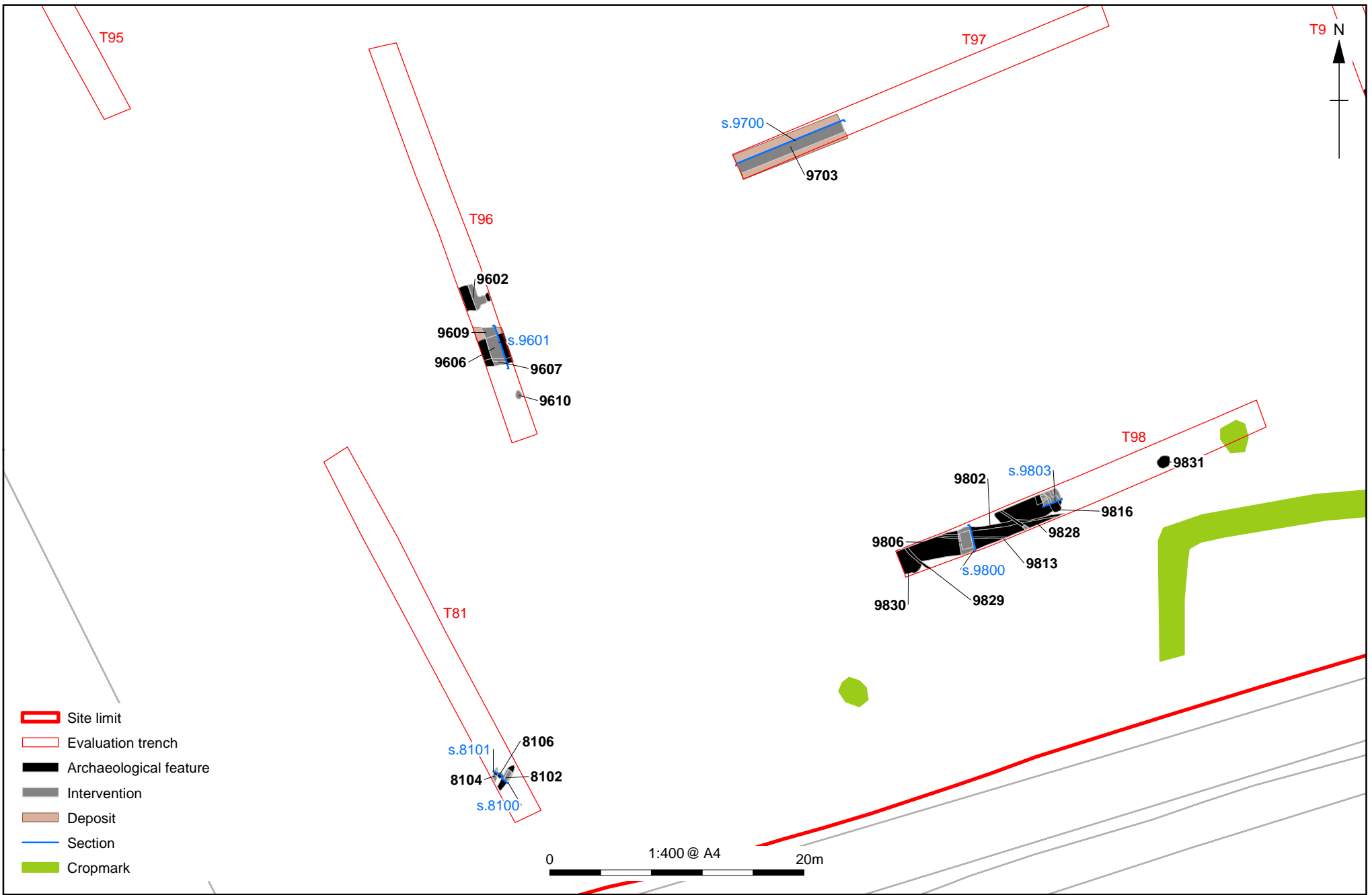

Figure 17: Sections (Trenches 76, 77 and 78)

X:\MLTCEV\_Lower\_Themes\_Crossing\010Geomatics\03 GIS Projects - LTC21W19\Figures\Re-names for Tim\TTC21W19\_Fig18.mxd\*aidan.farman\*21/08/2020



- Site limit
- Evaluation trench
- Archaeological feature
- Intervention
- Deposit
- Section
- Cropmark

0 1:400 @ A4 20m

OS Masemap provided by client

Figure 18: Plan of Trenches 81 and 96-98

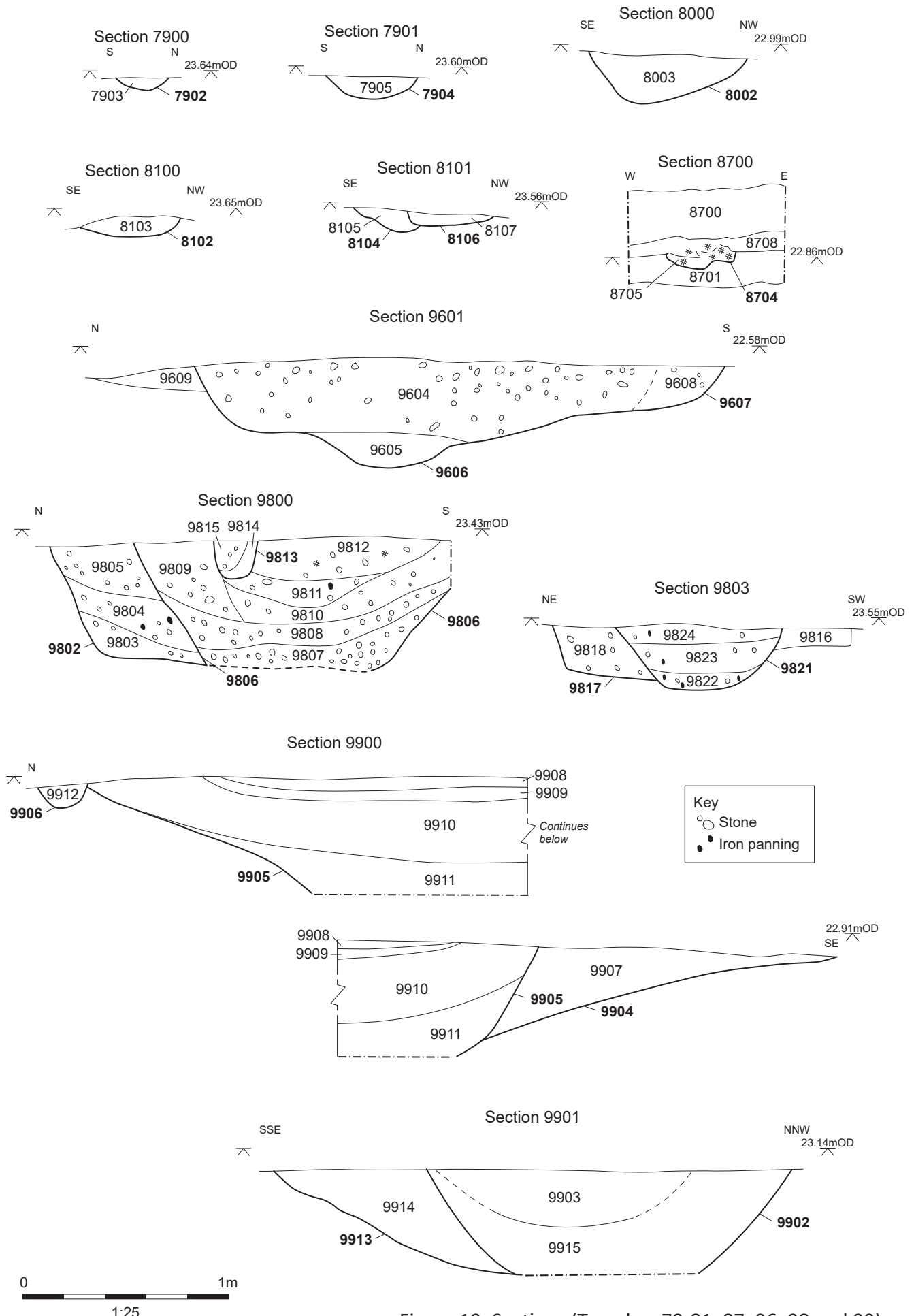

Figure 19: Sections (Trenches 79-81, 87, 96, 98 and 99)



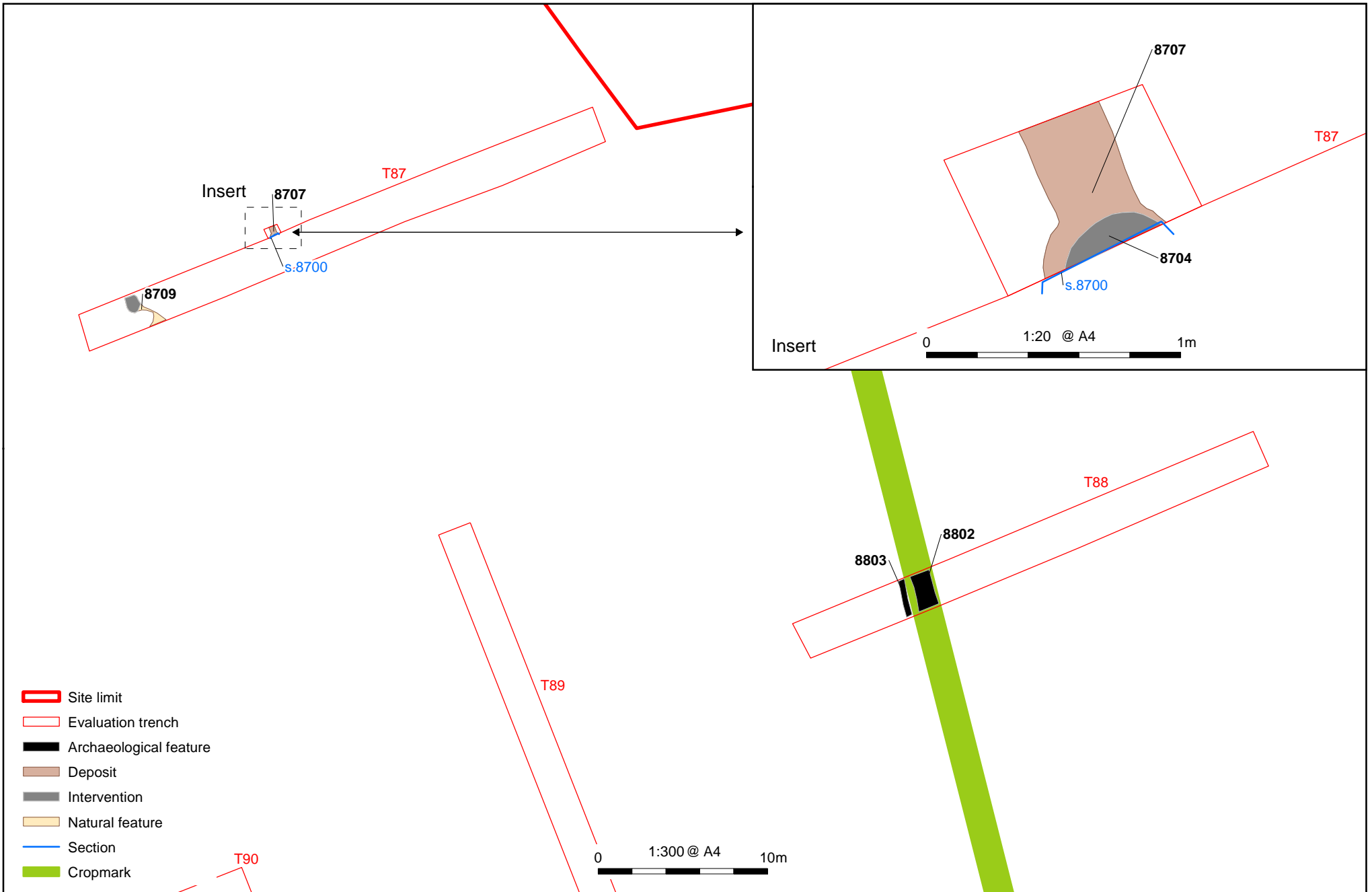
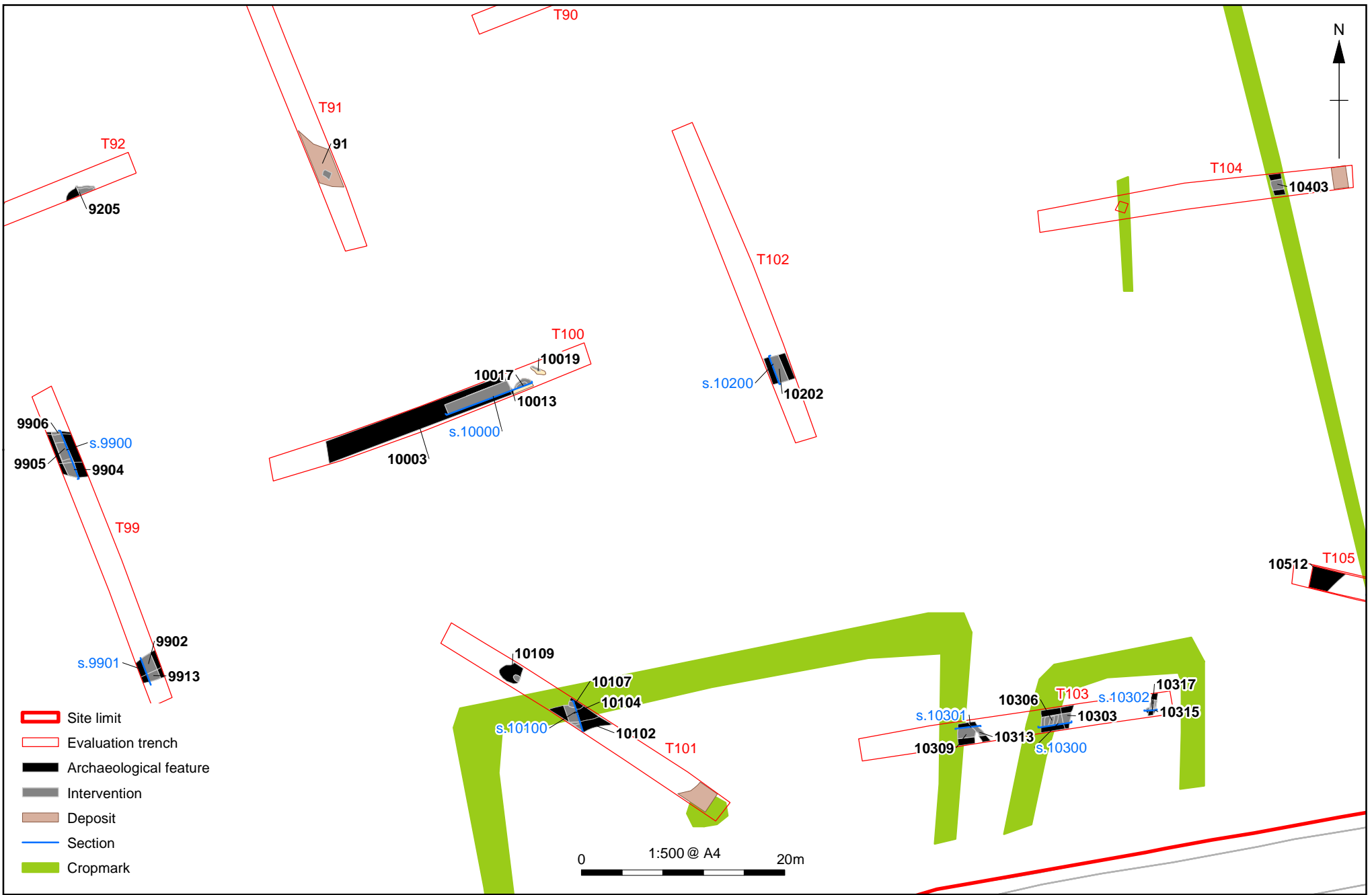

Figure 20: Plan of Trenches 87-89



OS Basemap provided by client

Figure 21: Plan of Trenches 91 and 99-104

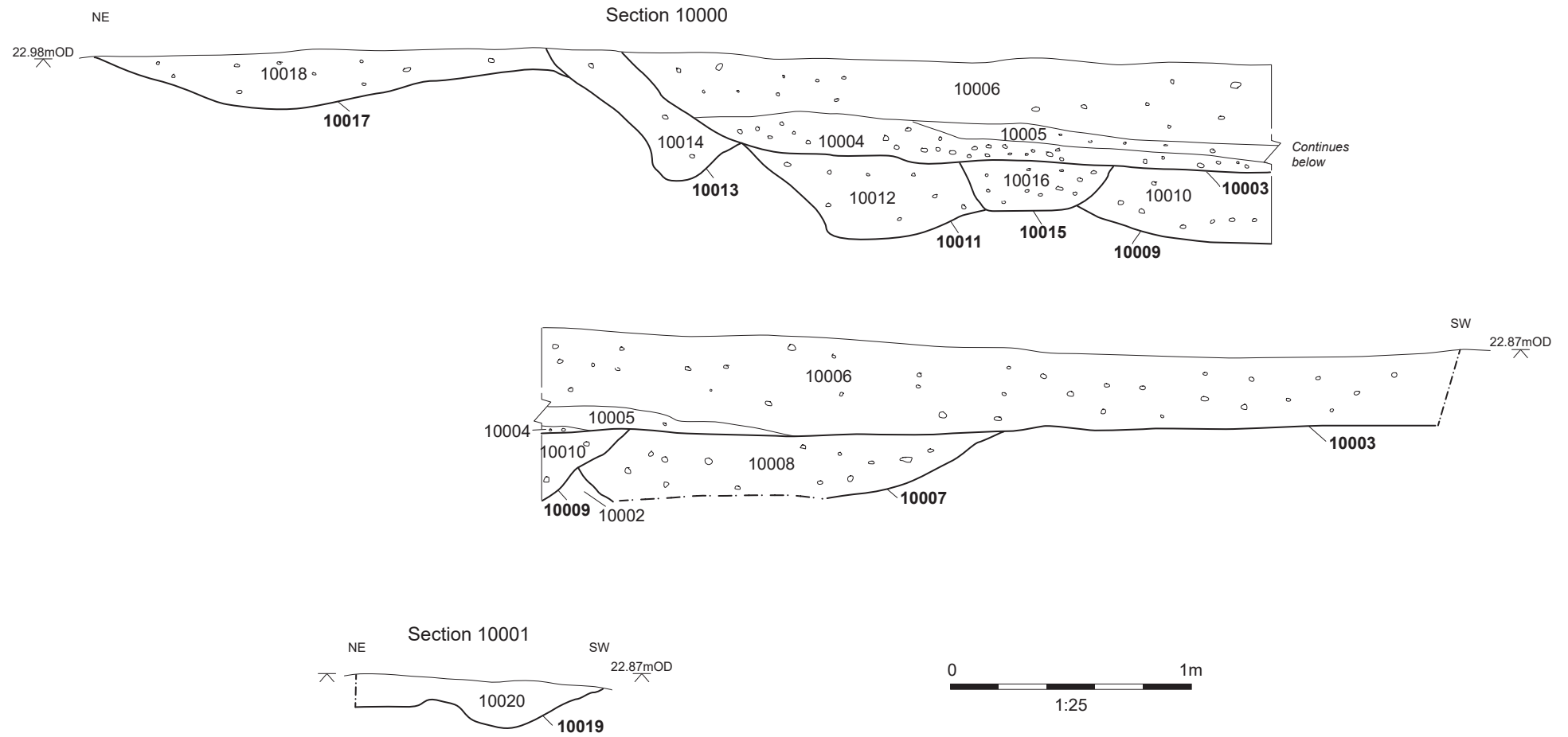

Figure 22: Sections (Trench 100)

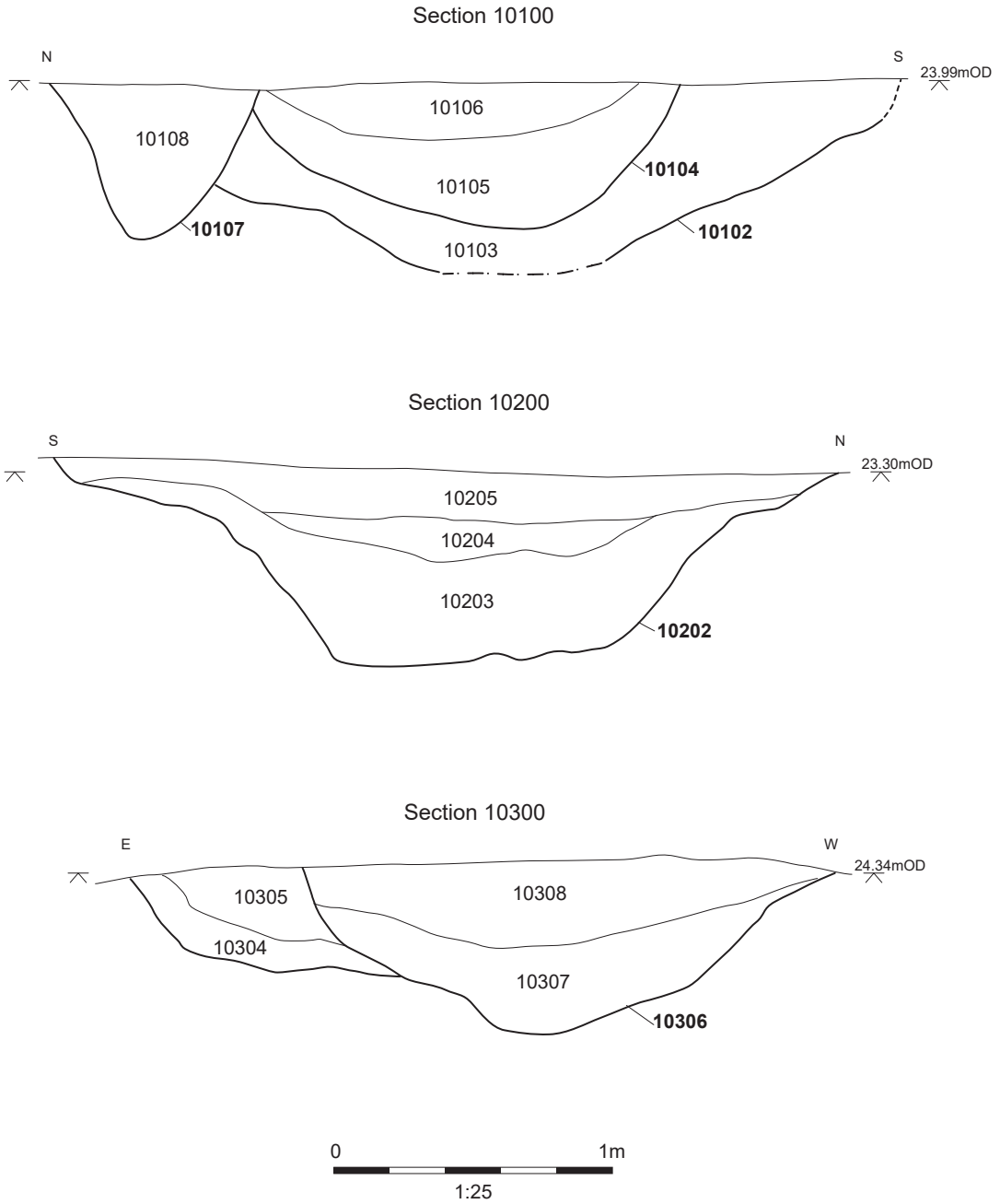

Figure 23: Sections (Trenches 101-103)

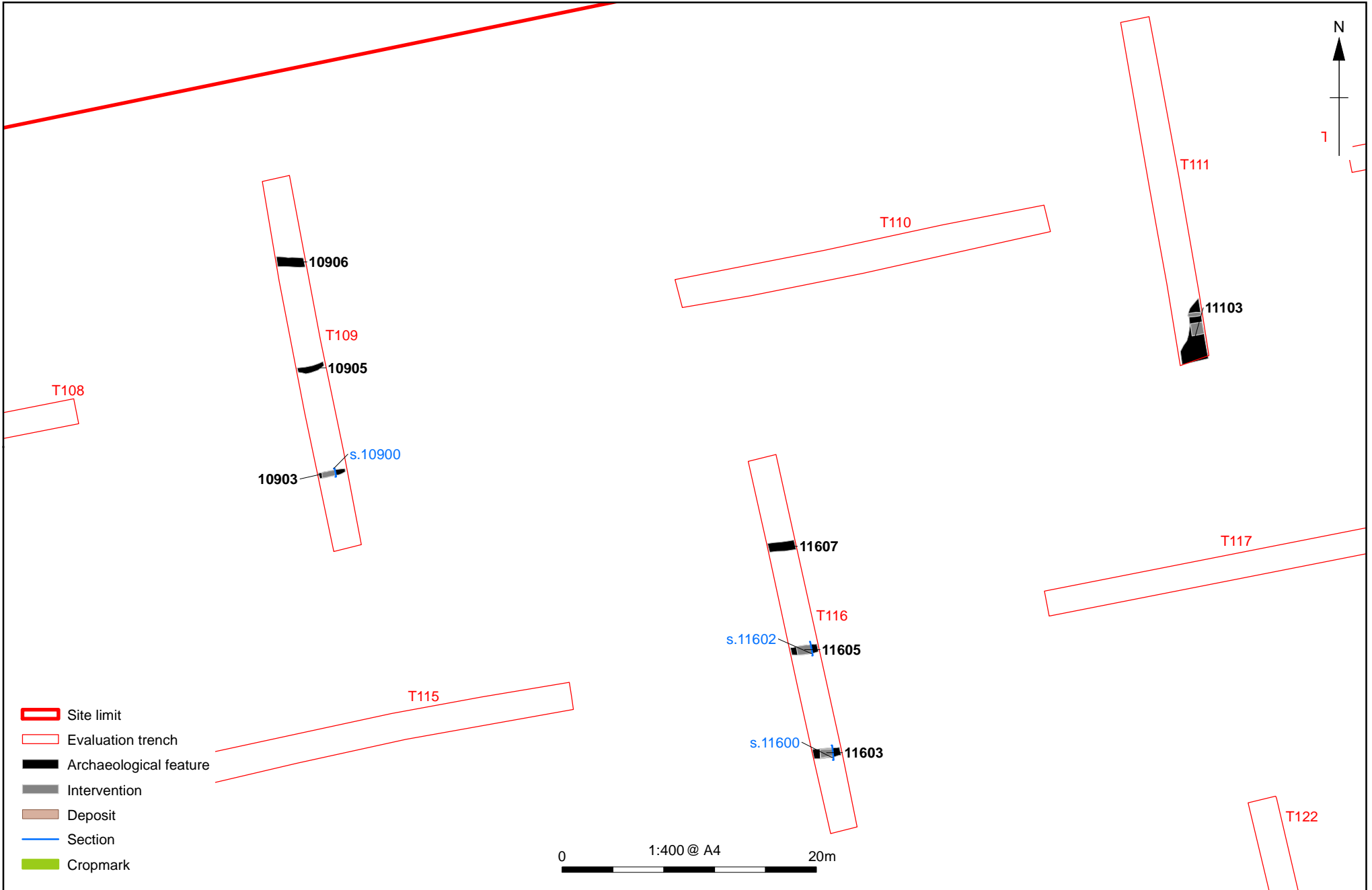

Figure 24: Plan of Trenches 109-111 and 115-117

X:\MLTCEV\_Lower\_Thames\_Crossing\010Geomatics\03 GIS Projects - LTC21W19\Figures\Re-names for Tim\TTC21W19\_Fig25.mxd\aidan.farnan\21/08/2020

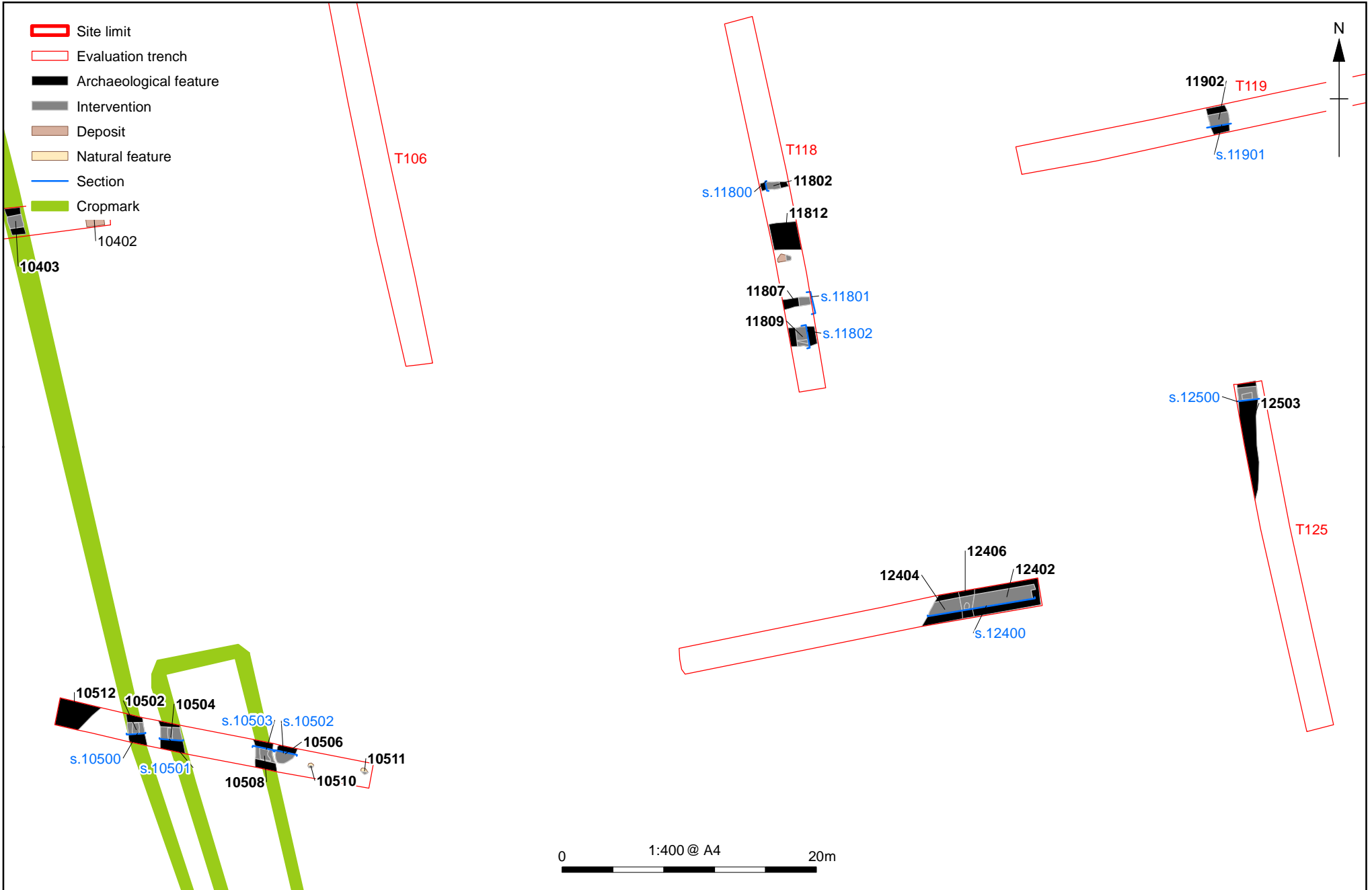

Figure 25: Plan of Trenches 105-106, 118-119 and 124-125

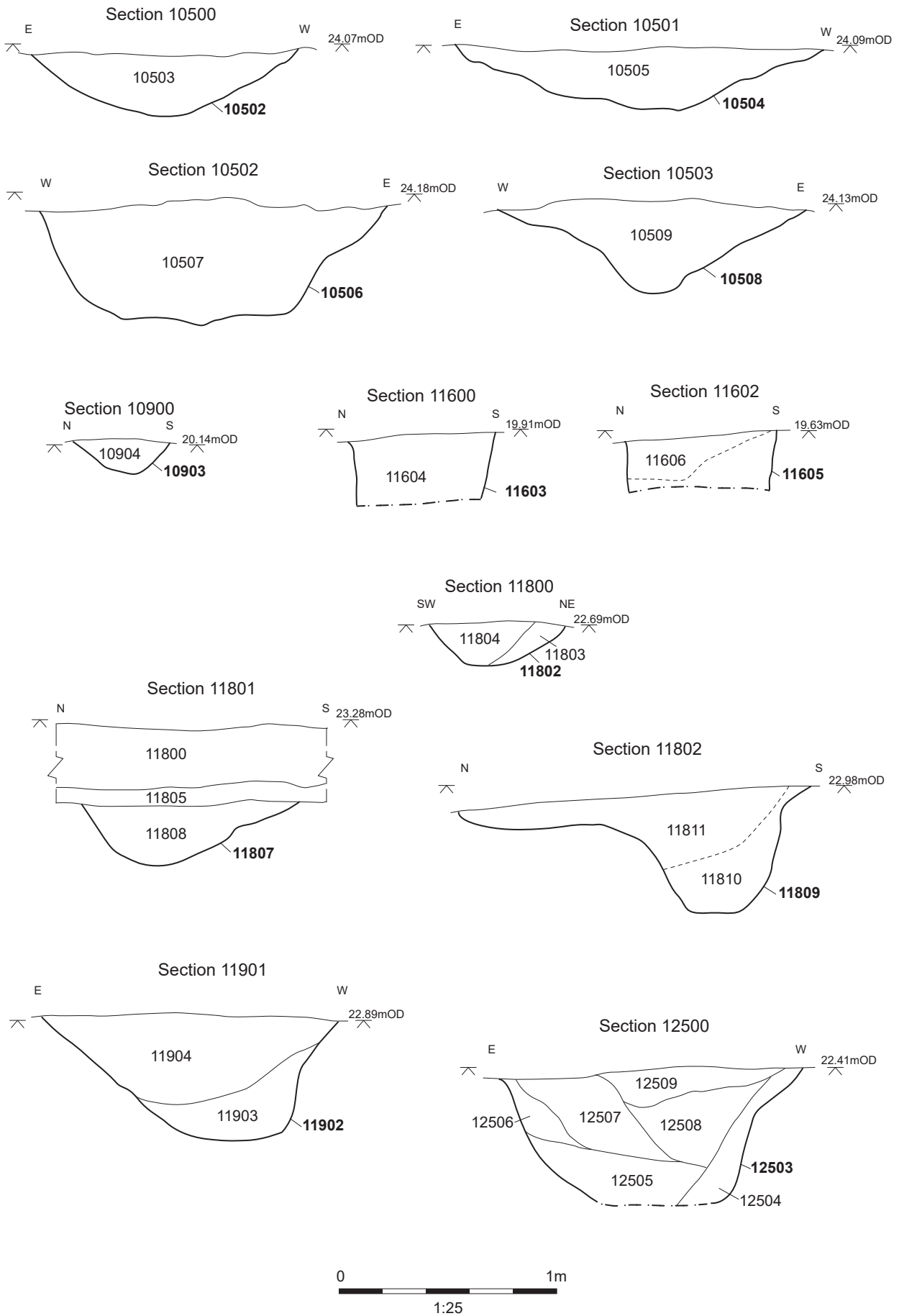

Figure 26: Sections (Trenches 105, 109, 116, 118-119 and 125)

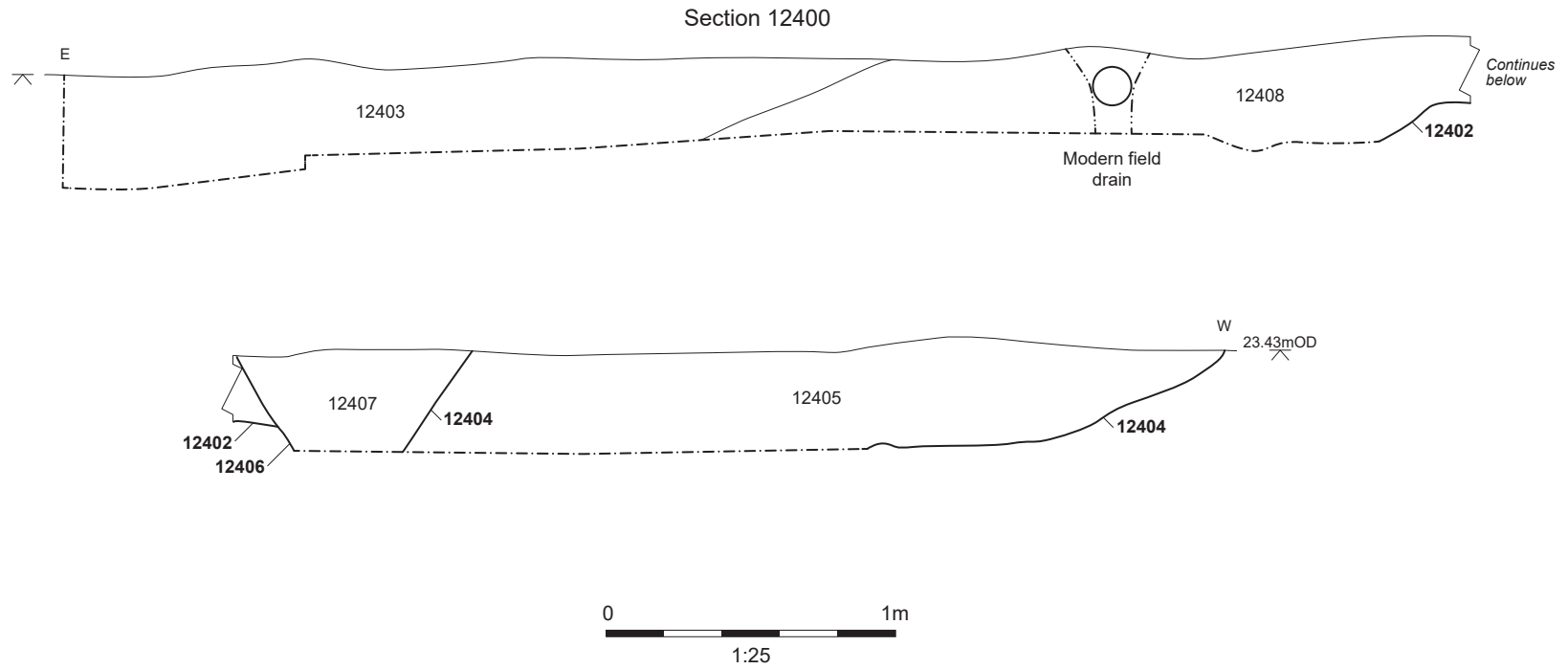

Figure 27: Sections (Trench 124)





Plate 1: Ditch 602 looking north



Plate 2: Ditch 2102 looking east



Plate 3: Ditch 2104 looking east



Plate 4: Ditch 2302 looking west



Plate 5: Ditch 7105 looking east



Plate 6: Ditch 7404 looking east



Plate 7: Section 7600 in Trench 76, looking south



Plate 8: Trench 77 stripped and partly excavated, looking north



Plate 9: Ditches 7703 and 7705, looking south

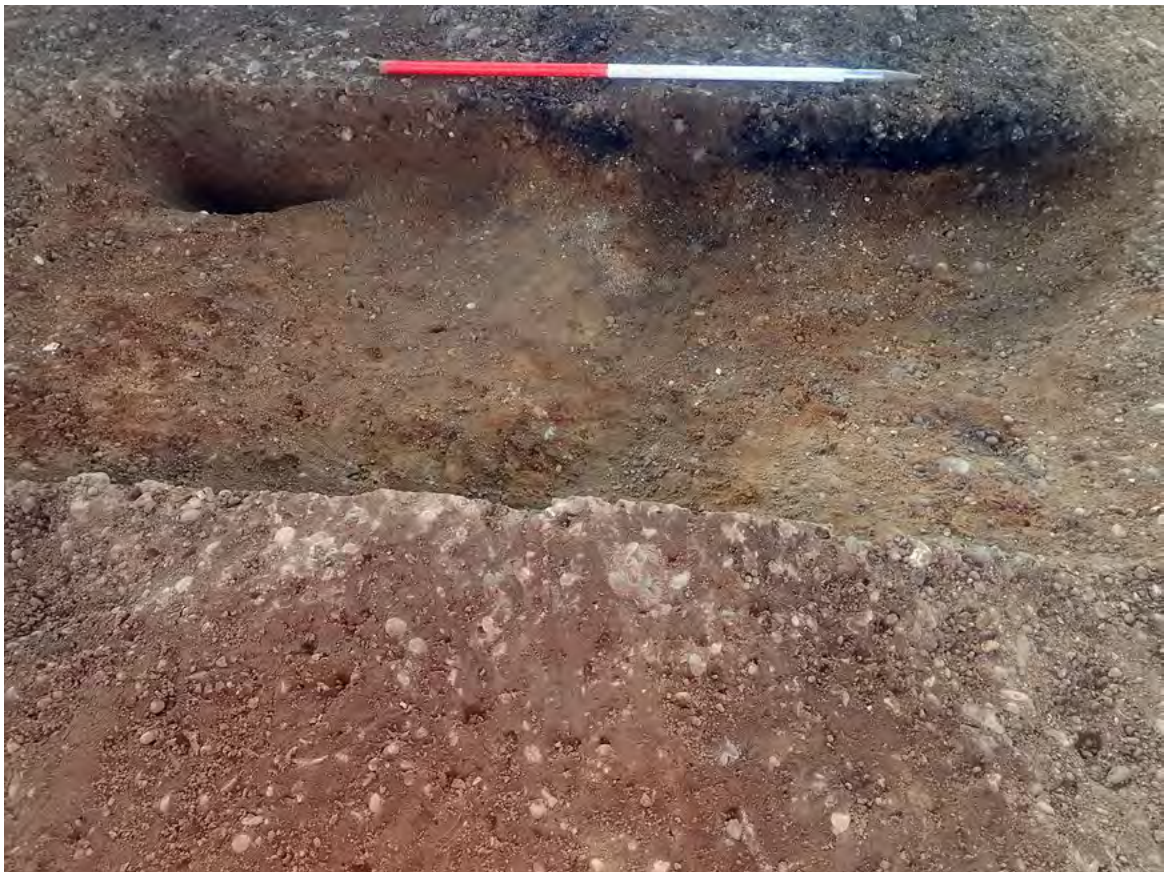

Plate 10: Section 7701 looking south



Plate 11: Ditch 7717 looking east



Plate 12: Ditch 7804 looking WSW



Plate 13: Pits 7807 and 7809, looking south-east



Plate 14: Cremation 9610 with vessel 9611 and fill 9612, looking east



Plate 15: Section through deposit 9703, looking north-east



Plate 16: Ditches 9902 and 9913, looking west





Plate 17: Section through ditches in Trench 100, looking south-west



Plate 18: Ditches 10102 and 10104 with pit 10107, looking north-east



Plate 19: Ditches 10303 and 10306, looking south-east



Plate 20: Ditch 10202 looking west



Plate 21: Ditch 10504 looking south



Plate 22: Ditch 11902 looking south



Plate 23: Ditch 12503 looking south

**COVER SHEET**

|                      |  |
|----------------------|--|
| <b>Title:</b>        | <b>Archaeological Evaluation Report for Trial Trenching of Land Parcel 22<br/>Whitfield South Scheduled Monument<br/>Cropmark Complex, South of Stifford Clays Road, Baker Street, Essex</b> |
| <b>Project Name:</b> | <b>Lower Thames Crossing Enabling Works</b>  |
| <b>Ref No:</b>       | <b>HE540039-BAL-GEN-GEN-REP-HER-00026</b>  |
| <b>Revision No:</b>  | <b>PO1</b>   |
| <b>Review Date:</b>  | <b>2<sup>nd</sup> April 2020</b>   |
| <b>Status:</b>       | <b>S3</b>  |
| <b>No. of Pages</b>  | <b>133</b>   |

| <b>Rev</b> | <b>Date of Issue</b> | <b>Revision Status</b>    | <b>Originator</b> | <b>Checker</b> | <b>Approver</b> |
|------------|----------------------|---------------------------|-------------------|----------------|-----------------|
| PO1        | 02.04.2020           | S3 For Review and Comment | Jack Kilburn      | Peter Chartier | George Pargeter |
|            |                      |                           |                   |                |                 |
|            |                      |                           |                   |                |                 |
|            |                      |                           |                   |                |                 |



# Lower Thames Crossing

Archaeological Evaluation Report for Trial Trenching of  
Land Parcel 22  
Whitfield South Scheduled Monument Cropmark Complex,  
South of Stifford Clays Road, Baker Street, Essex

Document Number: HE540039-BAL-GEN-GEN-REP-HER-00026

**April 2020**



| Revision | Production Date | Prepared by                               | Checked by                               | Approved for release by | Sections revised |
|----------|-----------------|---|--|-------------------------|------------------|
| 1.1      | 27th March 2020 | Anna Moosbauer<br>Cotswold<br>Archaeology | Edward Biddulph<br>Oxford<br>Archaeology | DRAFT                   |                  |
|          |                 |   |  |                         |                  |
|          |                 |   |  |                         |                  |

This Evaluation Report has been prepared for Highways England in accordance with the terms and conditions of appointment stated in the Lower Thames Crossing (LTC) Technical Partner Contract. LTC cannot accept any responsibility for any use of or reliance on the contents of this document by any third party.

# Contents

---

| Section   | Page      |
|---|-----------|
| <b>Summary</b> .....                                      | <b>7</b>  |
| <b>Acknowledgements</b> .....                             | <b>8</b>  |
| <b>1 Introduction</b> .....                               | <b>9</b>  |
| 1.1 Project details and scope of work .....               | 9         |
| 1.2 Location, topography and geology .....                | 10        |
| 1.3 Previous investigations .....                         | 10        |
| 1.4 Archaeological and historical background.....         | 11        |
| <b>2 Project Aims</b> .....                               | <b>15</b> |
| 2.1 General aims .....                                    | 15        |
| 2.2 Specific objectives .....                             | 16        |
| <b>3 Methodology</b> .....                                | <b>18</b> |
| 3.1 Constraints.....                                      | 18        |
| 3.2 Methodology for the evaluation .....                  | 18        |
| <b>4 Results</b> .....                                    | <b>20</b> |
| 4.1 Introduction and presentation of results .....        | 20        |
| 4.2 General soils and ground conditions.....              | 20        |
| 4.3 General distribution of archaeological deposits ..... | 20        |
| 4.4 Trench 1.....   | 21        |
| 4.5 Trench 6.....   | 21        |
| 4.6 Trench 10.....  | 21        |
| 4.7 Trench 16.....  | 21        |
| 4.8 Trench 17.....  | 22        |
| 4.9 Trench 19.....  | 23        |
| 4.10 Trench 23.....                                       | 23        |
| 4.11 Trench 25.....                                       | 23        |
| 4.12 Trench 30.....                                       | 23        |
| 4.13 Trench 32.....                                       | 24        |
| 4.14 Trench 36.....                                       | 24        |
| 4.15 Trench 37.....                                       | 25        |
| 4.16 Trench 38.....                                       | 25        |
| 4.17 Trench 39.....                                       | 26        |
| 4.18 Trench 40.....                                       | 26        |
| 4.19 Trench 42.....                                       | 27        |
| 4.20 Trench 43.....                                       | 27        |
| 4.21 Trench 44.....                                       | 28        |
| 4.22 Trench 45.....                                       | 28        |
| 4.23 Trench 46.....                                       | 29        |
| 4.24 Trench 47.....                                       | 30        |
| 4.25 Trench 48.....                                       | 30        |
| 4.26 Trench 49.....                                       | 30        |
| 4.27 Trench 50.....                                       | 30        |
| 4.28 Trench 52.....                                       | 30        |
| 4.29 Trench 53.....                                       | 31        |



|                   |  |            |
|-------------------|--|------------|
| 4.30              | Trench 56.....                           | 31         |
| 4.31              | Trench 60.....                           | 31         |
| 4.32              | Trench 61.....                           | 32         |
| 4.33              | Trench 62.....                           | 32         |
| 4.34              | Trench 63.....                           | 32         |
| 4.35              | Trench 64.....                           | 32         |
| 4.36              | Trench 66.....                           | 32         |
| 4.37              | Trench 69.....                           | 33         |
| 4.38              | Trench 70.....                           | 33         |
| 4.39              | Trench 73.....                           | 33         |
| 4.40              | Trench 75.....                           | 33         |
| 4.41              | Trench 76.....                           | 34         |
| 4.42              | Finds summary .....                      | 34         |
| 4.43              | Environmental summary .....              | 36         |
| <b>5</b>          | <b>Discussion .....</b>                  | <b>37</b>  |
| 5.1               | Reliability of field investigation ..... | 37         |
| 5.2               | Interpretation.....                      | 37         |
| 5.3               | Evaluation objectives and results.....   | 38         |
| <b>Appendix A</b> | <b>Trench Tables .....</b>               | <b>40</b>  |
| <b>Appendix B</b> | <b>Finds Reports .....</b>               | <b>78</b>  |
| <b>Appendix C</b> | <b>Environmental Reports .....</b>       | <b>96</b>  |
| <b>Appendix D</b> | <b>References .....</b>                  | <b>107</b> |
| <b>Appendix E</b> | <b>Abbreviations and Glossary .....</b>  | <b>110</b> |
| <b>Appendix F</b> | <b>Site Summary.....</b>                 | <b>111</b> |

## Figures

Figure 1 - Map showing the location of Land Parcel 22

Figure 2 - Plan of trench layouts, cropmark features and archaeological features

Figure 3 - Plan of Trenches 1, 6 and 10

Figure 4 - Plan of Trenches 16, 17 and 19

Figure 5 - Plan of Trenches 23, 25, 30 and 32

Figure 6 - Plan of Trenches 36, 37, 38, 39 and 40

Figure 7 - Plan of Trenches 42, 43, 44, 45 and 46

Figure 8 - Plan of Trenches 47, 48 and 49

Figure 9 - Plan of Trenches 50, 52, 53 and 56

Figure 10 - Plan of Trenches 60, 62 and 63

Figure 11 - Plan of Trenches 64 and 66

Figure 12 - Plan of Trenches 69 and 70

Figure 13 - Plan of Trenches 75 and 76

Figure 14 - Sections (Trenches 6, 10, 17 and 39)

Figure 15 - Sections (Trenches 40, 42 and 45)

Figure 16 - Sections (Trenches 47, 62, 63 and 66)

Figure 17 - Sections (Trenches 69 and 76)

## Plates

Plate 1 - Ring-ditch 602, facing south

Plate 2 - Pit 1002, facing east

Plate 3 - Ditch 1703, looking south-west

Plate 4 - Overview of ditches 4406, 4404, and 4403, facing south

Plate 5 - Cremation pit 6603

Plate 6 - Overview of ditches 7510, 7512, and 7514, facing north-east

## Tables

Table 1 - Summary of the prehistoric pottery

Table 2 - Summary and quantification of the pottery by context (Key: EVE estimated vessel equivalent; MV minimum number of vessels; M/LIA mid/late Iron Age)

Table 3 - Summary of fired clay by context

Table 4 - Finds register – metal finds.

Table 5 - Finds register – slags.

Table 6 - The flint assemblage

Table 7 – The samples

Table 8 - The charred remains

Table 9 – Burnt bone - Osteological summary

Table 10 - Summary of fragmentation

Table 11 - Summary of identified elements and bone weights per spit

## Summary

---

Oxford Cotswold Archaeology was commissioned by Balfour Beatty to undertake a trial trench evaluation of Land Parcel 22/23 of the Lower Thames Crossing Pre-Enabling Works. Land Parcel 22/23, named Whitfield South for this investigation, is situated c 70m west of the hamlet of Baker Street and 0.9km west of the village of Orsett within the county of Essex and Thurrock unitary authority (NGR TQ 62910 81217). Only the trenches within land parcel 22 were accessible during this phase of attendance resulting in the excavation of 76 trenches out of a total of 104 that were arranged in the written scheme of investigation. The fieldwork was completed between the 15th January and 3rd February 2020.

The fieldwork revealed some evidence for late Bronze Age to early Iron Age activity within the site, including the remains of a mostly complete large jar from a pit in Trench 36.

The main phase of activity dates to the late Iron Age and Roman periods with archaeological remains encountered in the northern part of the site, along Stifford Clays Road, corresponding to the cropmark evidence. The remains largely comprised field systems including enclosures, ditched boundaries and/or possible trackways. The associated artefactual assemblages indicate a varied range of activities being undertaken at, or at least very close to, the site with evidence of pottery production (kiln-related remains) iron working (smithing hearth bottoms), trade in salt and crop processing. These remains are likely to be part of a larger settlement represented by cropmarks to the north of Stifford Clays Road and evaluated as part of this project (land parcel 21).

Evidence for more recent field enclosure was present in Trenches 17, 23 and 30 with the poorly preserved line of a ditch corresponding to a boundary marked on the 1st Edition Ordnance Survey map.

A number of undated features were also investigated, it is probable that some of these relate to the Iron Age/Romano-British activity within the area. However, it is also possible that some may belong to an earlier phase of activity within the site.

## Acknowledgements

---

Oxford Cotswold Archaeology would like to thank the client, Balfour Beatty, for commissioning this project and managing the site safety and attendances. Thanks are also extended to the Historic Environment Consultants, Richard Havis and Katie Lee-Smith, of Place Services at Essex County Council, for monitoring and providing advice throughout the project.

The project was managed for Oxford Cotswold Archaeology by Steve Lawrence. The fieldwork was directed by Mark Dodd and Robert McIntosh, who were supported by Ben Slader, BJ Ware, Jana Smirnova, Mat Ferron, Jessica Domiczew, Lara Tonizio Feligioni, Megan Lillington, Barbara Grahame, Jack Easen, Rory Coduri, James Fish, Zsuzsanna Veres, James Sinclair, Adam Moffat, Alice Crush, Tara Schug, Ioannis Thanos, Enrico Ravanetti, Pawel Jablonski, Dan Firth, Victoria Green, and Lindsey Kemp. Site survey was undertaken by Caroline Souday and Rachel Alexander and digitising was carried out by Gary Jones, Benjamin Brown and Simon Batsman. Thanks are also extended to the teams of OA staff who cleaned and packaged the finds under the management of Leigh Allen and Geraldine Crann, processed the environmental remains under the management of Rebecca Nicholson, and prepared the archive under the management of Nicola Scott.

# 1 Introduction

---

## 1.1 Project details and scope of work

- 1.1.1 The Lower Thames Crossing Project is located between the A2 in Kent and the M25 in the London Borough of Havering. A new road will run underneath the River Thames through a tunnel and emerge on the northern side of the river at East Tilbury. From the North Portal the road will run to the M25 at Junction 29 via the A13 and pass between North and South Ockendon. The development of the project is managed by LTC, a partnership between Highways England and a consultancy joint venture set up to oversee the scheme.
- 1.1.2 A programme of archaeological trial trenching began in the Essex part of the scheme in November 2019. A scheme-wide specification for trial trenching was written by LTC (Highways England 2018), and in July 2019 LTC commissioned Balfour Beatty to deliver the pre-Enabling Works. Balfour Beatty appointed Oxford Archaeology (hereafter OA) to prepare a project-wide written scheme of investigation (WSI) for the scheme, which (at the request of the key archaeological stakeholders) is divided into two parts, one for the Kent section, the other for Essex and Havering (Oxford Archaeology 2019a, 2019b).
- 1.1.3 Following completion of the project-wide WSIs, OA was also instructed to prepare a series of site-specific or group-site specific WSIs for approval by the key archaeological stakeholders in advance of trial trenching to inform the Development Consent Order (DCO). A detailed WSI was created for Land Parcel 22/23 prior to the trial trenching (Oxford Archaeology 2019c) detailing the archaeological background and potential within Land Parcel 22/23 (Oxford Archaeology 2019c). It also indicated the archaeological aims and objectives appropriate to the investigation of this land parcel by trenching and set out the methodology. This WSI was approved by Richard Havis, Principal Historic Environment Consultant for Place Services, Essex County Council, prior to the start of the fieldwork. Oxford Cotswold Archaeology was commissioned as Balfour Beatty's archaeological contractor to undertake the evaluation in accordance with the approved WSI and local and national planning policies.
- 1.1.4 The fieldwork was completed between the 13th January and 3rd February 2020. All work followed the MoRPHE Project Manager's guide (Historic England 2015), and the Code of Conduct of the Chartered Institute for Archaeologists (CIfA). The archaeological works also adhered to the standards and guidance for archaeological evaluation, excavation and archiving (CIfA 2014a; CIfA 2014b).
- 1.1.5 The fieldwork was monitored by Richard Havis and Katie Lee-Smith, Place Services, ECC, as advisors to the Borough of Thurrock.

## 1.2 Location, topography and geology

- 1.2.1 The Orsett cropmark complex is situated c 70m west of the hamlet of Baker Street and 0.9km west of the village of Orsett (Fig. 1). The scheduled monument is located within the county of Essex and Thurrock unitary authority (centred on national grid reference TQ 62910 81217). The scheduled monument area is roughly T-shaped within the area of the scheme, includes land parcels 22 and 23, and covers an area of 17.16ha. (The area of the scheduled monument within the scheme limits will hereafter be referred to as the 'site'.) The site is bounded to the north by the Stifford Clays Road and to the east by the Grade II listed Baker Street Mill and associated land. The scheduled monument area itself extends further west than the scheme but the site as described by the WSI extends westwards as far as a NNW-SSE aligned trackway. To the south the site extends as far as the A1089, but the scheduled monument extends further south, beyond the A13. The area between the A1089 and the A13 was already evaluated by the Grays by-pass excavation of 1979-80 (Wilkinson 1980, Site 2) and will not be subjected to trial trenching. The area to the south of the A13 will not be evaluated as this area has been heavily quarried.
- 1.2.2 The bedrock geology of the site is variable, comprising clay, sand and silt of the London Clay Formation along the northern edge with a band of sand and gravel of the Harwich Formation across the central area, and Lambeth Group clay, sand and silt towards the southern and eastern parts of the site. The whole site is covered by superficial geological layers of sand and gravel belonging to the Boyn Hill Gravel Member, formed in the Quaternary Period up to 2 million years ago (BGS 2020).
- 1.2.3 The site is largely occupied by a single arable field with smaller paddocks along the eastern and western edges of the site. Within the 1km site buffer the land use is a mixture of agricultural land and urban development associated with the town of Grays to the south-west, and the hamlet of Baker Street to the east. The area has also been bisected by the A13, A1013 and the A1089, which have displaced the historical field boundaries.
- 1.2.4 This land parcel is situated on an upland area to the west of Orsett. The land parcel itself is located at the edge of a plateau with the highest elevations within the southern part at 27m aOD. This slopes down to 25m aOD at the northern edge of the site. A small stream is located within the western extend of the site just to the south of the Springfield Cattery (located north of Stifford Clays Road), which is perhaps suggestive of a spring line in this area. To the north of the site the land drops gradually into the lowland area of the Mar Dyke valley and the river itself is located 1.3km north-west of the site.

## 1.3 Previous investigations

- 1.3.1 No known below-ground archaeological investigation has been undertaken within this land parcel.

## 1.4 Archaeological and historical background

- 1.4.1 The site is situated on the terrace to the south of the Mar Dyke valley where prehistoric features, findspots and cropmarks have been identified, and forms part of the Orsett cropmark complex scheduled monument (Historic England list entry number **1002134**, legacy record **TK174**). The extensive and dense cropmark complex recorded within and around the land parcel was mapped by the Aerial Investigation and Mapping report (Place Services 2019), reproduced in Figure 2. The southern part of the scheduled monument was excavated in 1979-80 by the Grays By-pass rescue excavation of 1979-80 (Wilkinson 1980, Site 2- Baker Street).
- 1.4.2 The scheduled monument complex is on the Heritage at Risk Register 2019. The condition is noted as 'generally unsatisfactory with major localised problems' and the principal vulnerability is from arable ploughing. The trend of the monument condition is declining, presumably from the attrition to buried archaeology from deep ploughing in arable fields (Historic England 2019). Parts of the scheduled area are also very likely to have been disturbed during the A13 widening in the early 1980s.
- 1.4.3 The chronological summary of known archaeology given below is taken from the detailed WSI for Land Parcels 22 and 23 (Oxford Archaeology 2019c).
- 1.4.4 **Neolithic period.** A scheduled early Neolithic causewayed enclosure (Place Services 2019, site 17A) is located 2km south-east of the land parcel, with Neolithic flints recorded nearby. Neolithic flints have also been recorded across several fields 1.5km south-east of the site. A cropmark, a narrow rectangular enclosure aligned east-west with rounded ends, has been recorded 1km south-east of the site, and from its morphology this is suspected to be a mortuary enclosure of Neolithic date.
- 1.4.5 **Early Bronze Age.** No early Bronze Age features have been excavated within the site, but a circular ring ditch 32m in diameter is located 500m north-east of the site and this is probably the remains of an early Bronze Age barrow that was situated on the slope of the edge of the terrace (Place Services 2019, site 82). In addition, the cropmark of a possible ring-ditch, which may well represent a ploughed-out round barrow, was also identified 0.6km south-east of the site (Place Services, site 21).
- 1.4.6 **Later Bronze Age and Iron Age.** The Orsett (Grey Goose Farm) scheduled cropmark complex (**1002134**) includes two small adjacent circular or penannular ring-ditches to the north, and two other small circular ring-ditches further south-west, any or all of which may represent later Bronze Age barrows (Place Services 2019, sites 13, 14 and 15). Small ring-ditches are characteristic of the middle or late Bronze Age in this area, one being found on the A13 at Orsett Cock (Carter 1998) and seven at Mucking (Evans *et al.* 2016). Two further adjacent circular ring-ditches lie within the cropmark complex on the edge of the terrace, north of the main cropmark concentration and just outside the site. Both have gaps in the circuit and are more likely to represent roundhouse enclosures (Place Services 2019, site 13). Another small ring-ditch, also on the north



edge of the terrace, is visible as a cropmark at Baker Street (Place Services 2019, site 49).

- 1.4.7 During the Baker Street excavation in 1979, several features dated to the late Bronze Age to early Iron Age were recorded within the southern part of the scheduled monument and site. These included three small pits containing flint-tempered pottery and charcoal, eight postholes, one large pit and a 10m long NNW-SSE aligned gully. These features were situated in the area of the A1089 loop junction just north of the A13, except for one pit located 200m to the west (Wilkinson 1988, 13-16). Several sub-circular enclosures, linear features and a possible east-west trackway were recorded within the northern part of the site by the aerial survey (Place Services 2019, site 13). These features are located c 300m north of the Baker Street excavation and may also be dated to the late Bronze Age or early Iron Age.
- 1.4.8 Another prehistoric scheduled monument, comprising a middle to late Bronze Age Springfield-style enclosure (or ring-fort) and an overlying settlement believed to date to the Iron Age, is located to the east of the Orsett cropmark complex, c 500m to the east of the site boundary. Further possible prehistoric features, including a probable Bronze Age barrow, have been identified 200m to the south-west of this (Place Services 2019, site 49).
- 1.4.9 The Neolithic causewayed enclosure located 2km east of the site was overlain by an unenclosed early Iron Age site and a middle Iron Age sub-rectangular enclosure (Hedges and Buckley 1978, 219-308). Cropmarks including pits, linear ditches and ring ditches extend from the scheduled area to the south-east and north-west (Place Services 2019, sites 17A, 17B and 72).
- 1.4.10 A large quantity of high-status Iron Age material was recovered by metal detectorists from a field 1.5km south-east of the land parcel and within an extensive rectilinear enclosure. Two Iron Age vessels were also found 0.9km east of the site.
- 1.4.11 **Roman period.** The site may include evidence for Roman activity, reflecting its topographical location on the gravel ridge favoured by similar period settlements. A late Iron Age to late Roman farmstead was originally identified as a cropmark site to the west at Stifford Clays-Primrose Island, c 0.5km west of the site. This was excavated in the 1960s and 1970s and revealed a farmstead that was in use from the late Iron Age to the late Roman period, with enclosures, ditches, pits, cremations and a corn-drying oven. Another possible Roman enclosure site was identified by aerial photography 0.2km east of the site. The survey recorded a double-ditched enclosure on the edge of the terrace. These sites are strung along the north edge of the gravel terrace and may well have been linked by tracks or a road to Roman settlements around Orsett Cock further east, close to a Roman road.
- 1.4.12 An extensive cropmark complex that includes one very large rectilinear enclosure and several smaller ones linked by trackways or field boundaries was identified by the aerial survey 1.5km south-east of the

site. It is likely that some elements of this extensive and regular cropmark complex are of Roman date.

- 1.4.13 Individual findspots of Roman glass were identified 0.6km west of the site, although these records may be duplicate entries as one is from the Essex HER and one from Pastscape.
- 1.4.14 **The medieval period.** Middle Saxon activity has been identified to the east and south-east of the land parcel. The Orsett causewayed enclosure, located 2km east of the site, was reused as a Saxon funerary monument in the 7th-8th century. A Saxon settlement was also located 2km east of the site at Orsett Cock.
- 1.4.15 It was thought that a dense pattern of pits of varying size and shape dispersed across the site (Place Services 2019, sites 13-14) may relate to Saxon activity. Some of the more elongated features were thought likely to represent Saxon Grubenhauser (sunken-featured buildings) (Place Services 2019). However, excavations directly to the south of the monument indicated that some of these features identified as pits by cropmark interpretation were of geological origin. This trend continued within Land Parcel 22/23.
- 1.4.16 In the late Saxon and later medieval period the land parcel was located within the parish of Orsett. The nucleated medieval settlement of Orsett was located 1.5km ENE of the site. It is likely that in the later medieval period the land parcel was used as agricultural land associated with this settlement. It is also possible that a medieval roadside settlement or one or more dispersed farmsteads extended along Stifford Clays Road within the northern part of the site.
- 1.4.17 In 1994 a watching brief was undertaken at Grey Goose Farm, c 100m south of the scheduled area and c 300m west of the site. A domestic rubbish pit was found to contain oyster shell, burnt organic material and medieval pottery dating to the 12-13th century. This suggests that there was medieval activity close to the site, possibly in the form of a farmstead situated south of Stifford Clays Road.
- 1.4.18 A number of possible medieval droeways have been observed as cropmarks within the wider area and several of these have been identified within or close to the site. These droeways may have been used to take livestock to and from the marshland or lowland to the upland ridge. Several trackways were identified south of the Stifford Clays Road during the 1979 Baker Street excavation along the A13.
- 1.4.19 The tithe and OS maps indicate the presence of a possible long-standing boundary within the western extent of the site. This boundary ran parallel with another, defining a thin land parcel that extended almost as far as the Mar Dyke to the north and down to the Stifford-Stanford Road to the south. It is possible these boundaries define a former droeway.
- 1.4.20 **Post-medieval period.** Documentary evidence indicates that during the later post-medieval period the site was situated just to the south of a roughly east-west aligned road from Stifford to Orsett. Grey Goose Farm is shown on the Orsett Tithe map of c 1840 to the south-west of the site. The tithe map also indicates that there were several NNW-SSE aligned

field boundaries across the site and some of the cropmarks that were identified within the site can therefore be attributed to this date. The site appears to have been used as agricultural fields in the 19th century and the owners of the southern part of the site were the Southgate Chapel Estate. The northern part of the site belonged to William Wingfield of Orsett Hall (Kemble, 2009).

- 1.4.21 A number of the pits located within the area of the site may be of post-medieval date. Several of these pits were sampled in the late 1970s and early 1980s and one located just south-west of the site was interpreted as a post-medieval pit. Another sample excavation along the western boundary of the site found no evidence of archeological features but did find post-medieval surface finds including pottery, glass, clay pipe stems, bone and tile.
- 1.4.22 The hamlet of Baker Street is located c 150m east of the site at a crossroads between the east-west road from Stifford to Orsett and a north-south road leading to Chadwell. Several listed buildings are located within the hamlet of Baker Street and the nearest to the scheduled monument is the Grade II listed Baker Street Windmill located 100m to the east of the site. This windmill dates from 1674 but is now ruinous. Two homesteads are shown on the c 1840 tithe map and subsequent OS maps just south of the Stifford Road in an area which is not part of the scheduled monument or the site. These buildings are now known as Kempsters Farm and Whitfield Cottage.
- 1.4.23 **Undated features and cropmarks.** The land parcel contains a large number of undated pit-like features of an unknown date and function. The undated pits that have been identified within the site itself have been showing to be geological in origin. A number of 'pit' features were excavated prior to the widening of the A13 during excavations at Grey Goose Farm in the late 1970s. This excavation took place in the area of the A13 within the southern part of the site. These features appeared as discrete sub circular pits on the aerial photographs. When some of these features were excavated, they were determined to be natural periglacial features and several were interconnected (Wilkinson 1988, 15).
- 1.4.24 The site also contains a number of linear features and rectilinear and sub-circular enclosures. Based on the previous investigations within the surrounding area it is likely that the cropmarks represent multi-period activity dating from the prehistoric, medieval and post-medieval period. The only cropmarks that can be tentatively dated are the NNW-SSE linear field boundaries and trackways which may be medieval or post-medieval in date.

## 2 Project Aims

---

### 2.1 General aims

2.1.1 The general project aims of the project were as follows:

- To establish the presence or absence of archaeological remains along the line of the scheme, and the extent of any areas where remains appear likely to be absent;
- In areas where archaeological remains are known or suspected, to clarify the reliability of the cropmark or geophysical survey evidence;
- In areas where no archaeological remains are indicated by aerial or geophysical survey, to clarify whether this apparent absence of remains is genuine;
- To determine the degree of complexity of any surviving horizontal or vertical stratigraphy and particularly to investigate areas where topography indicates the likelihood of deep deposit sequences for evidence of buried archaeological horizons and palaeoenvironmental sequences;
- Where remains are present, to determine the period(s) represented, the extent, state of preservation and character of the archaeological remains;
- To establish the range and state of preservation of archaeological artefacts, and through their recovery and examination, to establish the potential for information about the economy, status and contacts of past inhabitants of the scheme footprint;
- To determine whether palaeoenvironmental remains are preserved, and, where these are found, to determine their types (e.g. charred plant remains, waterlogged remains, molluscan remains), state of preservation and potential for environmental information. This will be achieved through the recovery of samples from sedimentary sequences and archaeological features suitable for assessment of a range of palaeoenvironmental remains (e.g. charred and waterlogged plant remains, charcoal, insects, pollen, diatoms, ostracods/foraminifera and molluscs) and scientific dating (e.g. radiocarbon and OSL dating);
- To investigate and record the extent, character and chronology of the sedimentary sequences, particularly those immediately adjacent to and in floodplains, contained within palaeochannels or in dry valleys, and to use the data to refine existing geoarchaeological (predictive) deposit models.
- To place any identified archaeological remains into their local and, where appropriate, regional or national context, and to assess the implications of any such discoveries for our current understanding of settlement and landscape change in the area, including an assessment of the associations of any remains with reference to the historic landscape;
- To provide sufficient information to enable the LTC archaeological advisor, in consultation with the Key Archaeological Stakeholders, to determine the significance of the archaeological assets identified within the land parcel;

- To provide a report on the discoveries to inform the Environmental Statement (ES) supporting the Development Consent Order (DCO) and support the preparation of a further archaeological mitigation strategy for the Enabling Works and Construction phases of the scheme;
- Following the DCO, to deposit the report in the public domain, and to generate an accessible and useable archive which will allow future research of the evidence to be undertaken.

## 2.2 Specific objectives

2.2.1 The specific project objectives were as follows:

- To adhere to and fulfil the condition requirements of the scheduled monument consent (HE ref: S00226205);
- To conduct the programme of archaeological investigation within the general research parameters and objectives defined by the revised East of England Research Framework (ed Medlycott 2011);
- To investigate activity carried out in the landscape surrounding causewayed enclosures and burial monuments of the Neolithic and early Bronze Age periods, whether peripheral burial, deposits related to visits, or reuse for burial or other purposes in later periods;
- To clarify whether the circular ring-ditches are the remains of burial monuments or 'shrines' of the Bronze Age, and if so, to establish their date and duration of use within and beyond the period;
- To establish whether settlements and burial monuments of the Bronze Age are contemporary, and in particular, whether occupation at Grey Goose Farm began in the later Bronze Age, and its chronological relationship to the ring ditches that may represent burial monuments adjacent;
- To establish the extent, character and density of Roman activity within the scheduled area, and in particular, whether the undated cropmark enclosures are Roman, and if so, establish their duration of use;
- For the early medieval period, to determine whether Anglo-Saxon sunken-featured buildings and other buildings are present within the Orsett cropmark complex, and to determine the extent, density, character and status of the settlement believed to be present;
- To clarify whether the cropmarks provide an accurate representation of the range, quantity and types of archaeological features present within the parcel;
- To establish the character and date of the extensive pits across the land parcel, and to determine whether these are all of one type or period, or whether they encompass several types and span several periods of activity;
- To establish the date of the possible medieval or post-medieval field boundaries and trackways that have been identified within the land parcel;
- To establish the presence or absence of possible medieval droveways aligned through the land parcel;

- To establish the presence or absence of medieval and post-medieval farmsteads which may have been located within the land parcel.

## 3 Methodology

---

### 3.1 Constraints

- 3.1.1 Several constraints are present within and surrounding the land parcel, including overhead and buried services, unexploded ordnance (UXO), and ecological constraints. Responsibility for establishing safe exclusion zones for work adjacent to the constraints rested with the Principal Contractor (Balfour Beatty). A detailed risk assessment and method statement (RAMS) for the works was produced by OA and reviewed and approved by the Principal Contractor before the commencement of any fieldwork.
- 3.1.2 **Services.** Overhead services comprise two high voltage (132kV or greater) parallel NNW-SSE aligned overhead cables attached to pylons, which bisect the site. A pair of pylon towers are located within the scheduled monument. A further high voltage overhead line set on poles (11 or 33kV) is present on the same alignment within the eastern part of the site close to the boundary between the main arable field and smaller paddocks. An irrigation system also runs down the east side of Land Parcel 22.
- 3.1.3 There are several buried services that are close to the land parcel including an Anglian Water foul water-pipe which bisects the easternmost part of the site. There are also telecoms underground cables which bisect the north-eastern part of the site and run along Stifford Clays Road to the north and the A1089 to the south. A high-pressure gas pipe is located close to the western boundary of the site.
- 3.1.4 These constraints and associated exclusion zones for safe working were considered for the trench layout. Exclusion zones were generally applied for services as follows: gas main (15m), high voltage (HV) overhead power lines (10m), buried HV electrical mains (10m), lower voltage electrical services (5m), water mains (5m). A permit to dig system was put in place by Balfour Beatty to ensure that the constraints were observed.
- 3.1.5 **Unexploded Ordnance (UXO).** The UXO survey identified a moderate potential for unexploded ordnance within the northern part of the site and a low hazard for the southern part. Guidance for the procedures to be followed on site was supplied by a specialist firm qualified in the detection and removal of UXO.
- 3.1.6 **Ecological constraint.** There are no known statutory ecological constraints within the site boundary. The northern border of the site along Stifford Clays Road is defined by a broad band of mature shrubs which was not removed as part of this evaluation.

### 3.2 Methodology for the evaluation

- 3.2.1 The area of the scheduled monument within the scheme boundary that has not previously been removed by construction activities is

approximately 15.11ha in extent. This includes all land otherwise inaccessible due to constraints. However, only the main agricultural field within the land parcel, equating to 14.2ha of land, was available for trenching at the time of the fieldwork. Consequently, only the 76 trenches located within this area were excavated, including several non-standard trenches and areas: one 20m by 30m area, two 15m by 15m areas, one 20m by 10m area, and one 30m by 5m trench. All other trenches were excavated at the standard width of 2m and lengths of either 30m or 50m.

- 3.2.2 All trenches were located using a Global Positioning System (GPS) prior to machine excavation and were excavated using a tracked excavator fitted with a toothless bucket under constant archaeological supervision.
- 3.2.3 Any features revealed in the trenches were hand cleaned and sampled by hand excavation and recorded as outlined within the approved WSI. All finds were bagged by context throughout the evaluation and were recovered for further investigation.



## 4 Results

---

### 4.1 Introduction and presentation of results

- 4.1.1 The results of the evaluation, including a stratigraphic description of the trenches that contained archaeological remains, are presented below. Full details of all trenches, including dimensions and depths of all deposits can be found in Appendix A. Finds data are tabulated in Appendix B.
- 4.1.2 Context numbers reflect the trench numbers unless otherwise stated. For example, pit 102 is a cut within Trench 1, while ditch 10304 is a cut within Trench 103.
- 4.1.3 An overview of the results for the site is shown on Figure 2. Further detailed plans of the trenches which contained archaeological features are contained in Figures 3-13 and selected sections are shown in Figures 14-17.

### 4.2 General soils and ground conditions

- 4.2.1 The soil sequence varied slightly across the site, with clayey sand and silt deposits containing high proportions of gravel. This suggests that only the surface geology of Boyn Hill Sand and Gravel was encountered for the most part, and that some of the geological variation within the site may be influenced by the variable bedrock geology, which includes Lambeth Group sand/silt/clay within the southern and eastern portions of the site, Harwich Formation sand/gravel across the central area, and London Clay Formation clay/silt/sand along the northern portion.
- 4.2.2 Subsoil deposits ranging between 0.05-0.4m thick were encountered across the site. The majority of these are likely to represent the relict remains of a former ploughsoil which now lies below the depth of the current ploughsoil.
- 4.2.3 The topsoil consisted of mid to dark grey brown sandy silt and clayey silt measuring between 0.28-0.4m thick.
- 4.2.4 Ground conditions throughout the fieldwork duration were poor, with soft ground and high proportions of surface water due to persistent rain. Archaeological features, where present, were relatively easy to identify against the underlying geology. Several silty areas identified within the trenches were investigated and proved to be of natural origin.

### 4.3 General distribution of archaeological deposits

- 4.3.1 Archaeological features were encountered in 38 of the trenches, with activity centred predominantly within the eastern half of the site, particularly the north-east corner.
- 4.3.2 The evaluation confirmed the presence of several linear features within the site which had been identified as cropmarks by the aerial investigation and mapping report (Place Services 2019) and other available data relating to the scheduled monument. These features, discussed in more detail below, are likely to be representative of late prehistoric and Roman field boundaries. It is also possible that some of the boundaries may relate

to medieval activity within the area, although no dating evidence has been recovered to prove this.

- 4.3.3 Trenches 2, 3, 11, 13, 27, 54, 55, 71, and 72 contained only natural features derived mostly through variations in the natural geology. These were tested by hand-excavation through slots 1102, 2703, 5503, and 7203.
- 4.3.4 Trench 29 contained one modern ceramic field drain (2902).
- 4.3.5 No features of any kind were observed in Trenches 4, 5, 7, 8, 9, 12, 14, 15, 18, 20, 21, 22, 24, 26, 28, 31, 33, 34, 35, 41, 51, 57, 58, 59, 65, 67, 68, and 74.

## 4.4 Trench 1

- 4.4.1 Two intercutting N-S aligned ditches were encountered in Trench 1 (Fig. 3). The earlier feature (103) measured 0.44m wide and 0.16m deep and had moderately sloping sides and a flat, partially truncated base. The single fill contained no finds.
- 4.4.2 The feature's western side was cut by ditch 105, which measured 1.4m wide and 0.64m deep and had steep sides and a concave base. Although the feature contained two fills, no finds were recovered.

## 4.5 Trench 6

- 4.5.1 Two features were investigated in Trench 6 (Fig. 3); both appeared to correspond to cropmarks. Ditch 602 was located near the western end of the trench, matching a semi-circular cropmark. The feature measured 1.33m wide and 0.37m deep. It had steep sides and a flat base and contained a single, sterile fill.
- 4.5.2 Further east, a small, possible pit (604) was encountered. This measured 1.84m long, 1.02m wide and 0.2m deep and had a mostly irregular profile. The single fill contained some fragments of worked flint.

## 4.6 Trench 10

- 4.6.1 A small pit (1002) was encountered in Trench 10 (Fig. 3). This measured 0.43m in diameter and 0.22m deep. It had moderately steep sides and a concave base and contained a single, sterile fill.

## 4.7 Trench 16

- 4.7.1 Trench 16 revealed a total of four intercutting ditches on two alignments (Fig. 4). Ditch 1609 represented the only NW-SE-aligned feature, which measured 0.41m wide and 0.09m deep and had moderately sloping sides and a concave base. The ditch appeared to terminate near the northwest corner of the trench. Its single fill contained no finds.
- 4.7.2 The feature partially cuts ditch 1607, which extended on an E-W alignment slightly to the south. It measured 1.85m wide and 0.54m deep and had moderately steep sides and a concave base. The ditch contained a single fill which produced fragments of late Iron Age pottery.
- 4.7.3 Ditch 1605 to the south runs on the same alignment as 1607, although the relationship between the two features remains unclear. Ditch 1605

measured 0.7m wide and 0.26m deep and had moderately sloping sides and a flat base. The single fill contained no finds and was cut on the southern side by ditch 1603.

- 4.7.4 Ditch 1603, the southernmost of the three E-W aligned features, measured 0.66m wide and 0.27m deep. It had steep sides and a concave base. The single fill produced no finds.
- 4.7.5 The E-W aligned ditches match a linear cropmark which continues further east; features matching this were also observed in Trenches 17 and 37.

## 4.8 Trench 17

- 4.8.1 Trench 17 revealed a number of discrete features and intercutting linear and curvilinear ditches (Fig. 4). Owing to the density and complexity of the archaeological remains, not all features were excavated.
- 4.8.2 Towards the southern end of the trench, ditch 1703 extended on a NE-SW alignment from the north-west baulk before terminating within the trench. The feature measured 0.66m wide and 0.34m deep and had steep sides and a concave base (Fig. 14 Section 1701). Its single fill (1704) contained fragments of late Bronze Age/early Iron Age pottery. The ditch cut across the top of ditch 1707 and was cut by a modern field drain.
- 4.8.3 Ditch 1707 extended on a similar alignment as 1703 and measured 1.4m wide and more than 0.48m deep. It had steep sides but, due to excavation depth restrictions, the base was not reached. The feature contained at least one fill (1708), which produced fragments of ceramic building material.
- 4.8.4 Just to the north, two sherds of late Iron Age pottery were collected from the terminus of unexcavated ditch 1711.
- 4.8.5 A N-S aligned ditch (1724) was investigated near the centre of the trench. The feature measured 1.26m wide and 0.4m deep and had a steep western side and a moderately sloping eastern side. A single deposit (1725) contained fragments of middle Iron Age pottery and burnt clay.
- 4.8.6 Two intercutting pits (1718 and 1726), which only partially extended into the trench, were investigated near the northern end of the trench. The surviving extent of the earlier feature, 1718, measured 1.4m long, 0.54m wide and 0.44m deep. It had a steep side and concave base, and its single fill (1719) produced a small assemblage of late Iron Age pottery.
- 4.8.7 Pit 1726 measured 1.3m wide and 0.38m deep. It had steep sides and a flat base. Fragments of late Iron Age pottery as well as burnt clay were recovered from the single fill (1727).
- 4.8.8 Ditch 1720 crossed the northern end of the trench on a NW-SE alignment. It measured 0.8m wide and 0.44m deep and had steep sides and a concave base. Fragments of burnt clay were recovered from the single fill (1721).

## 4.9 Trench 19

- 4.9.1 Trench 19 contained two NW-SE aligned ditches, which roughly matched a set of linear cropmarks, although with an error margin of several metres (Fig. 4). Neither feature was seen in any of the surrounding trenches.
- 4.9.2 The northernmost of the features, ditch 1902, matched the alignment and positioning of the southern cropmark, but terminated within the trench. The feature measured 0.88m wide and 0.41m deep and had steep sides and a slightly irregular base. No finds were recovered from the single fill.
- 4.9.3 Approximately 5m to the south, ditch 1904 crossed the trench on a parallel alignment to 1902. The feature measured 0.1m wide and 0.39m deep and had steep sides and a slightly concave base. A single sterile fill was observed.

## 4.10 Trench 23

- 4.10.1 A N-S-aligned ditch (2302) was encountered at the eastern end of Trench 23 (Fig. 5). The feature measured 1.5m wide and at least 0.5m deep but the base was not reached due to excavation depth restrictions. The sides of the ditch appeared steep, though with a slight convex curve, and contained a single fill which did not produce any artefacts.
- 4.10.2 A second, very shallow possible ditch (2304), parallel to 2302, was investigated slightly further west. The feature measured 1.94m wide but only 0.15m deep, with shallow irregular sides and an irregular base. No finds were recovered from the sterile fill.

## 4.11 Trench 25

- 4.11.1 A NW-SE aligned possible ditch (2503) was encountered in Trench 25 (Fig. 4). The feature measured 1.96m wide and 0.52m deep, with a steep northern side and a more moderately sloping southern side, leading onto a flat base. The bottom and top fills (2505 and 2504 respectively) contained no finds, but a thin middle fill (2506) produced a number of burnt clay fragments.

## 4.12 Trench 30

- 4.12.1 Trench 30 (Fig. 4) exposed a single N-S aligned ditch (3003), which measured 1.12m wide and more than 0.5m deep. It had steep, slightly concave sides, but due to excavation depth restrictions the base was not reached. The feature contained at least two fills, both of which were sterile and produced no finds. The ditch matched no cropmarks and was not observed in any other trenches.

## 4.13 Trench 32

- 4.13.1 A roughly E-W aligned ditch (3202) was investigated near the southern end of Trench 32. The feature measured 0.6m wide and 0.2m deep, and had steep sides and a concave base. A single fragment of ceramic building material was recovered from the fill.
- 4.13.2 A possible pit just to the south of the ditch was only partially exposed within the trench. The feature remained unexcavated.

## 4.14 Trench 36

- 4.14.1 A number of ditches and pits were encountered in Trench 36 (Fig. 6); not all features were excavated. None of the features corresponded to any cropmarks, and they did not appear to continue into any adjacent trenches.
- 4.14.2 Three pits were investigated within the trench; the westernmost feature, pit 3613, was only partially exposed. The feature measured 0.85m long, 0.54m wide and 0.54m deep, and had with steep sides and a flat base. This contained a single fill (3609) that yielded a substantial assemblage of pottery (140 sherds, 2143g) representing at least two vessels, with the majority of the sherds from a large high-shouldered jar dating to the later part of the late Bronze Age or earliest Iron Age (c 1000-600 cal BC).
- 4.14.3 Pit 3602, further to the east, measured 1.18m in diameter and 0.34m deep. It had steep, uneven sides and a concave base. The feature contained a single fill with some charcoal and poorly preserved daub inclusions; a bulk sample was recovered to facilitate further analysis.
- 4.14.4 Posthole 3619 near the eastern end of the trench was investigated. It measured 0.28m in diameter and had a depth of 0.36m, with near-vertical sides and a concave base. A single fill produced no finds.
- 4.14.5 Three other discrete features were recorded in plan but not investigated.
- 4.14.6 Near the western end of the trench, a NE-SW aligned ditch (3621) entered the trench from the south-west and terminated within its extent. The feature measured 0.56m wide and 0.24m deep and had a V-shaped profile. The feature was filled by a single deposit (3622) which contained fragments of Iron Age pottery.
- 4.14.7 Two linear features running on NW-SE and NE-SW alignments across the middle of the trench were not investigated as part of the evaluation.
- 4.14.8 Four intercutting ditches, all on a N-S alignment, were encountered at the eastern end of the trench. No relationship could be established between the two easternmost ditches (3614 and 3616) and the other three (3617 and 3618) owing to a small gap between them.
- 4.14.9 Ditch 3614 was cut by ditch 3616; the feature's surviving width was 0.4m, with a depth of 0.2m, and had a steep surviving side and a concave base. The single fill contained no finds.
- 4.14.10 Ditch 3616 measured 1.25m wide and 0.46m deep, and had steep, slightly stepped sides and a narrow, flat base. The feature contained two fills, with the upper fill (3625) producing fragments of worked flint.

- 4.14.11 Ditch 3617 measured 2.2m wide and at least 0.48m deep; due to excavation depth restrictions the base was not reached. The feature was filled by four deposits (3612, 3626, 3627=3628, and 3629), with 3612 containing large proportions of late Iron Age pottery, possibly the result of a deliberate dumping event, while the other fills were sterile.
- 4.14.12 The ditch was in turn cut by 3618. The ditch measured 1.04m wide and 0.42m deep, with steep sides and a flat base, and contained three fills (3610, 3611 and 3630). The lower fill (3611) contained large proportions and charcoal and early Roman pottery fragments, while the top fill (3610) produced flint and more early Roman ceramic fragments. The middle fill (3630) contained no finds.

## 4.15 Trench 37

- 4.15.1 A total of three pits and four ditches was encountered in Trench 37, although not all of them were hand-investigated (Fig. 6). Three linear ditches (3714, 3715 and 3716) crossed the northern corner of the square trench on an E-W alignment, matching a linear cropmark. While these were only recorded in plan, 1st/2nd century amphora sherds were collected from the surface of 3714.
- 4.15.2 Ditch segment 3705, orientated N-S, was located to the south of the three other ditches. The feature measured 10.1m long, 0.46m wide and 0.16m deep. It had a steep sides and a flat base, and contained a single fill, which produced fragments of late Iron Age pottery.
- 4.15.3 Two pits were encountered to the east of ditch segment 3705. Pit 3718, the westernmost of the two, measured 1.35m long, 0.8m wide and 0.22m deep. It had steep sides and a concave base and contained a single fill (3719), which produced fragments of late Bronze Age/early Iron Age pottery.
- 4.15.4 Slightly further east, pit 3707 measured 1.34m long, 0.92m wide and 0.28m deep. It had steep sides and a flat base and contained a single sterile fill.
- 4.15.5 An area of natural disturbance (3720) to the west of ditch 3705 matched the location of a large discrete cropmark and was tested, but found to be of no archaeological significance.

## 4.16 Trench 38

- 4.16.1 A number of intercutting ditches and pits were encountered in Trench 38 (Fig. 6). A sufficient number of features was tested to characterise and date the activity encountered.
- 4.16.2 At the northern end of Trench 38 two intercutting pits (3803 and 3810) were investigated. The earlier of the two, 3803, measured 1.16m long, 0.64m wide and 0.29m deep, and had moderately sloping convex sides and a concave base. The pit contained a single sterile fill.
- 4.16.3 Pit 3810 measured 0.58m long, 0.45m wide and 0.11m deep, with steep sides and a slightly irregular base. No finds were recovered from the single fill.

- 4.16.4 To the southeast, a NE-SW aligned ditch (3808) crossed the trench, cutting unexcavated pit 3812 at the northern baulk end. The ditch measured 0.74m wide and 0.28m deep and had steep sides and a concave base. The single fill (3809) contained fragments of late Iron Age and early Roman pottery and ceramic building material, while fragments of late Iron Age pottery were recovered from the surface of pit 3812.
- 4.16.5 Pit 3806, to the south of ditch 3808, measured 0.81m long, 0.65m long and 0.14m deep. It had gently sloping sides and a flat base. A single fill (3807) produced fragments of late Bronze Age/early Iron Age pottery.
- 4.16.6 Fragments of late Iron Age pottery were also recovered from the surface of unexcavated ditch 3811, which crossed the centre of the trench on an E-W alignment.

## 4.17 Trench 39

- 4.17.1 Two postholes were encountered at the northern end of Trench 39 (Fig. 6). The northernmost one (3906), measured 0.52m long, 0.38m wide and 0.1m deep. It had moderately sloping sides and a concave base and was filled by a single, sterile deposit.
- 4.17.2 The second posthole (3908) measured 0.44m in diameter and 0.21m deep and had steep sides and a narrow, concave base. The feature contained a single sterile fill.
- 4.17.3 Four intercutting ditches investigated in the northern half of the trench broadly matched the alignment of a NE-SW-aligned cropmark. The earliest, southernmost of the four features was ditch 3910. It measured 0.49m wide and 0.18m deep. It had with a flat base and was filled by a single deposit (3911), which contained fragments of pottery. The feature was cut by a modern field drain and ditch 3912.
- 4.17.4 Ditch 3912 measured 0.72m wide and 0.21m deep. It had a steep side and flat base; a single fill (3913) contained fragments of a fired clay plate. This may have been a portable part of a kiln. The feature's northern side was cut by ditch 3914.
- 4.17.5 Ditch 3914 measured 0.72m wide and 0.38m deep. It had a V-shaped profile and contained a single fill (3915), in which middle Roman pottery fragments were recovered. The feature appears to be a recut of larger ditch 3916, which measured 0.84m wide and over 0.44m deep; due to excavation depth restrictions the base was not revealed. The ditch contained at least two fills (3917 and 3918), both of which produced fragments of late Iron Age/Roman pottery.

## 4.18 Trench 40

- 4.18.1 Four parallel running E-W aligned ditches were encountered at the southern end of Trench 40, matching the line of a linear cropmark (Figs 6 and 15 Section 4000).
- 4.18.2 The northernmost feature, ditch 4003, measured 1.29m wide and 0.32m deep and had moderately sloping sides and a concave base. The single fill (4004) produced an assemblage of early Roman pottery fragments.

- 4.18.3 Ditch 4008 was cut by on its northern side by ditch 4006 and on its southern side by ditch 4010. The remaining extent of the feature measured 1.1m wide and 0.41m deep. It had moderately sloping sides and a concave base. The single fill produced no finds.
- 4.18.4 Ditch 4006 measured 0.94m wide and 0.41m deep. It had steep sides and a concave base; the single fill contained fragments of early Roman pottery.
- 4.18.5 The terminus of shallow ditch 4010 measured 0.43m wide and 0.06m deep, and had moderately sloping sides and a flat base. No finds were recovered.
- 4.18.6 Two pits located near the middle of the trench remained unexcavated and were recorded in plan only.

## 4.19 Trench 42

- 4.19.1 Several intercutting linear and curvilinear ditches were encountered in Trench 42, with only some features corresponding to cropmarks (Fig. 7). Several features remain unexcavated, such as NE-SW aligned ditch 4210, from whose surface fragments of Roman pottery were collected.
- 4.19.2 Three intercutting features were investigated near the middle of the trench. Ditch 4202, the northernmost feature, crossed the trench on a NE-SW alignment. It measured 5.24m wide and at least 0.83m deep and had moderately sloping sides; due to excavation depth restrictions the base was not reached (Fig. 15 Section 4200). Fragments of late Iron Age pottery were recovered from fill 4203.
- 4.19.3 The feature was cut on its southern side by ditch 4204, which was also NE-SW-aligned. It measured 0.83m wide and 0.46m deep, and had steep sides and a narrow, concave base. A single fill (4205) contained fragments of Roman pottery.
- 4.19.4 Pit 4206, which was cut by ditch 4204, measured 0.72m long, 0.6m wide and 0.3m deep. It had steep sides and a concave base. No finds were recovered.

## 4.20 Trench 43

- 4.20.1 A total of eight roughly N-S aligned ditches were revealed in Trench 43, with four of the features recorded in plan only (Fig. 7). One of these, ditch 4315, contained a small assemblage of late Iron Age pottery, which was visible on the surface of the feature.
- 4.20.2 Intercutting ditches 4311 and 4313 were located near the western end of the trench. The earlier feature (4311) measured 0.66m wide and 0.22m deep and had moderately sloping sides and a concave base. It was filled by a single deposit (4312) containing a single sherd of Roman pottery.
- 4.20.3 The ditch was cut on its western side by ditch 4313, which measured 0.8m wide and 0.24m deep. It had irregular sides and a concave base. The feature was filled by a single deposit (4314), which produced Roman pottery.



- 4.20.4 Large, intercutting ditches 4304 and 4308 were investigated further to the east. Owing to the size of the features and excavation depth restrictions, neither ditch was fully excavated. The features align with a large linear cropmark.
- 4.20.5 The earlier feature, 4304, measured 3.24m wide and more than 0.5m deep. It had steep, possibly stepped sides, and at least three fills, with deposits 4306 and 4307 producing fragments of early-middle Roman pottery.
- 4.20.6 The western side of the feature was cut by ditch 4308, which measured 2.18m wide and 0.44m deep. It had steep sides and was filled by at least two deposits. The upper fill (4310) contained fragments of Roman pottery.

## 4.21 Trench 44

- 4.21.1 Six ditches and three discrete features were exposed in Trench 44, including several ditch lines which appeared to match some of the linear cropmarks (Fig. 7).
- 4.21.2 Pit 4410 at the western end of the trench measured 0.62m long, 0.42m wide and 0.12m deep. It had steep sides and a stepped base. Its single fill produced no finds.
- 4.21.3 At the opposite end of the trench, posthole 4408 measured 0.76m long, 0.5m wide and 0.32m deep. It had with near-vertical sides and a concave base. Its single fill (4409) contained several fragments of late Iron Age pottery.
- 4.21.4 Intercutting ditches 4403 and 4404 were encountered near the middle of the trench, running on a N-S alignment and roughly coinciding with a NNE-SSW aligned linear cropmark. The earlier feature, 4403, measured 1.16m wide and 0.3m deep. It had steep concave sides and a flat base and had been heavily affected by root disturbance. The ditch was filled by a single deposit (4402), which contained late Bronze Age/early Iron Age fragments of pottery as well as animal bone.
- 4.21.5 Ditch 4403 was cut on its western side by ditch 4404, which measured 0.74m wide and 0.28m deep and had steep sides and a concave base. Roman pottery fragments were recovered from its single fill (4405).
- 4.21.6 Ditch 4406, just to the east of the two intercutting ditches, was on a NNW-SSE alignment, matching another linear cropmark. The feature measured 1.3m wide and 0.72m deep and had steep sides and a narrow, concave base. Its single fill (4407) contained fragments of late Bronze Age/early Iron Age pottery.

## 4.22 Trench 45

- 4.22.1 A set of two postholes (4509 and 4511) was investigated near the middle of Trench 45 (Fig. 7). Posthole 4509 measured 0.5m long, 0.36m wide and 0.1m deep. It had vertical sides and a concave base (Fig. 15 Section 4501). A single fill (4510) proved to be sterile.
- 4.22.2 Posthole 4511, located slightly to the east, measured 0.45m in diameter and 0.14m deep. It had near-vertical sides and a flat base. The feature contained a single fill (4512), which produced no finds.

- 4.22.3 Ditch 4513, near the eastern end of the trench, was aligned along the same N-S axis as a narrow linear cropmark. The feature measured 1.3m wide and 0.4m deep. It had steep, slightly uneven sides and a flat base, and contained a primary slump deposit (4518) as well as a secondary fill (4514). Neither fill contained any finds.
- 4.22.4 Towards the western end of the trench, N-S-aligned ditch 4503 matched a large curvilinear cropmark possibly representative of an enclosure boundary. The feature measured 2.8m wide and more than 0.5m deep (Fig. 15 Section 4500). It had steep, slightly stepped sides; due to excavation depth restrictions the base was not reached. Two deposits were observed within the ditch, but neither contained any finds.
- 4.22.5 The line of the ditch was recut by ditch 4507, which measured 0.7m wide and more than 0.5m deep. The feature contained two fills (4504 and 4508), both of which contained late Iron Age/early Roman pottery.
- 4.22.6 An unexcavated discrete feature (4519) at the western end of the trench also produced Roman pottery, collected from its surface.

## 4.23 Trench 46

- 4.23.1 A scatter of small discrete features was observed in the northern half of Trench 46 (Fig. 7); three postholes were chosen for hand-excavation while the rest were recorded in plan only.
- 4.23.2 Posthole 4602 measured 0.46m wide and 0.09m deep. It had steep sides and a flat, slightly uneven base. The shallow feature was filled by a single deposit which contained no finds.
- 4.23.3 Posthole 4613, measured 0.38m long, 0.3m wide and 0.14m deep. It had steep sides and a slightly concave base. The feature contained a single sterile fill.
- 4.23.4 Posthole 4604 measured 0.46m in diameter and 0.34m deep. It had near-vertical sides and a concave base. No finds were recovered from the single fill.
- 4.23.5 In the southern half of the trench, E-W aligned ditch 4606 matched the alignment of a linear cropmark. A modern field drain extended along the feature's northern side. The ditch itself measured 1.86m wide and over 0.56m deep; due to excavation depth restrictions, the base of the feature was not reached. It had slightly stepped sides. Its single fill (4607) produced fragments of middle Roman pottery.
- 4.23.6 The feature was recut by ditch 4624, which measured approximately 1.1m wide and 0.38m deep. It had steep sides and a concave base. The single fill (4609) contained fragments of middle Iron Age pottery.
- 4.23.7 To the south, ditch 4615 extended across the trench on an E-W alignment, matching a linear cropmark. The feature measured 1.1m wide and 0.47m deep and had near-vertical sides and a concave base. The single fill (4608) contained fragments of early Roman Pottery.

## 4.24 Trench 47

- 4.24.1 At the western end of the trench, NW-SE-aligned ditch 4703 matched a linear cropmark (Fig. 7). The feature measured 0.84m wide and 0.28m deep. It contained steep sides and a flat base and contained two sterile fills.
- 4.24.2 Two intercutting NW-SE-aligned ditches were encountered at the eastern end of the trench. These are likely to represent a cropmark linear feature and its recut. The earliest cut (4706) measured 0.9m wide and more than 0.52m deep; due to excavation depth restrictions the base was not reached (Fig. 16 Section 4701). The ditch contained a sequence of fills, with only fill 4709 producing fragments of late Bronze Age/early Iron Age pottery. The ditch was recut by 4712, which measured 0.8m wide and more than 0.52m deep. It had steep sides and contained two sterile fills.
- 4.24.3 The feature was recut a second time by ditch 4712. It measured 0.98m wide and 0.56m deep and had steep sides and a flat base. The ditch was filled by two deposits, the upper fill (4714) containing late Iron Age pottery.

## 4.25 Trench 48

- 4.25.1 Trench 48 contained a single E-W aligned ditch at its southern end (Fig. 8). The feature measured 0.8m wide and 0.28m deep. It had steep sides and a flat base, and was filled by a single sterile deposit.

## 4.26 Trench 49

- 4.26.1 Trench 49 contained three parallel NW-SE-aligned ditches. Ditch 4903, the easternmost feature, matched one of the cropmarks. It measured 1.26m wide and 0.44m deep and had steep sides and a concave base. A single fill (4904) produced fragments of early Roman pottery.
- 4.26.2 Ditch 4905, two metres further west, measured 0.4m wide and 0.14m deep. It had steep sides and a flat base and was filled by a single deposit, which contained no finds. The feature did not match any cropmarks.
- 4.26.3 The westernmost of the three features, ditch 4907, matched another linear cropmark. The ditch measured 1.42m wide and 0.44m deep and had steep sides, with a slight step on the western side leading onto a flat base. A single fill (4908) contained one sherd of late Bronze Age/early Iron Age pottery.

## 4.27 Trench 50

- 4.27.1 Trench 50 exposed a single E-W aligned ditch terminus or possible pit (5003), which did not correspond to any cropmarks (Fig. 9). The feature measured 0.96m wide and 0.26m deep. It had moderately steep sides and a flat base and contained a single sterile fill.

## 4.28 Trench 52

- 4.28.1 A single ditch (5203), which was orientated E-W, was investigated in Trench 52 (Fig. 9). The feature measured 0.64m wide and 0.14m deep. It had moderately sloping sides and a concave base. No finds were recovered from the single fill.

## 4.29 Trench 53

- 4.29.1 Two natural features were tested and confirmed as geological variations in Trench 53 (Fig. 9); these features broadly matched some of the discrete cropmarks in the area.
- 4.29.2 A pit (5302) near the centre of the trench measured 1.26m long, 0.41m wide and 0.28m deep. It had moderately sloping, slightly irregular sides and a slightly irregular base.
- 4.29.3 Pit 5304 was located at the northern end of the trench. It measured 1.26m long, 0.28m wide and 0.41m deep. It had moderately steep sides and a concave base. The feature contained a single fill which produced two small fragments of modern china.

## 4.30 Trench 56

- 4.30.1 Three ditches running on a N-S alignment were encountered in Trench 56 (Fig. 9). All three are likely to represent continuations of the features investigated in Trench 49 to the north.
- 4.30.2 Ditch 5603 was the easternmost of the three features. It measured 1.26m wide and 0.36m deep. It had steep sides and a concave base. The single fill (5604) contained a number of Roman pottery fragments. The feature matched a linear cropmark.
- 4.30.3 Just to the west, ditch 5605 measured 0.54m wide and 0.18m deep. It had steep, concave sides and a concave base. The single fill contained no finds, and the feature did not match any cropmarks.
- 4.30.4 The westernmost feature, ditch 5607, corresponded to another linear cropmark. The ditch measured 1.58m wide and 0.46m deep. It had a steep eastern side and a concave western side, leading to a concave base. The feature contained two fills, but only the upper deposit (5609) contained finds in the form of fragments of ceramic building material.

## 4.31 Trench 60

- 4.31.1 Trench 60 (Fig. 10) revealed a slightly irregular ditch (6003) running on a N-S alignment. It measured 1.2m wide and 0.47m deep and had steep sides and a concave base. The feature contained four fills, but none produced any finds.
- 4.31.2 Further to the east, ditch 6008 crossed the trench on a parallel alignment and matched the line of a cropmark. Ditch 6008 measured 0.9m wide and 0.48m deep, with steep sides and a concave base. Ceramic fragments dating to the late Bronze Age to middle Iron Age were recovered from each of the two fills (6009 and 6010).
- 4.31.3 Two possible pits were only partially exposed within the trench; these remained unexcavated.

## 4.32 Trench 61

- 4.32.1 Trench 61 was targeted to investigate a large cropmark that appeared irregular in plan with a general E-W alignment. Excavation did not encounter any significant deposits that may account for this cropmark, although a series of soil marks were present that were sample excavated (Fig. 10).
- 4.32.2 A shallow E-W aligned linear feature (6105) measured 0.72m wide and 0.14m deep and had moderately steep sides and a flat base; the cut was heavily affected by root disturbance. A single fill contained no finds.
- 4.32.3 A number of irregular areas of natural variation were also observed, with one area tested by hand-excavation to confirm their character (6103).

## 4.33 Trench 62

- 4.33.1 Trench 62 revealed a single E-W aligned ditch (6203) which matched a linear cropmark (Fig. 10). The feature measured 1.4m wide and more than 0.5m deep; due to excavation depth restrictions the base was not reached (Fig. 16 Section 6200). Some fragments of middle Iron Age pottery, as well as a fragment of iron were recovered from the single fill (6204).

## 4.34 Trench 63

- 4.34.1 A small posthole (6303) was encountered in Trench 63 (Fig. 10). The feature measured 0.6m long, 0.3m wide and 0.25m deep, with vertical sides and a concave base, and contained a single fill (6304) which produced fragments of late Bronze Age/early Iron Age pottery.
- 4.34.2 Slightly further south, a second, similar sized possible feature was tested, but it was concluded that this was the result of natural disturbance and of no archaeological significance.

## 4.35 Trench 64

- 4.35.1 The terminus of a NW-SE aligned ditch extended into Trench 64 from the southern baulk (Fig. 11). The feature measured 0.7m wide and 0.27m deep. It had a steep north-east side and a slightly stepped southwest side leading onto a concave base. No finds were recovered from the single fill.
- 4.35.2 A shallow pit (6405) was investigated close to the eastern end of the trench. The feature measured 0.4m in diameter and 0.11m deep. It had a steep western side and a stepped side to the east, leading onto a concave base. A single fill contained no artefactual material.
- 4.35.3 Immediately to the north of the pit, an area of root disturbance was investigated; this was found to have no archaeological significance.

## 4.36 Trench 66

- 4.36.1 Near the eastern end of Trench 66 a small unurned cremation pit (6604) was encountered. It measured 0.36m long, 0.31m wide and 0.12m deep and had vertical sides and a concave base (Fig. 16 Section 6600). The cremated remains were excavated, recorded and lifted in full; a detailed assessment can be found in Appendix C.

## 4.37 Trench 69

- 4.37.1 A single NE-SW aligned ditch (6903) was encountered in Trench 69 (Fig. 12). It measured 0.85m wide and 0.23m deep and had moderately sloping sides and a concave base (Fig. 17 Section 6900). The feature contained two fills, with the basal deposit (6904) producing worked flint fragments.

## 4.38 Trench 70

- 4.38.1 Three parallel NW-SE aligned ditches were encountered in Trench 70, but only the westernmost feature (7003), matching a linear cropmark, was selected for hand-investigation (Fig. 12). The ditch measured 1.41m wide and 0.19m deep and had moderately sloping sides and a flat base. It contained a single sterile fill.

## 4.39 Trench 73

- 4.39.1 The terminus of a small, roughly N-S aligned ditch was investigated in Trench 73, extending into the trench from the northern baulk section. The feature measured 0.56m wide and 0.14m deep and had steep sides and a concave base. A single fill contained no finds. While the feature does not directly overlap with any cropmarks, it may represent the continuation of a cropmark and matching ditch observed further to the north, recorded in plan in Trench 44 (feature 4414).
- 4.39.2 An area of natural variation was observed within the trench but remained unexcavated due to its morphological similarity to previously tested natural features.

## 4.40 Trench 75

- 4.40.1 A posthole (7503) was investigated near the northern end of the trench (Fig. 13), measuring 0.38m in diameter and 0.2m deep. It had steep, slightly concave sides and a concave base. The feature contained a single fill (7504), which produced one fragment of late bronze Age/early Iron Age pottery.
- 4.40.2 Three intercutting ditches on two alignments were revealed near the middle of the trench, roughly matching two NE-SW and NW-SE aligned linear cropmarks. Ditch 7514, the most recent of the three features, measured 2.42m wide and more than 0.38m deep; due to excavation depth restrictions the base of the feature was not reached. The feature had a concave northern side and a convex western side. The feature was filled by at least one deposit, which produced late Bronze Age/early Iron Age pottery fragments, but was heavily disturbed by roots and a modern field drain, which may be responsible for introducing the fragments of post-medieval ceramics which were also recovered.
- 4.40.3 The line of the ditch partially cuts smaller ditch 7510, running on the same alignment. The feature measured 0.7m wide and more than 0.16m deep. It had steep sides and a single fill, from which no finds were recovered.
- 4.40.4 Ditch 7510 was also cut by ditch 7512, running on a NW-SE alignment across the trench. The ditch measured 0.7m wide and 0.16m deep. It had

steep, slightly concave sides and an irregular base. The single fill produced no finds.

- 4.40.5 In the southern half of the trench, ditch 7505 was recorded on a NW-SE alignment. The feature measured 0.64m wide and 0.34m deep and had steep sides and a narrow, concave base. It contained two fills. The upper deposit (7506) produced fragments of late Bronze Age/early Iron Age pottery.
- 4.40.6 Just to the south, possible ditch terminus 7508 was only partially exposed against the northern baulk section. The feature's visible extent measured 0.76m wide and 0.34m deep. It had moderately sloping sides and a slightly irregular base. The single fill (7509) contained fragments of early iron Age pottery, flint and burnt stone.

## 4.41 Trench 76

- 4.41.1 Two ditches were investigated in Trench 76 (Fig. 13). The southernmost feature, ditch 7605, measured 2.74m wide and more than 0.58m deep; due to excavation depth restrictions the base was not excavated (Fig. 17 Section 7600). The steep-sided feature contained at least two fills, with the lower fill (7606; possibly representative of a deliberate dump deposit) producing fragments of Roman pottery, while the upper fill (7607) produced late Iron Age ceramic fragments. The feature appears to align roughly with a slightly curvilinear cropmark.
- 4.41.2 Slightly to the north, a smaller, slightly curvilinear ditch (7603) running on an E-W alignment was investigated. The feature measured 0.34m wide and 0.14m deep, with steep sides and a flat base, and contained a single fill which included fragments of early/middle Iron Age pottery.

## 4.42 Finds summary

- 4.42.1 **Prehistoric pottery.** Some 289 sherds (3193g) of prehistoric pottery were collected from 14 trenches. The entirety of the material could be accommodated within the date range c 1150-50 cal BC, covering the late Bronze Age to middle Iron Age. At least three sequential periods were represented by diagnostic material: the late Bronze Age/earliest Iron Age (c 1000-600 cal BC), early Iron Age (c 600-350 cal BC) and middle Iron Age (c 350-50 cal BC).
- 4.42.2 **Late Iron Age and Roman pottery.** The pottery spans the late Iron Age and Roman periods, with a strong focus on the late Iron Age to early Roman period. The material from this period includes hand-made vessels in the Iron Age tradition, including bead-rimmed jars/bowls in sand and shell tempered fabrics and 'Belgic' forms in sand and grog-tempered fabrics. These contexts have a fairly wide date range spanning the 1st century AD. Some contexts that also contain similar material have been assigned a more specific early Roman date, as they were accompanied by 'romanised' greywares of post-conquest date. It is possible that all the late Iron Age to early Roman phased material is also early Roman in date, representing a single main phase of activity on the site associated with the enclosures in the north of the evaluated area.

- 4.42.3 The small amount of material recovered from the middle and late Roman periods may represent the continued use of the enclosures after they had been substantially infilled or modification of the enclosure system.
- 4.42.4 **Fired clay.** The fired clay is predominantly of late Iron Age-early Roman date and provides evidence of craft/industrial activities undertaken in the area. The material includes a significant quantity of kiln debris, comprising both structural and portable items, which attest to the presence of one or more pottery kilns in the area. The focal area for pottery production is Trench 36, together with evidence in Trenches 38, 43 and 44.
- 4.42.5 The fired clay also includes material that may relate to salt production, focused on Trench 17. Although the site lies nearly 4km from the coast, any settlement in the area may have access to the Thames estuary and conducted seasonal activities along the shoreline.
- 4.42.6 **Clay pipe.** A single small fragment of late 18th to 19th century clay pipe was recovered in Trench 47.
- 4.42.7 **Stone.** A total of 29 pieces of burnt stone were recovered from Trenches 17, 76, and 38. Only one fragment, a piece of burnt gritstone from Trench 38, appears to have a worked surface and could be a piece of quern, but is too small for certain identification.
- 4.42.8 **Metal.** A total of 14 objects, including 13 iron objects and 1 copper alloy object, were recovered as part of the evaluation. The finds are generally poorly preserved and affected by corrosion, with the exception of the copper alloy needle or hair pin. Iron objects recovered include a number of various nails, iron rods or bars, a possible leaf-shaped blade and a possible key fragment.
- 4.42.9 Two small smithing hearth bottoms were recovered from Trench 19, and two small pieces of probable fuel ash slag from Trench 20, providing an indication that some low level of smithing was carried out within the site.



## 4.43 Environmental summary

- 4.43.1 **Cremated human remains.** The assemblage comprises one unurned burnt bone deposit (6605), consisting of one juvenile of under 16.5 years, most likely an adolescent (13-17 years) or older child (6-12 years). Overall, the recovered bones were well burnt and predominantly white (fully oxidised), indicating high pyre temperatures. The relatively low total weight (180.8g) of the assemblage suggests a token deposit rather than a complete burial.
- 4.43.2 **Environmental samples.** The samples largely date to between the late Bronze Age and the early Roman period. The condition and quantity of the charred plant material varies across the site, and the poor preservation of some of the charred material, is probably largely related to pre-depositional processes. Most of the samples which have produced diverse charred plant assemblages originate from the northernmost part of the site, along Stifford Clays Road. It seems likely that the main settlement area, or at least the features related to food production or crop processing, were located in this area, either in this northern part of the evaluation area or in the field to the north.

## 5 Discussion

---

### 5.1 Reliability of field investigation

- 5.1.1 The archaeological features were reasonably well defined against the underlying Boyn Hill Gravel, although some deposits were sample excavated to establish if they were of geological or archaeological significance. In all examples, hand-excavation confirmed the initial interpretations.
- 5.1.2 There was a correlation between the aerial survey cropmarks and the archaeological features in several trenches, particularly in the northern portion of the site. A number of possible enclosures and trackways were encountered which matched the cropmark data, although the density and quantity of pit features was lower than expected, with many of the discrete cropmarks originating from geological variation.
- 5.1.3 This continues the trend from previous land parcels where these cropmarks have, at most, been indicative of geological changes. Nevertheless, the cropmarks appeared to map linear alignments with some level of accuracy particularly in the busiest area of the site.

### 5.2 Interpretation

- 5.2.1 **Bronze Age to early/middle Iron Age.** Bronze Age and earlier Iron Age dating evidence was derived mainly from features within the northern part of the site, in the same general areas which also showed evidence for later occupation. The curvilinear ring-ditches encountered within the site remain undated, but it is possible that they may represent truncated and disturbed remains of Bronze Age barrows or other activity of this era.
- 5.2.2 It appears that the site itself and the surrounding area were occupied in some way relatively continuously from the Bronze Age to the Roman period.
- 5.2.3 **Late Iron Age and Roman.** Features dating to the Late Iron Age/Romano-British transition period were encountered in Trenches 16, 17, 36-40, 42-47, 56, 75, and 76. The majority of these features matched cropmark and appeared to represent large enclosures and trackways.
- 5.2.4 It is likely that the activity is related to a farmstead site encountered previously during works in the 1980s, roughly 500m to the west of the site. This would imply that the late Iron Age and Roman features may have formed part of the agriculturally exploited hinterland of the farmstead settlement; the re-cutting of enclosure ditches suggests a level of stability and continuity over a considerable period of time.
- 5.2.5 A range of activities are represented by the artefactual assemblages from this period with some evidence for pottery production on or near to the site suggested by the remains of kiln furniture, smithing represented by two small hearth bottoms and salt production or trade also being represented by specific fired clay objects.

- 5.2.6 **Undated.** A number of undated features, predominantly smaller ditches and postholes or small pits, were also encountered during the course of the fieldwork. These may relate to the prehistoric or Roman activity within the site, but could alternatively represent later, medieval activity.
- 5.2.7 **Natural features.** The evaluation encountered high proportions of root disturbance particularly around the edges of the site in proximity to hedge rows and/or tree lines marking the edge of the field. In addition, the fieldwork confirmed again that, similar to previous land parcels, the large discrete cropmarks appear to be of natural origin in the form of variations in the natural geology.

### 5.3 Evaluation objectives and results

- 5.3.1 This evaluation established the presence of archaeological remains and investigated their character by analysing artefacts and environmental evidence. The evaluation also ground-truthed the cropmark evidence as identified by the 2019 aerial survey (Place Services 2019) and investigated the apparently blank areas where no cropmarks had been identified.
- 5.3.2 The evaluation was conducted within the general research parameters and objectives defined by the revised East of England Research Framework (Medlycott 2011). The aims and objectives outlined in the WSI were devised in line with those of the Greater Thames Estuary Historic Environment Research Framework. Therefore, where the WSI aims have been fulfilled it also follows that those within the regional research framework have also been addressed. These results are, of course, set within the limitations of an evaluation where detailed interpretations are often difficult to apply with confidence.
- 5.3.3 In terms of specific objectives, the evaluation found some evidence of later Bronze Age activity within the site. A number of pottery fragments were recovered from a variety of features, although no evidence was seen for any activity relating to potential monuments within the site or close vicinity. Notably, in Trench 36 the remains of a large shouldered jar were recovered, and it appears that, while fragmented, the vessel remained mostly complete.
- 5.3.4 The cremated human remains were found in the south-east portion of the site, in a relatively isolated area away from other archaeological features, and notably some distance from the circular cropmarks which had been presumed to be possible Bronze Age barrows.
- 5.3.5 The evaluation also found evidence of late Iron Age and early Roman activity within the site, particularly in the northern portion of the site along what is now Stifford Clays Road. It is likely that this phase of activity accounts for the majority of enclosure and trackway shaped cropmarks, suggesting a level of agricultural exploitation linked to a farmstead or small settlement.
- 5.3.6 Most of the enclosure ditches which were investigated as part of the fieldwork showed evidence of having been re-cut and/or re-established at least once. This seems to be an indication that the field systems were in

use for a considerable period of time with little major restructuring or reorganisation of the landscape.

- 5.3.7 Although no direct dating evidence was recovered, it is possible that the remains of a N-S aligned former field boundary, marked on the 1st Edition Ordnance Survey map, was encountered in Trenches 17, 23, and 30.

## Appendix A Trench Tables

| <b>Trench 1</b>   |       |         |           |           |  |         |      |
|---|-------|---------|-----------|-----------|--|---------|------|
| General description   |       |         |           |           | Orientation  | NE - SW |      |
| Trench revealed single boundary consisting of two ditches. Ploughsoil and subsoil overlying natural geology of clay and gravel. |       |         |           |           | Length (m)   | 30      |      |
|   |       |         |           |           | Width (m)  | 2.2     |      |
|   |       |         |           |           | Avg. depth (m)   | 0.48    |      |
| Context No.   | Type  | Fill Of | Width (m) | Depth (m) | Description  | Finds   | Date |
| 100   | Layer |         |           |           | Ploughsoil   |         |      |
| 101   | Layer |         |           |           | Subsoil  |         |      |
| 102   | Layer |         |           |           | Natural  |         |      |
| 103   | Cut   |         | 0.4       | 0.16      | Ditch  |         |      |
| 104   | Fill  | 103     | 0.4       | 0.16      | Secondary Fill. Light Greyish Brown, Sandy Silt, Gravel - Rare   |         |      |
| 105   | Cut   |         | 1.4       | 0.64      | Ditch  |         |      |
| 106   | Fill  | 105     | 0.9       | 0.36      | Secondary Fill. Mid Bluish Grey, Silty Clay, Infrequent Gravel   |         |      |
| 107   | Fill  | 105     | 1.4       | 0.28      | Secondary Fill. Mid Greyish Brown, Sandy Silt, Infrequent Gravel |         |      |
| <b>Trench 2</b>   |       |         |           |           |  |         |      |
| General description   |       |         |           |           | Orientation  | E-W     |      |
| Trench devoid of archaeology. Consists of ploughsoil and subsoil overlying natural geology of clayey sand and gravel.           |       |         |           |           | Length (m)   | 20      |      |
|   |       |         |           |           | Width (m)  | 10      |      |
|   |       |         |           |           | Avg. depth (m)   | 0.5     |      |
| Context No.   | Type  | Fill Of | Width (m) | Depth (m) | Description  | Finds   | Date |
| 200   | Layer |         |           | 0.33      | Ploughsoil. Dark grey brown, clayey sand                         |         |      |
| 201   | Layer |         |           | 0.18      | Subsoil. Mid orange brown, clayey sand                           |         |      |
| 202   | Layer |         |           |           | Natural. Mid brown orange, clayey sand with gravel               |         |      |
| <b>Trench 3</b>   |       |         |           |           |  |         |      |
| General description   |       |         |           |           | Orientation  | NE-SW   |      |
| Trench devoid of archaeology. Consists of ploughsoil overlying a natural geology of clay gravels.                               |       |         |           |           | Length (m)   | 30      |      |
|   |       |         |           |           | Width (m)  | 2       |      |
|   |       |         |           |           | Avg. depth (m)   | 0.32    |      |
| Context No.   | Type  | Fill Of | Width (m) | Depth (m) | Description  | Finds   | Date |

|  |       |         |           |           |   |       |      |
|--|-------|---------|-----------|-----------|---|-------|------|
| 300  | Layer |         |           | 0.28      | Ploughsoil. Mid brownish grey, clayey sand.           |       |      |
| 301  | Layer |         |           |           | Natural. Mid orangey brown, clayey sand with gravels. |       |      |
| <b>Trench 4</b>  |       |         |           |           |   |       |      |
| General description  |       |         |           |           | Orientation   | E - W |      |
| Trench devoid of archaeology. Consists of plough soil and sub soil overlying a natural geology of clay gravel.                 |       |         |           |           | Length (m)  | 30    |      |
|  |       |         |           |           | Width (m)   | 2.2   |      |
|  |       |         |           |           | Avg. depth (m)  | 0.4   |      |
| Context No.  | Type  | Fill Of | Width (m) | Depth (m) | Description   | Finds | Date |
| 400  | Layer |         |           | 0.28      | Ploughsoil. Dark grey brown silty clay.               |       |      |
| 401  | Layer |         |           | 0.12      | Subsoil. Mid orange brown silty clay.                 |       |      |
| 402  | Layer |         |           |           | Natural. Mid brown orange clay gravel.                |       |      |
| <b>Trench 5</b>  |       |         |           |           |   |       |      |
| General description  |       |         |           |           | Orientation   | N-S   |      |
| Trench devoid of archaeology. Consists of ploughsoil and subsoil over natural geology of silty sand and gravel.                |       |         |           |           | Length (m)  | 30    |      |
|  |       |         |           |           | Width (m)   | 2     |      |
|  |       |         |           |           | Avg. depth (m)  | 0.45  |      |
| Context No.  | Type  | Fill Of | Width (m) | Depth (m) | Description   | Finds | Date |
| 500  | Layer |         |           | 0.3       | Ploughsoil. Brownish grey, sandy silt                 |       |      |
| 501  | Layer |         |           | 0.15      | Subsoil. Light yellowish grey, sandy silt             |       |      |
| 502  | Layer |         |           |           | Natural. Orangey yellow silty sand and gravel         |       |      |
| <b>Trench 6</b>  |       |         |           |           |   |       |      |
| General description  |       |         |           |           | Orientation   | W-E   |      |
| Trench revealed one ring ditch and one discrete. Ploughsoil overlaying natural geology consisting of clayey sand with gravels. |       |         |           |           | Length (m)  | 30    |      |
|  |       |         |           |           | Width (m)   | 2     |      |
|  |       |         |           |           | Avg. depth (m)  | 0.4   |      |
| Context No.  | Type  | Fill Of | Width (m) | Depth (m) | Description   | Finds | Date |
| 600  | Layer |         |           | 0.3       | Ploughsoil. Mid brownish grey, clayey sand.           |       |      |
| 601  | Layer |         |           |           | Natural. Mid orangey brown, clayey sand with gravels. |       |      |

|     |      |     |          |      |   |  |  |
|-----|------|-----|----------|------|---|--|--|
| 602 | Cut  |     | 1.3<br>3 | 0.37 | Ring Ditch  |  |  |
| 603 | Fill | 602 | 1.3<br>3 | 0.37 | Secondary Fill. Light-mid greyish brown, sandy clay |  |  |
| 604 | Cut  |     | 1.8<br>4 | 0.2  | Pit   |  |  |
| 605 | Fill | 604 | 1.8<br>4 | 0.2  | Secondary Fill. Light greyish brown, clayey sand    |  |  |

### Trench 7

| General description  |       |         |           |           | Orientation                             | N - S |      |
|--|-------|---------|-----------|-----------|---|-------|------|
| Trench devoid of archaeology. Consists of ploughsoil and subsoil overlying a natural geology of clay gravel. |       |         |           |           | Length (m)                              | 30    |      |
|  |       |         |           |           | Width (m)                               | 2.2   |      |
|  |       |         |           |           | Avg. depth (m)                          | 0.42  |      |
| Context No.  | Type  | Fill Of | Width (m) | Depth (m) | Description                             | Finds | Date |
| 700  | Layer |         |           | 0.28      | Ploughsoil. Dark grey brown silty clay. |       |      |
| 701  | Layer |         |           | 0.14      | Subsoil. Mid orange brown silty clay.   |       |      |
| 702  | Layer |         |           |           | Natural. Mid brown orange clay gravel.  |       |      |

### Trench 8

| General description   |       |         |           |           | Orientation                            | E - W |      |
|---|-------|---------|-----------|-----------|--|-------|------|
| Trench devoid of archaeology. Consists of plough soil and sub soil overlying a natural geology of clay gravel |       |         |           |           | Length (m)                             | 30    |      |
|   |       |         |           |           | Width (m)                              | 2.2   |      |
|   |       |         |           |           | Avg. depth (m)                         | 0.4   |      |
| Context No.   | Type  | Fill Of | Width (m) | Depth (m) | Description                            | Finds | Date |
| 800   | Layer |         |           | 0.28      | Ploughsoil. Dark grey brown silty clay |       |      |
| 801   | Layer |         |           | 0.12      | Subsoil. Mid orange brown silty clay.  |       |      |
| 802   | Layer |         |           |           | Natural. Mid brown orange clay gravel. |       |      |

### Trench 9

| General description  |      |         |           |           | Orientation    | N-S   |      |
|--|------|---------|-----------|-----------|----------------|-------|------|
| Trench devoid of archaeology. Consists of ploughsoil overlying a natural geology of clay gravel. |      |         |           |           | Length (m)     | 30    |      |
|  |      |         |           |           | Width (m)      | 2     |      |
|  |      |         |           |           | Avg. depth (m) | 0.32  |      |
| Context No.  | Type | Fill Of | Width (m) | Depth (m) | Description    | Finds | Date |

|     |       |  |  |     |   |  |  |
|-----|-------|--|--|-----|---|--|--|
| 900 | Layer |  |  | 0.3 | Ploughsoil. Mid brownish grey, clayey sand.           |  |  |
| 901 | Layer |  |  |     | Natural. Mid orangey brown, clayey sand with gravels. |  |  |

### Trench 10

|  |  |  |  |                |       |
|--|--|--|--|----------------|-------|
| General description  |  |  |  | Orientation    | NW-SE |
| Trench revealed one pit. Consists of ploughsoil overlying natural geology of clayey sand with gravels. |  |  |  | Length (m)     | 30    |
|  |  |  |  | Width (m)      | 2     |
|  |  |  |  | Avg. depth (m) | 0.25  |

| Context No. | Type  | Fill Of | Width (m) | Depth (m) | Description   | Finds | Date |
|-------------|-------|---------|-----------|-----------|---|-------|------|
| 1000        | Layer |         |           | 0.25      | Ploughsoil. Mid brownish grey, clayey sand.           |       |      |
| 1001        | Layer |         |           |           | Natural. Mid orangey brown, clayey sand with gravels. |       |      |
| 1002        | Cut   |         | 0.4<br>3  | 0.22      | Pit   |       |      |
| 1003        | Fill  | 1002    | 0.4<br>3  | 0.22      | Secondary Fill. Mid-dark brownish grey, sandy clay    |       |      |

### Trench 11

|  |  |  |  |                |       |
|--|--|--|--|----------------|-------|
| General description  |  |  |  | Orientation    | NW-SE |
| Trench contains one tree throw. Ploughsoil overlying natural geology consisting of clayey sand with gravels. |  |  |  | Length (m)     | 15    |
|  |  |  |  | Width (m)      | 15    |
|  |  |  |  | Avg. depth (m) | 0.35  |

| Context No. | Type  | Fill Of | Width (m) | Depth (m) | Description  | Finds | Date |
|-------------|-------|---------|-----------|-----------|--|-------|------|
| 1100        | Layer |         |           | 0.3       | Ploughsoil. Mid brownish grey, clayey sand           |       |      |
| 1101        | Layer |         |           |           | Natural. Mid orangey brown, clayey sand with gravels |       |      |
| 1102        | Cut   |         | 2.2<br>6  | 0.22      | Tree Throw   |       |      |
| 1103        | Fill  | 1102    | 2.2<br>6  | 0.22      | Secondary Fill. Mid Greyish Brown, Sandy Clay        |       |      |

### Trench 12

|  |  |  |  |                |       |
|--|--|--|--|----------------|-------|
| General description  |  |  |  | Orientation    | NW-SE |
| Trench devoid of archaeology. Ploughsoil overlying natural geology consisting of clayey sand with gravels. |  |  |  | Length (m)     | 30    |
|  |  |  |  | Width (m)      | 2     |
|  |  |  |  | Avg. depth (m) | 0.35  |

| Context No. | Type | Fill Of | Width (m) | Depth (m) | Description | Finds | Date |
|-------------|------|---------|-----------|-----------|-------------|-------|------|
|-------------|------|---------|-----------|-----------|-------------|-------|------|



| 1200   | Layer |         |           | 0.25      | Ploughsoil. Mid brownish grey, clayey sand.           |         |      |
|--|-------|---------|-----------|-----------|---|---------|------|
| 1201   | Layer |         |           |           | Natural. Mid orangey brown, clayey sand with gravels. |         |      |
| <b>Trench 13</b>   |       |         |           |           |   |         |      |
| General description  |       |         |           |           | Orientation   | NE - SW |      |
| Trench devoid of archaeology. Consists of ploughsoil and subsoil overlying a natural geology of clay gravel.           |       |         |           |           | Length (m)  | 30      |      |
|  |       |         |           |           | Width (m)   | 2       |      |
|  |       |         |           |           | Avg. depth (m)  | 0.44    |      |
| Context No.  | Type  | Fill Of | Width (m) | Depth (m) | Description   | Finds   | Date |
| 1300   | Layer |         |           | 0.3       | Ploughsoil. Dark grey brown clay silt                 |         |      |
| 1301   | Layer |         |           | 0.14      | Subsoil. Mid orange brown silty clay                  |         |      |
| 1302   | Layer |         |           |           | Natural. Light mid brown orange clay gravel.          |         |      |
| <b>Trench 14</b>   |       |         |           |           |   |         |      |
| General description  |       |         |           |           | Orientation   | NE - SW |      |
| Trench devoid of archaeology. Consists of plough soil and sub soil overlying a natural geology of clay gravel.         |       |         |           |           | Length (m)  | 30      |      |
|  |       |         |           |           | Width (m)   | 2.2     |      |
|  |       |         |           |           | Avg. depth (m)  | 0.4     |      |
| Context No.  | Type  | Fill Of | Width (m) | Depth (m) | Description   | Finds   | Date |
| 1400   | Layer |         |           | 0.3       | Ploughsoil. Dark grey brown silt clay                 |         |      |
| 1401   | Layer |         |           | 0.1       | Subsoil. Mid orange brown silty clay                  |         |      |
| 1402   | Layer |         |           |           | Natural. Mid brown orange clay gravel.                |         |      |
| <b>Trench 15</b>   |       |         |           |           |   |         |      |
| General description  |       |         |           |           | Orientation   | NE-SW   |      |
| Trench devoid of archaeology. Consists of ploughsoil and subsoil overlying natural geology of clayey sand and gravels. |       |         |           |           | Length (m)  | 30      |      |
|  |       |         |           |           | Width (m)   | 2.1     |      |
|  |       |         |           |           | Avg. depth (m)  | 0.39    |      |
| Context No.  | Type  | Fill Of | Width (m) | Depth (m) | Description   | Finds   | Date |
| 1500   | Layer |         |           | 0.3       | Ploughsoil. Dark grey brown, clayey silt              |         |      |
| 1501   | Layer |         |           | 0.09      | Subsoil. Mid grey brown, silty clay                   |         |      |
| 1502   | Layer |         |           |           | Natural. Mid orange brown, clayey gravelly sand       |         |      |

| 1503   | Void  |         |           |           |  |       |      |
|--|-------|---------|-----------|-----------|--|-------|------|
| <b>Trench 16</b>   |       |         |           |           |  |       |      |
| General description  |       |         |           |           | Orientation  | NE-SW |      |
| Three parallel linear (possibly part of same feature) and one narrow gully. Consists of ploughsoil and subsoil overlying natural geology of clayey sand and gravels.   |       |         |           |           | Length (m)   | 30    |      |
|  |       |         |           |           | Width (m)  | 2.1   |      |
|  |       |         |           |           | Avg. depth (m)   | 0.44  |      |
| Context No.  | Type  | Fill Of | Width (m) | Depth (m) | Description  | Finds | Date |
| 1600   | Layer |         |           | 0.32      | Ploughsoil. Dark grey brown, clayey silt   |       |      |
| 1601   | Layer |         |           | 0.12      | Subsoil. Mid grey brown, clayey silt   |       |      |
| 1602   | Layer |         |           |           | Natural. Mid orange brown, clayey gravelly sand  |       |      |
| 1603   | Cut   |         | 0.6<br>6  | 0.27      | Ditch  |       |      |
| 1604   | Fill  | 1603    | 0.6<br>6  | 0.27      | Primary Fill. Mid pink grey clay sand. Moderately compact. Friable. ~15% flint gravel. |       |      |
| 1605   | Cut   |         | 0.7       | 0.26      | Ditch  |       |      |
| 1606   | Fill  | 1605    | 0.7       | 0.26      | Primary Fill. Pink grey clay sand. Moderately compact. ~10% flint gravel.              |       |      |
| 1607   | Cut   |         | 1.8<br>5  | 0.54      | Ditch  |       |      |
| 1608   | Fill  | 1607    | 1.8<br>5  | 0.54      | Primary Fill. Mid pink grey clay sand. Moderately compact. Friable. ~10% flint gravel. |       |      |
| 1609   | Cut   |         | 0.4<br>1  | 0.09      | Ditch  |       |      |
| 1610   | Fill  | 1609    | 0.4<br>1  | 0.09      | Primary Fill. Mid pink grey clay sand. Moderately compact. Friable. ~20% Flint gravel. |       |      |
| <b>Trench 17</b>   |       |         |           |           |  |       |      |
| General description  |       |         |           |           | Orientation  | NE-SW |      |
| Trench revealed a series of excavated ditches, a tree throw and a pit. Five further ditches, four pits/postholes and two other features remain unexcavated. Trench consists of ploughsoil and subsoil overlying natural geology of clayey sand with gravels. |       |         |           |           | Length (m)   | 30    |      |
|  |       |         |           |           | Width (m)  | 2.1   |      |
|  |       |         |           |           | Avg. depth (m)   | 0.46  |      |
| Context No.  | Type  | Fill Of | Width (m) | Depth (m) | Description  | Finds | Date |
| 1700   | Layer |         |           | 0.32      | Ploughsoil. Mid brownish grey, clayey silt.  |       |      |
| 1701   | Layer |         |           | 0.14      | Subsoil. Mid grey brown, clayey sand.  |       |      |

|      |                     |      |          |      |   |  |  |
|------|---------------------|------|----------|------|---|--|--|
| 1702 | Layer               |      |          |      | Natural. Mid orangey brown, clayey sand with gravels.   |  |  |
| 1703 | Cut                 |      | 0.6<br>6 | 0.34 | Ditch. E-W alignment.   |  |  |
| 1704 | Fill                | 1703 | 0.6<br>6 | 0.34 | Secondary Fill. Mid brownish grey, clayey sand.   |  |  |
| 1705 | Unexcavated feature |      | 0.7      |      | Other Cut. Unknown type of feature, partly visible. Might be edge of curvilinear?   |  |  |
| 1706 | Unexcavated feature |      | 0.7<br>6 |      | Pit. possible pit, R.A.# 2 -fe object   |  |  |
| 1707 | Cut                 |      | 1.4      | 0.48 | Ditch. E-W alignment.   |  |  |
| 1708 | Fill                |      | 1.4      | 0.48 | Secondary Fill. Mid grey brown, clayey sand.  |  |  |
| 1709 | Layer               |      |          |      | Other Layer. Mid grey brown, clayey sand. Deposit possibly belonging to an earlier feature. Similar description to subsoil. |  |  |
| 1710 | Unexcavated feature |      | 1.1<br>5 |      | Ditch. Unexcavated feature. N-S alignment.  |  |  |
| 1711 | Unexcavated feature |      | 0.7<br>4 |      | Ditch. Possible terminus. Mid brownish grey, clayey sand.   |  |  |
| 1712 | Unexcavated feature |      | 0.3<br>3 |      | Posthole. Unexcavated feature   |  |  |
| 1713 | Unexcavated feature |      | 1.7<br>8 |      | Ditch. Linear, E-W alignment, Mid grey brown, clayey sand.  |  |  |
| 1714 | Unexcavated feature |      | 0.4<br>5 |      | Ditch. Unexcavated feature. N-S alignment, slightly curved to N-W-S-E   |  |  |
| 1715 | Unexcavated feature |      | 1.1<br>8 |      | Ditch. Historical boundary ditch, also in trs.23 & 30, Mid brownish grey, clayey sand.                                      |  |  |
| 1716 | Unexcavated feature |      | 1.1<br>2 |      | Other Cut. Possibly similar to [1718] & [1726]  |  |  |
| 1717 | Unexcavated feature |      | 0.4<br>1 |      | Posthole.   |  |  |
| 1718 | Cut                 |      | 0.8      | 0.44 | Ditch. Single fill, trunc. by [1726]  |  |  |
| 1719 | Fill                | 1718 | 0.8      | 0.44 | Secondary Fill. Mid yellow brown sandy silt   |  |  |
| 1720 | Cut                 |      | 0.8      | 0.44 | Ditch   |  |  |
| 1721 | Fill                | 1720 | 0.8      | 0.44 | Secondary Fill. Mid yellow brown sandy silt.  |  |  |
| 1722 | Cut                 |      | 0.3<br>9 | 0.18 | Tree Throw. Exc. as possible posthole   |  |  |
| 1723 | Fill                | 1722 | 0.3<br>9 | 0.18 | Other Fill. Mixed mid yellow brown and dark yellow brown silt.  |  |  |
| 1724 | Cut                 |      | 1.2<br>6 | 0.4  | Ditch. Single fill  |  |  |
| 1725 | Fill                | 1724 | 1.2<br>6 | 0.4  | Secondary Fill. Mid orange brown sandy silt.  |  |  |

|      |                     |      |      |      |  |  |  |
|------|---------------------|------|------|------|--|--|--|
| 1726 | Cut                 |      | 1.3  | 0.38 | Pit. Truncates [1718]  |  |  |
| 1727 | Fill                | 1726 | 1.3  | 0.38 | Deliberate Backfill. Dark yellow brown sandy silt with high frequency of charcoal. |  |  |
| 1728 | Unexcavated feature |      | 0.18 |      | Posthole.  |  |  |

### Trench 18

| General description   |       |         |           |           | Orientation                                | E-W   |      |
|---|-------|---------|-----------|-----------|--|-------|------|
| Trench devoid of archaeology. Consists of topsoil and subsoil over geology of gravel. |       |         |           |           | Length (m)                                 | 30    |      |
|   |       |         |           |           | Width (m)                                  | 2     |      |
|   |       |         |           |           | Avg. depth (m)                             | 0.45  |      |
| Context No.   | Type  | Fill Of | Width (m) | Depth (m) | Description                                | Finds | Date |
| 1800  | Layer |         |           | 0.35      | Ploughsoil. Dark brownish grey, sandy silt |       |      |
| 1801  | Layer |         |           | 0.1       | Subsoil. Yellowish brown sandy silt        |       |      |
| 1802  | Layer |         |           |           | Natural. Reddish yellow gravel.            |       |      |

### Trench 19

| General description  |       |         |           |           | Orientation  | N-S   |      |
|--|-------|---------|-----------|-----------|--|-------|------|
| Trench contains 2 ditches. Consists of ploughsoil overlying natural geology of clayey sand and gravel. |       |         |           |           | Length (m)   | 30    |      |
|  |       |         |           |           | Width (m)  | 2.1   |      |
|  |       |         |           |           | Avg. depth (m)   | 0.34  |      |
| Context No.  | Type  | Fill Of | Width (m) | Depth (m) | Description  | Finds | Date |
| 1900   | Layer |         |           | 0.33      | Ploughsoil. Dark grey brown, clayey silt                         |       |      |
| 1901   | Layer |         |           |           | Natural. Mid orange brown, clayey sand with gravel               |       |      |
| 1902   | Cut   |         | 0.88      | 0.41      | Ditch  |       |      |
| 1903   | Fill  | 1902    | 0.88      | 0.41      | Primary Fill. Mid brown grey, Silty clay, 2 pieces if slag found |       |      |
| 1904   | Cut   |         | 1.2       | 0.39      | Ditch  |       |      |
| 1905   | Fill  | 1904    | 1.2       | 0.39      | Primary Fill. Mid grey brown, Silty clay                         |       |      |

### Trench 20

|  |  |  |  |  |                |     |
|--|--|--|--|--|----------------|-----|
| General description  |  |  |  |  | Orientation    | N-S |
| Trench devoid of archaeology. Consists of ploughsoil and subsoil overlying natural geology of clayey sand with gravel patches. |  |  |  |  | Length (m)     | 30  |
|  |  |  |  |  | Width (m)      | 2.1 |
|  |  |  |  |  | Avg. depth (m) | 0.5 |

| Context No. | Type  | Fill Of | Width (m) | Depth (m) | Description  | Finds | Date |
|-------------|-------|---------|-----------|-----------|--|-------|------|
| 2000        | Layer |         |           | 0.33      | Ploughsoil. Dark grey brown, clayey silt                   |       |      |
| 2001        | Layer |         |           | 0.17      | Subsoil. Mid orange brown, clayey silt                     |       |      |
| 2002        | Layer |         |           |           | Natural. Mid brown orange, clayey sand with gravel patches |       |      |

### Trench 21

| General description  | Orientation    | E-W  |
|--|----------------|------|
| Trench devoid of archaeology. Consists of ploughsoil and subsoil overlying natural geology of clayey sand and gravel | Length (m)     | 30   |
|  | Width (m)      | 2.1  |
|  | Avg. depth (m) | 0.43 |

| Context No. | Type  | Fill Of | Width (m) | Depth (m) | Description  | Finds | Date |
|-------------|-------|---------|-----------|-----------|--|-------|------|
| 2100        | Layer |         |           | 0.33      | Ploughsoil. Dark grey brown, clayey sand           |       |      |
| 2101        | Layer |         |           | 0.09      | Subsoil. Mid orange brown, clayey sand             |       |      |
| 2102        | Layer |         |           |           | Natural. Mid brown orange, clayey sand with gravel |       |      |

### Trench 22

| General description   | Orientation    | E-W  |
|---|----------------|------|
| Trench devoid of archaeology. Consists of ploughsoil and subsoil overlying natural geology of sandy clay and gravel patches | Length (m)     | 30   |
|   | Width (m)      | 2.1  |
|   | Avg. depth (m) | 0.44 |

| Context No. | Type  | Fill Of | Width (m) | Depth (m) | Description   | Finds | Date |
|-------------|-------|---------|-----------|-----------|---|-------|------|
| 2200        | Layer |         |           | 0.33      | Ploughsoil. Dark grey brown, clayey silt                  |       |      |
| 2201        | Layer |         |           | 0.11      | Subsoil. Mid orange brown, silty clay                     |       |      |
| 2202        | Layer |         |           |           | Natural. Mid brown orange, sandy clay with gravel patches |       |      |

### Trench 23

| General description  | Orientation    | E-W  |
|--|----------------|------|
| Trench revealed two N-S linears; one ditch and one furrow. Consists of ploughsoil and subsoil overlying natural geology of clayey sand with gravels. | Length (m)     | 30   |
|  | Width (m)      | 2    |
|  | Avg. depth (m) | 0.43 |

| Context No. | Type | Fill Of | Width (m) | Depth (m) | Description | Finds | Date |
|-------------|------|---------|-----------|-----------|-------------|-------|------|
|-------------|------|---------|-----------|-----------|-------------|-------|------|

|      |       |      |          |      |   |  |  |
|------|-------|------|----------|------|---|--|--|
| 2300 | Layer |      |          | 0.4  | Ploughsoil. Dark brownish grey sandy clay           |  |  |
| 2301 | Layer |      |          | 0.15 | Subsoil. Mid greyish brown sandy clay               |  |  |
| 2302 | Cut   |      | 1.5      | 0.5  | Ditch   |  |  |
| 2303 | Fill  | 2302 | 1.5      | 0.5  | Secondary Fill. Mid - dark gryish brown clayey sand |  |  |
| 2304 | Cut   |      | 1.9<br>4 | 0.15 | Plough Furrow                                       |  |  |
| 2305 | Fill  | 2304 | 1.9<br>4 | 0.15 | Secondary Fill. Light greyish brown sandy clay.     |  |  |
| 2306 | Layer |      |          |      | Natural. Mid redish brown clayey sand with gravels  |  |  |

#### Trench 24

| General description  |       |         |           |           | Orientation   | N-S   |      |
|--|-------|---------|-----------|-----------|---|-------|------|
| Trench devoid of archaeology. Consist of ploughsoil overlying natural geology of clay gravel |       |         |           |           | Length (m)  | 30    |      |
|  |       |         |           |           | Width (m)   | 2.3   |      |
|  |       |         |           |           | Avg. depth (m)  | 0.39  |      |
| Context No.  | Type  | Fill Of | Width (m) | Depth (m) | Description   | Finds | Date |
| 2400   | Layer |         |           | 0.29      | Ploughsoil. Dark grey Clay with sand, with subrounded to wellrounded pebbles          |       |      |
| 2401   | Layer |         |           |           | Natural. Mid orange sandy clay with mid sorted gravel and mostly wellrounded fraction |       |      |

#### Trench 25

| General description  |       |         |           |           | Orientation   | N-S   |      |
|--|-------|---------|-----------|-----------|---|-------|------|
| Trench revealed one ditch. Consists of topsoil and subsoil overlying a natural geology of silty clay with streaks of gravel. |       |         |           |           | Length (m)  | 30    |      |
|  |       |         |           |           | Width (m)   | 2.2   |      |
|  |       |         |           |           | Avg. depth (m)  | 0.4   |      |
| Context No.  | Type  | Fill Of | Width (m) | Depth (m) | Description   | Finds | Date |
| 2500   | Layer |         |           | 0.29      | Ploughsoil. Mid grey brown silty clay                   |       |      |
| 2501   | Layer |         |           | 0.15      | Subsoil. Light-mid grey brown clay silt                 |       |      |
| 2502   | Layer |         |           |           | Natural. mid brown orange clay gravel                   |       |      |
| 2503   | Cut   |         | 1.9<br>6  | 0.52      | Ditch   |       |      |
| 2504   | Fill  | 2503    | 1.6<br>3  | 0.44      | Primary Fill. Mid- dark brown grey with charcoal flecks |       |      |
| 2505   | Fill  | 2503    | 1.9<br>6  | 0.52      | Secondary Fill. Light brown grey, silty clay            |       |      |

| 2506  | Fill  | 2503    | 0.9       | 0.14      | Tertiary Fill. layer of fired clay/burnt material              |       |      |
|---|-------|---------|-----------|-----------|--|-------|------|
| <b>Trench 26</b>  |       |         |           |           |  |       |      |
| General description   |       |         |           |           | Orientation  | E - W |      |
| Trench devoid of archaeology. Consists of plough soil and sub soil overlying a natural geology of clay gravel.                              |       |         |           |           | Length (m)   | 30    |      |
|   |       |         |           |           | Width (m)  | 2.2   |      |
|   |       |         |           |           | Avg. depth (m)   | 0.4   |      |
| Context No.   | Type  | Fill Of | Width (m) | Depth (m) | Description  | Finds | Date |
| 2600  | Layer |         |           | 0.32      | Ploughsoil. Dark grey brown silty clay                         |       |      |
| 2601  | Layer |         |           | 0.08      | Subsoil. Mid orange brown silty clay.                          |       |      |
| 2602  | Layer |         |           |           | Natural. Mid brown orange clay gravel                          |       |      |
| <b>Trench 27</b>  |       |         |           |           |  |       |      |
| General description   |       |         |           |           | Orientation  | N - S |      |
| Trench devoid of archaeology. Consist of ploughsoil and subsoil overlying natural geology of clay with sand and with some patches of gravel |       |         |           |           | Length (m)   | 30    |      |
|   |       |         |           |           | Width (m)  | 2.2   |      |
|   |       |         |           |           | Avg. depth (m)   | 0.45  |      |
| Context No.   | Type  | Fill Of | Width (m) | Depth (m) | Description  | Finds | Date |
| 2700  | Layer |         |           | 0.23      | Ploughsoil. Dark grey brown clay silt                          |       |      |
| 2701  | Layer |         |           | 0.15      | Subsoil. Mid orange brown sandy clay                           |       |      |
| 2702  | Layer |         |           |           | Natural. Mid orange clay sand gravel                           |       |      |
| 2703  | Cut   |         | 1.0<br>4  | 0.41      | Tree Throw. Irregular on plan, sides irregular and saymetrical |       |      |
| 2704  | Void  |         |           |           |  |       |      |
| <b>Trench 28</b>  |       |         |           |           |  |       |      |
| General description   |       |         |           |           | Orientation  | E-W   |      |
| Trench devoid of archaeology. Consists of ploughsoil and subsoil overlying natural geology of gravel with silty patches.                    |       |         |           |           | Length (m)   | 30    |      |
|   |       |         |           |           | Width (m)  | 2     |      |
|   |       |         |           |           | Avg. depth (m)   | 0.5   |      |
| Context No.   | Type  | Fill Of | Width (m) | Depth (m) | Description  | Finds | Date |
| 2800  | Layer |         |           | 0.3       | Ploughsoil. Dark brownish grey sandy silt                      |       |      |
| 2801  | Layer |         |           | 0.2       | Subsoil. Mid brownish grey sandy silt                          |       |      |

| 2802   | Layer |         |           |           | Natural. Reddish yellow gravel with silty patches                                    |       |      |
|--|-------|---------|-----------|-----------|--|-------|------|
| <b>Trench 29</b>   |       |         |           |           |  |       |      |
| General description  |       |         |           |           | Orientation  | N-S   |      |
| Trench devoid of archaeology. Consists of ploughsoil overlying a natural geology of clay and gravels.        |       |         |           |           | Length (m)   | 30    |      |
|  |       |         |           |           | Width (m)  | 2     |      |
|  |       |         |           |           | Avg. depth (m)   | 0.4   |      |
| Context No.  | Type  | Fill Of | Width (m) | Depth (m) | Description  | Finds | Date |
| 2900   | Layer |         |           | 0.4       | Ploughsoil. Mid greyish brown sandy silt.  |       |      |
| 2901   | Layer |         |           |           | Natural. Mid reddish brown clay gravel.  |       |      |
| 2902   | Cut   |         | 0.5<br>4  | 0.34      | Modern. Land drain.  |       |      |
| 2903   | Fill  | 2902    | 0.5<br>4  | 0.34      | Deliberate Backfill. Dark blackish grey sandy silt.                                  |       |      |
| <b>Trench 30</b>   |       |         |           |           |  |       |      |
| General description  |       |         |           |           | Orientation  | NE-SW |      |
| Trench containing one ditch. Consists of plough soil and subsoil overlying a natural geology of clay gravel. |       |         |           |           | Length (m)   | 30    |      |
|  |       |         |           |           | Width (m)  | 2     |      |
|  |       |         |           |           | Avg. depth (m)   | 0.5   |      |
| Context No.  | Type  | Fill Of | Width (m) | Depth (m) | Description  | Finds | Date |
| 3000   | Layer |         |           | 0.3       | Ploughsoil. Dark brownish grey sandy silt  |       |      |
| 3001   | Layer |         |           | 0.2       | Subsoil. Mid brownish grey, sandy silt   |       |      |
| 3002   | Layer |         |           |           | Natural. Reddish brown gravel and silty sand.  |       |      |
| 3003   | Cut   |         | 1.1<br>2  | 0.5       | Ditch  |       |      |
| 3004   | Fill  | 3003    | 0.6<br>6  | 0.08      | Primary Fill. Dark brownish grey sandy clay. Moderately loose. ~50% flint gravel.    |       |      |
| 3005   | Fill  | 3003    | 1.1<br>2  | 0.44      | Secondary Fill. Mid brownish grey sandy clay. Moderately compact. ~10% flint gravel. |       |      |
| <b>Trench 31</b>   |       |         |           |           |  |       |      |
| General description  |       |         |           |           | Orientation  | E-W   |      |
| Trench devoid of archaeology. Consists of ploughsoil and subsoil over geology of gravel with silty patches.  |       |         |           |           | Length (m)   | 30    |      |
|  |       |         |           |           | Width (m)  | 2     |      |
|  |       |         |           |           | Avg. depth (m)   | 0.5   |      |



| Context No. | Type  | Fill Of | Width (m) | Depth (m) | Description   | Finds | Date |
|-------------|-------|---------|-----------|-----------|---|-------|------|
| 3100        | Layer |         |           | 0.4       | Ploughsoil. Dark brownish grey sandy silt             |       |      |
| 3101        | Layer |         |           | 0.1       | Subsoil. Reddish brown sandy silt                     |       |      |
| 3102        | Layer |         |           |           | Natural. Reddish yellow gravel and silty sand patches |       |      |

### Trench 32

| General description  | Orientation    | N-S |
|--|----------------|-----|
| Trench revealed one linear and the edge of a possible pit. Ploughsoil and subsoil overlaying natural geology consisting of clayey sand with gravels. | Length (m)     | 30  |
|  | Width (m)      | 2.2 |
|  | Avg. depth (m) | 0.5 |

| Context No. | Type                | Fill Of | Width (m) | Depth (m) | Description   | Finds | Date |
|-------------|---------------------|---------|-----------|-----------|---|-------|------|
| 3200        | Layer               |         |           | 0.3       | Ploughsoil. Mid brownish grey, clayey sand            |       |      |
| 3201        | Layer               |         |           | 0.2       | Subsoil. Mid reddish brown clayey sand                |       |      |
| 3202        | Layer               |         |           |           | Natural. Mid orangey clayey sand with common gravel   |       |      |
| 3203        | Cut                 |         | 0.6       | 0.2       | Ditch. Linear, E-W, one fill (3204)                   |       |      |
| 3204        | Fill                | 3203    | 0.6       | 0.2       | Secondary Fill. Mid yellow brown clay sand            |       |      |
| 3205        | Unexcavated feature |         |           |           | Other Cut. Possible pit under east side of the trench |       |      |

### Trench 33

| General description  | Orientation    | N-S |
|--|----------------|-----|
| Trench devoid of archaeology. Consists of ploughsoil and subsoil over geology of gravel with sandy silt patches. | Length (m)     | 30  |
|  | Width (m)      | 24  |
|  | Avg. depth (m) | 0.6 |

| Context No. | Type  | Fill Of | Width (m) | Depth (m) | Description  | Finds | Date |
|-------------|-------|---------|-----------|-----------|--|-------|------|
| 3300        | Layer |         |           | 0.3       | Ploughsoil. Dark brownish grey sandy silt              |       |      |
| 3301        | Layer |         |           | 0.3       | Subsoil. Mid reddish brown sandy silt.                 |       |      |
| 3302        | Layer |         |           |           | Natural. Mid reddish yellow gravel with silty patches. |       |      |

### Trench 34

| General description | Orientation | E-W |
|---------------------|-------------|-----|
|                     | Length (m)  | 30  |

| Trench devoid of archaeology. Consists of ploughsoil and subsoil over geology of gravel with sandy silt patches                          |                     |         |           |           | Width (m)   | 2     |      |
|--|---------------------|---------|-----------|-----------|---|-------|------|
|  |                     |         |           |           | Avg. depth (m)  | 0.45  |      |
| Context No.  | Type                | Fill Of | Width (m) | Depth (m) | Description   | Finds | Date |
| 3400   | Layer               |         |           | 0.3       | Ploughsoil. Dark brownish grey sandy silt                                 |       |      |
| 3401   | Layer               |         |           | 0.15      | Subsoil. Mid reddish brown sandy silt                                     |       |      |
| 3402   | Layer               |         |           |           | Natural. Mid reddish brown gravel with yellowish grey silty sand patches. |       |      |
| <b>Trench 35</b>   |                     |         |           |           |   |       |      |
| General description  |                     |         |           |           | Orientation   | N-S   |      |
| Trench devoid of archaeology. Consisted of ploughsoil and subsoil overlying natural geology of sand and gravel.                          |                     |         |           |           | Length (m)  | 30    |      |
|  |                     |         |           |           | Width (m)   | 2     |      |
|  |                     |         |           |           | Avg. depth (m)  | 0.56  |      |
| Context No.  | Type                | Fill Of | Width (m) | Depth (m) | Description   | Finds | Date |
| 3500   | Layer               |         |           | 0.3       | Ploughsoil. Mid brown grey sand silt                                      |       |      |
| 3501   | Layer               |         |           | 0.14      | Subsoil. Dark red brown sand silt   |       |      |
| 3502   | Layer               |         |           |           | Natural. Mid red brown silt sand and gravel                               |       |      |
| <b>Trench 36</b>   |                     |         |           |           |   |       |      |
| General description  |                     |         |           |           | Orientation   | E-W   |      |
| Trench contains 8 linears, 5 pits and a posthole. Consists of ploughsoil and subsoil overlying natural geology of silty sand and gravel. |                     |         |           |           | Length (m)  | 30    |      |
|  |                     |         |           |           | Width (m)   | 2.1   |      |
|  |                     |         |           |           | Avg. depth (m)  | 0.43  |      |
| Context No.  | Type                | Fill Of | Width (m) | Depth (m) | Description   | Finds | Date |
| 3600   | Layer               |         |           | 0.5       | Ploughsoil. Dark grey brown, clayey sand                                  |       |      |
| 3601   | Layer               |         |           |           | Natural. Mid brown orange, silty sand with gravel patches                 |       |      |
| 3602   | Cut                 |         | 1.1<br>8  | 0.34      | Pit   |       |      |
| 3603   | Fill                | 3602    | 1.1<br>8  | 0.34      | Secondary Fill. Dark greyish brown, silty sand                            |       |      |
| 3604   | Unexcavated feature |         | 0.9       |           | Ditch. Light-mid greyish brown, silty sand                                |       |      |
| 3605   | Unexcavated feature |         | 0.7<br>4  |           | Pit. Mid greyish brown, silty sand  |       |      |
| 3606   | Unexcavated feature |         | 0.4<br>3  |           | Ditch. Light-mid greyish brown, silty sand                                |       |      |

|                     |                     |      |      |      |  |             |       |
|---------------------|---------------------|------|------|------|--|-------------|-------|
| 3607                | Unexcavated feature |      | 0.75 |      | Pit. Mid greyish brown, silty sand                 |             |       |
| 3608                | Unexcavated feature |      | 0.63 |      | Ditch. Mid greyish brown, silty sand               |             |       |
| 3609                | Fill                | 3613 | 0.85 | 0.27 | Secondary Fill. Mid greyish brown, silty sand      |             |       |
| 3610                | Fill                | 3618 | 0.79 | 0.09 | Secondary Fill. Dark grownish grey, silty sand     |             |       |
| 3611                | Fill                | 3618 | 1.04 | 0.3  | Secondary Fill. Dark brownish grey, silty sand     |             |       |
| 3612                | Fill                | 3617 | 1    | 0.04 | Other Fill. Mid orangey red, sandy clay            |             |       |
| 3613                | Cut                 |      | 0.85 | 0.27 | Pit  |             |       |
| 3614                | Cut                 |      | 0.4  | 0.2  | Ditch  |             |       |
| 3615                | Fill                | 3614 | 0.4  | 0.2  | Secondary Fill. Mid greyish brown, silty sand      |             |       |
| 3616                | Cut                 |      | 1.25 | 0.46 | Ditch  |             |       |
| 3617                | Cut                 |      | 2.2  | 0.48 | Ditch  |             |       |
| 3618                | Cut                 |      | 1.04 | 0.42 | Ditch  |             |       |
| 3619                | Cut                 |      | 0.28 | 0.36 | Posthole   |             |       |
| 3620                | Fill                | 3619 | 0.28 | 0.36 | Secondary Fill. Mid greyish brown, silty sand      |             |       |
| 3621                | Cut                 |      | 0.56 | 0.24 | Ditch  |             |       |
| 3622                | Fill                | 3621 | 0.56 | 0.24 | Secondary Fill. Mid-dark greyish brown, silty sand |             |       |
| 3623                | Unexcavated feature |      | 0.46 |      | Pit. Dark greyish brown, silty sand, charcoal rich |             |       |
| 3624                | Fill                | 3616 | 0.85 | 0.14 | Primary Fill. Light-mid greyish brown, silty sand  |             |       |
| 3625                | Fill                | 3616 | 1.25 | 0.42 | Secondary Fill. Mid-dark greyish brown, silty sand |             |       |
| 3626                | Fill                | 3617 | 2.2  | 0.12 | Primary Fill. Light-mid greyish brown, silty sand  |             |       |
| 3627                | Fill                | 3617 | 0.47 | 0.2  | Secondary Fill. Mid greyish brown, silty sand      |             |       |
| 3628                | Fill                | 3617 | 1    | 0.3  | Secondary Fill. Mid greyish brown, silty sand      |             |       |
| 3629                | Fill                | 3617 | 0.41 | 0.15 | Secondary Fill. Mid greyish brown, silty sand      |             |       |
| 3630                | Fill                | 3618 | 0.8  | 0.06 | Secondary Fill. Mid greyish brown, silty sand      |             |       |
| <b>Trench 37</b>    |                     |      |      |      |  |             |       |
| General description |                     |      |      |      |  | Orientation | NE-SW |
|                     |                     |      |      |      |  | Length (m)  | 15.2  |

| Trench revealed four ditches and three pits. Three of the ditches were left unexcavated. Possible pit alignment tested but found to be natural. Consists of ploughsoil and subsoil overlying natural geology of clayey sand and gravel |                     |         |           |           | Width (m)   | 15.2  |      |
|--|---------------------|---------|-----------|-----------|---|-------|------|
|  |                     |         |           |           | Avg. depth (m)  | 0.4   |      |
| Context No.  | Type                | Fill Of | Width (m) | Depth (m) | Description   | Finds | Date |
| 3700   | Layer               |         |           | 0.3       | Ploughsoil. Dark grey brown, clayey sand  |       |      |
| 3701   | Layer               |         |           | 0.1       | Subsoil. Mid orange brown, clayey sand  |       |      |
| 3702   | Layer               |         |           |           | Natural. Mid brown orange, clayey sand with gravel patches                              |       |      |
| 3703   | Unexcavated feature |         |           |           | Natural Feature. R.A. 13, iron object   |       |      |
| 3704   | Cut                 |         |           |           | Pit. S facing section   |       |      |
| 3705   | Cut                 |         | 0.4<br>6  | 0.16      | Ditch   |       |      |
| 3706   | Fill                | 3705    | 0.4<br>6  | 0.16      | Secondary Fill. Mid Greyish Brown, Sandy Silt, Moderate Gravel                          |       |      |
| 3707   | Cut                 |         | 0.9<br>2  | 0.28      | Pit. Suboval, sides rounded concave-symmetrical, Base flat                              |       |      |
| 3708   | Fill                | 3707    | 0.9<br>2  | 0.28      | Deliberate Backfill. Mid greyish brown Silty sand Friable                               |       |      |
| 3709   | Cut                 |         |           |           | Pit. Cut of unexcavated feature   |       |      |
| 3710   | Layer               |         |           |           | Other Layer. Light yellow brown, clay, evidence of some burning at Eastern side.        |       |      |
| 3711   | Layer               |         | 1.1       | 0.28      | Other Layer. light yellow brown, clay.  |       |      |
| 3712   | Layer               |         | 0.6       | 0.2       | Other Layer. mid yellow brown clay, with burnt red clay and dark brown burnt material . |       |      |
| 3713   | Fill                | 3709    |           |           | Secondary Fill. dark brown grey, unexcavated  |       |      |
| 3714   | Unexcavated feature |         |           |           | Ditch. Mid greyish brown  |       |      |
| 3715   | Unexcavated feature |         |           |           | Ditch. Mid greyish brown  |       |      |
| 3716   | Unexcavated feature |         |           |           | Ditch. Mid greyish brown  |       |      |
| 3717   | Unexcavated feature |         |           |           | Pit. Mid greyish brown  |       |      |
| 3718   | Cut                 |         | 0.8       | 0.22      | Pit   |       |      |
| 3719   | Fill                | 3718    | 0.8       | 0.22      | Secondary Fill. mid greyish brown, clayey silt, rare gravel                             |       |      |
| 3720   | Layer               |         |           |           | Natural. Investigated natural clay that appeared like a pit alignment from crop marks.  |       |      |

| Trench 38   |                     |         |           |           |  |       |      |
|---|---------------------|---------|-----------|-----------|--|-------|------|
| General description   |                     |         |           |           | Orientation  | NW-SE |      |
| Trench revealed seven pits, five ditches and two postholes.<br>Consisted of ploughsoil and subsoil overlying natural geology. |                     |         |           |           | Length (m)   | 30    |      |
|   |                     |         |           |           | Width (m)  | 2     |      |
|   |                     |         |           |           | Avg. depth (m)   | 0.59  |      |
| Context No.   | Type                | Fill Of | Width (m) | Depth (m) | Description  | Finds | Date |
| 3800  | Layer               |         |           | 0.32      | Ploughsoil. dark brown, silty sand                           |       |      |
| 3801  | Layer               |         |           | 0.25      | Subsoil. mid orange brown, silty sand                        |       |      |
| 3802  | Layer               |         |           |           | Natural. mid orange brown, silty sand with patches of gravel |       |      |
| 3803  | Cut                 |         | 1.1<br>6  | 0.29      | Pit  |       |      |
| 3804  | Fill                | 3803    | 1.1<br>6  | 0.29      | Secondary Fill. mid greyish brown, silty sand                |       |      |
| 3805  | Fill                | 3810    | 0.5<br>8  | 0.11      | Secondary Fill. light grey, silty sand                       |       |      |
| 3806  | Cut                 |         | 0.8<br>1  | 0.14      | Pit  |       |      |
| 3807  | Fill                | 3806    | 0.8<br>1  | 0.14      | Primary Fill. mid orange brown, silty sand                   |       |      |
| 3808  | Cut                 |         | 0.7<br>4  | 0.28      | Ditch  |       |      |
| 3809  | Fill                | 3808    | 0.7<br>4  | 0.28      | Primary Fill. mid grey brown, silty sand                     |       |      |
| 3810  | Cut                 |         | 0.5<br>8  | 0.45      | Pit  |       |      |
| 3811  | Unexcavated feature |         | 0.6<br>1  |           | Ditch. Dark grey brown, silty sand                           |       |      |
| 3812  | Unexcavated feature |         | 1.8<br>5  |           | Pit. Mid grey brown, silty sand                              |       |      |
| 3813  | Unexcavated feature |         | 0.9<br>5  |           | Pit. Mid orange brown, silty sand                            |       |      |
| 3814  | Unexcavated feature |         | 0.8<br>2  |           | Pit. Mid orange brown, silty sand                            |       |      |
| 3815  | Unexcavated feature |         | 0.3       |           | Posthole. Mid grey brown, silty sand                         |       |      |
| 3816  | Unexcavated feature |         | 0.3<br>9  |           | Posthole. Mid grey brown, silty sand                         |       |      |
| 3817  | Unexcavated feature |         | 0.8<br>1  |           | Ditch. Mid grey brown, silty sand                            |       |      |
| 3818  | Unexcavated feature |         | 1.4<br>5  |           | Ditch. Mid grey brow, silty sand                             |       |      |
| 3819  | Unexcavated feature |         | 2.1<br>5  |           | Ditch. Mid orange brown, silty sand                          |       |      |
| 3820  | Unexcavated feature |         | 0.4<br>8  |           | Pit. Mid grey, clayey sand                                   |       |      |

| Trench 39  |       |         |           |           |   |       |      |
|--|-------|---------|-----------|-----------|---|-------|------|
| General description  |       |         |           |           | Orientation   | N-S   |      |
| Trench revealed four ditches and two postholes. Consisted of ploughsoil and subsoil overlying natural geology. |       |         |           |           | Length (m)  | 30    |      |
|  |       |         |           |           | Width (m)   | 2     |      |
|  |       |         |           |           | Avg. depth (m)  | 0.45  |      |
| Context No.  | Type  | Fill Of | Width (m) | Depth (m) | Description   | Finds | Date |
| 3900   | Layer |         |           | 0.31      | Ploughsoil. Mid brown grey sand silt  |       |      |
| 3901   | Layer |         |           | 0.12      | Subsoil. Mid red brown sand silt  |       |      |
| 3902   | Layer |         |           |           | Natural. Mid yellow brown sand and gravel                                   |       |      |
| 3903   | Layer |         |           | 0.34      | Ploughsoil. Mid brown grey sand silt  |       |      |
| 3904   | Layer |         |           | 0.27      | Subsoil. Mid red brown sand silt  |       |      |
| 3905   | Layer |         |           |           | Natural. Mid yellow brown sand silt and gravel.                             |       |      |
| 3906   | Cut   |         | 0.38      | 0.1       | Posthole. Circular on plan, sides concave symmetrical, base rounded concave |       |      |
| 3907   | Fill  | 3906    | 0.38      | 0.1       | Primary Fill. Mid greyish brown, sandy clay                                 |       |      |
| 3908   | Cut   |         | 0.43      | 0.21      | Posthole. Circular on plan, sides rounded symmetrical, base- pointed        |       |      |
| 3909   | Fill  | 3908    | 0.43      | 0.21      | Primary Fill. Mid greyish brown, sandy clay                                 |       |      |
| 3910   | Cut   |         | 0.49      | 0.18      | Ditch. Linear, base rounded-concave   |       |      |
| 3911   | Fill  | 3910    | 0.49      | 0.18      | Deliberate Backfill. Light greyish brown, Clayey silt, Friable              |       |      |
| 3912   | Cut   |         | 0.72      | 0.21      | Ditch. Linear, Base flatish,  |       |      |
| 3913   | Fill  | 3912    | 0.72      | 0.21      | Deliberate Backfill   |       |      |
| 3914   | Cut   |         | 0.72      | 0.38      | Ditch. Linear, base pointed V-shape, sides straight symmetrical             |       |      |
| 3915   | Fill  | 3914    | 0.72      | 0.38      | Deliberate Backfill. Light brownish grey, Sandy clay with sand              |       |      |
| 3916   | Cut   |         | 0.84      | 0.44      | Ditch. Linear, Side rounded convex  |       |      |
| 3917   | Fill  | 3916    | 0.24      | 0.98      | Deliberate Backfill. Dark grey Silty sand Friable                           |       |      |
| 3918   | Fill  | 3916    | 0.84      | 0.28      | Deliberate Backfill. Mid brownish grey Sandy Silt Friable                   |       |      |
| Trench 40  |       |         |           |           |   |       |      |
| General description  |       |         |           |           | Orientation   | NW-SE |      |

| Trench contains four excavated ditches, as well as one unexcavated pit and one unexcavated post hole. Consist of topsoil and subsoil overlaing natural geology of coarse sand with gravel |                     |         |           |           | Length (m)   | 30    |      |
|---|---------------------|---------|-----------|-----------|--|-------|------|
|   |                     |         |           |           | Width (m)  | 2.3   |      |
|   |                     |         |           |           | Avg. depth (m)   | 0.48  |      |
| Context No.   | Type                | Fill Of | Width (m) | Depth (m) | Description  | Finds | Date |
| 4000  | Layer               |         |           | 0.29      | Ploughsoil. Dark grey sandy clay with gravel fraction is poor sorted |       |      |
| 4001  | Layer               |         |           | 0.1       | Subsoil. Mid greyish brown sandy clay with gravel                    |       |      |
| 4002  | Layer               |         |           |           | Natural. Mid orange sand with gravel                                 |       |      |
| 4003  | Cut                 |         | 1.2<br>9  | 0.32      | Ditch  |       |      |
| 4004  | Fill                | 4003    | 1.2<br>9  | 0.32      | Secondary Fill. Mid brown, silty clay with gravel patches            |       |      |
| 4005  | Fill                | 4006    | 0.9<br>4  | 0.35      | Secondary Fill. Mid orange brown, silty clay with frequent gravel    |       |      |
| 4006  | Cut                 |         | 0.9<br>4  | 0.35      | Ditch  |       |      |
| 4007  | Fill                | 4008    | 1.1       | 0.41      | Secondary Fill. Mid orange brown, silty clay                         |       |      |
| 4008  | Cut                 |         | 1.1       | 0.41      | Ditch  |       |      |
| 4009  | Fill                | 4010    | 0.4<br>3  | 0.06      | Secondary Fill. Dark orange brown, silty sand                        |       |      |
| 4010  | Cut                 |         | 0.4<br>3  | 0.06      | Ditch  |       |      |
| 4011  | Cut                 |         | 1.4<br>5  | 0.35      | Natural Feature  |       |      |
| 4012  | Fill                | 4011    | 1.4<br>5  | 0.35      | Other Fill. Natural patch. Mid grey, silty sand.                     |       |      |
| 4013  | Unexcavated feature |         | 0.8<br>6  |           | Pit. Mid grey brown, silty sand                                      |       |      |
| 4014  | Unexcavated feature |         | 0.3<br>5  |           | Posthole. Light grey, silty sand                                     |       |      |
| 4015  | Unexcavated feature |         |           |           | Ditch. Extends beyond LOE. Ditch present on crop marks.              |       |      |
| <b>Trench 41</b>  |                     |         |           |           |  |       |      |
| General description   |                     |         |           |           | Orientation  | E-W   |      |
| Trench devoid of archaeology. Consist of ploughsoil overlying natural geology of coarse sand with gravel  |                     |         |           |           | Length (m)   | 30    |      |
|   |                     |         |           |           | Width (m)  | 2.3   |      |
|   |                     |         |           |           | Avg. depth (m)   | 0.4   |      |
| Context No.   | Type                | Fill Of | Width (m) | Depth (m) | Description  | Finds | Date |
| 4100  | Layer               |         | 2.3       | 0.29      | Ploughsoil. Dark grey sandy clay with well rounded pebbles           |       |      |

| 4101  | Layer               |         | 2.3       | 0.08      | Natural. Mid orange clayey sand and coarse sand with gravel. Fraction is mid sorted with wellrounded pebbles |       |      |
|---|---------------------|---------|-----------|-----------|--|-------|------|
| <b>Trench 42</b>  |                     |         |           |           |  |       |      |
| General description   |                     |         |           |           | Orientation  | NW-SE |      |
| Trench revealed four ditches, a gully and two pits. Two ditches, the gully and one pit were left unexcavated and recorded in plan only. Consist of ploughsoil overlying natural geology of coarse sand with gravel. |                     |         |           |           | Length (m)   | 30    |      |
|   |                     |         |           |           | Width (m)  | 2     |      |
|   |                     |         |           |           | Avg. depth (m)   | 0.43  |      |
| Context No.   | Type                | Fill Of | Width (m) | Depth (m) | Description  | Finds | Date |
| 4200  | Layer               |         | 2.3       | 0.32      | Ploughsoil   |       |      |
| 4201  | Layer               |         | 2.3       | 0.09      | Natural  |       |      |
| 4202  | Cut                 |         | 5.4<br>2  | 0.83      | Ditch  |       |      |
| 4203  | Fill                | 4202    | 4.3<br>8  | 0.83      | Secondary Fill. Dark grey, sandy silt.   |       |      |
| 4204  | Cut                 |         | 0.8<br>3  | 0.46      | Ditch  |       |      |
| 4205  | Fill                | 4204    | 0.8<br>3  | 0.46      | Secondary Fill. Dark grey, sandy silt.   |       |      |
| 4206  | Cut                 |         | 0.6       | 0.3       | Pit  |       |      |
| 4207  | Fill                | 4206    | 0.6       | 0.3       | Secondary Fill. Dark grey, sandy silt.   |       |      |
| 4208  | Fill                | 4202    | 1.3<br>2  | 0.72      | Secondary Fill. Dark brownish grey, sandy silt.  |       |      |
| 4209  | Unexcavated feature |         |           |           | Ditch. Dark grey, sandy silt. Possible land drain.   |       |      |
| 4210  | Unexcavated feature |         |           | 1.45      | Ditch. Dark brownish grey, sandy silt.   |       |      |
| 4211  | Unexcavated feature |         |           |           | Ditch. Dark brownish grey, sandy silt.   |       |      |
| 4212  | Unexcavated feature |         |           |           | Pit. Dark brownish grey, sandy silt.   |       |      |
| <b>Trench 43</b>  |                     |         |           |           |  |       |      |
| General description   |                     |         |           |           | Orientation  | E-W   |      |
| Trench contains two ditches, one pit and big structure in the West part of the trench. Consist of ploughsoil and subsoil overlying natural geology of coarse sand with gravel                                       |                     |         |           |           | Length (m)   | 30    |      |
|   |                     |         |           |           | Width (m)  | 2.3   |      |
|   |                     |         |           |           | Avg. depth (m)   | 0.42  |      |
| Context No.   | Type                | Fill Of | Width (m) | Depth (m) | Description  | Finds | Date |
| 4300  | Layer               |         | 30        | 0.29      | Ploughsoil. Dark grey clay with sand   |       |      |



|  |                     |         |           |           |   |       |      |
|--|---------------------|---------|-----------|-----------|---|-------|------|
| 4301   | Layer               |         | 2.3       | 0.12      | Subsoil. Mid greyish brown sandy clay, with rounded to well rounded pebbels |       |      |
| 4302   | Layer               |         | 2.3       | 0.07      | Natural. Mid orange coarse sand with subrounded to wellrounded gravel       |       |      |
| 4303   | Layer               |         |           | 0.06      | Other Layer. mid grey, sandy silt   |       |      |
| 4304   | Cut                 |         | 3.2<br>4  | 0.5       | Ditch   |       |      |
| 4305   | Fill                | 4304    | 1.2<br>8  | 0.5       | Primary Fill. Mid grey brown. Sandy silt                                    |       |      |
| 4306   | Fill                | 4304    | 0.9<br>5  | 0.5       | Secondary Fill. Dark grey brown. Sandy silt.                                |       |      |
| 4307   | Fill                | 4304    | 2.4<br>3  | 0.5       | Tertiary Fill. Light grey brown. Sandy silt.                                |       |      |
| 4308   | Cut                 |         | 2.1<br>8  | 0.44      | Ditch   |       |      |
| 4309   | Fill                | 4308    | 1.8       | 0.44      | Secondary Fill. Mid grey brown. Sandy silt.                                 |       |      |
| 4310   | Fill                | 4308    | 2.1<br>8  | 0.24      | Tertiary Fill. Light grey brown. Sandy silt.                                |       |      |
| 4311   | Cut                 |         | 0.6<br>6  | 0.22      | Ditch   |       |      |
| 4312   | Fill                | 4311    | 0.6<br>6  | 0.22      | Primary Fill. Mid grey brown sandy silt                                     |       |      |
| 4313   | Cut                 |         | 0.8       | 0.24      | Ditch   |       |      |
| 4314   | Fill                | 4313    | 0.8       | 0.24      | Primary Fill. Mid grey sandy silt.  |       |      |
| 4315   | Unexcavated feature |         | 1.0<br>6  |           | Ditch. Dark grey brown. Sandy silt.   |       |      |
| 4316   | Unexcavated feature |         | 0.6<br>4  |           | Ditch. Mid yellow brown. Sandy silt.  |       |      |
| 4317   | Fill                | 4304    | 0.2<br>7  | 0.46      | Primary Fill. Drag orange brown. Silty sand (80-90% gravel inclusions).     |       |      |
| 4318   | Unexcavated feature |         | 1.0<br>9  |           | Ditch. Mid grey brown. Silty sand.  |       |      |
| 4319   | Unexcavated feature |         | 1.1<br>1  |           | Ditch. Mid grey. Silty sand.  |       |      |
| <b>Trench 44</b>   |                     |         |           |           |   |       |      |
| General description  |                     |         |           |           | Orientation   | W-E   |      |
| Trench contains four ditches including one terminus, posthole and pit. Consist of ploughsoil and subsoil overlying a natural geology of sand with gravel |                     |         |           |           | Length (m)  | 30    |      |
|  |                     |         |           |           | Width (m)   | 2.3   |      |
|  |                     |         |           |           | Avg. depth (m)  | 0.48  |      |
| Context No.  | Type                | Fill Of | Width (m) | Depth (m) | Description   | Finds | Date |
| 4400   | Layer               |         | 2.3       | 0.32      | Ploughsoil. Dark greish brown Clay sand with gravel                         |       |      |

|      |                     |      |          |      |  |  |  |
|------|---------------------|------|----------|------|--|--|--|
| 4401 | Layer               |      | 2.3      | 30   | Natural. Mid orange gravel with coarse sand  |  |  |
| 4402 | Fill                | 4403 | 1.1<br>6 | 0.3  | Primary Fill. Mid greyish brown, sandy silt. R.A. 11, iron object. Pottery and bone present. |  |  |
| 4403 | Cut                 |      | 1.1<br>6 | 0.3  | Ditch  |  |  |
| 4404 | Cut                 |      | 0.7<br>4 | 0.28 | Ditch  |  |  |
| 4405 | Fill                | 4404 | 0.7<br>4 | 0.28 | Primary Fill. Mid brown, sandy silt. Pot and CBM present.                                    |  |  |
| 4406 | Cut                 |      | 1.3      | 0.46 | Ditch  |  |  |
| 4407 | Fill                | 4406 | 1.3      | 0.46 | Primary Fill. Mid greyish brown, sandy silt. Pottery present.                                |  |  |
| 4408 | Cut                 |      | 0.5      | 0.32 | Posthole   |  |  |
| 4409 | Fill                | 4408 | 0.5      | 0.32 | Primary Fill. Mid greyish brown, sandy silt. Pottery present.                                |  |  |
| 4410 | Cut                 |      | 0.6<br>2 | 0.12 | Pit  |  |  |
| 4411 | Fill                | 4410 | 0.6<br>2 | 0.12 | Primary Fill. Mid greyish brown, sandy silt. No finds.                                       |  |  |
| 4412 | Unexcavated feature |      | 0.6<br>2 |      | Ditch  |  |  |
| 4413 | Unexcavated feature |      | 0.6<br>6 |      | Ditch  |  |  |
| 4414 | Unexcavated feature |      | 0.4      |      | Ditch  |  |  |
| 4415 | Unexcavated feature |      | 0.8<br>6 |      | Pit  |  |  |

#### Trench 45

| General description   |       |         |           |           | Orientation  | E - W |      |
|---|-------|---------|-----------|-----------|--|-------|------|
| Trench revealed two ditches, two postholes, two possible pits and a discrete feature (not excavated) Consisted of ploughsoil and subsoil overlying natural geology. |       |         |           |           | Length (m)   | 30    |      |
|   |       |         |           |           | Width (m)  | 2.2   |      |
|   |       |         |           |           | Avg. depth (m)   | 0.4   |      |
| Context No.   | Type  | Fill Of | Width (m) | Depth (m) | Description  | Finds | Date |
| 4500  | Layer |         |           | 0.3       | Ploughsoil. Dark brown silty sand                        |       |      |
| 4501  | Layer |         |           | 0.2       | Subsoil. Mid greyish brown silty sand                    |       |      |
| 4502  | Layer |         |           |           | Natural. Mid orangey clayey sand and coarse gravel       |       |      |
| 4503  | Cut   |         | 2.8       | 0.5       | Ring Ditch. Recut by [4507]. Base not fully excavated    |       |      |
| 4504  | Fill  | 4503    | 1.4<br>4  | 0.5       | Secondary Fill. Mid brown clayey sand , fine gravel. Top |       |      |

|      |                     |      |          |      |   |  |  |
|------|---------------------|------|----------|------|---|--|--|
| 4505 | Fill                | 4503 | 2.2      |      | Secondary Fill. Mid greyish brown clayey sand and fine gravel - middle              |  |  |
| 4506 | Fill                | 4503 | 2.8      | 0.5  | Primary Fill. Light greyish brown clayey sand and coarse gravel - low (primary)     |  |  |
| 4507 | Cut                 |      | 0.7      | 0.1  | Ditch. Recut in the central part of ring ditch [4503]                               |  |  |
| 4508 | Fill                | 4507 | 0.7      | 0.1  | Secondary Fill. Dark brown clayey silt with charcoal fragments                      |  |  |
| 4509 | Cut                 |      | 0.3<br>6 | 0.18 | Posthole. Central part of the trench (western posthole)                             |  |  |
| 4510 | Fill                | 4509 | 0.3<br>6 | 0.18 | Deliberate Backfill. Mid greyish brown clayey sand. No finds                        |  |  |
| 4511 | Cut                 |      | 0.4<br>4 | 0.14 | Posthole. Central part of the trench. Eastern one                                   |  |  |
| 4512 | Fill                | 4511 | 0.4<br>4 | 0.14 | Deliberate Backfill. Mid greyish brown clayey sand. No finds                        |  |  |
| 4513 | Cut                 |      | 1.3      | 0.4  | Ditch. Linear that runs N-S in the western part of trench. Cut by land drain [4515] |  |  |
| 4514 | Fill                | 4513 | 1.3      | 0.36 | Secondary Fill. Mid greyish brown clayey sand with sparse coarse gravel             |  |  |
| 4515 | Cut                 |      |          |      | Modern. Land drain  |  |  |
| 4516 | Unexcavated feature |      |          |      | Pit. Possible pit laying under the southern side of the trench in its western party |  |  |
| 4517 | Unexcavated feature |      |          |      | Pit. Possible pit in the western part of the trench                                 |  |  |
| 4518 | Fill                | 4513 | 0.6      | 0.05 | Primary Fill. Light greyish brown, clayey sand with gravel                          |  |  |
| 4519 | Unexcavated feature |      |          |      | Other Cut. Feature at the West end of trench. Pot on surface                        |  |  |

#### Trench 46

|  |                |         |
|--|----------------|---------|
| General description  | Orientation    | NNW-SSE |
| Trench revealed two possible ditches and 5 post holes.<br>Consisted of ploughsoil and subsoil overlying natural geology. | Length (m)     | 30      |
|  | Width (m)      | 2       |
|  | Avg. depth (m) | 0.38    |

| Context No. | Type  | Fill Of | Width (m) | Depth (m) | Description  | Finds | Date |
|-------------|-------|---------|-----------|-----------|--|-------|------|
| 4600        | Layer |         |           | 0.23      | Ploughsoil. Dark greyish brown clayey silt.        |       |      |
| 4601        | Layer |         |           |           | Natural. Mid reddish brown sandy clay and gravels. |       |      |
| 4602        | Cut   |         | 0.4<br>6  | 0.09      | Posthole   |       |      |

|   |                     |      |          |      |  |                |       |
|---|---------------------|------|----------|------|--|----------------|-------|
| 4603  | Fill                | 4602 | 0.4<br>6 | 0.09 | Deliberate Backfill. Mid greyish brown sandy silt.                           |                |       |
| 4604  | Cut                 |      | 0.4<br>6 | 0.34 | Posthole   |                |       |
| 4605  | Fill                | 4604 | 0.4<br>6 | 0.34 | Deliberate Backfill. Mid greyish brown sandy silt.                           |                |       |
| 4606  | Cut                 |      | 1.8<br>6 | 0.56 | Ditch. Truncated by land drain 4610.   |                |       |
| 4607  | Fill                | 4606 | 1.8<br>4 | 0.56 | Primary Fill. Small find number 4 (Cu pin?). Light greyish brown sandy silt. |                |       |
| 4608  | Fill                | 4615 | 1.1      | 0.45 | Primary Fill. R.A. 9 & 10  |                |       |
| 4609  | Fill                | 4606 | 1.1<br>9 | 0.44 | Secondary Fill. Mid greyish brown clayey silt.                               |                |       |
| 4610  | Cut                 |      | 0.2<br>6 |      | Modern. Land drain. Truncates ditch 4606.                                    |                |       |
| 4611  | Fill                | 4610 | 0.2<br>6 |      | Deliberate Backfill. Dark greyish brown sandy silt.                          |                |       |
| 4612  | Layer               |      |          | 0.09 | Subsoil. Light greyish brown sandy silt.                                     |                |       |
| 4613  | Cut                 |      | 0.3<br>8 | 0.14 | Posthole   |                |       |
| 4614  | Fill                | 4613 | 0.3<br>8 | 0.14 | Deliberate Backfill. Mid greyish brown sandy silt.                           |                |       |
| 4615  | Cut                 |      |          |      | Ditch  |                |       |
| 4616  | Unexcavated feature |      |          |      | Posthole. Dark grey brown sandy silt fill                                    |                |       |
| 4617  | Unexcavated feature |      |          |      | Posthole. Dark grey brown sandy silt fill                                    |                |       |
| 4618  | Unexcavated feature |      |          |      | Posthole. Dark grey brown sandy silt fill                                    |                |       |
| 4619  | Unexcavated feature |      |          |      | Posthole. Dark grey brown sandy silt fill                                    |                |       |
| 4620  | Unexcavated feature |      |          |      | Posthole. Dark grey brown sandy silt fill                                    |                |       |
| 4621  | Unexcavated feature |      |          |      | Posthole. Dark grey brown sandy silt fill                                    |                |       |
| 4622  | Unexcavated feature |      |          |      | Posthole. Dark grey brown sandy silty fill                                   |                |       |
| 4623  | Unexcavated feature |      |          |      | Posthole. Dark grey brown sandy silty fill                                   |                |       |
| 4624  | Cut                 |      | 1.1      | 0.38 | Ditch. Re-cut of 4606  |                |       |
| 4625  | Cut                 |      |          |      | void   |                |       |
| <b>Trench 47</b>  |                     |      |          |      |  |                |       |
| General description   |                     |      |          |      |  | Orientation    | E - W |
| Trench revealed 3 ditches. Consists of ploughsoil and subsoil overlying the natural geology of Sandy gravel |                     |      |          |      |  | Length (m)     | 30    |
|   |                     |      |          |      |  | Width (m)      | 2.2   |
|   |                     |      |          |      |  | Avg. depth (m) | 0.45  |

| Context No.   | Type  | Fill Of | Width (m) | Depth (m) | Description   | Finds | Date |
|---|-------|---------|-----------|-----------|---|-------|------|
| 4700  | Layer |         |           | 0.33      | Ploughsoil. Dark brownish grey, soft, clayey sand with gravel.  |       |      |
| 4701  | Layer |         |           | 0.05      | Subsoil. Dark brown, soft clayey sand.  |       |      |
| 4702  | Layer |         |           |           | Natural. Orange-brown, friable gravel and soft coarse sand.   |       |      |
| 4703  | Cut   |         | 0.8<br>4  | 0.28      | Ditch. Cut by modern land drain.  |       |      |
| 4704  | Fill  | 4703    | 0.5<br>6  | 0.12      | Secondary Fill. Mid greyish brown, soft, silty, gravely sand.   |       |      |
| 4705  | Fill  | 4703    | 0.8<br>4  | 0.16      | Secondary Fill. Mid grey, soft silty, clayey sand.  |       |      |
| 4706  | Cut   |         | 0.9       | 0.52      | Ditch. Not fully excavated as its depth has reached the safety limit. Cut by [4712].  |       |      |
| 4707  | Fill  | 4706    | 0.2       | 0.16      | Secondary Fill. Mid-grey, soft, silty, clayey sand. The fill is not fully excavated. Dimensions given are the minimum values. |       |      |
| 4708  | Fill  | 4706    | 0.7       | 0.18      | Secondary Fill. Mid greyish brown, soft, silty sand.  |       |      |
| 4709  | Fill  | 4706    | 0.7<br>4  | 0.14      | Deliberate Backfill. Mid brownish grey, soft, silty, clayey sand. Contained pottery.  |       |      |
| 4710  | Fill  | 4706    | 0.9       | 0.12      | Deliberate Backfill. Or placed deposit? Moderately compact gravel with mid brownish grey silty sandy matrix between.          |       |      |
| 4711  | Fill  | 4706    | 0.9       | 0.26      | Secondary Fill. Grey, soft, silty, clayey sand.   |       |      |
| 4712  | Cut   |         | 0.9<br>8  | 0.56      | Ditch   |       |      |
| 4713  | Fill  | 4712    | 0.3       | 0.2       | Deliberate Backfill. Dark brown, soft, silty sand with gravel.  |       |      |
| 4714  | Fill  | 4712    | 0.9<br>8  | 0.36      | Deliberate Backfill. Mid brown, soft, silty, clayey sand. Contained pottery and clay pipe fragment.                           |       |      |
| 4715  | Cut   |         | 0.8<br>0  | 0.52      | Ditch. Re-cut of ditch 4706.  |       |      |
| <b>Trench 48</b>  |       |         |           |           |   |       |      |
| General description   |       |         |           |           | Orientation   | N - S |      |
| Trench contained one ditch. Consisted of ploughsoil and subsoil overlying natural geology of gravel and sand. |       |         |           |           | Length (m)  | 30    |      |
|   |       |         |           |           | Width (m)   | 2.2   |      |
|   |       |         |           |           | Avg. depth (m)  | 0.42  |      |

| Context No. | Type  | Fill Of | Width (m) | Depth (m) | Description  | Finds | Date |
|-------------|-------|---------|-----------|-----------|--|-------|------|
| 4800        | Layer |         |           |           | Ploughsoil   |       |      |
| 4801        | Layer |         |           |           | Subsoil  |       |      |
| 4802        | Layer |         |           |           | Natural  |       |      |
| 4803        | Cut   |         | 0.8       | 0.28      | Ditch  |       |      |
| 4804        | Fill  | 4803    | 0.8       | 0.28      | Secondary Fill. Mid Greyish Brown, Sandy Silt, Infrequent Gravel |       |      |

#### Trench 49

|   |                |       |
|---|----------------|-------|
| General description   | Orientation    | E - W |
| Trench contains 3 ditches. Consists of ploughsoil and subsoil overlying natural geology of gravel, sand and clay. | Length (m)     | 30    |
|   | Width (m)      | 2.2   |
|   | Avg. depth (m) | 0.45  |

| Context No. | Type  | Fill Of | Width (m) | Depth (m) | Description   | Finds | Date |
|-------------|-------|---------|-----------|-----------|---|-------|------|
| 4900        | Layer |         |           |           | Ploughsoil  |       |      |
| 4901        | Layer |         |           |           | Subsoil   |       |      |
| 4902        | Layer |         |           |           | Natural   |       |      |
| 4903        | Cut   |         | 1.2<br>6  | 0.44      | Ditch   |       |      |
| 4904        | Fill  | 4903    | 1.2<br>6  | 0.44      | Secondary Fill. Mid greyish brown Sandy Silt Infrequent gravel  |       |      |
| 4905        | Cut   |         | 0.4       | 0.14      | Ditch   |       |      |
| 4906        | Fill  | 4905    | 0.1<br>4  | 0.4       | Secondary Fill. Mid greyish brown Sandy Silt Infrequent gravel  |       |      |
| 4907        | Cut   |         | 1.4<br>2  | 0.42      | Ditch   |       |      |
| 4908        | Fill  |         | 1.4<br>2  | 0.42      | Secondary Fill. Mid Greyish Brown, Sandy Silt Infrequent Gravel |       |      |

#### Trench 50

|  |                |      |
|--|----------------|------|
| General description  | Orientation    | N-S  |
| Trench contained one ditch terminus. Consisted of ploughsoil and subsoil overlying natural geology of gravel, sand and clay. | Length (m)     | 30   |
|  | Width (m)      | 2    |
|  | Avg. depth (m) | 0.52 |

| Context No. | Type  | Fill Of | Width (m) | Depth (m) | Description                          | Finds | Date |
|-------------|-------|---------|-----------|-----------|--------------------------------------|-------|------|
| 5000        | Layer |         |           | 0.32      | Ploughsoil. Mid brown grey sand silt |       |      |
| 5001        | Layer |         |           | 0.12      | Subsoil. Mid red brown sand silt     |       |      |

| 5002  | Layer |         |           |           | Natural. Mid red brown silt sand and gravel                    |       |      |
|---|-------|---------|-----------|-----------|--|-------|------|
| 5003  | Cut   |         | 0.9<br>6  | 0.26      | Ditch  |       |      |
| 5004  | Fill  | 5003    | 0.9<br>6  | 0.26      | Secondary Fill. Mid greyish brown, sandy silt, moderate gravel |       |      |
| <b>Trench 51</b>  |       |         |           |           |  |       |      |
| General description   |       |         |           |           | Orientation  | E-W   |      |
| Trench devoid of archaeology. Consisted of ploughsoil and subsoil overlying natural geology.  |       |         |           |           | Length (m)   | 30    |      |
|   |       |         |           |           | Width (m)  | 2     |      |
|   |       |         |           |           | Avg. depth (m)   | 0.4   |      |
| Context No.   | Type  | Fill Of | Width (m) | Depth (m) | Description  | Finds | Date |
| 5100  | Layer |         |           | 0.3       | Ploughsoil. Mid brown grey sand silt                           |       |      |
| 5101  | Layer |         |           | 0.1       | Subsoil. Mid red brown sand silt                               |       |      |
| 5102  | Layer |         |           |           | Natural. Mid red brown silt sand and gravel.                   |       |      |
| <b>Trench 52</b>  |       |         |           |           |  |       |      |
| General description   |       |         |           |           | Orientation  | N-S   |      |
| Trench revealed one ditch. Field Drain present. Consisted of ploughsoil and subsoil overlying natural geology of gravel, sand and clay. |       |         |           |           | Length (m)   | 30    |      |
|   |       |         |           |           | Width (m)  | 2     |      |
|   |       |         |           |           | Avg. depth (m)   | 0.47  |      |
| Context No.   | Type  | Fill Of | Width (m) | Depth (m) | Description  | Finds | Date |
| 5200  | Layer |         |           | 0.4       | Ploughsoil. Mid brown grey sand silt                           |       |      |
| 5201  | Layer |         |           | 0.23      | Subsoil. Mid red brown sand silt                               |       |      |
| 5202  | Layer |         |           |           | Natural. Mid red brown silt sand and gravel                    |       |      |
| 5203  | Cut   |         | 0.6<br>4  | 0.14      | Ditch  |       |      |
| 5204  | Fill  | 5203    | 0.6<br>4  | 0.14      | Secondary Fill. mid greyish brown, sandy silt, moderate gravel |       |      |
| <b>Trench 53</b>  |       |         |           |           |  |       |      |
| General description   |       |         |           |           | Orientation  | N - S |      |
| Trench revealed one pit and three natural features. Consists of ploughsoil and subsoil overlying natural geology of clay gravel         |       |         |           |           | Length (m)   | 30    |      |
|   |       |         |           |           | Width (m)  | 20    |      |
|   |       |         |           |           | Avg. depth (m)   | 0.4   |      |

| Context No. | Type  | Fill Of | Width (m) | Depth (m) | Description  | Finds | Date |
|-------------|-------|---------|-----------|-----------|--|-------|------|
| 5300        | Layer |         |           | 0.35      | Ploughsoil. Dark greyish brown                                   |       |      |
| 5301        | Layer |         |           |           | Natural. Mid brown orangey                                       |       |      |
| 5302        | Cut   |         |           |           | Natural Feature. Possible treethrow                              |       |      |
| 5303        | Fill  | 5302    |           |           | Primary Fill   |       |      |
| 5304        | Cut   |         | 1.2<br>6  | 0.28      | Pit  |       |      |
| 5305        | Fill  | 5304    | 1.2<br>6  | 0.28      | Secondary Fill. Dark orange brown, silty sand                    |       |      |
| 5306        | Cut   |         | 3.6       | 0.44      | Natural Feature. Not completely excavated due to excessive depth |       |      |
| 5307        | Fill  | 5306    |           |           | Secondary Fill. mid orangey brown silty clay compact             |       |      |
| 5308        | Cut   |         | 2         | 0.5       | Natural Feature  |       |      |
| 5309        | Fill  | 5308    | 2         | 0.5       | Secondary Fill. mid greyish brown, sandy silt                    |       |      |
| 5310        | Fill  | 5308    | 1.4       | 0.2       | Secondary Fill. mid to dark brownish grey, sandy silt            |       |      |

#### Trench 54

|  |                |     |
|--|----------------|-----|
| General description  | Orientation    | E-W |
| Trench devoid of archaeology. Consists of ploughsoil and subsoil overlying a natural geology of clay gravel. | Length (m)     | 30  |
|  | Width (m)      | 2   |
|  | Avg. depth (m) | 0.5 |

| Context No. | Type  | Fill Of | Width (m) | Depth (m) | Description                                 | Finds | Date |
|-------------|-------|---------|-----------|-----------|---|-------|------|
| 5400        | Layer |         |           | 0.3       | Ploughsoil. Mid brown grey sand silt        |       |      |
| 5401        | Layer |         |           | 0.2       | Subsoil. Mid red brown sand silt            |       |      |
| 5402        | Layer |         |           |           | Natural. Mid red brown silt sand and gravel |       |      |

#### Trench 55

|  |                |      |
|--|----------------|------|
| General description  | Orientation    | N-S  |
| Trench revealed one tree throw. Excavated, no finds. Consisted of ploughsoil and subsoil overlying natural geology of gravel and sand. | Length (m)     | 40   |
|  | Width (m)      | 2    |
|  | Avg. depth (m) | 0.48 |

| Context No. | Type  | Fill Of | Width (m) | Depth (m) | Description                          | Finds | Date |
|-------------|-------|---------|-----------|-----------|--------------------------------------|-------|------|
| 5500        | Layer |         |           | 0.3       | Ploughsoil. Mid brown grey sand silt |       |      |
| 5501        | Layer |         |           | 0.18      | Subsoil. Mid red brown sand silt     |       |      |



|      |       |      |          |      |  |  |  |
|------|-------|------|----------|------|--|--|--|
| 5502 | Layer |      |          |      | Natural. Mid red brown silt sand and gravel      |  |  |
| 5503 | Cut   |      | 2.3<br>4 | 0.34 | Tree Throw                                       |  |  |
| 5504 | Fill  | 5503 | 2.3<br>4 | 0.34 | Secondary Fill. Light Greyish Brown, Sandy Silt. |  |  |

### Trench 56

|  |  |  |  |  |                |     |
|--|--|--|--|--|----------------|-----|
| General description  |  |  |  |  | Orientation    | E-W |
| Trench revealed three ditches. Consisted of ploughsoil and subsoil overlying natural geology of gravel, sand and clay. |  |  |  |  | Length (m)     | 30  |
|  |  |  |  |  | Width (m)      | 2   |
|  |  |  |  |  | Avg. depth (m) | 0.5 |

| Context No. | Type  | Fill Of | Width (m) | Depth (m) | Description  | Finds | Date |
|-------------|-------|---------|-----------|-----------|--|-------|------|
| 5600        | Layer |         |           | 0.3       | Ploughsoil. Mid brown grey sand silt                         |       |      |
| 5601        | Layer |         |           | 0.2       | Subsoil. Mid red brown sand silt                             |       |      |
| 5602        | Layer |         |           |           | Natural. Mid red brown sand silt and gravel                  |       |      |
| 5603        | Cut   |         | 1.2<br>6  | 0.36      | Ditch  |       |      |
| 5604        | Fill  | 5603    | 1.2<br>6  | 0.36      | Secondary Fill. Mid greyish brown, Sandy Silt                |       |      |
| 5605        | Cut   |         | 0.5<br>4  | 0.18      | Ditch  |       |      |
| 5606        | Fill  | 5605    | 0.5<br>4  | 0.18      | Secondary Fill. Mid greyish brown, Sandy silt                |       |      |
| 5607        | Cut   |         | 1.5<br>8  | 0.46      | Ditch  |       |      |
| 5608        | Fill  | 5607    | 0.4       | 0.16      | Primary Fill. Mid greyish brown, Sandy silt, Frequent Gravel |       |      |
| 5609        | Fill  | 5607    | 1.5<br>8  | 0.46      | Secondary Fill. Mid greyish brown, Sandy Silt                |       |      |

### Trench 57

|  |  |  |  |  |                |       |
|--|--|--|--|--|----------------|-------|
| General description  |  |  |  |  | Orientation    | N - S |
| Trench devoid of archaeology. Consist of plough soil and subsoil overlying a natural geology of clay sand gravel |  |  |  |  | Length (m)     | 30    |
|  |  |  |  |  | Width (m)      | 2.2   |
|  |  |  |  |  | Avg. depth (m) | 0.45  |

| Context No. | Type  | Fill Of | Width (m) | Depth (m) | Description                                 | Finds | Date |
|-------------|-------|---------|-----------|-----------|---|-------|------|
| 5700        | Layer |         |           | 0.3       | Ploughsoil. Dark grey brown silty clay      |       |      |
| 5701        | Layer |         |           | 0.15      | Subsoil. mid orange brown silty clay        |       |      |
| 5702        | Layer |         |           |           | Natural. Mid brown orange clay sand gravel. |       |      |

| <b>Trench 58</b>   |       |         |           |           |  |         |      |
|--|-------|---------|-----------|-----------|--|---------|------|
| General description  |       |         |           |           | Orientation  | NE - SW |      |
| Trench devoid of archaeology. Consists of plough soil and sub soil overlying a natural geology of clay gravel. |       |         |           |           | Length (m)   | 30      |      |
|  |       |         |           |           | Width (m)  | 2.2     |      |
|  |       |         |           |           | Avg. depth (m)   | 0.45    |      |
| Context No.  | Type  | Fill Of | Width (m) | Depth (m) | Description  | Finds   | Date |
| 5800   | Layer |         |           | 0.3       | Ploughsoil. Dark grey brown silty clay.                            |         |      |
| 5801   | Layer |         |           | 0.15      | Subsoil. Mid orange brown silty clay.                              |         |      |
| 5802   | Layer |         |           |           | Natural. Mid brown orange clay gravel.                             |         |      |
| <b>Trench 59</b>   |       |         |           |           |  |         |      |
| General description  |       |         |           |           | Orientation  | N - S   |      |
| Trench devoid of archaeology. Consists of plough soil and sub soil overlying a natural geology of clay gravel. |       |         |           |           | Length (m)   | 30      |      |
|  |       |         |           |           | Width (m)  | 2.2     |      |
|  |       |         |           |           | Avg. depth (m)   | 0.5     |      |
| Context No.  | Type  | Fill Of | Width (m) | Depth (m) | Description  | Finds   | Date |
| 5900   | Layer |         |           | 0.3       | Ploughsoil. Dark grey brown silty clay.                            |         |      |
| 5901   | Layer |         |           | 0.2       | Subsoil. Mid orange brown silty clay.                              |         |      |
| 5902   | Layer |         |           |           | Natural. Mid brown orange clay gravel.                             |         |      |
| <b>Trench 60</b>   |       |         |           |           |  |         |      |
| General description  |       |         |           |           | Orientation  | E - W   |      |
| Trench revealed two ditches. Consists of ploughsoil and subsoil overlying natural geology of clay gravel       |       |         |           |           | Length (m)   | 30      |      |
|  |       |         |           |           | Width (m)  | 2.2     |      |
|  |       |         |           |           | Avg. depth (m)   | 0.45    |      |
| Context No.  | Type  | Fill Of | Width (m) | Depth (m) | Description  | Finds   | Date |
| 6000   | Layer |         |           | 0.25      | Ploughsoil. Dark orange grey silty clay. Very rare angular gravels |         |      |
| 6001   | Layer |         |           |           | Natural. Mixed brownish orange sand and rounded geavels            |         |      |
| 6002   | Layer |         |           | 0.1       | Subsoil. Light greyish orange silty clay, no inclusions            |         |      |
| 6003   | Cut   |         | 1.2       | 0.47      | Ditch  |         |      |
| 6004   | Fill  | 6003    | 0.5       | 0.08      | Primary Fill   |         |      |

|      |      |      |          |      |   |  |  |
|------|------|------|----------|------|---|--|--|
| 6005 | Fill | 6003 | 0.6<br>2 | 0.06 | Primary Fill                                |  |  |
| 6006 | Fill |      | 0.4<br>2 | 0.28 | Secondary Fill                              |  |  |
| 6007 | Fill |      | 1.0<br>2 | 0.3  | Secondary Fill                              |  |  |
| 6008 | Cut  |      |          |      | Ditch                                       |  |  |
| 6009 | Fill | 6008 |          |      | Primary Fill                                |  |  |
| 6010 | Fill | 6008 |          |      | Secondary Fill                              |  |  |
| 6011 | Fill | 6008 | 0.1      | 0.04 | Other Fill. Light greyish black, silty sand |  |  |

### Trench 61

| General description   |       |         |           |           | Orientation   | N - S |      |
|---|-------|---------|-----------|-----------|---|-------|------|
| Trench traveled two natural features. Consists of ploughsoil and subsoil overlying natural geology of clayey gravel |       |         |           |           | Length (m)  | 30    |      |
|   |       |         |           |           | Width (m)   | 4.4   |      |
|   |       |         |           |           | Avg. depth (m)  | 0.45  |      |
| Context No.   | Type  | Fill Of | Width (m) | Depth (m) | Description   | Finds | Date |
| 6100  | Layer |         |           | 0.3       | Ploughsoil. Dark brownish grey, clayey sand                           |       |      |
| 6101  | Layer |         |           | 0.09      | Subsoil. Light-mid greyish brown, silty sand                          |       |      |
| 6102  | Layer |         |           |           | Natural. Light-mid yellowish and reddish brown sandy clay and gravels |       |      |
| 6103  | Cut   |         | 1.2       | 0.06      | Natural Feature   |       |      |
| 6104  | Fill  | 6103    | 1.2       | 0.06      | Secondary Fill. Light greyish brown, clayey sand                      |       |      |
| 6105  | Cut   |         | 0.7<br>2  | 0.14      | Hedgerow  |       |      |
| 6106  | Fill  | 6105    | 0.7<br>2  | 0.14      | Secondary Fill. Light-mid greyish brown, silty sand                   |       |      |

### Trench 62

| General description |       |         |           |           | Orientation                             | N - S |      |
|---------------------|-------|---------|-----------|-----------|---|-------|------|
|                     |       |         |           |           | Length (m)                              | 30    |      |
|                     |       |         |           |           | Width (m)                               | 2.2   |      |
|                     |       |         |           |           | Avg. depth (m)                          | 0.46  |      |
| Context No.         | Type  | Fill Of | Width (m) | Depth (m) | Description                             | Finds | Date |
| 6200                | Layer |         |           | 0.3       | Ploughsoil. Dark grey brown silty clay. |       |      |
| 6201                | Layer |         |           | 0.16      | Subsoil. Mid orange brown silty clay.   |       |      |

|      |       |      |     |     |   |  |  |
|------|-------|------|-----|-----|---|--|--|
| 6202 | Layer |      |     |     | Natural. Mid brown orange clay gravel.  |  |  |
| 6203 | Cut   |      | 1.4 | 0.5 | Ditch. S - part of the trench, runs E - W. Base not fully excavated (1m from the topsoil reached). RA 12 + mid iron age to Roman pot fragments in the fill (6204) |  |  |
| 6204 | Fill  | 6203 | 1.4 | 0.5 | Secondary Fill. RA 12   |  |  |

### Trench 63

|   |  |                |       |
|---|--|----------------|-------|
| General description   |  | Orientation    | N - S |
| Trench revealed only 2 post holes and as a result both were excavated. This ended up showed that only one was real, the other being a natural feature. Consists of ploughsoil and subsoil overlying a natural geology of clay gravel. |  | Length (m)     | 30    |
|   |  | Width (m)      | 2.2   |
|   |  | Avg. depth (m) | 0.45  |

| Context No. | Type  | Fill Of | Width (m) | Depth (m) | Description   | Finds | Date |
|-------------|-------|---------|-----------|-----------|---|-------|------|
| 6300        | Layer |         |           | 0.23      | Ploughsoil. Dark greyish brown, clayey sand   |       |      |
| 6301        | Layer |         |           | 0.1       | Subsoil. Mid grey brown, clayey sand  |       |      |
| 6302        | Layer |         |           |           | Natural. Mid orangey brown, clayey sand with gravels  |       |      |
| 6303        | Cut   |         | 0.3       | 0.25      | Posthole. Fragments of coarse pot, iron age?  |       |      |
| 6304        | Fill  | 6303    | 0.3       | 0.25      | Deliberate Backfill. Mid greyish brown clayey sand. Coarse pot fragments                                  |       |      |
| 6305        | Cut   |         | 0.4       | 0.1       | Natural Feature. 1/2 excavated. No finds  |       |      |
| 6306        | Fill  | 6305    | 0.4       | 0.1       | Secondary Fill. Investigated because on the same line of [6303]. only fill of a natural feature. No finds |       |      |

### Trench 64

|   |  |                |       |
|---|--|----------------|-------|
| General description   |  | Orientation    | E - W |
| Trench revealed a ditch terminus, one tree throw and one pit. Excavated, no finds. Consisted of ploughsoil and subsoil overlying natural geology. |  | Length (m)     | 30    |
|   |  | Width (m)      | 2.2   |
|   |  | Avg. depth (m) | 0.6   |

| Context No. | Type  | Fill Of | Width (m) | Depth (m) | Description                               | Finds | Date |
|-------------|-------|---------|-----------|-----------|---|-------|------|
| 6400        | Layer |         |           | 0.3       | Ploughsoil. Dark greyish brown sandy clay |       |      |
| 6401        | Layer |         |           | 0.3       | Subsoil. Mid reddish brown sandy clay     |       |      |

|      |       |      |          |      |  |  |  |
|------|-------|------|----------|------|--|--|--|
| 6402 | Layer |      |          |      | Natural. Mid reddish brown clayey sand with gravel   |  |  |
| 6403 | Cut   |      | 0.7      | 0.27 | Ditch. Possible terminus, NW - SE  |  |  |
| 6404 | Fill  | 6403 | 0.7      | 0.27 | Secondary Fill. Light reddish gray silty sand  |  |  |
| 6405 | Cut   |      | 0.4      | 0.11 | Pit. West. Possible residual   |  |  |
| 6406 | Fill  | 6405 |          |      | Secondary Fill. Mid greyish brown clayey sand.no finds   |  |  |
| 6407 | Cut   |      | 0.6<br>8 | 0.07 | Natural Feature. In the E- part of the trench there are two subrounded features. This is the Eastern one |  |  |
| 6408 | Fill  | 6407 | 0.6<br>8 | 0.07 | Secondary Fill. Mid greyish brown silty sand, no finds   |  |  |
| 6409 | Cut   |      | 2.2<br>5 | 0.22 | Tree Throw. Suboval, irregular, no finds   |  |  |
| 6410 | Fill  | 6409 | 2.2<br>5 | 0.22 | Secondary Fill. Mid greyish brown clayey sand, no finds  |  |  |

### Trench 65

| General description  |       |         |           |           | Orientation                             | N - S |      |
|--|-------|---------|-----------|-----------|---|-------|------|
| Trench devoid of archaeology. Consists of plough soil and sub soil overlying a natural geology of clay gravel. |       |         |           |           | Length (m)                              | 30    |      |
|  |       |         |           |           | Width (m)                               | 2.2   |      |
|  |       |         |           |           | Avg. depth (m)                          | 0.58  |      |
| Context No.  | Type  | Fill Of | Width (m) | Depth (m) | Description                             | Finds | Date |
| 6500   | Layer |         |           | 0.33      | Ploughsoil. Dark grey brown silty clay. |       |      |
| 6501   | Layer |         |           | 0.25      | Subsoil. Mid orange brown silty clay.   |       |      |
| 6502   | Layer |         |           |           | Natural. Mid brown orange clay gravel.  |       |      |

### Trench 66

| General description  |       |         |           |           | Orientation   | E-W   |      |
|--|-------|---------|-----------|-----------|---|-------|------|
| Consists of ploughsoil and sub soil overlying a natural geology of clay and gravels. Unurned cremation at eastern end. |       |         |           |           | Length (m)  | 30    |      |
|  |       |         |           |           | Width (m)   | 2.2   |      |
|  |       |         |           |           | Avg. depth (m)  | 0.5   |      |
| Context No.  | Type  | Fill Of | Width (m) | Depth (m) | Description   | Finds | Date |
| 6600   | Layer |         |           | 0.29      | Ploughsoil. Mid brown sandy silt.                         |       |      |
| 6601   | Layer |         |           | 0.19      | Subsoil. Mid reddish brown silty clay.                    |       |      |
| 6602   | Layer |         |           |           | Natural. Mid reddish brown silty clay gravel.             |       |      |
| 6603   | Group |         |           |           | Cremation Cut. Consists of cremation cut 6604, fill 6605. |       |      |

|      |       |      |          |      |   |  |  |
|------|-------|------|----------|------|---|--|--|
|      |       |      |          |      | Material surrounding cut given number 6606. Three samples taken numbers (1), (2), (3). Photogrametry job 1 and 2. |  |  |
| 6604 | Cut   |      | 0.3<br>1 | 0.12 | Cremation Cut. Part of group 6603   |  |  |
| 6605 | Fill  | 6604 | 0.3<br>1 | 0.12 | Cremation Deposit. Mid blackish grey silt. Sample numbers 1 and 2.  |  |  |
| 6606 | Layer |      | 0.1      | 0.17 | Natural. Material surrounding cremation cut 6604. Mid reddish brown silty clay. Sample number 3.                  |  |  |

### Trench 67

| General description  |       |         |           |           | Orientation                             | N - S |      |
|--|-------|---------|-----------|-----------|---|-------|------|
| Trench devoid of archaeology. Consists of plough soil and sub soil overlying a natural geology of clay gravel. |       |         |           |           | Length (m)                              | 30    |      |
|  |       |         |           |           | Width (m)                               | 2.2   |      |
|  |       |         |           |           | Avg. depth (m)                          | 0.55  |      |
| Context No.  | Type  | Fill Of | Width (m) | Depth (m) | Description                             | Finds | Date |
| 6700   | Layer |         |           | 0.3       | Ploughsoil. Dark grey brown silty clay. |       |      |
| 6701   | Layer |         |           | 0.25      | Subsoil. Mid orange brown silty clay.   |       |      |
| 6702   | Layer |         |           |           | Natural. Mid brown orange clay gravel.  |       |      |

### Trench 68

| General description  |       |         |           |           | Orientation                                 | N-S   |      |
|--|-------|---------|-----------|-----------|---|-------|------|
| Trench devoid of archaeology. Consisted of ploughsoil and subsoil overlying natural geology. |       |         |           |           | Length (m)                                  | 30    |      |
|  |       |         |           |           | Width (m)                                   | 2     |      |
|  |       |         |           |           | Avg. depth (m)                              | 0.44  |      |
| Context No.  | Type  | Fill Of | Width (m) | Depth (m) | Description                                 | Finds | Date |
| 6800   | Layer |         |           | 0.3       | Ploughsoil. Mid brown grey sand silt        |       |      |
| 6801   | Layer |         |           | 0.14      | Subsoil. Dark red brown sand silt           |       |      |
| 6802   | Layer |         |           |           | Natural. Mid red brown sand silt and gravel |       |      |

### Trench 69

|  |  |  |  |  |                |      |
|--|--|--|--|--|----------------|------|
| General description  |  |  |  |  | Orientation    | N-S  |
| Trench revealed one ditch. Consisted of ploughsoil and subsoil overlying natural geology |  |  |  |  | Length (m)     | 30   |
|  |  |  |  |  | Width (m)      | 2    |
|  |  |  |  |  | Avg. depth (m) | 0.58 |

| Context No. | Type  | Fill Of | Width (m) | Depth (m) | Description                                   | Finds | Date |
|-------------|-------|---------|-----------|-----------|---|-------|------|
| 6900        | Layer |         |           | 0.3       | Ploughsoil. Mid brown grey sand silt          |       |      |
| 6901        | Layer |         |           | 0.3       | Subsoil. Dark red brown sand silt             |       |      |
| 6902        | Layer |         |           |           | Natural. Mid red brown silt sand and gravel   |       |      |
| 6903        | Cut   |         | 0.8<br>5  | 0.23      | Ditch   |       |      |
| 6904        | Fill  | 6903    | 0.6<br>4  | 0.08      | Secondary Fill. mid brown, silty sand         |       |      |
| 6905        | Fill  | 6903    | 0.8<br>5  | 0.14      | Secondary Fill. mid orange brown, clayey silt |       |      |

### Trench 70

| General description   | Orientation    | E-W  |
|---|----------------|------|
| Trench revealed three ditches alignment N-S. Consisted of ploughsoil and subsoil overlying natural geology. | Length (m)     | 30   |
|   | Width (m)      | 2    |
|   | Avg. depth (m) | 0.62 |

| Context No. | Type                | Fill Of | Width (m) | Depth (m) | Description                                  | Finds | Date |
|-------------|---------------------|---------|-----------|-----------|--|-------|------|
| 7000        | Layer               |         |           | 0.31      | Ploughsoil. Mid brown grey sand silt         |       |      |
| 7001        | Layer               |         |           | 0.32      | Subsoil. Dark red brown sand silt            |       |      |
| 7002        | Layer               |         |           |           | Natural. Mid red brown sand silt and gravel  |       |      |
| 7003        | Cut                 |         | 1.4<br>1  | 0.19      | Ditch  |       |      |
| 7004        | Fill                | 7003    | 1.4<br>1  | 0.19      | Secondary Fill. Mid orange brown, silty clay |       |      |
| 7005        | Unexcavated feature |         | 1.4       |           | Ditch  |       |      |
| 7006        | Unexcavated feature |         | 0.7       |           | Ditch  |       |      |

### Trench 71

| General description   | Orientation    | N-S |
|---|----------------|-----|
| Trench devoid of archaeology. Consists of ploughsoil and subsoil overlying natural geology of clay. | Length (m)     | 30  |
|   | Width (m)      | 2   |
|   | Avg. depth (m) | 0.5 |

| Context No. | Type  | Fill Of | Width (m) | Depth (m) | Description                                 | Finds | Date |
|-------------|-------|---------|-----------|-----------|---|-------|------|
| 7100        | Layer |         |           | 0.3       | Ploughsoil. Mid brownish grey, clayey sand. |       |      |
| 7101        | Layer |         |           | 0.2       | Subsoil. Mid greyish brown, clayey sand.    |       |      |

|      |       |      |     |      |   |  |  |
|------|-------|------|-----|------|---|--|--|
| 7102 | Layer |      |     |      | Natural. Mid orangey brown, clayey sand with gravels. |  |  |
| 7103 | Cut   |      | 0.7 | 0.13 | Tree Throw  |  |  |
| 7104 | Fill  | 7103 | 0.7 | 0.13 | Primary Fill. Light greyish brown, sandy silt.        |  |  |

### Trench 72

|  |                |     |
|--|----------------|-----|
| General description  | Orientation    | N-S |
| Trench revealed one tree throw which has been investigated. Consists of plough soil and subsoil overlying a natural geology of clay and gravels. | Length (m)     | 30  |
|  | Width (m)      | 2   |
|  | Avg. depth (m) | 0.5 |

| Context No. | Type  | Fill Of | Width (m) | Depth (m) | Description   | Finds | Date |
|-------------|-------|---------|-----------|-----------|---|-------|------|
| 7200        | Layer |         |           | 0.3       | Ploughsoil. Mid brownish grey, clayey sand.           |       |      |
| 7201        | Layer |         |           | 0.2       | Subsoil. Mid grey brown, clayey sand.                 |       |      |
| 7202        | Layer |         |           |           | Natural. Mid orangey brown, clayey sand with gravels. |       |      |
| 7203        | Cut   |         | 2.4       | 0.28      | Tree Throw  |       |      |
| 7204        | Fill  | 7203    | 1.5<br>8  | 0.28      | Primary Fill. Light brown sandy silt.                 |       |      |

### Trench 73

|   |                |     |
|---|----------------|-----|
| General description   | Orientation    | W-E |
| Trench revealed two natural features. Consists of ploughsoil and subsoil overlying a natural geology of clay sand gravel. | Length (m)     | 30  |
|   | Width (m)      | 2   |
|   | Avg. depth (m) | 0.5 |

| Context No. | Type  | Fill Of | Width (m) | Depth (m) | Description   | Finds | Date |
|-------------|-------|---------|-----------|-----------|---|-------|------|
| 7300        | Layer |         |           | 0.3       | Ploughsoil. Mid brownish grey, clayey sand.                                     |       |      |
| 7301        | Layer |         |           | 0.2       | Subsoil. Mid grey brown, clayey sand.   |       |      |
| 7302        | Layer |         |           |           | Natural. Mid orangey brown, clayey sand with gravels.                           |       |      |
| 7303        | Cut   |         | 0.5<br>6  | 0.14      | Natural Feature. Irregular, follows a shift in the geology. No rooting activity |       |      |
| 7304        | Fill  | 7303    | 0.5<br>6  | 0.14      | Secondary Fill. Light yellowish grey Silty sand, no finds                       |       |      |

### Trench 74

|  |             |     |
|--|-------------|-----|
| General description  | Orientation | N-S |
| Trench devoid of archaeology. Ploughsoil and subsoil overlying natural geology consisting of clayey sand with gravels. | Length (m)  | 30  |
|  | Width (m)   | 2   |



|  |       |         |           |           |  | Avg. depth (m) | 0.5   |  |
|--|-------|---------|-----------|-----------|--|----------------|-------|--|
| Context No.  | Type  | Fill Of | Width (m) | Depth (m) | Description  | Finds          | Date  |  |
| 7400   | Layer |         |           | 0.3       | Ploughsoil. Mid brownish grey, clayey sand.  |                |       |  |
| 7401   | Layer |         |           | 0.2       | Subsoil. Mid grey brown, clayey sand.  |                |       |  |
| 7402   | Layer |         |           |           | Natural. Mid orangey brown, clayey sand with gravels.                                    |                |       |  |
| <b>Trench 75</b>   |       |         |           |           |  |                |       |  |
| General description  |       |         |           |           |  | Orientation    | N - S |  |
| Trench revealed 3 linear features and 1 curilinear feature. 1 terminus which could be the end of one of 2 ditches, unknown as the relationship is under the bulk |       |         |           |           |  | Length (m)     | 30    |  |
|  |       |         |           |           |  | Width (m)      | 2.2   |  |
|  |       |         |           |           |  | Avg. depth (m) |       |  |
| Context No.  | Type  | Fill Of | Width (m) | Depth (m) | Description  | Finds          | Date  |  |
| 7500   | Layer |         |           | 0.28      | Ploughsoil. Dark greyish brown silty sand with sparse gravel                             |                |       |  |
| 7501   | Layer |         |           | 0.22      | Subsoil. Mid greyish brown clayey sand with sparse coarse gravel                         |                |       |  |
| 7502   | Layer |         |           |           | Natural. Mid orangey clayey sand with gravel   |                |       |  |
| 7503   | Cut   |         | 0.3<br>8  | 0.2       | Posthole. North part of trench   |                |       |  |
| 7504   | Fill  | 7503    | 0.3<br>8  | 0.2       | Deliberate Backfill. Mid greyish brown clayey sand. Fragment of pot                      |                |       |  |
| 7505   | Cut   |         | 0.6<br>4  | 0.34      | Ditch. NW - SE   |                |       |  |
| 7506   | Fill  | 7505    | 0.4       | 0.26      | Secondary Fill. Mid greyish brown clayey sand with sparse pebbles                        |                |       |  |
| 7507   | Fill  | 7505    |           | 0.06      | Primary Fill. Mid greyish brown clayey sand with no inclusions                           |                |       |  |
| 7508   | Cut   |         |           |           | Ditch. South end   |                |       |  |
| 7509   | Fill  | 7508    |           |           | Secondary Fill   |                |       |  |
| 7510   | Cut   |         |           |           | Ditch. Cut by both ditches 7512 and 7514   |                |       |  |
| 7511   | Fill  | 7510    | 0.7       | 0.16      | Deliberate Backfill. Mid grey brown, clayey silt, 5% rounded gravel inclusions, no finds |                |       |  |
| 7512   | Cut   |         | 0.8       | 0.48      | Ditch. Cut by ditch 7514 and cuts ditch 7510   |                |       |  |
| 7513   | Fill  | 7512    | 0.8       | 0.48      | Deliberate Backfill. Mid grey brown, clayey silt, 10% gravel inclusions, no finds        |                |       |  |

| 7514   | Cut                 |         | 2.4<br>2  | 0.38      | Ditch. Cuts ditches 7510 and 7512   |       |      |
|--|---------------------|---------|-----------|-----------|---|-------|------|
| 7515   | Fill                | 7514    | 2.4<br>2  | 0.38      | Deliberate Backfill. Mid grey brown, clayey silt, friable, 2%> gravel, finds of flint and pottery |       |      |
| <b>Trench 76</b>   |                     |         |           |           |   |       |      |
| General description  |                     |         |           |           | Orientation   | N - S |      |
| Trench revealed 2 ditches and a gully. Consists of ploughsoil and subsoil overlying natural geology of clayey gravel |                     |         |           |           | Length (m)  | 30    |      |
|  |                     |         |           |           | Width (m)   | 2.2   |      |
|  |                     |         |           |           | Avg. depth (m)  | 0.5   |      |
| Context No.  | Type                | Fill Of | Width (m) | Depth (m) | Description   | Finds | Date |
| 7600   | Layer               |         |           | 0.37      | Ploughsoil. Mid grey brown silty soil, loose.   |       |      |
| 7601   | Layer               |         |           | 0.16      | Subsoil. Mid orange brown silty clay, friable.  |       |      |
| 7602   | Layer               |         |           |           | Natural. Mid orange brown silty clay, friable. Gravel, loose.                                     |       |      |
| 7603   | Cut                 |         | 0.3<br>4  | 0.14      | Ditch   |       |      |
| 7604   | Fill                | 7603    | 0.3<br>5  | 0.14      | Secondary Fill. Mid grey brown silty clay, loose, gravel inclusions.                              |       |      |
| 7605   | Cut                 |         | 2.7<br>4  | 0.58      | Ditch   |       |      |
| 7606   | Fill                | 7605    | 1.3<br>2  | 0.26      | Deliberate Backfill. Dark grey brown silty clay, loose, gravel inclusions.                        |       |      |
| 7607   | Fill                | 7605    | 2.5       | 0.58      | Secondary Fill. Mid orange brown silty clay, friable.   |       |      |
| 7608   | Unexcavated feature |         | 1.1       |           | Ditch. Mid grey brown, silty clay, loose. Ditch terminus.   |       |      |

### B.1 Prehistoric Pottery

By Alex Davies

#### Introduction

- B.1.1 Some 289 sherds (3193g) of prehistoric pottery were recovered from 28 contexts across 14 trenches (Table 1). All the material could be accommodated within the date range c 1150-50 cal BC, covering the late Bronze Age to middle Iron Age. At least three sequential periods were represented by diagnostic material: the late Bronze Age/earliest Iron Age (c 1000-600 cal BC), early Iron Age (c 600-350 cal BC) and middle Iron Age (c 350-50 cal BC). While no certain late Bronze Age material was found and all of the pottery could date to the Iron Age, similarities in fabrics and some forms between the late Bronze Age and Iron Age means that spot-dating based on limited material and little contextual information is often quite broad and many date ranges include the late Bronze Age.
- B.1.2 The mean sherd weight (MSW) of 11g is reasonably high for later prehistoric assemblages, and indicates the pottery is well-preserved.
- B.1.3 This section does not consider late Iron Age material. This pottery is dealt with alongside the Roman material, below.

#### Fabrics

- B.1.4 Flint was the dominant fabric, followed by quartz sand and a vesicular fabric likely to have originally contained shell. A limited number of sherds contained glauconitic sand.
- B.1.5 Fabrics can be compared with nearby later prehistoric assemblages at Mucking (Barrett 1988; Brudenell 2016a; 2016b) and Orsett Cock (Brown 1998). Flint was the dominate local fabric during the late Bronze Age, being steadily replaced with quartz sand through the Iron Age. Flint remained popular well into the middle Iron Age, with sand only becoming dominant around the 2nd century BC (Brudenell 2016b, 380). Vesicular fabrics are a minor component throughout the period. Glauconitic sand may be exclusively middle Iron Age (e.g. Brudenell 2016b, 368). Flint-tempered or vesicular body sherds could therefore date to the late Bronze Age or Iron Age; sandy fabrics are more likely Iron Age, probably middle Iron Age.

#### Forms

- B.1.6 The most significant assemblage from a single context was context 3609, a fill of pit 3613. Some 140 sherds (2143g) was found representing at least two vessels, with the majority of the sherds from a large high-shouldered jar with an out-turned fingertipped rim in a flint and vesicular fabric. This should date to the later part of the late Bronze Age or earliest Iron Age (c 1000-600 cal BC). This was found with a weakly-shouldered vessel.
- B.1.7 Context 1727 produced a shouldered jar with an upright rim dating to the earliest or early Iron Age (c 800-350 cal BC). A high-shouldered jar probably dating to the early Iron Age (c 500-350 cal BC) was found in context 7509, and a middle Iron Age (c 350-50 cal BC) globular bowl was found in context 4609.

| Context | Sherds | Weight (g) | Spot-date             | Date (BC) | Fabric                   | Comment  | Sample |
|---------|--------|------------|-----------------------|-----------|--------------------------|--|--------|
| 1704    | 3      | 36         | LBA/IA                | 1150-50   | Flint and sand; Flint    |  |        |
| 1725    | 3      | 103        | MIA                   | 350-50    | Sand                     | Burnished  |        |
| 1727    | 13     | 78         | EEIA/EIA              | 800-350   | Flint; ?Shell            | Shouldered jar with upright rim  |        |
| 3603    | 2      | 15         | LBA/IA                | 1150-50   | Flint; ?Shell            |  |        |
| 3609    | 140    | 2143       | LBA/EIA (earliest IA) | 1000-600  | Flint and ?shell         | Large shouldered jar, would probably substantially refit; weakly shouldered vessel |        |
| 3622    | 2      | 15         | IA                    | 800-50    | Sand and flint           |  |        |
| 3701    | 1      | 16         | LBA/EIA               | 1150-350  | Flint                    |  |        |
| 3719    | 1      | 4          | LBA/IA                | 1150-50   | Flint                    |  |        |
| 3807    | 1      | 5          | LBA/IA                | 1150-50   | Flint                    |  |        |
| 4208    | 7      | 69         | LBA/EIA               | 1150-350  | ?Shell; ?Shell and flint |  | 6      |
| 4402    | 1      | 12         | LBA/IA                | 1150-50   | Flint                    |  | 4      |
| 4407    | 1      | 15         | LBA/EIA               | 1150-350  | Flint (coarse)           |  |        |
| 4609    | 17     | 187        | MIA                   | 350-50    | Sand; Flint; ?Shell      | Globular bowl. Burnishing  |        |
| 4709    | 8      | 34         | LBA/IA                | 1150-50   | Flint                    |  |        |
| 4908    | 1      | 3          | LBA/IA                | 1150-50   | Flint                    |  |        |
| 6009    | 5      | 5          | EIA/MIA               | 800-50    | Sand                     | Very small and abraded   |        |
| 6011    | 1      | 6          | LBA/IA                | 1150-50   | Flint                    |  |        |
| 6040    | 1      | 4          | IA                    | 800-50    | Sand                     | Burnished  | 8      |
| 6204    | 18     | 71         | MIA                   | 350-50    | Sand; Flint              | Burnished  |        |
| 6304    | 4      | 13         | LBA/IA                | 1150-50   | Flint                    |  |        |
| 7504    | 1      | 4          | LBA/IA                | 1150-50   | Flint                    |  |        |
| 7506    | 2      | 8          | LBA/IA                | 1150-50   | Flint                    |  |        |
| 7509    | 5      | 90         | EIA                   | 500-350   | Flint; ?Shell            | High shouldered jar  |        |
| 7515    | 12     | 76         | LBA/IA                | 1150-50   | Flint                    |  |        |
| 7604    | 7      | 23         | EIA/MIA               | 500-50    | Sand; flint              |  |        |

|              |            |             |         |         |             |                                 |  |
|--------------|------------|-------------|---------|---------|-------------|---------------------------------|--|
| 7606         | 5          | 41          | EIA/MIA | 500-50  | Sand; flint | Burnished                       |  |
| 7607         | 1          | 5           | LBA/IA  | 1150-50 | Flint       | From CBM box                    |  |
| 7607         | 26         | 112         | MIA     | 350-50  | Sand; flint | Glauconitic sand.<br>Burnishing |  |
| <b>TOTAL</b> | <b>289</b> | <b>3193</b> |         |         |             |                                 |  |

Table 1. Summary of the prehistoric pottery

## B.2 Late Iron Age and Roman Pottery

By Kate Brady

### Introduction

- B.2.1 Some 356 sherds of pottery, weighing 3.8kg, were recovered from the evaluation. The assemblage was scanned to identify diagnostic forms and fabrics, provide spot-dates and generally characterise the material. The assemblage was also assessed in terms of its conservation, discard and retention. Fabrics of prehistoric date were given codes based on their principal inclusion types and coarseness. Later Iron Age and Roman pottery fabrics were assigned codes from OA's standard recording system for material of that date (Booth 2016). Forms identified by rim were given codes from OA's system. Reference was also made to the National Roman Fabric Reference Collection (NRFRC; Tomber and Dore 1998), Going's (1987) type series of pottery from Chelmsford and the published assemblage recovered from the kilns at Mucking (Lucy and Evans 2016).
- B.2.2 Each context-group was quantified by sherd count and weight (grammes), and any rims present were additionally quantified by estimated vessel equivalent (EVE), which measures the percentage of rim circumference that survives (thus, 0.3 equals 30%). The total was 25.69 EVEs from 219 vessels identified by rim (MV). Pottery data by context is provided in Table 2.
- B.2.3 The following late Iron Age and Roman fabrics were noted (NRFRC codes in brackets):
- A11 South Spanish amphora (BAT AM 1)
  - B11 Dorset black-burnished ware (DOR BB 1)
  - C10 Shell tempered ware
  - E30 Late Iron Age/early Roman sandy fabrics
  - E40 Late Iron Age/early Roman shelly fabrics
  - E50 Late Iron Age/early Roman flint fabrics
  - E80 Late Iron Age/early Roman grog-tempered ware (SOB GT)
  - E810 Late Iron Age/early Roman grog and sand tempered fabrics
  - F51 Oxford colour-coated ware (OXF RS)
  - O20 Sandy oxidised ware
  - R10 Fine reduced ware
  - R20 Sandy reduced ware
  - R30 Medium sandy reduced ware
  - R50 Dark surfaced fabrics
  - R90 Coarse-tempered ware
  - S30 Central-Gaulish samian ware
  - W10 Fine white ware
  - W12 Oxford Parchment ware

B.2.4 The following forms identified by rim were recorded:

- B Flagon or bottle
- C Indeterminate jar
- CB Barrel shaped jar
- CD Medium-mouthed jar
- CE High-shouldered necked jar
- CH Bead-rimmed jar
- CJ Lid-seated jar
- CK Cooking pot/jar
- D Indeterminate jar/bowl
- HC Curving sided bowl

### Description

| Context | Count | Weight | MV | EVE  | Comments   | Spot date |
|---------|-------|--------|----|------|--|-----------|
| 1608    | 10    | 29     | 0  | 0    | E80/E810   | -100-100  |
| 1708    | 2     | 8      | 0  | 0    | E50 E810?  | -100-100  |
| 1711    | 2     | 14     | 0  | 0    | E30  | -100-100  |
| 1719    | 20    | 177    | 0  | 0    | E40 and E80 body sherds E80 has horizontal grooves on body   | -100-100  |
| 1727    | 7     | 18     | 0  | 0    | E80  | -100-100  |
| 3612    | 1     | 2      | 0  | 0    | E80  | -100-100  |
| 3706    | 10    | 56     | 1  | 0.03 | Bifid rim bowl with curving side grog temp grey core with orange surfaces (EVE 0.03) also micaceous sand and grog temp body sherds poss Mucking fabrics smooth dark grey surfaces slightly lighter grey core with sand and fine grog. Micaceous. | 1-100     |
| 3809    | 10    | 152    | 1  | 0.17 | E30/R50? Body sherds one body sherd of begic type cordoned neck base. E40 bead rim jar/bowl (EVE 0.17)   | 1-100     |
| 3811    | 2     | 32     | 1  | 0.08 | E30 black flat rim bowl (EVE 0.08) wheel made As Mucking JA01 'bucket shaped jar   | 1-100     |
| 3812    | 1     | 9      | 0  | 0    | E40  | -100-100  |
| 3917    | 13    | 161    | 1  | 0.03 | sandy greyware E40 sand and vesicular fabric was prob shell (EVE 0.03) base has two neatly drilled holes, micaceous common fabric for this site  | 1-100     |

| Context | Count | Weight | MV | EVE  | Comments   | Spot date |
|---------|-------|--------|----|------|--|-----------|
| 4004    | 42    | 247    | 3  | 0.23 | E40 lid seated jar/bowl (EVE 0.1) (leached - fabric is black and exterior of vessel is sooted fabric also contains small amount of red grog and sand ) AD 50-110 E80 jar (EVE 0.08) another similar C E80 EVE 0.05 grog temp fabric is brown surface with orange margins and grey/brown core. Grog is red/orange/grey also vesicular voids from shell?     | 1-100     |
| 4203    | 41    | 464    | 2  | 0.18 | E40 (leached out)( EVE 0.09) D in-sloping very slightly lid-seated prob jar, E30 'belgic jar/ Going G17 CD (EVE 0.09) with double bulbous cordons base of neck/shoulder)   | 1-100     |
| 4300    | 1     | 26     | 0  | 0    | E810   | -100-100  |
| 4315    | 19    | 55     | 0  | 0    | E80 oxid and reduc   | -100-100  |
| 4409    | 5     | 15     | 1  | 0.09 | E80 body sherds and D EVE 0.09   | 1-100     |
| 4504    | 1     | 32     | 0  | 0    | E40  | -100-100  |
| 4714    | 5     | 44     | 0  | 0    | E80  | -100-100  |
| 7607    | 11    | 35     | 0  | 0    | E80  | -100-100  |
| 1725    | 4     | 32     | 0  | 0    | R30, E80   | 40-100    |
| 3610    | 4     | 31     | 0  | 0    | E60 R30 E40?   | 40-100    |
| 3714    | 22    | 224    | 0  | 0    | All body sherd, R90 thick body sherds  | 40-250    |
| 4005    | 4     | 71     | 1  | 0.07 | E40 (leached out) HC with lid seated rim ('rebated' -two parallel vertical beads). Form AC06.3 Mucking (EVE 0.07) R10 body sherds  | 40-100    |
| 4306    | 14    | 381    | 0  | 0    | R30 E40 (looks like a lid seated jar/bowl) body sherds samp <12> R30 dark surface sherds poss R90  | 40-150    |
| 4307    | 11    | 382    | 1  | 0.15 | R30 large thick heavy body sherd probably from near base of large jar. Thinner sandy R30 black surfaced and micaceous probable lid with wear around where lid would meet vessel (EVE 0.15), micaceous medium sandy greyware with dark surface body sherds, E80, E40 body sherds E60 or preh body sherd, neck only of ring necked flagon (Going form J31.1) | 50-100    |
| 4508    | 2     | 15     | 0  | 0    | R30 E80  | 40-100    |
| 4608    | 4     | 55     | 0  | 0    | E30/R30, R20   | 40-100    |
| 4904    | 3     | 44     | 0  | 0    | R30 R50 E60  | 40-100    |
| 3915    | 4     | 84     | 1  | 0.14 | CD R30 (EVE 0.14) jar with cordon base of neck looks early ish belgic style pos E30. S30 very worn body sherds, R20 body sherd   | 120-200   |
| 4607    | 27    | 248    | 1  | 0.3  | CK B11 prob B20 cooking pot (EVE 0.3) Heavily sooted all over no decoration visible  | 120-250   |



| Context | Count | Weight | MV | EVE  | Comments   | Spot date |
|---------|-------|--------|----|------|--|-----------|
| 2089    | 12    | 58     | 1  | 0.04 | W12 with red paint C10 F51 R30 R10 (EVE 0.04) Samp <9>           | 300-410   |
| 3611    | 4     | 38     | 0  | 0    | R20 body sherds  | 40-410    |
| 3911    | 2     | 38     | 1  | 0.07 | large bowl with moulded lip on side Pmed red ware R30 body sherd | 18-19C    |
| 3918    | 1     | 29     | 0  | 0    | R20  | 40-410    |
| 4205    | 1     | 6      | 0  | 0    | R20  | 40-410    |
| 4210    | 3     | 58     | 0  | 0    | flat base R20 micaceous greyware medium to coarse sandy          | 40-410    |
| 4310    | 11    | 150    | 2  | 0.11 | R30 D (EVE 0.08), R30 D (EVE 0.03) body sherds O20 R20 R30       | 40-410    |
| 4312    | 1     | 5      | 0  | 0    | body sherd   | 40-410    |
| 4405    | 2     | 145    | 0  | 0    | Base R30, W10  | 40-410    |
| 4519    | 2     | 19     | 0  | 0    | R30  | 43-410    |
| 5305    | 2     | 1      | 0  | 0    | Pmed transfer printed blue/white                                 | Pmed      |
| 5604    | 1     | 5      | 0  | 0    | R30  | 43-410    |
| 5609    | 4     | 9      | 0  | 0    | O20 worn   | 43-410    |
| 7515    | 1     | 14     | 0  | 0    | unid sandy oxidised date not known                               | unid      |
| 7606    | 7     | 129    | 1  | 0.2  | R30 flagon or bottle rim, body sheerds R20, R30                  | 40-410    |
|         | 356   | 3847   | 19 | 1.89 |  |           |

Table 2: Summary and quantification of the pottery by context (Key: EVE estimated vessel equivalent; MV minimum number of vessels; M/LIA mid/late Iron Age)

### *Late Iron Age to early Roman*

- B.2.5 Some 57% per cent of pottery by sherd count was recovered from context-groups dated to the late Iron Age or early Roman period. The pottery was recovered from Trenches 16, 17,36, 37, 38, 39, 42, 43, 44, 45, 47 and 76. The context-groups contained no pottery that must date after c AD 43 and it remains possible that deposition was confined to the late Iron Age. However, as fabrics of late Iron Age tradition continued in use in the region for some decades after the Roman conquest, a pre-Roman date is not certain. A small range of fabrics were noted, with leached out shell-tempered wares (E40) common, along with other E-wares, including grog (E80), grog and sand (E810) and sand (E30) tempered fabrics.
- B.2.6 A total of ten vessels were represented by rims (0.81 EVEs) and these included a curving sided bowl in fabric E80 with a bifid rim from context 3706. This vessel was fairly fine, and dates from AD 1-100. A body sherd in fabric E80 had horizontal rilling on the surface. Vessels in fabric (E30) included a bucket/ barrel-shaped jar with a flat rim from context 3811, similar to one from Mucking (form JA01) which was dated to the late Iron Age. There were also body sherds from wheel-made cordoned jars dating to AD 1-100. One medium-mouthed jar in fabric E30 from context 4203 is paralleled in the Chelmsford typology (Going 1987, form G17) and has two bulbous cordons at the base of the neck/ on the shoulder. These were common in early contexts at Chelmsford (pre-flavian) but the date range of this form can extend into the early 2nd century AD (Going 1987, 24).
- B.2.7 The vessels in the vesicular leached out shell fabric (E40) were the most numerous and included a heavily sooted lid-seated jar from context 4004 and another jar/bowl

with a slightly lid-seated in-sloping rim. One base in this fabric had two neatly drilled holes.

#### *Early Roman*

- B.2.8 A total of 19.1% of the assemblage by sherd count belonged to context-groups dated to the early Roman period (c AD 43-100). This material was recovered from Trenches 17, 36, 37, 40, 43, 45, 46 and 49 and included pottery of late Iron Age tradition (E40, E80 and E60) in combination with pottery of certain post-conquest date, all reduced wares in fabrics R10, R30 and R90. There were two vessels (0.22 EVE) identified by rim.
- B.2.9 The post-conquest greyware vessels included a particularly large thick bodied jar of which a part of the wall and base survived. A thinner sandy sherd of a lid in fabric R30 was well worn where the lid would have rested on a vessel. There was also a body sherd (from the neck) of a ring-necked flagon in fabric R30 (Going form J31.1) from context 4307 which dates to the latter half of the first century AD.
- B.2.10 The vessels in fabric E40 included one curving-sided bowl from context 4005 with a rebated lid-seated rim, paralleled at Mucking (form AC06.3) and dated to AD 50-110 there.
- B.2.11 There were body sherds of a South Spanish Amphora (A11), a fabric which has a large date range (AD1-250) but here is accompanied by body sherd is reduced fabric R90 and so is post-conquest in date but cannot be dated more closely than this.

#### *Middle Roman*

- B.2.12 A total of 8.7% of the assemblage by sherd count belonged to contexts groups dated to the middle Roman period (c AD 120-250). The pottery was recovered from Trenches 39 and 46, from just two contexts.
- B.2.13 A medium-mouthed cordoned jar from context 3915 was a 'belgic' form but was found alongside a sherd of Central Gaulish samian ware (S30) dating this context to AD 120-200. However, although these worn, fairly small sherds were confidently identified as Central Gaulish, there is a slight possibility that this is a South-Gaulish (S20) fabric and dated to the latter half of the 1st century AD.
- B.2.14 The rim of a black-burnished ware (B11) cooking pot was recovered from context 4607. It was heavily sooted from use and probably dates to AD 120-250.

#### *Late Roman*

- B.2.15 A single context in Trench 20 (2089) contained pottery of late Roman date. This small group included a sherd each of Oxford colour-coated ware (F51) and Oxford parchment ware (W12) and dates to the 4th century.

#### *Post-Roman*

- B.2.16 Four sherds of post- medieval pottery were recovered from Trenches 39 and 53. These included the rim of a bowl in glazed post-medieval red ware from context 3911 and two tiny sherds of blue and white transfer printed ware from context 5305. Both are of 18th-19th century date.

## *Discussion*

- B.2.17 The pottery spans the late Iron Age and Roman periods, with a strong focus on the late Iron Age to early Roman period. The material from this period includes hand-made vessels in the Iron Age tradition, including bead rim jars/bowls in sand and shell tempered fabrics and 'belgic' forms in sand and grog-tempered fabrics and these contexts have a fairly wide date range spanning the 1st century AD. Some contexts that also contain similar material have been assigned a more specific early Roman date due to the accompaniment of 'romanised' greywares of post-conquest date. It is possible that all the late Iron Age to early Roman phased material is also early Roman in date, representing a single main phase of activity on the site associated with the enclosures in the north of the evaluated area.
- B.2.18 The small amount of material recovered from the middle and late Roman periods may represent the continued use of the enclosures after they had been substantially infilled or modification of the enclosure system.
- B.2.19 Overall, the assemblage was in moderate to fragmentary condition. The mean sherd weight (weight divided by sherd count) is 10.8g, which is characteristic of an assemblage of medium to small fragments. The pottery is likely to have been redeposited prior to final deposition, perhaps in middens close to settlement and then finally dumped in the enclosure ditches. The forms identified are consistent with those manufactured in the region and most vessels were paralleled at Mucking (Lucy and Evans 2016) and/or Chelmsford (Going 1987) the parallels, where identified, are recorded in Table 2.
- B.2.20 The fairly small range of fabrics recovered, with little from other regional industries and few imports further suggests that the assemblage was dominated by wares made on the site or locally. Assessment of status is difficult due to the fairly small size of the assemblage, but the small amount of samian ware and amphora demonstrates the adoption of Roman dining practices and access to exotic products (in the latter case, olive oil).

## B.3 Fired Clay

By Cynthia Poole

### Introduction

- B.3.1 A modest quantity of fired clay amounting to 378 fragments weighing 5942g was recovered from 13 trenches, with the largest amount coming from trench 37 and the remainder forming a scatter across the northern and north-eastern trenches of the site. The hand-collected material has a high mean fragment weight of 37.5g and even when the sieved material is included the mean fragment weight remains above average at 16g. Abrasion is very variable and clearly a variety of factors are affecting condition and preservation of the material.
- B.3.2 In general, fired clay cannot be closely spot dated except for a limited number of diagnostic forms, usually portable oven and hearth furniture. However certain characteristics or combinations of forms are more typical of some periods than others, but for the most part fired clay is reliant on associated dateable artefacts for its phasing. Most of the fired clay has been phased to late Iron Age-Roman period with the main emphasis on the late Iron Age - early Roman and the general character of the assemblage is consistent with this. A small quantity associated with pottery ranging in date from late Bronze Age to middle Iron Age may be of the same date. The assemblage has been recorded on an Excel spreadsheet in accordance with guidelines set out by the Archaeological Ceramic Building Materials Group (ACBMG 2007), which whilst not specifically for fired clay provide appropriate guidance.
- B.3.3 Fabrics were characterised on the basis of macroscopic features supplemented by the use of x20 hand lens for finer constituents. In general, all the fired clay is made in a sandy clay containing various densities and size grades of quartz sand and small quartzite and flint grit up to 5mm. Three fragments contained added organic inclusions surviving as chaff voids and impressions. The majority of the fired clay is oxidised fired to red, orange or reddish brown.

### Prehistoric

- B.3.4 Fired clay phased as prehistoric was recovered from ditch fills 6204, 7506 and 7509. All the pieces were small and of indeterminate form with a single flat or curving moulded surface surviving.

### Late Iron Age - Roman

- B.3.5 The bulk of the fired clay was found in features of late Iron Age - Roman date, predominantly associated with pottery dating to the 1st centuries BC/AD.
- B.3.6 Material classified as structural (354 fragments, 3015g) tended to be made in the coarser varieties of the sandy fabric and was mainly oxidised fired to red, orange or brown. Structural material retains few diagnostic features and most of the material designated as structural has a single moulded surface forming the interior wall surface or lining. These ranged in thickness from 15 to 50mm thick, representing thinner lining or repairs to the surface and the thicker solid wall structure. Fragments from 3612 exhibited some of the typical characteristics of structural material in the form of distinct finger marks pressed into the clay, wedge-shaped cross sections, where the clay had been smoothed across a previously constructed section and some with well fired inner lining c 15mm thick with a distinct boundary to underfired exterior. These features were most apparent in the large group from context 3612 which is interpreted as pottery kiln structure. Several pieces from this had a distinct convex surface, very tightly curving on one, which probably represent the surface of an integral pedestal of either cylindrical or tongue form.

- B.3.7 Fragments from pit 1726 had a pinkish mauve or cerise colour and may represent structural material from a salt evaporation hearth. Other fired clay from Trench 76 may also be associated with salt working and include a fragment with a convex surface, which may be a fragment of firebar or pedestal stem (context 1708) and some thin curving flakes 5-9mm thick that may be sherds of briquetage vessels (context 1727). From ditch fill 7606 came a pyramidal lump with a rough flat base with organic impressions and depressions from pressing over another element and smoothed curving sides. This is similar to pinch props found on salt working sites and its colour suggests a possible association with salt working. Fragments possibly from small bars or rods with a rounded cross-section (ctx 1708, 1719) may also be related to salt production.
- B.3.8 Portable kiln furniture in the form of firebars and plates was identified from Trenches 36, 38, 39, 43 and 44. Three rectangular firebars with flat square ends, though on one this may have been shaped to a chevron. Two of the firebars were of similar size measuring 55-60 by 57-64mm wide suggesting a slightly tapered form of unknown length. The third was larger measuring 76mm square and over 140mm long. These are smaller than the possible firebars found at LTC3HL19, where they may have been over 80mm wide. This is slightly larger than the examples recorded at Mucking (ibid., 18) which were c 50mm square with a slight taper to the ends.
- B.3.9 Perforated kiln plates were found in two ditches (3618, 4318). The best-preserved piece (ctx 4318) took the form of a large roughly shaped block 60-85mm thick covered with numerous deep fingertip depressions and had a slightly concave rounded edge, which either formed the edge of the plate or a large vent through it. It was pierced by a more typical perforation 47mm in diameter with a distinctly thickened ridge around its base. The second example (ctx 3611) was smaller measuring between 20-25mm thick and was pierced by a perforation 22mm in diameter. A third plain plate (ctx 3913) without any perforations measured 29mm thick. These would have formed the suspended floor within a pottery kiln. The larger example may have formed an integral fixture of the structure, but the smaller may have been portable plates.
- B.3.10 Other furniture includes three examples of triangular perforated bricks, all very fragmentary identified by the perforations measuring 13-15mm. This form first appeared in the early Iron Age but continued in use until the early Roman period. All the examples were found in ditches (ctx 1719, 1725, 4004) of late Iron Age-early Roman date.

## Conclusions

- B.3.11 The fired clay is predominantly of late Iron Age-early Roman date and provides evidence of craft/industrial activities undertaken in the area. The material includes a significant quantity of kiln debris, comprising both structural and portable items, which attest to the presence of one or more pottery kilns in the area. Kilns have previously been found in the locality at the nearby sites of Mucking (Jones 1973) and Orsett 'Cock' (Carter 1998). The range of structural material and kiln furniture found at Stifford Clays Road is indicative of kilns with a suspended floor separating the lower furnace from the upper chamber using either perforated plates or firebars, suggesting different designs of kilns were in use during this period. The man for pottery production is focused on Trench 36, together with evidence in Trenches 38, 43 and 44. This material presents further evidence for the pottery industry in the area around Mucking and Orsett and could make an important contribution to understanding the development of the industry before and after the Roman Conquest.
- B.3.12 The fired clay also includes material that may relate to salt production focused on Trench 17. Although the site lies nearly 4km from the coast, any settlement in the area may have access to the Thames estuary and conducted seasonal activities along the shoreline. There is evidence south of the Thames in Kent for some element

of the salt processing to take place at sites inland, possibly the final stages of drying and packaging (Poole 2011, 139) and the same may apply here.

## Recommendations

- B.3.13 The assemblage is of importance in providing evidence for the presence of kilns and the form of their construction and for evidence of possible salt production. The diagnostic material has future research value and should be retained. Some of the smaller non-diagnostic material from the sieved samples has been discarded.
- B.3.14 In the event of further excavation taking place any future work should take into account the possibility that kilns may be present and that late Iron Age Belgic kilns may leave very little trace, often only an ephemeral shallow burnt hollow remaining in situ. Subsurface structures may be better preserved in the case of early Roman kilns, though in both cases identification may be dependent on the presence of portable kiln furniture.

| Context | Sample No | Nos | Wt (g) | Class                        | Comments   |
|---------|-----------|-----|--------|------------------------------|--|
| 1708    | ~         | 1   | 11     | Furniture?                   | Mauve colouring suggests possible briquetage furniture     |
| 1719    | ~         | 1   | 67     | Triangular perforated brick  | Perforation 14mm dia.                                      |
| 1719    | ~         | 1   | 3      | Oven lining?                 |  |
| 1719    | ~         | 1   | 9      | Furniture?                   | Small bar/rod?   |
| 1725    | ~         | 1   | 12     | Triangular perforated brick? | Only feature is perforation 13mm dia                       |
| 1725    | ~         | 4   | 29     | Structural? Indeterminate    |  |
| 1727    | ~         | 8   | 58     | Structural?                  |  |
| 1727    | <6>       | 14  | 25     | Structural? & Vessels        | Possible thin briquetage sherds                            |
| 3610    | ~         | 5   | 29     | Kiln/Oven str?               |  |
| 3611    | ~         | 6   | 106    | Perforated kiln plate        | Perforation 22mm dia                                       |
| 3612    | ~         | 51  | 686    | Kiln structure               | Fragments with finger marks                                |
| 3612    | <7>       | 256 | 2104   | Kiln structure               |  |
| 3706    | ~         | 2   | 25     | Indeterminate                |  |
| 3809    | ~         | 2   | 358    | Kiln bar                     | Square section, chevron end                                |
| 3913    | ~         | 1   | 113    | Plate?                       |  |
| 4004    | ~         | 1   | 113    | Triangular perforated brick  | Perforation 15mm dia                                       |
| 4306    | <12>      | 7   | 25     | Structural/indeterminate     |  |
| 4318    | ~         | 1   | 760    | Perforated kiln plate        | Rounded edge; perforation 47mm dia; finger marks.          |
| 4405    | ~         | 3   | 1275   | Kiln bars                    | Two kiln bars of differing size; square `ed with flat ends |
| 4508    | ~         | 1   | 14     | Structural                   | Finger mark  |
| 4607    | ~         | 2   | 9      | Indeterminate/structural?    |  |
| 4609    | ~         | 3   | 8      | Indeterminate/structural?    |  |
| 6204    | ~         | 1   | 15     | Indeterminate/structural?    |  |
| 7506    | ~         | 1   | 11     | Indeterminate                | Chaff impressions on surface                               |
| 7509    | ~         | 3   | 14     | Indeterminate                |  |
| 7606    | ~         | 1   | 63     | Luting/prop                  | Pyramidal support or pinch prop?                           |

Table 3: Summary of fired clay by context

## B.4 Clay Pipes

By John Cotter

### Introduction and methodology

- B.4.1 A single piece of clay pipe weighing 2g was recovered. Given the small amount this has not been separately catalogued but is fully described below.

### Description

- B.4.2 **Context 4714 Late 18th to 19th century.** 1 piece (weight 2g). Length 45mm. Slender 19th-century type stem in a clean white fabric, with a stem bore diameter of 2mm. Fresh condition.

## B.5 Metalwork and slag

By Ian R Scott

- B.5.1 There are 14 metal finds (1, comprising 13 iron objects and 1 copper alloy object. The iron objects are all covered corrosion products which partly obscure their shape. X-radiography will be required to help with the identification of iron objects. The copper alloy is not affected by corrosion build up. Little of the ironwork is closely datable.
- B.5.2 There is the possible leaf-shaped blade (sf 1) with raised mid rib from context 1704 and a length of probable iron rod (sf 2) from context 1706. The spearhead if the identity is confirmed would likely be of Iron Age or Roman date rather than of Saxon date.
- B.5.3 A large nail with irregular domed head and a probable chisel tip was recovered from context 2303. The chisel tip if confirmed would suggest 18th- or 19th-century date.
- B.5.4 A curved fragment of iron bar or rod (sf 13) came from context 3703.
- B.5.5 A small fragment of iron (sf 3), probably the T-head of nail, came from context 3811.
- B.5.6 Five iron pieces were found in context 4303. These comprise the T-head of nail (sf 5), a piece of rod or bar (sf 8), two possible nail stem fragments (sf 14), and a possible key (sf 7). The last comprises a heavily encrusted but apparently tapered rod, with flat rectangular extension, possibly the bit of key, at the narrow end. The identification of the key would need confirmation through x-radiography.
- B.5.7 A single small flat rectangular block of iron (sf 11) was found in context 4402.
- B.5.8 Context 4607 produced the only pieces of copper alloy. These are two refitting slightly tapered fragments probably from a needle or hair pin (sf 4). Context 4608 produced a nail stem fragment (sf 9) and a hobnail (sf 10).
- B.5.9 Context 6204 produce a broken piece of cast iron (sf 12) which clearly of more recent date.

|              |       |  |
|--------------|-------|--|
| Context 1704 | (1)   | Possible spearhead blade. Leaf-shaped fragment encrusted with corrosion, with slight but clearly visible raised midrib on one face. Fe. L: 120mm, W: 32mm. Sf 1            |
| Context 1706 | (2)   | Rod fragment, circular cross-section, possibly rectangular section at one end. Corrosion encrusted. Fe. L: 110mm, D: 12mm. Sf 2  |
| Context 2303 | (3)   | Nail, irregular domed head, square section stem, possibly chisel tipped. Fe. L: 135mm.   |
| Context 3703 | (4)   | Rod or bar. Curved fragment, encrusted with corrosion. Fe. L: 62mm. Sf 13  |
| Context 3811 | (5)   | T-shaped nail head fragment. Encrusted. Fe. Not measured. Sf 3   |
| Context 4303 | (6)   | ? T-shaped nail head fragment. Encrusted. Fe. Not measured. Sf 5   |
|              | (7)   | Rod or bar fragment. Encrusted. Fe. L: 51mm. Sf 8  |
|              | (8-9) | Nail stem fragments. 2 x tapered fragments. Encrusted. Fe. Not measured. Sf 14   |
|              | (10)  | Possible key? L-shaped fragment. Tapered encrusted stem, with flat rectangular extension to one side at narrow end. Could be a key. Encrusted. Fe. L: 142mm, W: 43mm. Sf 7 |
| Context 4402 | (11)  | Small flat rectangular fe block. 34mm x 23mm x 10mm. Sf 11   |



|              |      |  |
|--------------|------|--|
| Context 4607 | (12) | Needle stem comprising 2 x refitting fragments of slightly tapered thin rod. Cu alloy. L: 50mm. Sf 4 |
| Context 4608 | (13) | Nail stem fragment. Tapered fragment. Encrusted Fe. Not measured. Sf 9                               |
|              | (14) | Hobnail, encrusted. Fe. Not measured. Sf 10  |
| Context 6204 | (15) | Cast iron. Broken triangular fragment of cast fe. Sf 12  |

Table 4: Finds register – metal finds.

- B.5.10 There are two small smithing hearth bottoms from context 1903, and two small pieces of probable fuel ash slag from context 2089.
- B.5.11 The smithing hearth bottoms from context 1903 are relatively small and weigh 264g and 324g. They would have formed inside the smith's hearth adjacent to the air inlet where the bellows were fitted.
- B.5.12 The two pieces of slag from context 4705 are small. They may be pieces of fuel ash slag but they too small for certainty.
- B.5.13 It is clear that some smithing was being carried out on the site. The size of the 'smithing hearth bottoms' suggests that it was on a small scale.

|              |       |  |
|--------------|-------|--|
| Context 1903 | (1-2) | Two 'smithing hearth bottoms' of small size. The smaller has a clear deep plano-convex profile, the larger piece more irregular with slightly convex underside and irregular ridged upper face. (1) 85mm x 66mm; depth: 45mm, Wt: 264g (2) 96mm x 90mm; depth 39mm, Wt: 342g |
| Context 2089 | (3-4) | Slag. Two small fragments, possibly fuel ash slag, but too small to be positively identified. Wts: 1g and 12g.   |

Table 5: Finds register – slags.

## B.6 Flint

By Michael Donnelly

### Introduction

- B.6.1 Evaluation at site LTC 22S brought to light a small assemblage of 39 pieces of struck flint and 46 burnt unworked fragments weighing 929g. The assemblage was very clearly flake based, entirely lacked blade forms and included a number of flake cores suggestive of Bronze Age flint knapping. Only one prehistoric tool was recovered while the second retouched form probably represented a poor effort of a gunflint of post-medieval date. The majority of the flints came from a single intervention in a ring-ditch with 22 pieces while no other context had more than two (including another flint from the same trench as the ring-ditch). This most likely represents a mid-late Bronze age re-use of flint nodules from a barrow associated with the ring ditch but could also include contemporary material associated with the barrow or even from the pre-barrow land surface.

| Category type                           | Total       |
|---|-------------|
| Flake                                   | 29          |
| Blade index                             | 0% (0/29)   |
| Irregular waste                         | 2           |
| Core single platform flakes             | 1           |
| Core multiplatform flakes               | 3           |
| Core fragment flakes                    | 2           |
| Denticulate                             | 1           |
| Gubflint                                | 1           |
| <b>Total</b>                            | <b>39</b>   |
|   |             |
| Burnt un-worked                         | 46/929g     |
| No. burnt (%)                           | 5.13% 2/39  |
| No. broken (%) (not including waste)    | 15.38% 6/39 |
| No. retouched (%) (not including waste) | 5.13% 2/39  |

Table 6: The flint assemblage

### Raw material and condition

- B.6.2 Cortex was present on 30 of 39 pieces (76.92%) and included a relatively limited range of types including four examples of Bullhead Beds (13.33%) material (Dewey and Bromehead 1915). Chalk cortex was most common (19, 63.33% (five of which were heavily weathered)) followed by a thin abraded/weathered cortex typical of North Downs flint (6/39, 20%) and finally, there was a single rolled example (3.33%).

- B.6.3 Most of the flint was in fresh (25/37, 67.57%) or lightly edge damaged condition (10/37, 27.03%) with just one moderately damaged and another that was rolled (2.70% each). Cortication was largely light (31/37, 83.78%) with limited amounts of moderate cortication (10.81%) and only one heavily corticated piece and another without cortication (2.70% each). Overall, the condition of the material suggests an assemblage that includes lightly disturbed pieces alongside a probably largely in situ assemblage from ring ditch fill 603.

### **Discussion**

- B.6.4 The assemblage is clearly largely later prehistoric in date and most likely relates to the use of any putative barrow mound associated with ring-ditch 603. This may have related to the use of the land prior to the barrows construction but the lack of early forms argues against this. Instead, it would appear more likely that the flints relate to the re-use of this monument to scavenge flint nodules for knapping purposes in the later prehistoric period, something that is very common in southeast England. The flake and core-heavy, tool-light collection supports the view that this assemblage primarily relates to knapping activities rather than domestic flint use.
- B.6.5 The single prehistoric tool recovered is undiagnostic but would easily be accommodated by a mid-late Bronze Age date. The recovered cores were also undiagnostic but would also be commonly found in later prehistoric assemblages.
- B.6.6 The probable gunflint from topsoil 4300 suggests that hunting may have been common here during the early post-medieval period but could also simply be a casual loss by someone passing through this area.
- B.6.7 The evaluation yielded a relatively poor assemblage with the exception of material from ring ditch 603. Any further works on the ring ditch would likely yield a relatively large assemblage from this and any other similar features nearby. However, the remainder of the archaeological features have very few flints and are unlikely to add a significant lithic component to this assemblage. One possible exception to this would be from any later Bronze Age settlement where flint use can still play a prominent role.

### **Methodology**

- B.6.8 The artefacts were catalogued according to OA South's standard system of broad artefact/debitage type (Anderson-Whymark 2013; Bradley 1999), general condition noted and dating was attempted where possible. The assemblage was catalogued directly onto an Open Office spreadsheet. During the assessment additional information on condition (rolled, abraded, fresh and degree of cortication), and state of the artefact (burnt, broken, or visibly utilised) was also recorded. Retouched pieces were classified according to standard morphological descriptions (e.g. Bamford 1985, 72-77; Healy 1988, 48-9; Bradley 1999). Technological attribute analysis was initially undertaken and included the recording of butt and termination type (Inizan *et al.* 1999), flake type (Harding 1990), hammer mode (Onhuma and Bergman 1982), and the presence of platform edge abrasion.

## B.7 Stone

By Ruth Shaffrey

- B.7.1 A total of 29 pieces of stone were retained and submitted for analysis. These were examined with a x10 magnification hand lens for signs of use or modification. All the stone is burnt. Context 1727 produced 25 fragments of heat shattered flint and quartzite cobbles (736g) and single fragments of the same were recovered from contexts 7606 and 1719. A single piece of burnt (reddened) gritstone was found in context 3809 (6g). This appears to have a worked surface and could be a piece of quern but is too small for certain identification.

### C.1 Environmental Samples

By Sharon Cook

#### Introduction

- C.1.1 Twelve bulk samples were taken during the evaluation. The samples were taken primarily for the retrieval and assessment of charred plant remains (CPR) and the recovery of bones and artefacts, and to establish the potential for preservation of these materials on site.

#### Method

- C.1.2 The samples were processed in their entirety at Oxford Archaeology using a modified Siraf-type water flotation machine. The flots were collected in a 250µm mesh and heavy residues in a 500µm mesh and dried. The residue fractions were sorted by eye and with the aid of a magnet while the flot material was scanned using a low power (x10) binocular microscope to identify cereal grains and chaff, smaller seeds and other quantifiable remains.
- C.1.3 Identifications were carried out using standard morphological criteria for the cereals (Jacomet 2006), identification of wild plant remains is with reference to the Digital Seed Atlas of the Netherlands (Cappers *et al.* 2006) and by comparison with modern reference material. Classification and nomenclature of plant material follows Stace (2010).

#### Results

- C.1.4 A summary of the samples is presented in Table 7 and the results of the assessment is Table 8. The samples came from a variety of feature types from across the site and sample volume ranged from 2L to 40L with the smallest samples deriving from spits taken through a cremation and sample taken primarily to recover fragments of pottery.
- C.1.5 Charcoal is present within all the flots although in most samples this was only in small quantities.
- C.1.6 Fine uncharred modern roots are common, as are seeds of goosefoot (*Chenopodium* sp.) which appear to be largely uncharred and are probably relatively modern. The burrowing snail *Cecilioides acicula* is also present in a number of samples, these are also likely to be modern.
- C.1.7 **Trench 6.** Sample 9 from Trench 6 came from the fill of curvilinear gully 602. The sample contains very little charred material although a few land snails are present.
- C.1.8 **Trench 17.** Sample 6 from the fill of pit 1726 is generally rich in charcoal with only small quantities of cereal grain and very rare charred seeds.

- C.1.9 **Trench 19.** Sample 5 from the fill of ditch 1902 contains highly fragmented charcoal together with a single wheat grain and small quantities of cereal chaff. The occasional charred seeds are generally from plants which prefer damp conditions.
- C.1.10 **Trench 36.** Two samples originate from Trench 36. Sample 4 from the fill of pit 3602 is rich in charcoal although this is generally of small size. Cereal grain is common but is typically damaged and not easily identifiable although both barley and wheat are present together with some oat/brome. Chaff fragments are generally small although some fragments of glume base are large enough to be identified as spelt wheat. Wild seeds are reasonable common and largely consist of those plants which are commonly found as crop contaminants or prefer disturbed ground. Sample 7 from the fill of ditch 3617 contains similar material but in much smaller quantities.
- C.1.11 **Trench 43.** Sample 12 from ditch 4304 contains mainly small fragments of charcoal with a few cereal grains in damaged condition, largely wheat with small amounts of oat. Associated glume bases are too fragmented to identify beyond emmer/spelt. The accompanying weed seeds are generally from plants which are commonly interpreted as crop contaminants.
- C.1.12 **Trench 60.** Sample 8 from ditch 6008 contains only small quantities of charcoal which is generally only large in one dimension. No other charred material is present.
- C.1.13 **Trench 66.** The three samples from Trench 66 are from the two spits of Cremation 6604 and a sample from around the cremation which was taken to collect any bone or charcoal which had been dislodged from the deposit. The charcoal from all three samples is generally <2mm with little scope for further work. Cremated bone was present within all three deposits although sample 3 largely comprised fragments smaller than 4mm.
- C.1.14 **Trench 75.** Samples 10 and 11 both came from ditch 7505. Both samples contain only small quantities of charred material, most of which is small-sized charcoal. Both samples were rich in uncharred *Chenopodium* sp. seeds which are likely to be relatively modern.

## Discussion and Conclusion

- C.1.15 The samples largely date to between the late Bronze Age and the early Roman period. The condition and quantity of the charred plant material varies across the site but there is sufficiently common to confirm that the site should be comprehensively sampled during any excavation phase, with particular attention paid to prehistoric features. The poor preservation of some of the charred material is probably largely related to pre depositional processes.

### *The Late Bronze Age to Early Iron Age*

- C.1.16 Five samples have been dated to this period. Samples 8, 10 and 11 contain very little charred material and that present is largely highly fragmented. The charcoal is likely to derive from domestic hearths although the small size of the fragments means that further identification of the woods has not been possible. As these samples all came from ditch fills the lack of material is not unusual, ditches tend not to be used for the disposal of waste unless they are close to areas where this material is produced and

are no longer in active use. The small quantities of chaff present within sample 11 may be windblown.

- C.1.17 Sample 4 from pit 3602 is much richer in charred plant remains, to an extent that is unusual for many Bronze Age sites. The sample came from a pit fill and is likely to include a dump of general waste (bone and pottery were also present). If securely dated this sample merits inclusion in any further analysis undertaken for this site. Although the poor condition of the grain hampers full identification to an extent, at least some of the chaff is from spelt wheat (*Triticum spelta*) which while present in the Bronze Age, is far more common during the Iron Age. The presence of barley (*Hordeum* sp.) and oat (*Avena* sp.) and of common cornfield weeds and other plants often associated with human activity, such as grasses, medicks (*Medicago* sp.), docks (*Rumex* sp.), vetches (*Vicia/Lathyrus*) and ribwort plantain (*Plantago lanceolata*) means that there is some potential to investigate cultivation practices. It is worth noting, however, that this sample has some similarities with those dated to the later Iron Age and early Roman periods.
- C.1.18 Sample 6 from pit 1726, has been dated to the earliest part of the Iron Age. This sample has a good quantity of charcoal with limited cereal remains. While the CPR assemblage itself is not suitable for further analysis, the charcoal may be worth further examination should the early date be confirmed. The feature is near those dated to the late Iron Age and early Roman periods and there is a possibility that the charred assemblage may be of this later date.

#### *Late Iron Age to Early Roman*

- C.1.19 Sample 7 from ditch 3617 contains a small assemblage which is similar in composition to sample 4 (already discussed) although much more limited in the quantity of remains. The small size of the assemblage is likely to be due to its location, from within the fill of a ditch, and may be the result of accidental rather than deliberate deposition.
- C.1.20 As with sample 7, the quantity of charred plant material in sample 12 from ditch 4304, which is dated to the early Roman period, is very limited but does indicate the presence of arable farming with some crop processing probably taking place nearby.

#### *Undated features*

- C.1.21 Five samples are from deposits which are currently undated.
- C.1.22 Samples 1 – 3 from cremation 6604, have produced insufficient charred plant material to merit further analysis. The small quantity of charcoal may indicate that primary pyre debris does not form a part of this deposit.
- C.1.23 Sample 9 also contains insufficient material to interpret further. Sample 5 from ditch 1902 contains small quantities of seeds and cereal remains that could date to any period from the Bronze Age through late Roman. The small size of most of the chaff fragments and wild plant seeds may indicate that they were windblown at a time when the ditch was open. The wild plant seeds (sedges) are generally associated with damp soil conditions. The feature is close to the location of samples 12 and 7 which are late Iron Age to early Roman and this sample could be of similar date.

C.1.24 Most of the samples which have produced diverse charred plant assemblages originate from the northernmost part of the site, alongside Stifford Clays Road. It seems likely that the main settlement area, or at least the features related to food production or crop processing, are likely to be located in this general area, either in this northern part of the evaluation or in the field to the north.



| Sample No | Context No | Cut No | Trench No | Feature Type                  | Soil Description  | Findings                                      |
|-----------|------------|--------|-----------|-------------------------------|---|---|
| 1         | 6605       | 6604   | 66        | Spit 1 of Cremation           | 10YR 4/6 Dark yellowish-brown sandy silt loam. Rare sub angular and sub rounded flint gravel. | Cremated Bone                                 |
| 2         | 6605       | 6604   | 66        | Spit 2 of Cremation           | 10YR 4/6 Dark yellowish-brown sandy silt loam. Rare sub angular and sub rounded flint gravel. | Cremated Bone                                 |
| 3         | 6606       | N/A    | 66        | Natural surrounding Cremation | 7.5YR 4/4 Brown sandy loam. Frequent sub angular and sub rounded flint gravel.                | Cremated Bone                                 |
| 4         | 3603       | 3602   | 36        | Fill of Pit                   | 10YR 4/4 Dark yellowish-brown sandy silt loam. Rare sub angular and sub rounded flint gravel. | Mammal bone, Burnt Flint, Pottery             |
| 5         | 1903       | 1902   | 19        | Fill of Ditch                 | 10YR 5/8 Yellowish brown silty clay. Moderate sub rounded to angular flint gravel.            | -   |
| 6         | 1727       | 1726   | 17        | Fill of Pit                   | 10YR 3/6 Dark yellowish-brown sandy silt loam. Frequent sub rounded flint gravel.             | Burnt Flint, Pottery, Fired Clay              |
| 7         | 3612       | 3617   | 36        | Fill of Ditch                 | 10YR 4/3 Brown silty sandy loam. Rare sub rounded flint gravel.                               | Burnt Flint, Fired Clay                       |
| 8         | 6011       | 6008   | 60        | Fill of Ditch                 | 10YR 4/4 Brown silt loam. Moderate sub angular to rounded flint gravel.                       | Pottery                                       |
| 9         | 603        | 602    | 6         | Fill of Ring Ditch            | 10YR 4/6 Dark yellowish-brown sandy silt loam. Occasional sub angular flint gravel.           | Pottery, Slag                                 |
| 10        | 7506       | 7505   | 75        | Fill of Ditch                 | 7.5YR 3/4 Dark brown sandy silt loam. Frequent sub rounded flint gravel.                      | Fired Clay                                    |
| 11        | 7507       | 7505   | 75        | Fill of Ditch                 | 10YR 5/8 Yellowish brown loamy sand. Occasional sub angular and sub rounded flint gravel.     | -   |
| 12        | 4306       | 4304   | 43        | Fill of Ditch                 | 10YR 3/2 Very dark greyish brown silt loam. Frequent sub rounded flint gravel.                | Mammal bone, Burnt Flint, Pottery, Fired Clay |

Table 7: The samples

| Sample No | Context No | Sample Vol (L) | Flot Vol (ml) | Date | Charcoal >2mm     | Grain | Chaff | Weeds | Molluscs | Other | Notes  |
|-----------|------------|----------------|---------------|------|-------------------|-------|-------|-------|----------|-------|--|
| 1         | 6605       | 5              | 25            | U/D  | 2 >4mm, 25+ 4-2mm |       |       |       |          |       | Moderate quantity of fine roots. Charcoal fragments are small and thin. Occasional fragments of cremated bone. |
| 2         | 6605       | 5              | 10            | U/D  | 0 >4mm, 3 4-2mm   |       |       |       |          |       | Volume is mainly fine roots. Charcoal is very small in size. Occasional fragments of cremated bone.            |

|   |          |    |         |              |                                |     |          |     |    |  |   |
|---|----------|----|---------|--------------|--------------------------------|-----|----------|-----|----|--|---|
| 3 | 660<br>6 | 6  | 10      | U/D          | 0 >4mm,<br>1 4-2mm             |     |          |     |    |  | Volume almost entirely fine uncharred roots. Occasional modern seeds. <i>Cecilioides</i> present.   |
| 4 | 360<br>3 | 40 | 12<br>5 | LBA/<br>IA   | 14<br>>4mm,<br>50+ 4-<br>2mm   | +++ | +++<br>+ | +++ |    |  | Charcoal is largely knotty fragments although some small roundwood fragments are present. Occasional indeterminate clinkered material. Cereal grains are clinkered and distorted, many indeterminate but barley and wheat are both present together with some oat/brome. Small fragments of glume base, larger fragments appear to be spelt. Oat awns present. Seeds include grass seeds, <i>Medicago</i> sp., <i>Rumex</i> sp., <i>Vicia/Lathyrus</i> and <i>Plantago lanceolata</i> . <i>Raphanus Raphanistrum</i> capsule present. <i>Cecilioides</i> present. |
| 5 | 190<br>3 | 40 | 30      | U/D          | 1 >4mm,<br>30 4-<br>2mm        | +   | +++      | ++  |    |  | Volume largely roots. Charcoal is small in size, mainly small knotty fragments. Occasional indeterminate clinkered material. Grain is probably wheat but in damaged condition. Glume base fragments are mainly small but occasional more complete fragments present. Wild seeds are <i>Carex</i> sp., <i>Eleocharis</i> sp. and grass seeds.  |
| 6 | 172<br>7 | 40 | 22<br>0 | EEIA/<br>EIA | 50+<br>>4mm,<br>100+ 4-<br>2mm | ++  |          | +   |    |  | Charcoal is largely knotty fragments but does include rare roundwood fragments. Cereal grain is two wheat grains, one oat and two indeterminate. Occasional indeterminate clinkered material. Rare <i>Carex</i> sp.   |
| 7 | 361<br>2 | 40 | 16      | LIA/<br>ER   | 0 >4mm,<br>16 4-<br>2mm        | ++  | +        | +   |    |  | Volume is largely fine roots. Charcoal is knotty (root-like) or small in size. Two cf wheat, one cf barley, one oat/brome and one indeterminate grain. Rare glume base fragments. One grass seed, one <i>Plantago lanceolata</i> .  |
| 8 | 601<br>1 | 2  | 10      | LBA/<br>IA   | 3 >4mm,<br>25+ 4-<br>2mm       |     |          |     |    |  | Small quantity of fine roots. Charcoal is small in size.  |
| 9 | 603      | 40 | 36      | U/D          | 3 >4mm,<br>25+ 4-<br>2mm       |     |          |     | ++ |  | Volume mainly fine roots. Charcoal is mainly ring porous, includes knotty fragments. Occasional land snails. <i>Cecilioides</i> present.  |

|   |          |    |    |            |                         |     |    |    |  |  |   |
|---|----------|----|----|------------|-------------------------|-----|----|----|--|--|---|
| 10  | 750<br>6 | 30 | 26 | LBA/<br>IA | 0 >4mm,<br>7 4-2mm      |     |    |    |  |  | Volume almost entirely fine uncharred roots. Indeterminate clinkered material and anthracite present.   |
| 11  | 750<br>7 | 20 | 40 | LBA/<br>IA | 0 >4mm,<br>30 4-<br>2mm |     | +  |    |  |  | Volume mainly fine roots. Charcoal is mainly small knotty fragments. Small fragments of glume base.   |
| 12  | 430<br>6 | 40 | 25 | ER         | 0 >4mm,<br>15 4-<br>2mm | +++ | ++ | ++ |  |  | Volume mainly fine roots. Some indeterminate clinkered material. Grain is clinkered and vitrified, mainly indeterminate but seven wheat grains and two oats are present. Rare glume base fragments. <i>Vicia/Lathyrus</i> , and single grass seed and <i>Tripleurospermum</i> sp. |
| Key: + 1-4, ++ 5-24, +++ 25-99, ++++ 100+ |          |    |    |            |                         |     |    |    |  |  |   |

Table 8: The charred remains

## C.2 Cremated Human Remains

By Mark Gibson

### Introduction and provenance

- C.2.1 One deposit containing burnt human bone (6605) were recovered during excavations south of Stifford.
- C.2.2 Burnt bone deposit 6605 was unurned and was found within pit 6604 in Trench 66. The pit was 0.31m wide and 0.12m in depth. The burnt bone was within a mid-blackish grey silt matrix. The deposit is currently undated.

### Methodology

- C.2.3 Deposit 6605 was excavated in the field in two spits of 50mm, before being processed and analysed. It was processed by wet sieving which sorted it into fractions of >10mm, 10-4mm, 4-2mm and 2-0.5mm. The bone from the >10mm, 10-4mm and 4-2mm fractions was separated from the extraneous material (e.g. stones). The smallest fraction sizes (2-0.5mm) were not sorted but were rapidly scanned for identifiable skeletal remains and artefacts. Estimations of the proportions of bone present within the 2-0.5mm fractions were made visually and recorded in the archive.
- C.2.4 All bone was analysed to record colour, weight and maximum fragment size. Total bone weights have not included bone from the 2-0.5mm fraction.
- C.2.5 Each fraction was examined for identifiable bone elements and the presence of pyre and/or grave goods. The minimum number of individuals (MNI) present was estimated based on the identification of repeated elements and/or the presence of juvenile and adult bones in the same deposit. Where possible, estimation of age and sex was attempted following published methods (Buikstra and Ubelaker 1994, Scheuer and Black 2000).

### Results

- C.2.6 A summary of total bone weight, colour, age and sex estimation is given in Table 9. Information on fragmentation and skeletal elements represented is provided in tables 2 and 3, respectively.

#### *Bone Weights*

- C.2.7 The total bone weight was 180.8g (Table 9). This falls well below the expected ranges for both modern (1,000-2,400g, with an average of 1,650g, McKinley 2000, 269) and archaeologically recovered cremation deposits (600-900g, McKinley 2013, 154).

#### *Fragmentation*

- C.2.8 The largest proportion of bone was from the 4-2mm fraction (47.4%, 85.6g), indicating a high to moderate level of fragmentation (Table 10). Just under half of the bone from the first spit (47.7%, 80.6g) was from this fraction, with a slightly smaller proportion in the second spit (42%, 5g). The 4-2mm was the next largest fraction (41.8%, 75.6g), with over half of spit two (54.6%, 6.5g) and 40.9% (69.1g) of spit one being in this fraction. Bone in the >10mm fraction comprised 10.8% (19.6g) of the deposit. This consisted of 19.2g (11.4%) from spit one and 0.4g (3.4%) from spit two.

C.2.9 The largest bone fragments in both spits were unidentified long bones. The largest fragment measured 29mm and was from spit one.

#### *Skeletal Representation*

C.2.10 Bones were identified to skeletal region and element, where possible (Table 11). All regions except the lower limbs were represented.

C.2.11 The majority of bone fragments (82.6%, 149.4g) lacked anatomical landmarks, so could not be identified. Unidentifiable fragments comprised 81.9% (138.3g) from spit one and 93.3% (11.1g) from spit two.

C.2.12 The skull was the most frequently identified skeletal region and comprised 4.8% (8.7g) of the total bone weight (Table 11). This primarily included skull vault fragments, but mandibular body, tooth roots, a partial molar crown and a right incus bone were also present. Axial and upper limb bones were poorly represented and comprised only 0.2% (0.4g) and 1.7% (3g) of the total bone weight, respectively. There were many identifiable fragments from the upper limb, however, including metacarpal fragments, phalanges and ulna and radial shaft fragments.

#### *Colour of the cremated bone*

C.2.13 When cremated, the organic content of bone is altered by a process called oxidation, the degree of which is reflected in the colour of the bone, which may range from brown/orange (unburnt), to black (charred: c 300°C), through hues of blue and grey (incompletely oxidised, up to c 600°C) to white (fully oxidised, >600°C) (McKinley 2004, 11). Thus, bone colour may be used as an indication of the efficiency of the cremation, in terms of the quantity of fuel used to build the pyre, the temperature attained in various parts of the pyre, and the length of time over which the cremation was undertaken (ibid, 11).

C.2.14 The colour of most of the burnt bone from the site was white, accounting for 80% (4512) of the total bone weights. This indicates that the corpse/s would have been placed on the pyre in such a way as to maintain a consistent high temperature and oxygen supply (McKinley 2013, 158), enabling a temperature in excess of 600°C. A high proportion of fully oxidised bone is a common observation in archaeological cremation burials (McKinley 2006, 84).

C.2.15 The remaining burnt bone was blue/grey or black in colour, indicating exposure to lower temperatures. This may have been due a number of reasons. For example, the cremation process may have been inhibited in places of thicker overlying soft tissue: until these are removed, the bone is insulated from oxygen and the heat of the fire, resulting in variation in the degree of bone oxidation across the skeleton (McKinley 1989, 65; McKinley 2013, 158). No pattern in the type of less completely cremated elements was observed.

#### *Demography*

C.2.16 Deposit 6605 It had no repeated elements, nor landmarks indicating conflicting age or sex estimations. These observations suggest the deposit comprises a minimum of one individual. An unfused epiphysis of a metacarpal head and an unfused epiphysis of an intermediate hand phalanx were recovered from spit one and indicate an age of less than 16.5 years (Scheuer and Black 2000, 338). The morphology of the bone

fragments was not consistent with a young juvenile, so it is likely that they represent an adolescent (13-17 years) or (possibly) an older child (6-12 years). There are currently no accepted macroscopic methods for estimating the sex of juvenile skeletons, so this was not attempted (Brickley 2004).

*Pathology and non-metric traits*

C.2.17 No pathology or non-metric traits were observed.

*Pyre/grave goods*

C.2.18 No pyre or grave goods were observed within the burnt bone deposits. No staining or residue, indicative of pyre/grave goods, were observed.

**Discussion**

C.2.19 The assemblage comprises one unurned burnt bone deposit (6605) consisting of one juvenile of less than 16.5 years of age, most likely an adolescent (13-17 years) or older child (6-12 years). Overall, bones were well burnt, or predominantly white (fully oxidised), indicating pyre temperatures of >600°C (McKinley 2004, 11). No pathology was observed.

C.2.20 The total weight (180.8g) of deposit 1507 was well below the expected range (600-900g) for archaeologically recovered adult cremation burials (McKinley 2013, 154). Even accounting for this individual being a juvenile the weight of this deposit is somewhat low and thus it being a formal unurned cremation burial seems unlikely. It is probable that it was a token deposit, but the degree to which pit 6604 was horizontally truncated is uncertain so this cannot be confirmed.

C.2.21 Given the potential that further works will be undertaken in the area south of Stifford it is recommended that these remains are retained for future research.

C.2.22 The assemblage is currently held at Oxford Archaeology under Ministry of Justice burial licence 19-0317. This licence is valid until the 22nd of December 2024. It should be deferred by application to the Ministry of Justice, stating retention in the local receiving museum.

| Deposit | Samples | Total weight (g) | Colour                                     | Age                   | Sex | Non-metrics/ pathology/ burnt and unburnt animal bone |
|---------|---------|------------------|--|-----------------------|-----|---|
| 6605    | 1-2     | 180.8            | White: 80%<br>Grey/blue: 10%<br>Black: 10% | Juvenile,<br>>16.5yrs | ?   | MNI = 1   |

Key: ?= Unknown. Note: total bone weights do not include material from the unsorted 2-0.5mm residues

Table 9: Burnt bone - Osteological summary

| Deposit      | Spit | Total weight (g) | >10mm (g)               | 10-4mm (g)              | 4-2mm (g)               | Max. frag. size              |
|--------------|------|------------------|-------------------------|-------------------------|-------------------------|------------------------------|
| 6605         | 1    | 168.9            | 19.2<br>(11.4%)         | 80.6<br>(47.7%)         | 69.1<br>(40.9%)         | 29mm: unid. long bone        |
|              | 2    | 11.9             | 0.4<br>(3.4%)           | 5.0<br>(42.0%)          | 6.5<br>(54.6%)          | 13mm: unid. long bone        |
| <b>Total</b> | -    | <b>180.8</b>     | <b>19.6<br/>(10.8%)</b> | <b>85.6<br/>(47.4%)</b> | <b>75.6<br/>(41.8%)</b> | <b>29mm: unid. long bone</b> |

Table 10: Summary of fragmentation

| Skeletal Element |  |                              |  |                     |                     |                       |                      |
|------------------|--|------------------------------|--|---------------------|---------------------|-----------------------|----------------------|
| Spit             | Skull  | Axial                        | Upper Limb   | Unid. Joint Surface | Unid. Long Bone     | Unid. Other           | TOTAL                |
| 1                | Cranial vault, mandibular body, partial molar crown, tooth root fragments<br>8.6g (3.1%) | Rib fragments<br>0.4g (0.2%) | MC shaft (2-5), distal IP, distal PP, unfused IP epiphysis, Unfused MC head (2-5), radius shaft, ulna shaft<br>3.0g (1.8%) | 4.1g (2.4%)         | 14.5g (8.6%)        | 138.3g (81.9%)        | <b>168.9g</b>        |
| 2                | Right incus, tooth root<br>0.1g (0.8%)   | -                            | -  | 0.3g (2.5%)         | 0.4g (3.4%)         | 11.1g (93.3%)         | <b>11.9g</b>         |
| <b>Total</b>     | <b>8.7g (4.8%)</b>   | <b>0.4g (0.2%)</b>           | <b>3.0g (1.7%)</b>   | <b>4.4g (2.4%)</b>  | <b>14.9g (8.3%)</b> | <b>149.4g (82.6%)</b> | <b>180.8g (100%)</b> |

Key: MC = metacarpal, IP = intermediate phalanx, PP = proximal phalanx

Table 11: Summary of identified elements and bone weights per spit

## Appendix D      References

---

- Allen, T., Barclay, A., Cromarty, A. M., Anderson-Whymark, H., Parker, A., Robinson, M. and Jones, G. (2013) *Opening the wood, making the Land; The Archaeology of a Middle Thames Landscape, Mesolithic, Neolithic and Bronze Age, Vol 1*, Oxford: Oxford Archaeological Unit. Thames Valley Landscapes Monograph **38**
- Anderson-Whymark, H. (2013) the flint, in T. Allen, A. Barclay, A. M. Cromarty, H. Anderson-Whymark, A. Parker, M. Robinson and G. Jones, *Opening the wood, making the Land; The Archaeology of a Middle Thames Landscape, Mesolithic, Neolithic and Bronze Age, Vol 1*, Oxford: Oxford Archaeological Unit. Thames Valley Landscapes Monograph 38
- Bamford, H. (1985) *Briar Hill: excavation 1974-1978*, Northampton: Northampton Development Corporation. Archaeological monograph **3**
- Barrett, J. C. (1988) Pottery, in D. Bond *Excavation at the North Ring, Mucking, Essex*, East Anglian Archaeology 43, 25-37
- Bradley, P. (1999) The worked flint. In A. Barclay and C. Halpin. Eds. *Excavations at Barrow Hills, Radley, Oxfordshire*, Oxford: Oxford Archaeological Unit. Thames Valley Landscapes Monograph **11**: 211-227.
- Booth, P. (2016) Oxford Archaeology Roman pottery recording system: An introduction, unpublished
- Brown, N. (1998) Earlier Iron Age pottery, in G A Carter *Excavations at the Orsett 'Cock' Enclosure, Essex, 1976*, East Anglian Archaeology 86, 88-9
- British Geological Survey, (2019) *Geology of Britain Viewer*. Retrieved from <http://mapapps.bgs.ac.uk/geologyofbritain/home.html>
- Brudenell, M. (2016a) Late Bronze Age Pottery, in C. Evans, G. Appleby and S. Lucy, with J. Appleby and M. Brudenell *Lives in the Land. Mucking Excavations by Margret and Tom Jones, 1965-1978: Prehistoric, Context and Summary*, Oxbow Books, 158-88
- Brudenell, M. (2016b) Middle Iron Age Pottery, in C. Evans, G. Appleby and S. Lucy, with J. Appleby and M. Brudenell *Lives in the Land. Mucking Excavations by Margret and Tom Jones, 1965-1978: Prehistoric, Context and Summary*, Oxbow Books, 365-93
- Cappers, R. T. J., Bekker, R. M. and Jans, J. E. A. (2006) *Digital Seed Atlas of the Netherlands*. Groningen Archaeological Studies 4. Barkhuis Publishing, Eelde, The Netherlands.
- Carter, G. A. (1998). *Excavations at the Orsett 'Cock' Enclosure, Essex, 1976*. Essex County Council: East Anglian Archaeology 86.



- Chartered Institute for Archaeologists, (CIfAa). (2014). Standard and Guidance for Archaeological Evaluation. Retrieved from <http://archaeologists.net/sites/default/files/node-files/IfASG-Evaluation.pdf>
- Chartered Institute for Archaeologists, (CIfAb). (2014). Standard and Guidance for the Creation, Compilation, Transfer and Deposition of Archaeological Archives
- Dewey, H. and Bromehead, C. E. N. (1915) *The geology of the country around Windsor and Chertsey*, London, H.M. Stationery Office.
- Evans, C., Appleby, G., and Lucy, S. (2016). *Lines in the Land: Mucking Excavations by Margaret and Tom Jones, 1965-1978. Prehistory: context and summary*. Cambridge Archaeological Unit Archives Series: Historiography and Fieldwork 2/Mucking 6.
- Going, C. J. (1987) *The Mansio and other sites in the south-eastern sector of Caesaromagus: the Roman pottery* CBA Research Report No 62
- Harding, P. (1990) The worked flint, in *The Stonehenge environs project*, (ed J C Richards) London, English Heritage
- Healy, F. (1988) *The Anglo-Saxon Cemetery at Spong Hil, North Elmham, Part VI: Occupation during the seventh to second Millennia BC*, East Anglian Archaeological reports 38
- Hedges, J. and Buckley, D. (1978) Excavations at a Neolithic Causewayed Enclosure, Orsett, Essex, 1975, *Proceedings of the Prehistoric Society* 44, 219-308
- Highways England, (2018) Lower Thames Crossing: A Scheme Wide Specification for Archaeological Trial Trenching: unpublished document HE540039-CJV-GEN-GEN-SPE-HER-00001draft, Revision 1.05
- Historic England, (2011) *Environmental Archaeology. A guide to the theory and practice of methods, from sampling and recovery to post-excavation* (2nd edition). Centre for Archaeology guidelines.
- Historic England, (2015) *Management of Research Projects in the Historic Environment: The MoRPHE Project Managers' Guide*. Swindon: Centre for Archaeology Guidelines
- Historic England, (2019) *Heritage at Risk: East of England Register 2019*
- Inizan, M.-L., Reduron-Ballinger, M., Roche, H. and Tixier, J. (1999) *Technology and terminology of knapped stone*, Cercle de Recherches et d'Etudes Préhistoriques, CNRS, Nanterre
- Jacomet, S. (2006) *Identification of cereal remains from archaeological sites (2nd edition)*. Archaeobotany Lab, IPAS, Basel University.
- Kemble, J. (2009) *The Place-Names of Orsett Parish and Orsett Hamlet (Crondon in Stock)*, Essex Place-names Project (Essex Society for Archaeology & History)

Essex Record Office, 2009 (e-book)  
www.essex.ac.uk/history/esah/essexplacenames

- Lucy, S. and Evans, C. (2016) *Romano-British Settlement and Cemeteries at Mucking: Excavations by Margaret and Tom Jones, 1965–1978*
- Medlycott, M (ed.) (2011) *Research and Archaeology Revisited: a Revised Framework for the East of England*. East Anglian Archaeology Occasional Paper 24: Association of Local Government Archaeological Officers
- Onhuma, K. and Bergman, C. A. (1982) Experimental studies in the determination of flake mode, *Bulletin of the Institute of Archaeology, London* **19**, 161-171
- Oxford Archaeology, (2019a) Lower Thames Crossing, Scheme-wide Written Scheme of Investigation for Trial Trenching south of the River Thames
- Oxford Archaeology, (2019b) Lower Thames Crossing, Scheme-wide Written Scheme of Investigation for Trial Trenching south of the River Thames
- Oxford Archaeology, (2019c) Lower Thames Crossing. Written Scheme of Investigation for Archaeological Trial Trenching. Scheduled Monument Cropmark Complex, Orsett, Thurrock, unpublished document HE540039-CJV-GEN-GEN-REP-GEO-00022, Issued July 2019, revision 1.2 issued 20/08/19
- Place Services, (2019) Lower Thames Crossing Aerial Investigation and Mapping Report, Essex County Council
- PCRG, SGRP, MPRG, (2016) A standard for pottery studies in archaeology, Prehistoric Ceramics Research Group, Study Group for Roman Pottery, and the Medieval Pottery Research Group
- Tomber, R. and Dore, J. (1998) The National Roman Fabric Reference Collection
- Stace, C 2010 *New Flora of the British Isles*, 3rd Edition. Cambridge: CUP
- Wilkinson, T. J. with Carney, T. M. (1980) Thurrock A13/M25 Road Schemes. *Essex Archaeology & History* **12**, 48
- Wilkinson, T. J. (1988) *Archaeology and Environment in South Essex: Rescue Archaeology on the route of the A13 Grays By-pass, 1979/80*. East Anglian Archaeology **42**
- Young, C. J. (1977) *The Roman pottery industry of the Oxford region*, BAR BS 43

## Appendix E      Abbreviations and Glossary

---

**ADS** Archaeology Data Service. Digital archaeological archive

**CDM** Construction Design Manual. Health and safety guidance for the construction industry

**CPD** Continuing Professional Development

**CIfA** Chartered Institute for Archaeologists

**DBA** Desk Based Assessment. Detailed assessment of archaeology and other aspects of the historic environment

**DCO** Development Consent Order

**EIA** Environmental Impact Assessment. Detailed study of environmental impacts as directed under the The Town and Country Planning (Environmental Impact Assessment) Regulations 2017 following on from EU Directive EIA Directive (85/337/EEC)

**ES** Environmental Statement. The principal environmental report detailing environmental impacts within an EIA

**GPS** Global Positioning System

**HER** Historic Environment Record

**LTC** Lower Thames Crossing

**MCIfA** Member of the Chartered Institute for Archaeologists

**MoRPHE** Management of Research Projects in the Historic Environment

**NMP** National Mapping Programme. A study of aerial photographs and digitisation of resulting data into GIS. Originally funded by Historic England

**OASIS** Online Access to the Index of archaeological investigations.  
The OASIS project brings together a number of strategic partners: the Archaeology Data Service, Historic England, Historic Environment Scotland, and the Royal Commission on the Ancient and Historical Monuments of Wales under the umbrella of the University of York

**OCN** Old County Number. Historic England's reference for material that is not readily-available online and may represent historic archaeological work that consists of paper archives or has yet to be formally reported on

**PINS** Planning Inspectorate

**RAMS** Risk Assessment Method Statement

**SMC** Scheduled monument consent

**TDR** Trusted Digital Repository

**UKIC** United Kingdom Institute for Conservation

**WSI** Written Project of Investigation. A detailed method statement for archaeological work

**WSL** – Western Southern Link  
The Western Southern Link (WSL) is an alternative for Short List Routes 2, 3 and 4 to the south of the River Thames.

## Appendix F Site Summary

---

|                             |   |
|-----------------------------|---|
| <b>Site name:</b>           | Lower Thames Crossing Land Parcel 22/23<br>Whitfield South, South of Stifford Clays Road, Baker Street –<br>Scheduled Monument  |
| <b>Site code:</b>           | LTC22S19  |
| <b>Grid Reference</b>       | TQ 62910 81217  |
| <b>Type:</b>                | Evaluation  |
| <b>Date and duration:</b>   | 15th January – 3rd February 2020  |
| <b>Area of Site</b>         | 15.11ha   |
| <b>Location of archive:</b> | The archive from Land Parcel 22/23 will form part of the overall trial trenching scheme archive. This will be deposited in a repository consistent with the standards required by the Museums and Galleries Commission following completion of the archaeological phase of this project. This may either be with the local receiving museum in Thurrock or, if no such repositories are available, with a repository for the whole project designated by LTC. LTC retain the overall responsibility for the successful deposition of the project archive. |

Currently, the archive is held at Oxford Archaeology's head office, Janus House, Osney Mead, Oxford, Oxfordshire, OX2 0ES. Oxford Archaeology will store the archive for LTC for a maximum period of 2 years following the completion of the project. If the storage of the archive at OA's office extends past this period, an extension to the storage period and final deposition timetable will be reviewed by OA and LTC and agreed with the major stakeholders.

### **Summary of Results:**

Oxford Cotswold Archaeology was commissioned by Balfour Beatty to undertake a trial trench evaluation of Land Parcel 22/23 of the Lower Thames Crossing Pre-Enabling Works. Land Parcels 22/23, also known as Whitfield South – Scheduled Monument, is situated c 70m west of the hamlet of Baker Street and 0.9km west of the village of Orsett within the county of Essex and Thurrock unitary authority (NGR TQ 62910 81217). The evaluation comprised 76 trenches and was completed between the 15th January and 3rd February 2020.

The fieldwork revealed some evidence for Late Bronze Age to Early Iron Age activity within the site, including the remains of a mostly complete but poorly preserved vessel.

A second phase of activity was encountered in the northern portion of the site, along Stifford Clays Road. This comprised several phases of Late Iron Age to Early Roman field systems including enclosures, field boundaries and/or possible trackways, hinting at extensive agricultural exploitation of the area for an extended period of time.

Evidence for more recent exploitation of the site was encountered in the form of a number of modern ceramic field drains which were observed to cut the tops of several enclosure ditches, as well as extensive root damage and some plough scarring in the top of the natural geology. It is also possible that Trenches 17, 23 and 30 revealed the poorly preserved line of a field boundary marked on the 1st Edition Ordnance Survey map.

A number of undated features were also investigated, it is possible that some of these relate to the Iron Age/Romano-British transitional activity within the area. Alternatively, some of the features may belong to the earlier phase of activity within the site, with some potential that some of the curvilinear and ring-ditches may represent the plough-damaged remains of Bronze Age features.

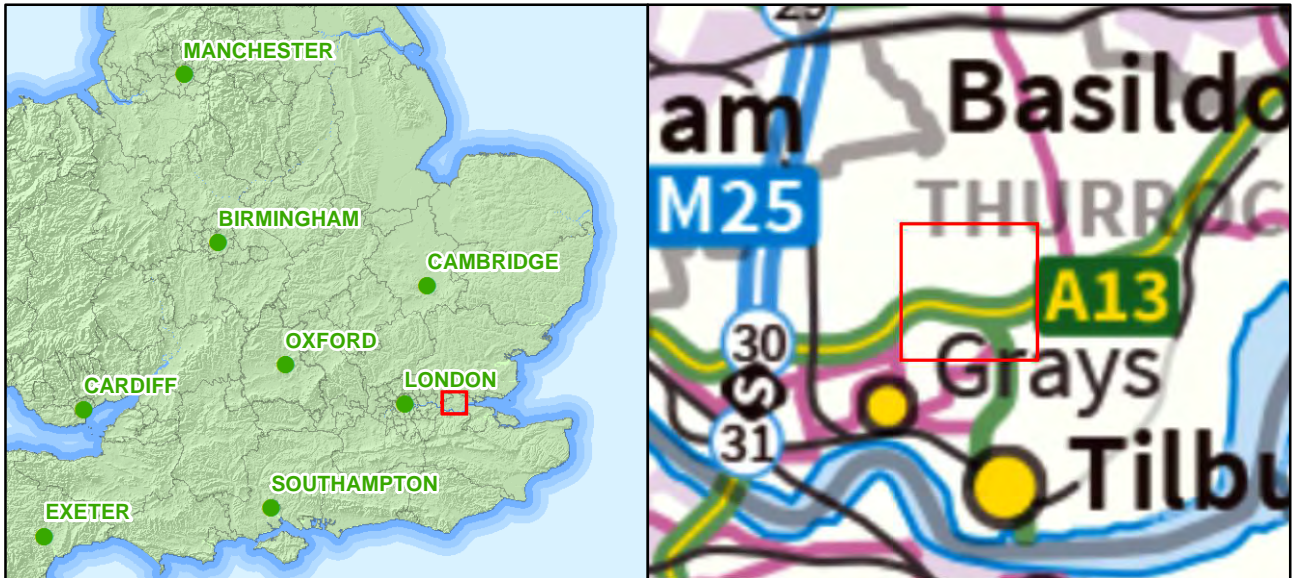

X:\WIL\TOEV\_Lower\_Thames\_Crossing\010\Geomatics\03 GIS Projects - L\TC22S19\Figures\TC22\Figure 1.mxd\aidan.farman\26/02/2020

Source: Esri, DigitalGlobe, GeoEye, Earthstar Geographics, CNES/Airbus DS, USDA, USGS, AeroGRID, IGN, and the GIS User Community

Figure 1: Map showing the location of Land Parcel 22

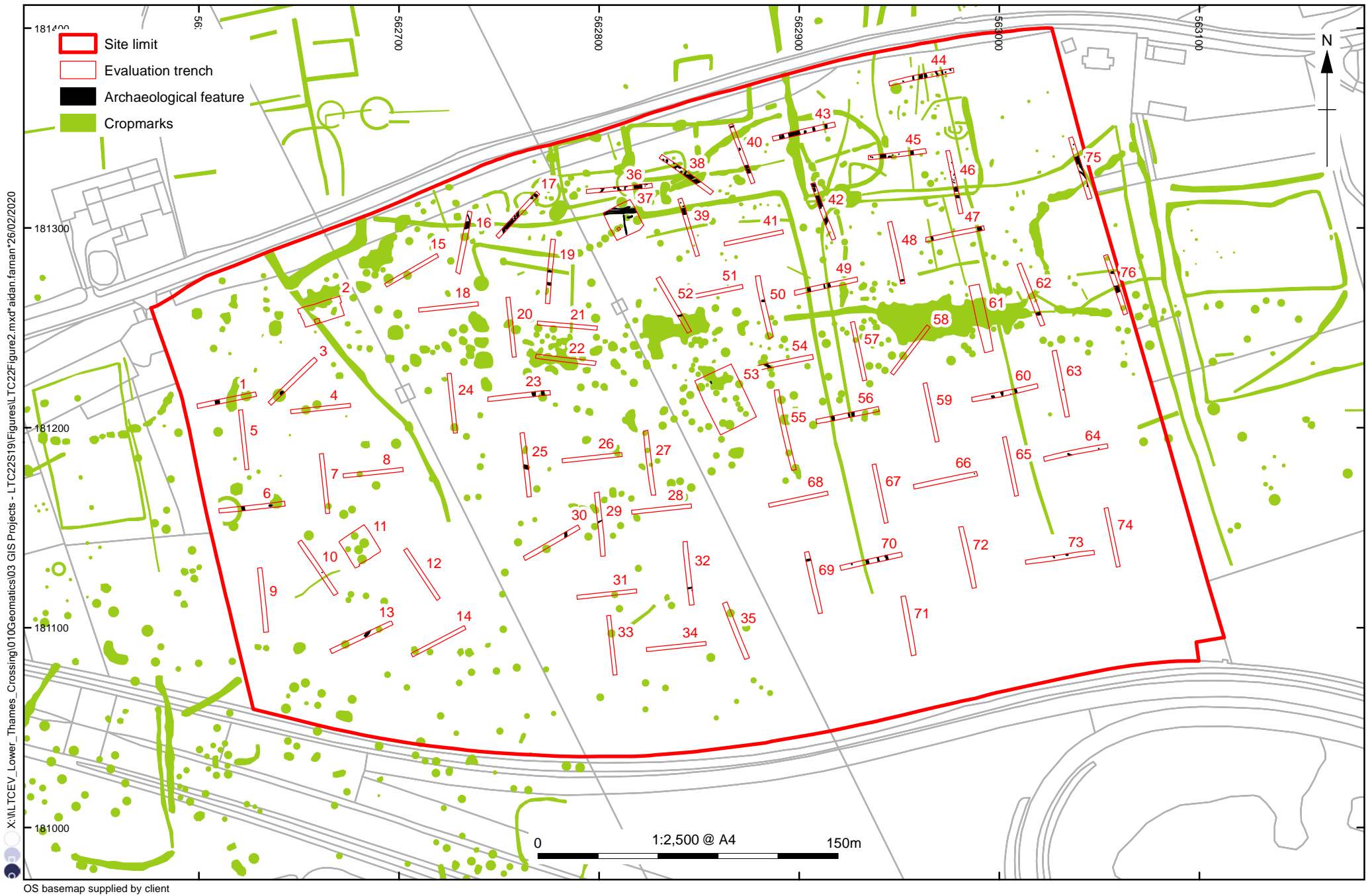
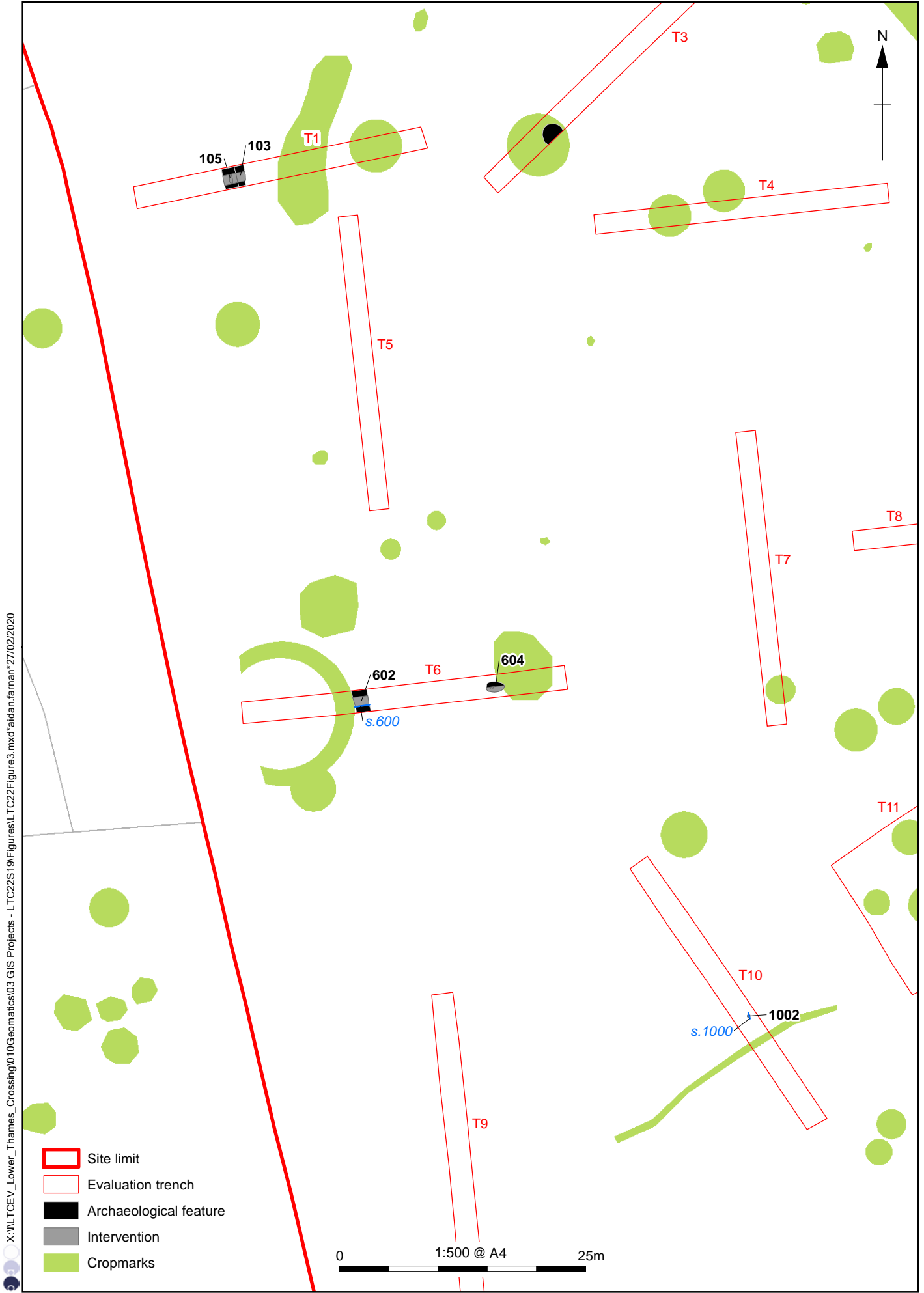

Figure 2: Plan of trench layouts, cropmark features and archaeological features



X:\WIL\TOEV\_Lower\_Thames\_Crossing\010\Geomatics\03 GIS Projects - L\TC22S19\Figures\TC22\Figure3.mxd\aidan.farman 27/02/2020

OS basemap supplied by client

Figure 3: Plan of Trenches 1, 6 and 10



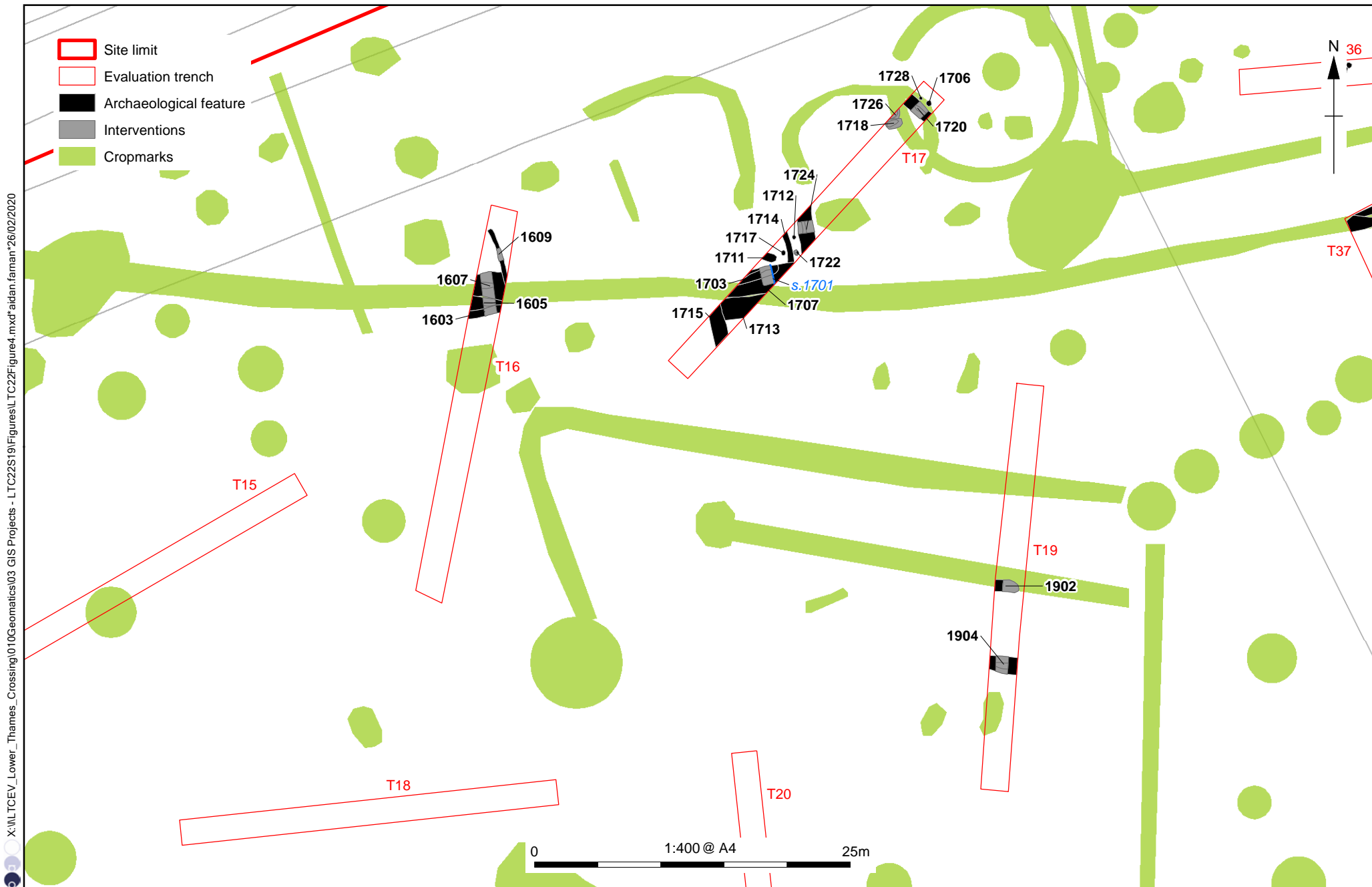

OS basemap supplied by client

Figure 4: Plan of Trenches 16, 17 and 19

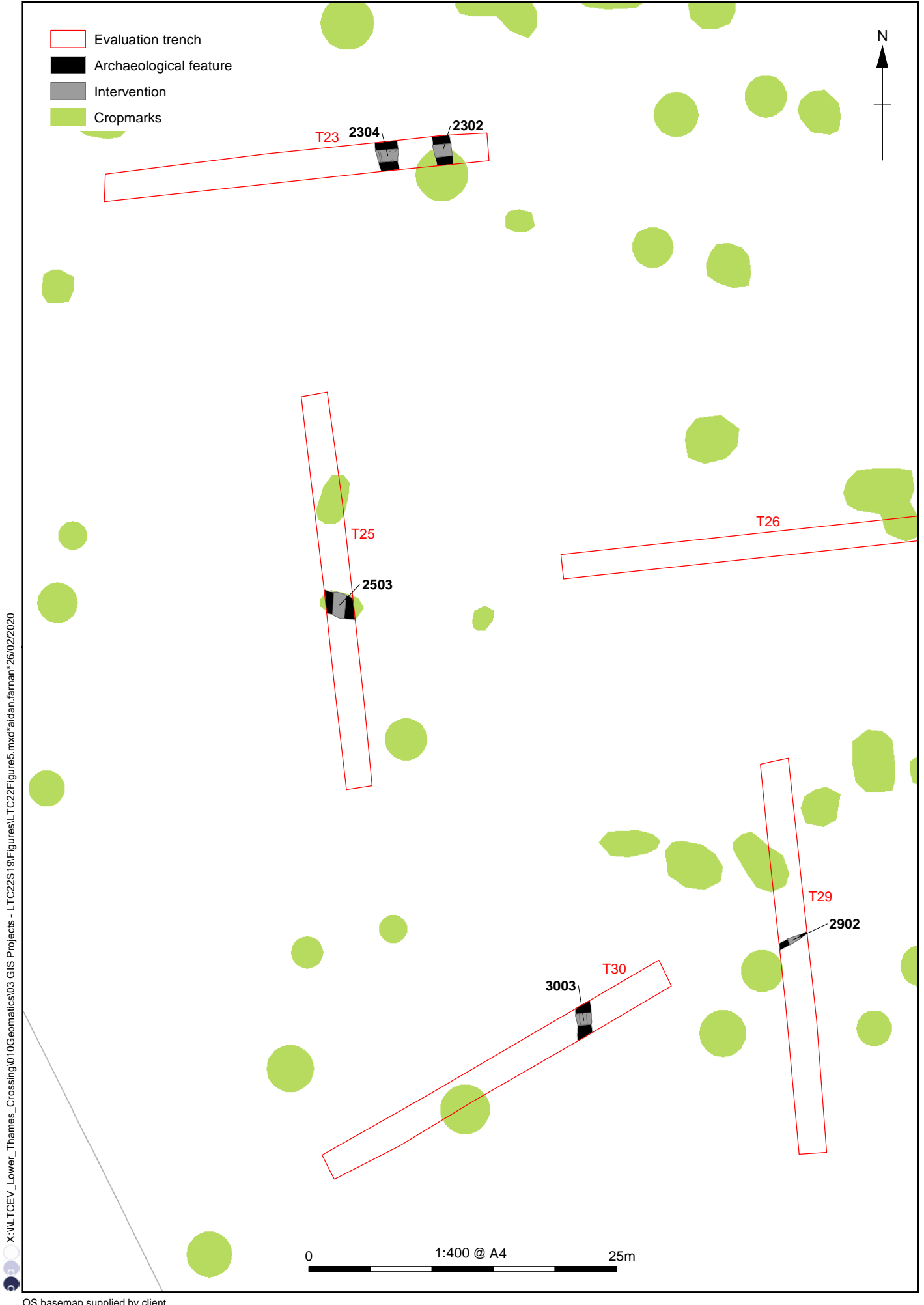
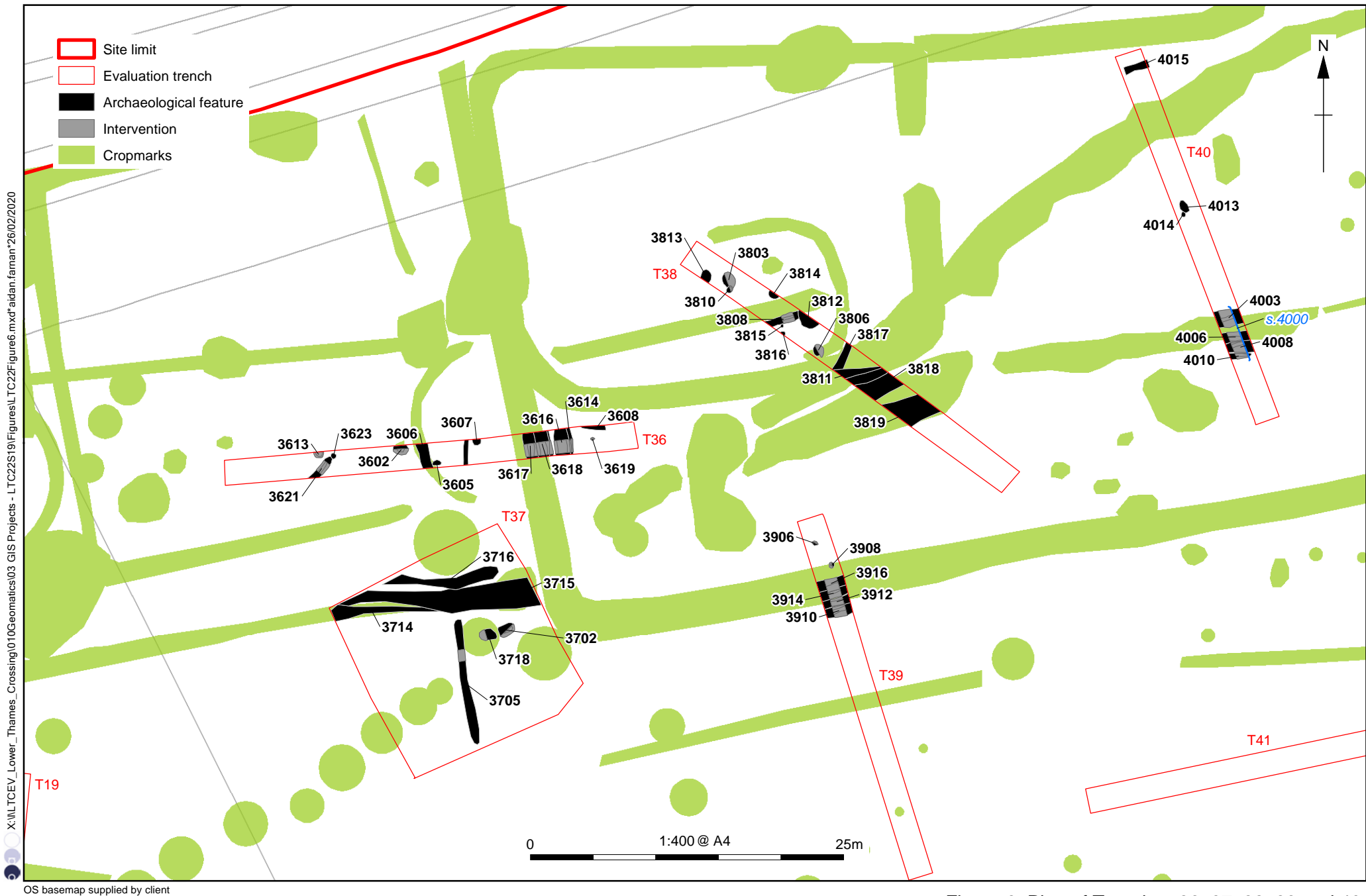

Figure 5: Plan of Trenches 23, 25, 30 and 32



OS basemap supplied by client

Figure 6: Plan of Trenches 36, 37, 38, 39 and 40

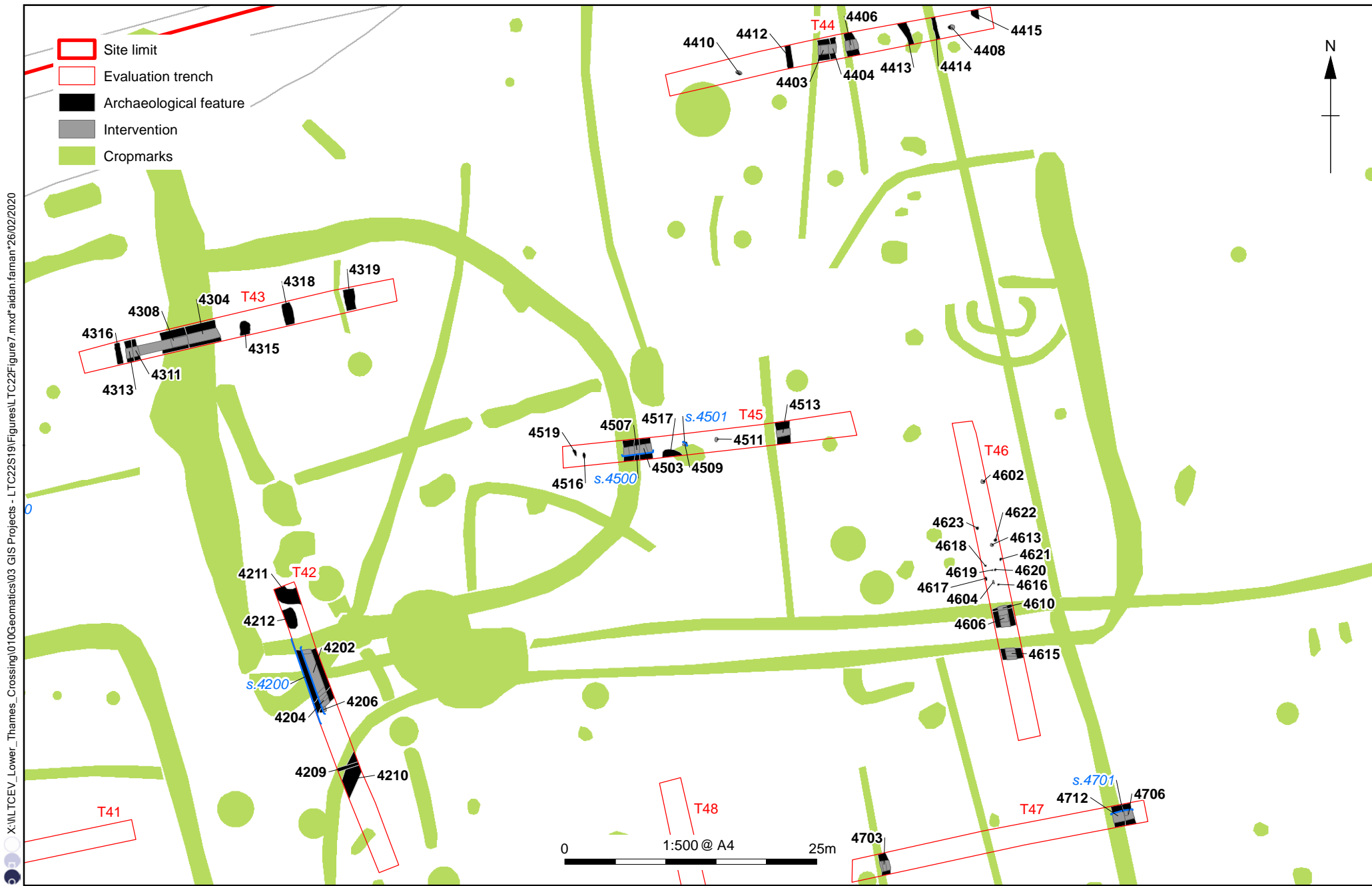

Figure 7: Plan of Trenches 42, 43, 44, 45 and 46

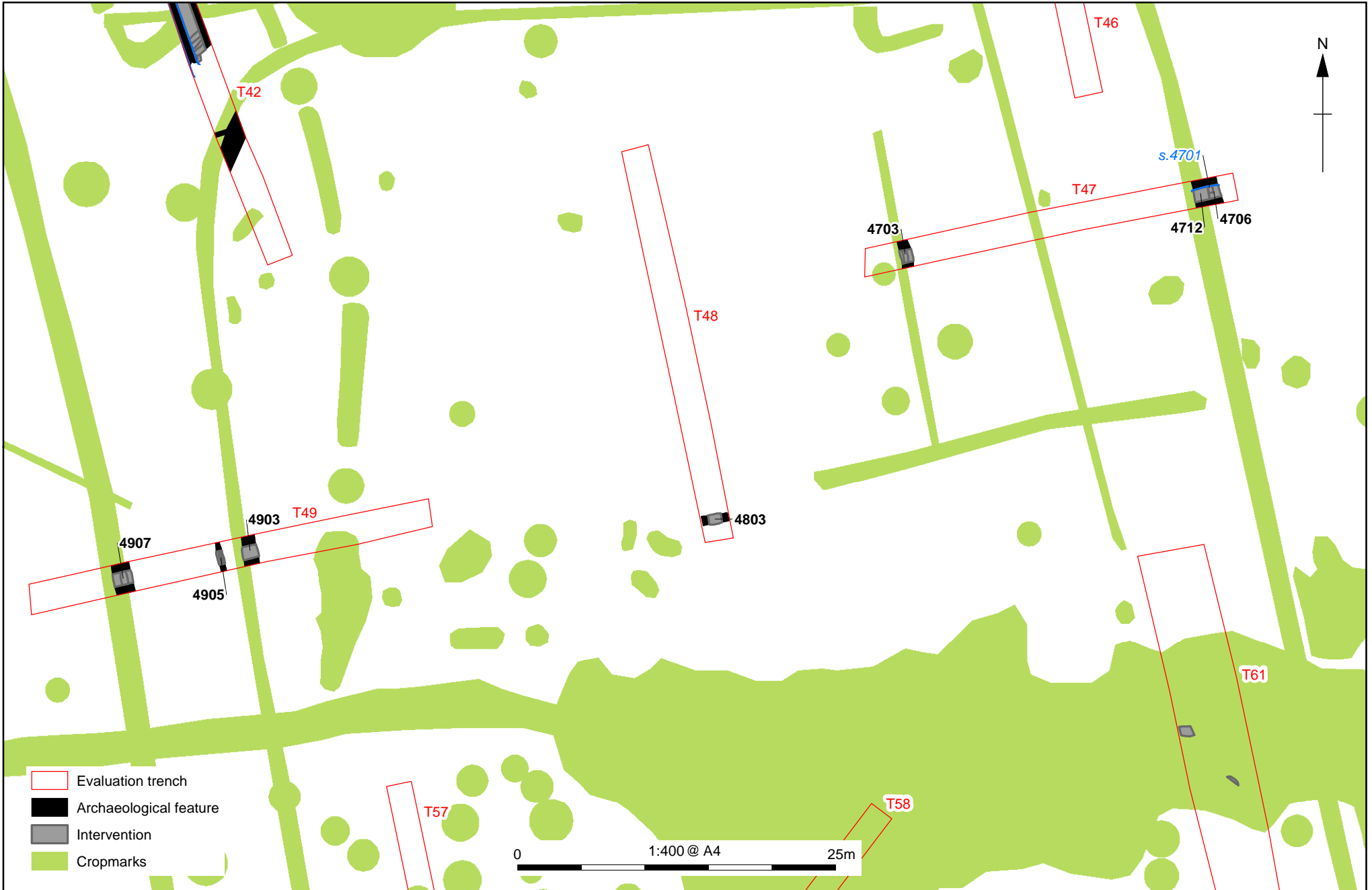
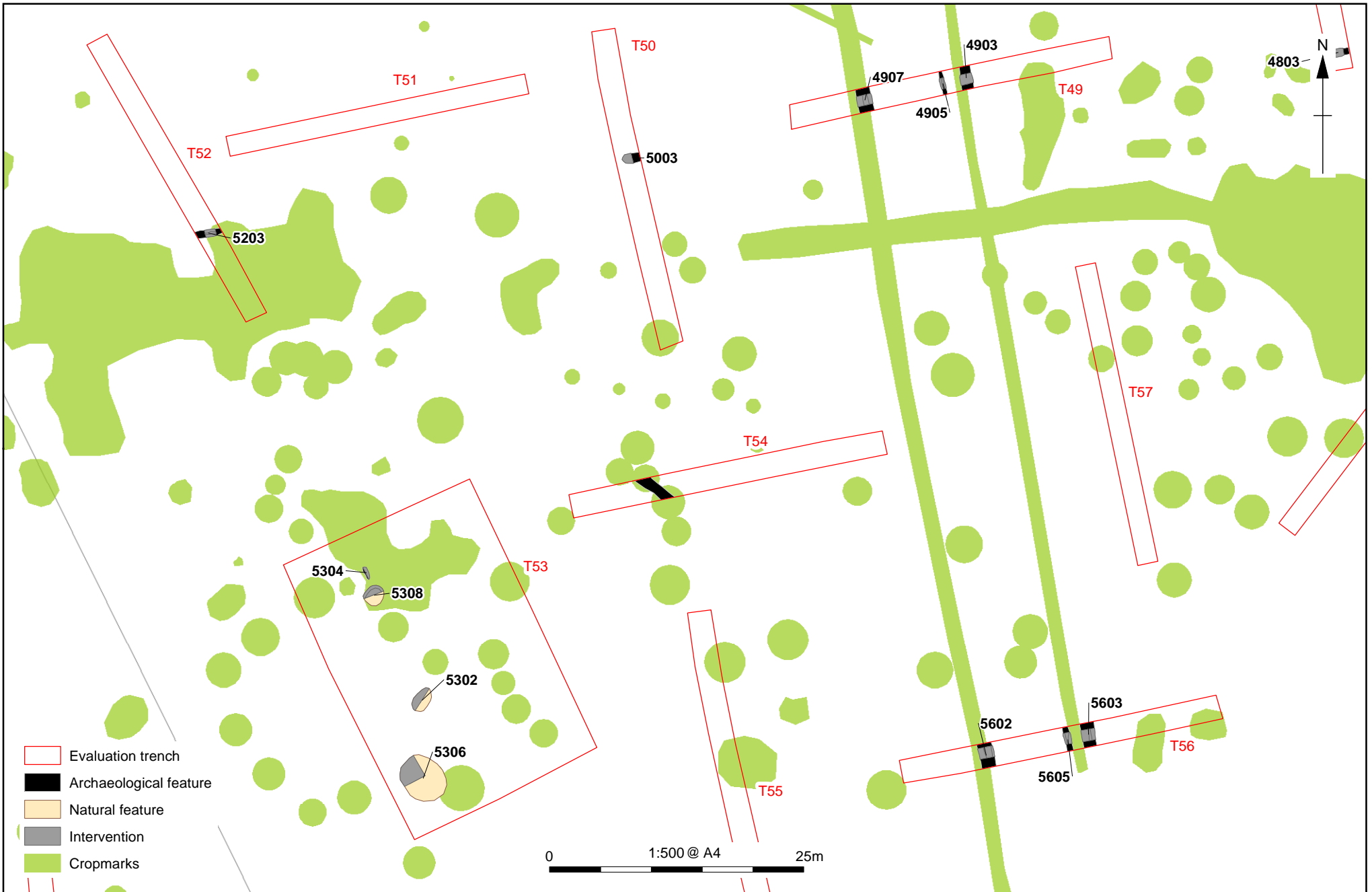

Figure 8: Plan of Trenches 47, 48 and 49

X:\MLTCEV\_Lower\_Thames\_Crossing\010Geomatics\03 GIS Projects - LTC22S19\Figures\LTC22\Figure9.mxd\aidan.faman\27/02/2020



OS basemap supplied by client

Figure 9: Plan of Trenches 50, 52, 53 and 56

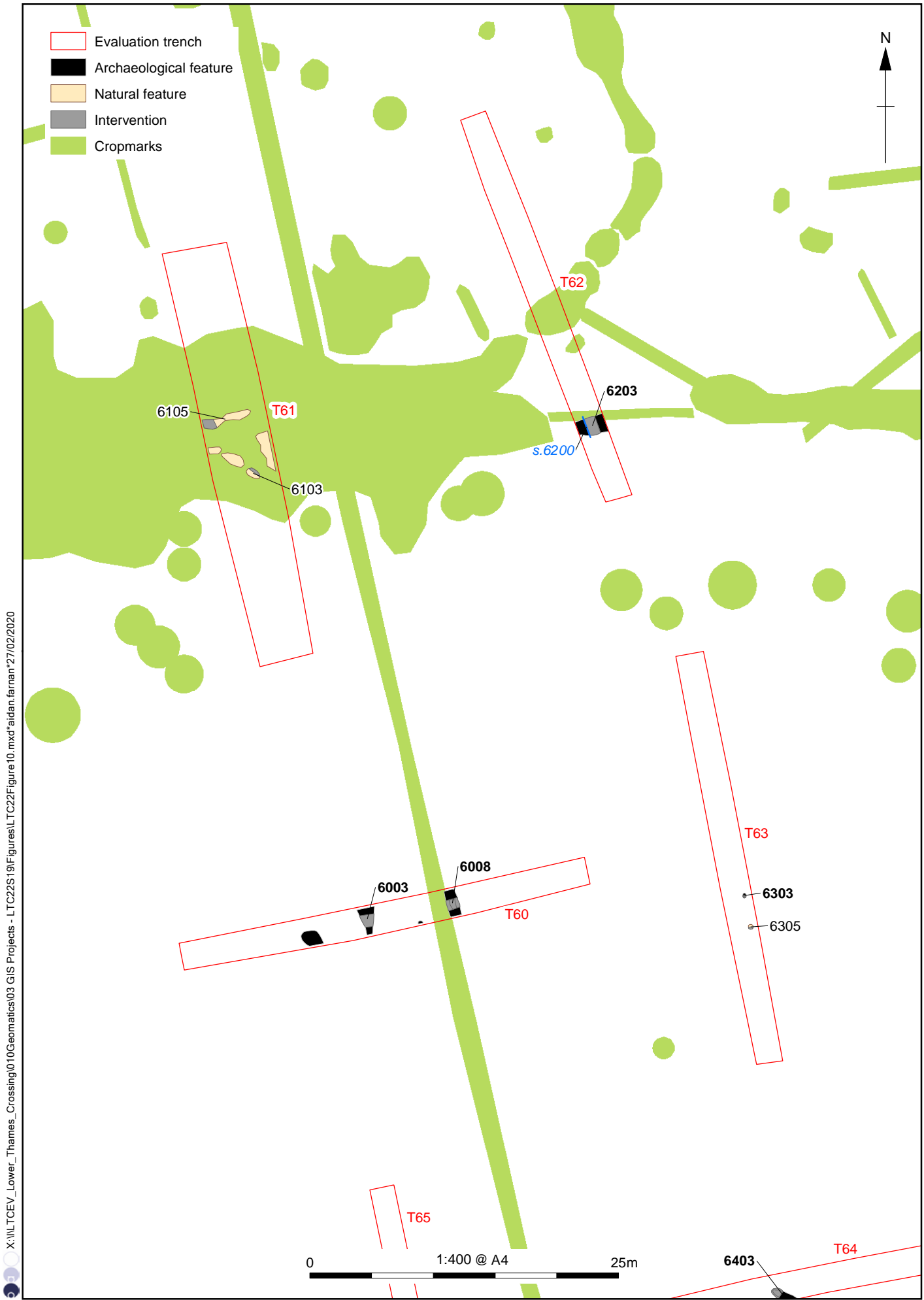

Figure 10: Plan of Trenches 60, 62 and 63

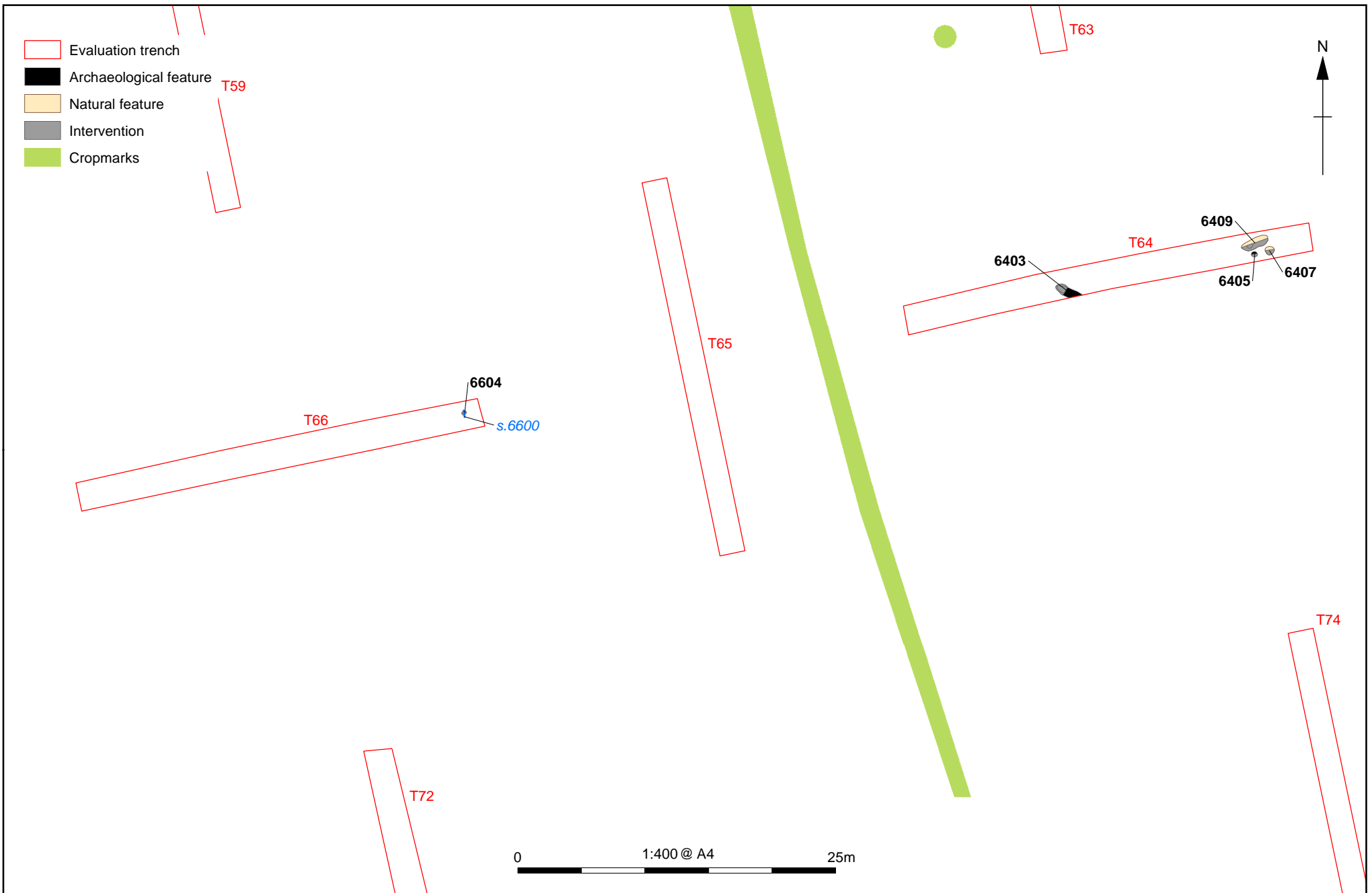
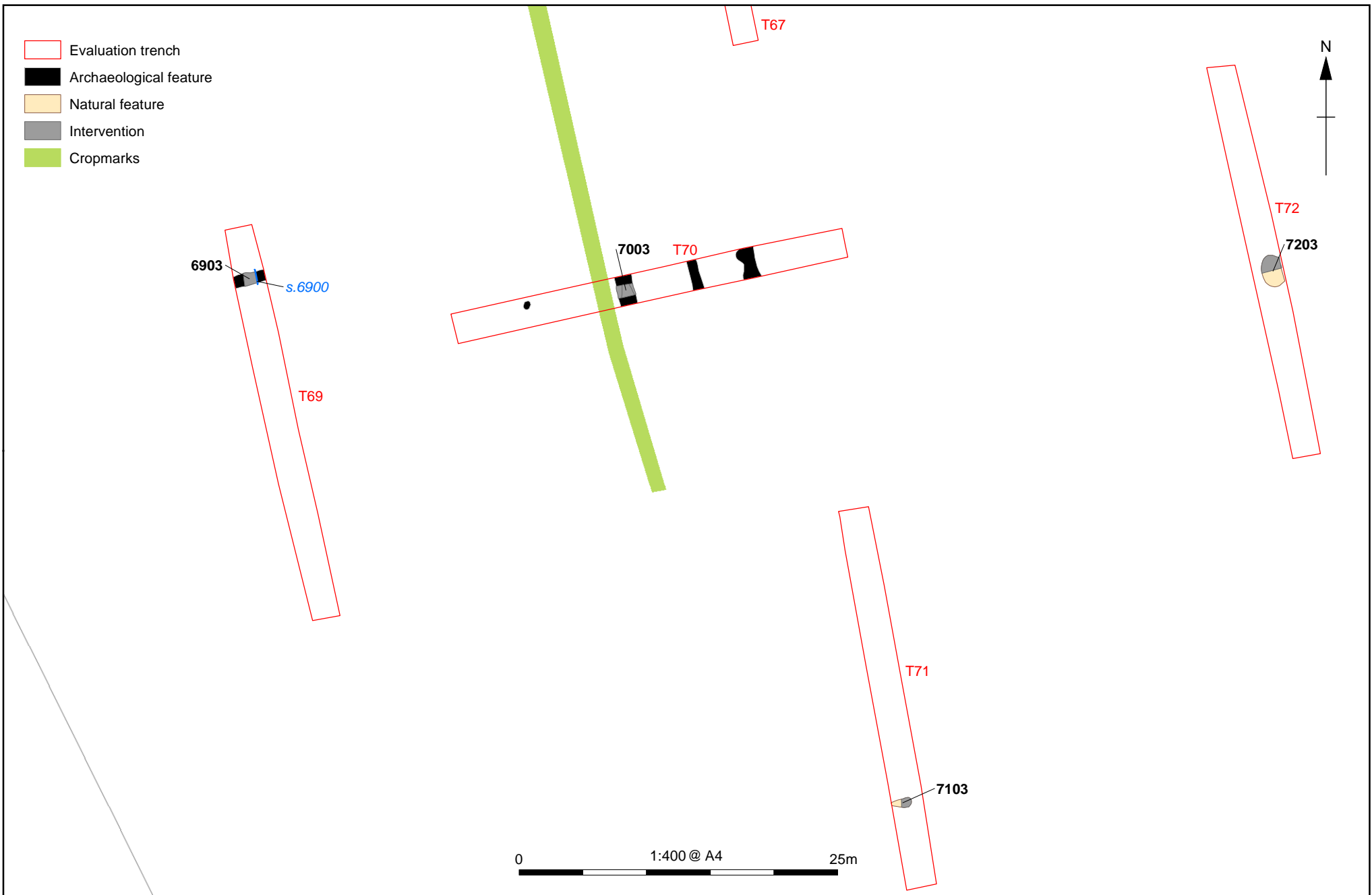

Figure 11: Plan of Trenches 64 and 66



X:\MLTCEV\_Lower\_Thames\_Crossing\010Geomatics\03 GIS Projects - LTC22S19\Figures\LTC22Figure 12.mxd\*aidan.farnan\*27/02/2020



OS basemap supplied by client

Figure 12: Plan of Trenches 69 and 70

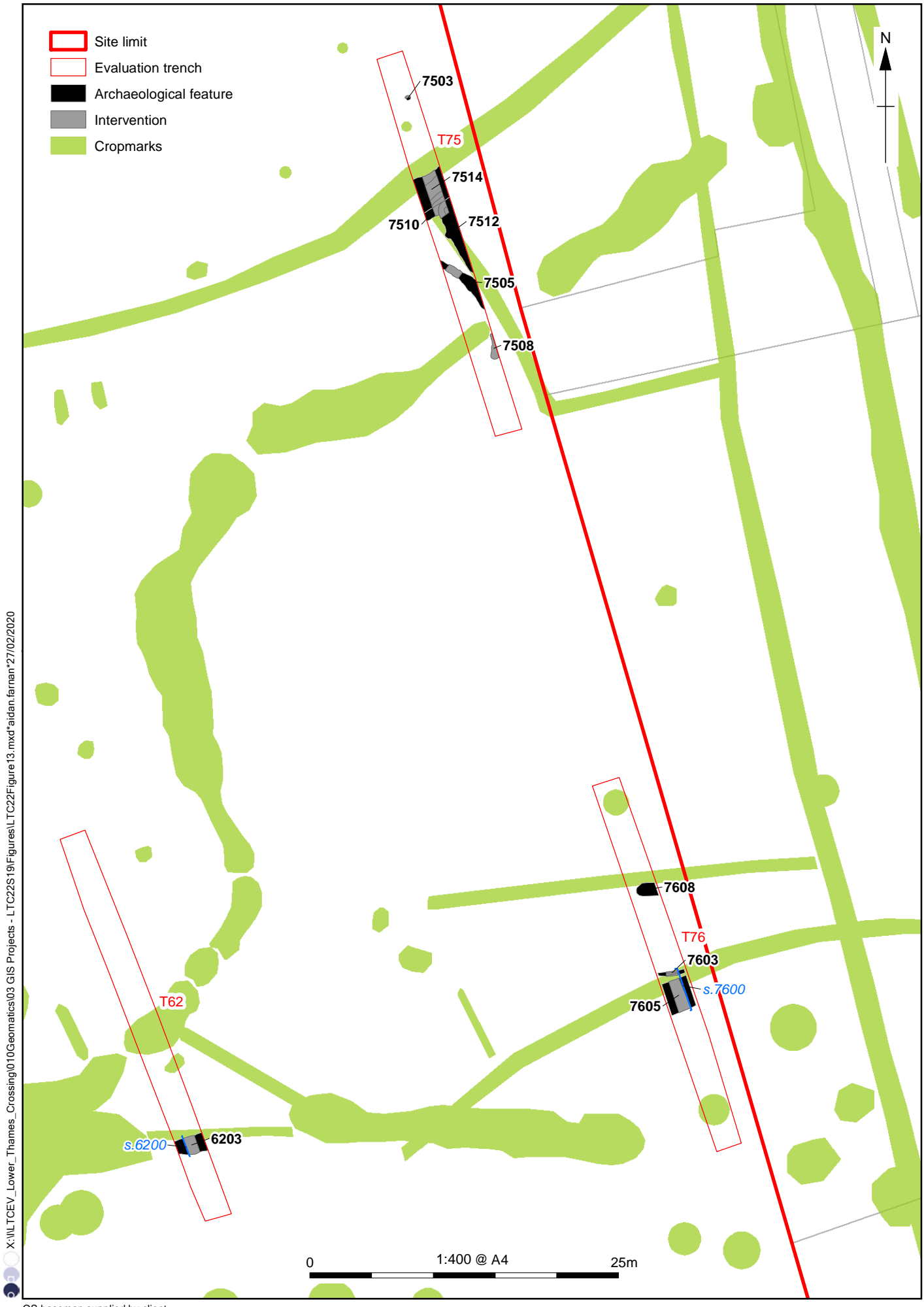

X:\11\TCEV\_Lower\_Thames\_Crossing\010\Geomatics\03 GIS Projects - L\TC22S19\Figures\LT22\Figure 13.mxd\aidan.farnan\*27/02/2020

OS basemap supplied by client

Figure 13: Plan of Trenches 75 and 76

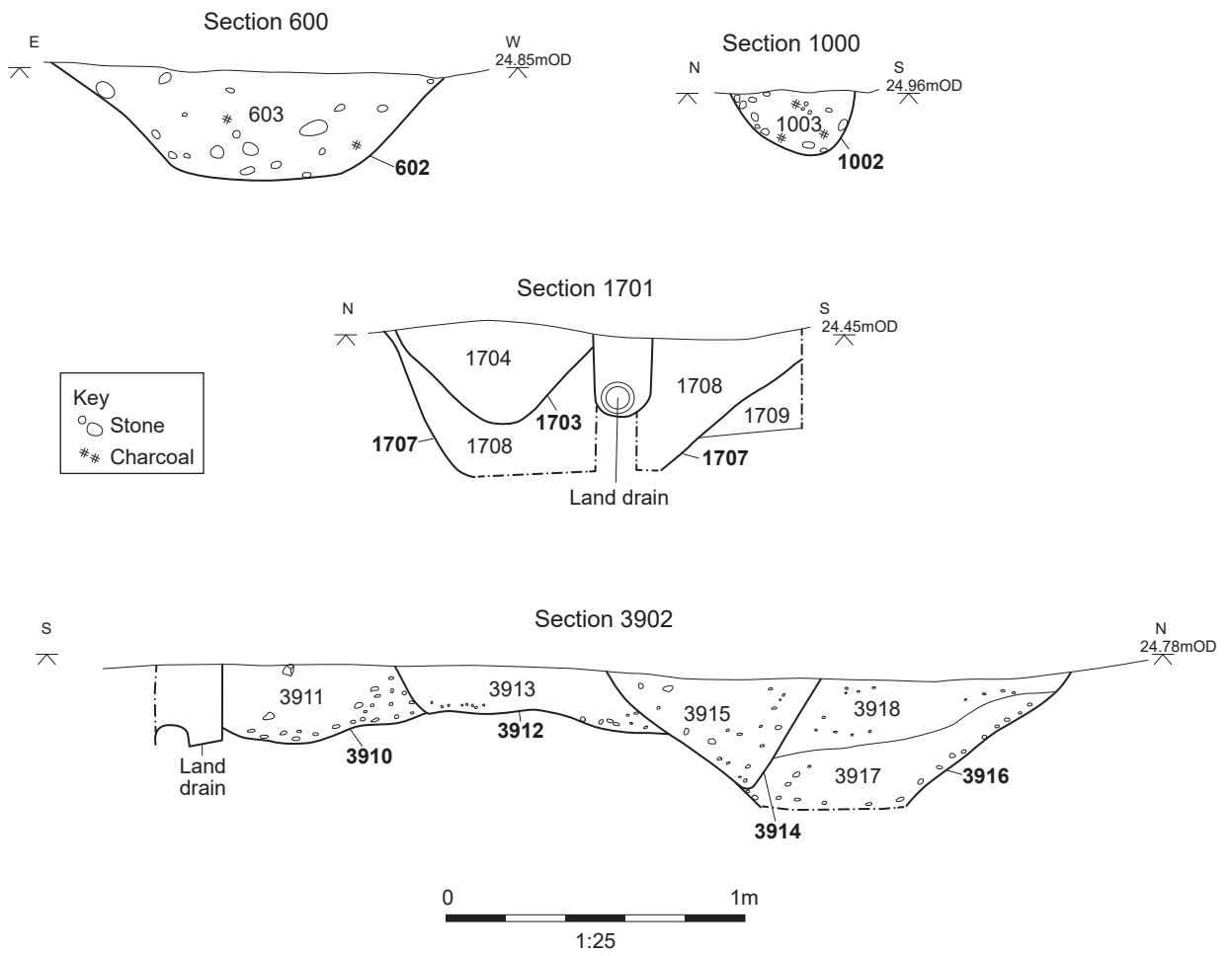

Figure 14: Sections (Trenches 6, 10, 17 and 39)

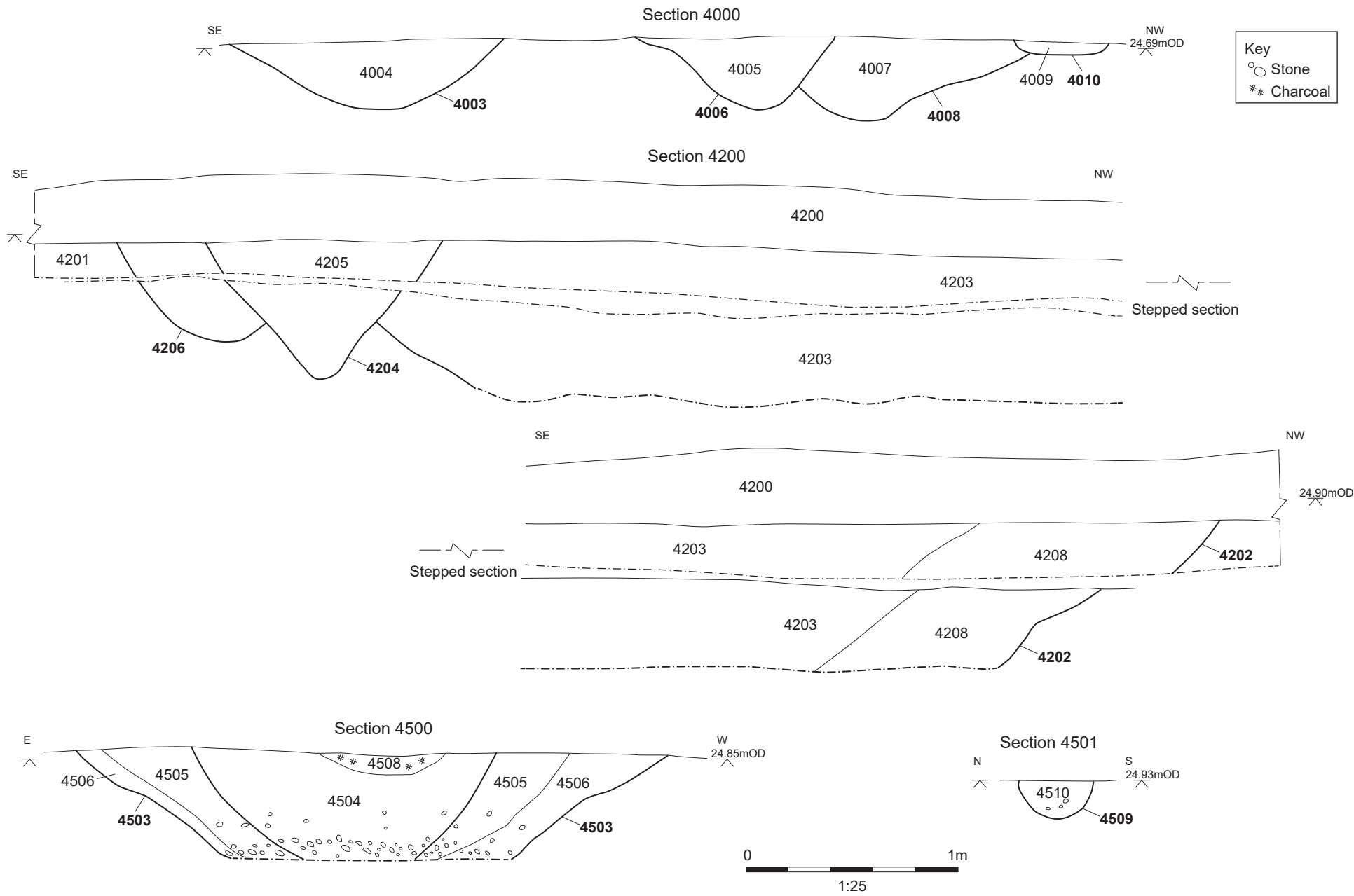

Figure 15: Sections (Trenches 40, 42 and 45)

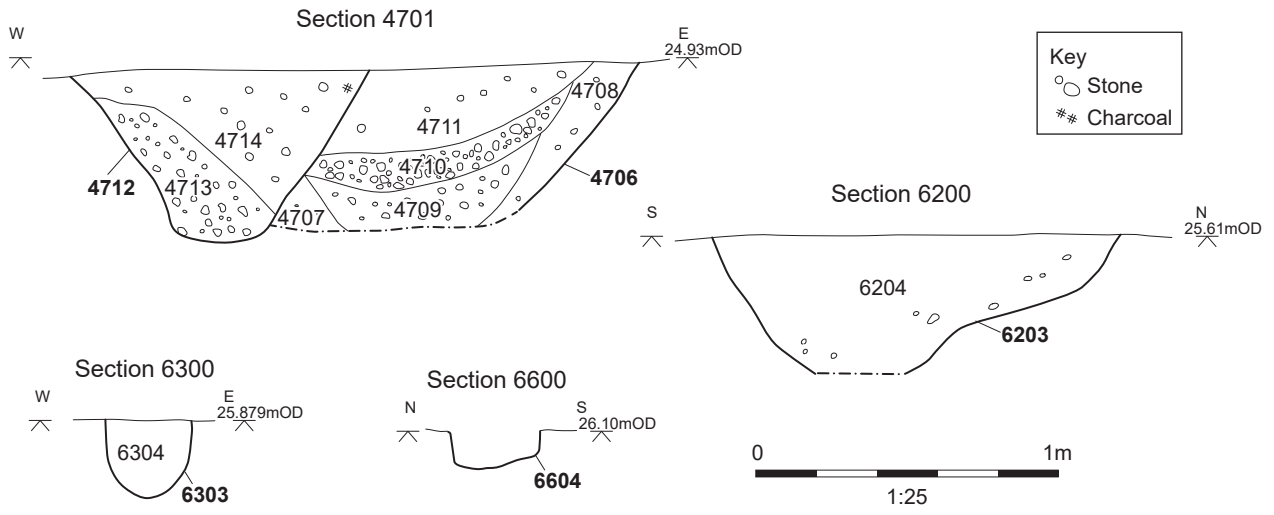

Figure 16: Sections (Trenches 47, 62, 63 and 66)

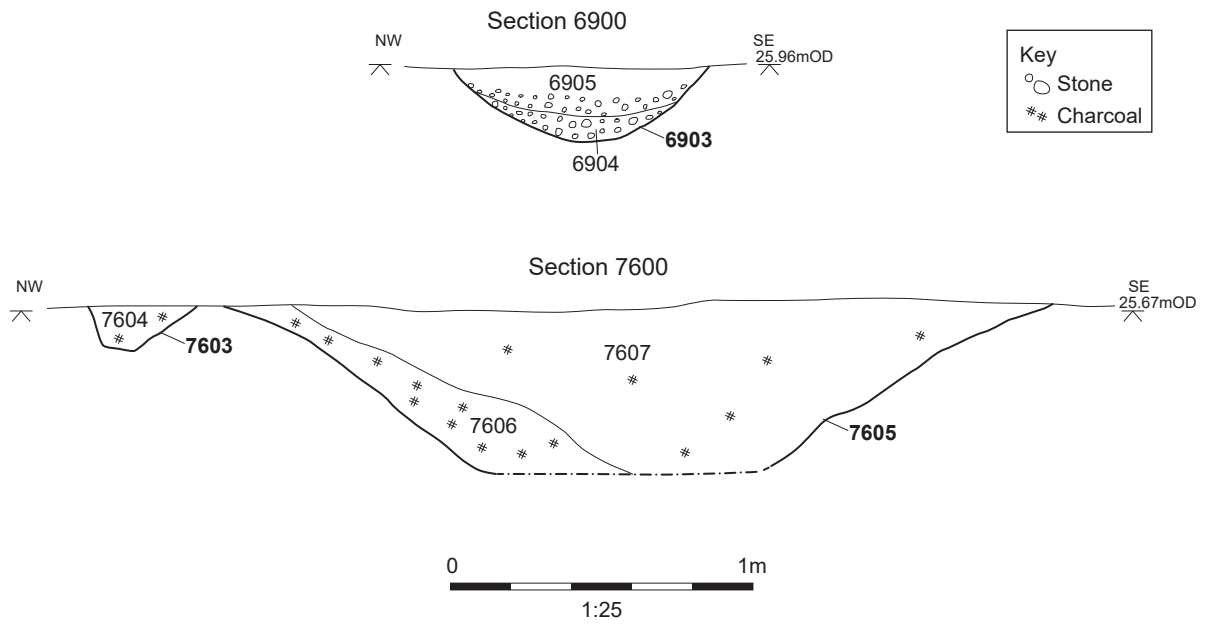

Figure 17: Sections (Trenches 69 and 76)



Plate 1: Ring-ditch 602, facing south



Plate 2: Pit 1002, facing east



Plate 3: Ditch 1703, looking south-west



Plate 4: Overview of ditches 4406, 4404, and 4403, facing south





oxford technology  
10.0.10.86\invoice codes i thru q\L\_codes\LTC\_Lower Thames Crossing\22\_LTC25EV\_Whitfield\_south\*1.G\*26.02.20

Plate 5: Cremation pit 6603



Plate 6: Overview of ditches 7510, 7512, and 7514, facing north-east

## COVER SHEET

|                      |   |
|----------------------|---|
| <b>Title:</b>        | <b>Archaeological Evaluation Report for Trial Trenching of Land Parcels 3 (North), 30, 31, 35, 103, 104 and 107 Land Bordering the A13 at Orsett, Essex</b> |
| <b>Project Name:</b> | <b>Lower Thames Crossing Enabling Works</b>   |
| <b>Ref No:</b>       | <b>HE540039-BAL-GEN-GEN-REP-HER-00032</b>   |
| <b>Revision No:</b>  | <b>P02</b>  |
| <b>Review Date:</b>  | <b>08/12/2021</b>   |
| <b>Status:</b>       | <b>S2 – For Information</b>   |
| <b>No. of Pages</b>  | <b>319</b>  |

| <b>Rev</b> | <b>Date of Issue</b> | <b>Revision Status</b> | <b>Originator</b> | <b>Checker</b> | <b>Approver</b> |
|------------|----------------------|------------------------|-------------------|----------------|-----------------|
| P01        | 02/02/2021           | S2                     | Sam Ashton        | Jack Fletcher  | Emily Erswell   |
| P02        | 08/12/2021           | S2                     | Conal Mundy       | Jack Fletcher  | Emily Erswell   |
|            |                      |                        |                   |                |                 |



# Lower Thames Crossing

Archaeological Evaluation Report for Trial Trenching of  
Land Parcels 3 (North), 30, 31, 35, 103, 104 and 107  
Land Bordering the A13 at Orsett, Essex

Document Number: HE540039-BAL-GEN-GEN-REP-HER-00032

**December 2021**



| <b>Revision</b> | <b>Production Date</b> | <b>Prepared by</b>   | <b>Checked by</b>  | <b>Approved for release by</b> | <b>Sections revised</b>  |
|-----------------|------------------------|--|--|--------------------------------|--|
| 1.0             | 27th January 2021      | Mark Dodd<br>Project Officer<br>Oxford Archaeology   | Andrew Simmonds<br>Senior Project Manager (PX)<br>Oxford Archaeology             | Internal review only           |  |
| 1.1             | 1st February 2021      | Mark Dodd<br>Project Officer<br>Oxford Archaeology   | Steve Lawrence<br>Senior Project Manager<br>Oxford Archaeology                   |                                |  |
| 2.1             | 2nd December 2021      | Rebecca Nicholson<br>Environmental Manager, and<br>Kate Brady<br>Project Officer<br>Oxford Archaeology | Tim Allen and<br>Steve Lawrence<br>Senior Project Managers<br>Oxford Archaeology |                                | Summary<br>1.1.4, 1.2,<br>Section 3,<br>4.6, 4.12,<br>4.24-30.<br>Section 5<br>Appendices A,<br>B, C, D and F<br>Figures and<br>plates added |
|                 |                        |  |  |                                |  |

This Evaluation Report has been prepared for Highways England in accordance with the terms and conditions of appointment stated in the Lower Thames Crossing (LTC) Technical Partner Contract. LTC cannot accept any responsibility for any use of or reliance on the contents of this document by any third party.

# Contents

| Section   | Page      |
|---|-----------|
| <b>Summary</b> .....  | <b>9</b>  |
| <b>Acknowledgements</b> .....                                   | <b>11</b> |
| <b>1 Introduction</b> .....                                     | <b>12</b> |
| 1.1 Project details and scope of work .....                     | 12        |
| 1.2 Location, topography and geology .....                      | 13        |
| 1.3 Previous investigations .....                               | 14        |
| 1.4 Archaeological and historical background.....               | 14        |
| <b>2 Project Aims</b> .....                                     | <b>23</b> |
| 2.1 General aims .....  | 23        |
| 2.2 Specific objectives .....                                   | 24        |
| <b>3 Methodology</b> .....                                      | <b>26</b> |
| 3.1 Constraints.....  | 26        |
| 3.2 Methodology for the evaluation .....                        | 26        |
| <b>4 Results</b> .....  | <b>28</b> |
| 4.1 Introduction and presentation of results .....              | 28        |
| 4.2 General soils and ground conditions.....                    | 28        |
| 4.3 General distribution of archaeological deposits .....       | 28        |
| 4.4 Trenches 146-50 (Figs 8 and 9).....                         | 29        |
| 4.5 Trenches 141-5 (Figs 10 and 11).....                        | 31        |
| 4.6 Trenches 134-7 and 139-40 (Figs 12 and 13).....             | 34        |
| 4.7 Trenches 120-2 (Figs 14 and 16).....                        | 36        |
| 4.8 Trenches 156, 165 and 192 (Figs 15 and 16) .....            | 36        |
| 4.9 Trenches 172-4 and 176 (Figs 17 and 18).....                | 36        |
| 4.10 Trenches 169-70, 177, 179 and 183-4 (Figs 19 and 20).....  | 37        |
| 4.11 Trenches 186-9 (Figs 21 and 22).....                       | 38        |
| 4.12 Trenches 38, 40-9 and 51 (Figs 23 and 24).....             | 39        |
| 4.13 Trenches 54-6, 58-9 and 61-3 (Figs 25 and 26) .....        | 41        |
| 4.14 Trenches 64, 66, 69, 70 and 72-5 (Figs 27 and 28).....     | 43        |
| 4.15 Trenches 68, 71, 76, 82, 89, and 90 (Figs 29 and 30) ..... | 45        |
| 4.16 Trenches 78, 105-6 and 112-14 (Figs 31 and 32).....        | 46        |
| 4.17 Trenches 98-100 and 108 (Figs 33 and 34).....              | 47        |
| 4.18 Trenches 83-6 and 92-3 (Figs 35 and 36).....               | 48        |
| 4.19 Trenches 87-8, 95-96, 102-4 and 111 (Figs 37 and 38) ..... | 49        |
| 4.20 Trenches 1, 5-7, 14-15 and 17 (Figs 39 and 40).....        | 50        |
| 4.21 Trenches 8-11, 13 and 22 (Figs 41 and 42).....             | 52        |
| 4.22 Trenches 24-5, and 27 (Figs 43 and 44).....                | 53        |
| 4.23 Trenches 31-35 (Figs 45 and 46).....                       | 54        |
| 4.24 Trenches 195, 198, 200 and 202 (Fig. 47).....              | 55        |
| 4.25 Trenches 207-8 and 211-13 (Fig. 48) .....                  | 56        |
| 4.26 Trenches 214-17, 220-4 and 227 (Figs 49 and 50).....       | 56        |
| 4.27 Trenches 228, 230-2 and 235-7 (Fig. 51) .....              | 58        |
| 4.28 Trenches 242-248 (Figs 52 and 54).....                     | 59        |
| 4.29 Trenches 283-5 (Figs 53 and 54).....                       | 61        |

|                   |  |            |
|-------------------|--|------------|
| 4.30              | Trenches 297-8, 300 and 303 (Fig. 55)..... | 62         |
| 4.31              | Finds summary .....                        | 62         |
| 4.32              | Environmental summary .....                | 63         |
| <b>5</b>          | <b>Discussion .....</b>                    | <b>65</b>  |
| 5.1               | Reliability of field investigation .....   | 65         |
| 5.2               | Interpretation.....                        | 65         |
| 5.3               | Evaluation objectives and results.....     | 69         |
| <b>Appendix A</b> | <b>Trench Tables .....</b>                 | <b>73</b>  |
| <b>Appendix B</b> | <b>Finds Reports .....</b>                 | <b>195</b> |
| <b>Appendix C</b> | <b>Environmental Reports .....</b>         | <b>227</b> |
| <b>Appendix D</b> | <b>References .....</b>                    | <b>241</b> |
| <b>Appendix E</b> | <b>Abbreviations and Glossary.....</b>     | <b>246</b> |
| <b>Appendix F</b> | <b>Site Summary.....</b>                   | <b>247</b> |

## Figures

Figure 1: Site location

Figure 2: Trench layout and cropmark features, Land Parcels 3 (North), 30, 31, 35, 103, 104 and 107

Figure 3: Trench layout showing archaeological features and cropmarks, Land Parcel 3 (North) and 30

Figure 4: Trench layout showing archaeological features and cropmarks, Land Parcel 3 (North), 31 and 35

Figure 5: Trench layout showing archaeological features and cropmarks, Land Parcel 103

Figure 6: Trench layout showing archaeological features and cropmarks, Land Parcel 104

Figure 7: Trench layout showing archaeological features and cropmarks, Land Parcel 107

Figure 8: Detailed plan of Trenches 146-50

Figure 9: Sections, Trenches 146-50

Figure 10: Detailed plan of Trenches 141-5

Figure 11: Sections, Trenches 141-3 and 145

Figure 12: Detailed plan of Trenches 134-7, 139 and 140

Figure 13: Sections, Trenches 134, 136, 139 and 140

Figure 14: Detailed plan of Trenches 120-2

Figure 15: Detailed plan of Trenches 156, 165 and 192

Figure 16: Sections, Trenches 120, 156, 165 and 192

Figure 17: Detailed plan of Trenches 172-4 and 176

Figure 18: Sections, Trenches 172, 174 and 176

Figure 19: Detailed plan of Trenches 169, 170, 177, 179 183 and 184

Figure 20: Sections, Trenches 177, 179, 183 and 184

Figure 21: Detailed plan of Trenches 186-9

Figure 22: Sections, Trenches 186-8

Figure 23: Detailed plan of Trenches 38, 40-9 and 51

Figure 24: Sections, Trenches 40-3, 45-48 and 51

Figure 25: Detailed plan of Trenches 51, 54-9 and 61-3

Figure 26: Sections, Trenches 54, 56, 58, 61 and 62

Figure 27: Detailed plan of Trenches 64, 66, 69, 70 and 72-5

Figure 28: Sections, Trenches 64, 66, 69 and 72-3

Figure 29: Detailed plan of Trenches 68, 71, 76, 82, 89 and 90

Figure 30: Sections, Trenches 71, 76 and 90

Figure 31: Detailed plan of Trenches 78, 105-6 and 112-14

Figure 32: Sections, Trenches 78, 105-6 and 112-14

Figure 33: Detailed plan of Trenches 98-100 and 108

Figure 34: Sections, Trenches 98-100

Figure 35: Detailed plan of Trenches 83-6 and 92-3

Figure 36: Sections, Trenches 83-5 and 93

Figure 37: Detailed plan of Trenches 88, 95-6, 102-4 and 111

Figure 38: Sections, Trenches 88, 95-6, 102 and 104

Figure 39: Detailed plan of Trenches 1, 5-7, 14-15 and 17

Figure 40: Sections, Trenches 1, 5-7, 15 and 17

Figure 41: Detailed plan of Trenches 8-11, 13 and 22

Figure 42: Sections, Trenches 8-10, 13 and 22

Figure 43: Detailed plan of Trenches 24-5, and 27

Figure 44: Sections, Trenches 24-5, and 27

Figure 45: Detailed plan of Trenches 31-5

Figure 46: Sections, Trenches 31 and 33-4

Figure 47: Detailed plan of Trenches 195, 198, 200 and 202

Figure 48: Detailed plan of Trenches 207-8 and 212

Figure 49: Detailed plan of Trenches 214-17, 220-1, 224 and 227

Figure 50: Sections, Trenches 214, 217 and 220-1

Figure 51: Detailed plan of Trenches 228, 230-2 and 235-7

Figure 52: Detailed plan of Trenches 243-8

Figure 53: Detailed plan of Trenches 283-5

Figure 54: Sections, Trenches 243 and 283-5

Figure 55: Detailed plan of Trenches 297-8, 300 and 303



## Plates

- Plate 1: Trench 148, looking east
- Plate 2: Ditch 15002, looking south-east
- Plate 3: Section 14100 through ditches in Trench 141, looking south
- Plate 4: Ditch 14309, looking west
- Plate 5: Ditch 14002, looking north-east
- Plate 6: Cremation 13610, looking north-west
- Plate 7: Ditch 13502, looking north-east
- Plate 8: Ditch 18606, looking west
- Plate 9: Posthole 4313, looking east
- Plate 10: Pit 7603, looking east
- Plate 11: Ditches or pits 9804 and 9806, looking south-west
- Plate 12: Ditch 8406, looking south
- Plate 13: Pit 10404, looking north-west
- Plate 14: Pottery dump in pit 10404
- Plate 15: Ditches 11104 and 11106, looking north
- Plate 16: Postholes 103, 105 and 107, looking north-west
- Plate 17: Pit or posthole 703, looking east
- Plate 18: Ditch 3105, looking north
- Plate 19: Ditch 23004, looking north
- Plate 20: Pit 23103, looking north-west
- Plate 21: Ditch 23203, looking east
- Plate 22: Alluvial layer 23506 in section, looking south-west
- Plate 23: Ditch 27310, looking south
- Plate 24: Ditch 23704, looking north-west
- Plate 25: Ditch 24303, looking south
- Plate 26: Ditch 24305, looking south
- Plate 27: Ditches 24403 and 24404, looking north-west
- Plate 28: Ditch 24503, looking north-west
- Plate 29: Ditch 24603, looking north

Plate 30: Ditches 24703, 24705 and 24709, looking west

## Tables

Table 1: Prehistoric pottery assemblage

Table 2: Quantification of late Iron Age and Roman fabrics

Table 3: Quantification by EVE of Roman pottery forms

Table 4: Description of post-Roman pottery by context

Table 5: Summary quantification of the flint assemblage

Table 6: Flint assemblage

Table 7: Ceramic building material assemblage

Table 8: Description of metalwork by context

Table 9: Description of glass assemblage by context

Table 10: Description of worked stone assemblage by context

Table 11: Description of slag assemblage by context

Table 12: Assessment of bulk samples

Table 13: Animal bone assemblage, number of fragments by context and taxon

Table 14: Summary of osteological findings

Table 15: Bone weights per body region

Table 16: Radiocarbon sample detail and calculated age range

## Summary

---

Oxford Cotswold Archaeology was commissioned by Balfour Beatty to undertake a trial trench evaluation of Land Parcels 3 (North), 30, 31, 32, 34, 35, 103, 104 and 107 covered by WSI G of the Lower Thames Crossing Pre-Enabling Works. These Land Parcels are located either side of the A13, and to the south and east of Orsett within the county of Essex and Thurrock unitary authority (NGR 564149, 180821). A total of 167 trenches were excavated and recorded between 28th September and 27th October 2020 across Land Parcels 3, 30 and 35. A further 100 trenches were excavated in Land Parcels 31, 103, 104 and 107 between 17th May 2021 and 22nd July 2021, making a combined total of 267 trenches, over half of which contained archaeological features.

The evaluation revealed a range of archaeological activity dating from the early Neolithic (and possibly Mesolithic) onwards. A single pit containing early Neolithic pottery and flint was recorded in the north-east corner of Land Parcel 30 and residual artefacts of the same date were also recovered from the same area. Worked flint from Land Parcel 107 hint at the existence of earlier prehistoric flint scatters on the edge of the Mar Dyke valley in the north-western part of the site. Evidence of a ring ditch corresponding to a circular cropmark, although very heavily truncated, was found, and this may also be of earlier prehistoric date.

A group of 3 unaccompanied cremations, of which one was radiocarbon-dated to the transition from the early-middle Bronze Age, perhaps indicates a small cemetery group in the west of Land Parcel 3 (North). Otherwise, the evaluation revealed scattered evidence for Bronze Age and Iron Age activity across Land Parcels 3, 30 and 107. There was a slight concentration of evidence in Land Parcel 30, where a low density of ditches and discrete features with small quantities of finds provided an indication of dispersed settlement and associated later prehistoric field systems. However, the limited size of the pottery assemblage and lack of diagnostic pieces has made it difficult to determine the periods of activity more precisely.

Rectilinear cropmarks indicating ditched enclosures in Land Parcel 3 north were confirmed to be Roman in date. Occupation spanned the early to middle Roman periods (mid-1st to later 3rd century AD), apparently peaking in the 2nd and 3rd centuries. There was little evidence that activity continued into the 4th century. Evidence from Trenches 135 to 150 revealed that the activity was well-defined within the ditched enclosures, and concentrations of pits and postholes with associated finds assemblages clearly demonstrate domestic settlement. Evidence for industrial activities is limited, but trial trenching from Hornsby Lane to the south and east has shown that these enclosures were linked to both pottery production and agricultural economies. The rectilinear system of cropmarks to the north of the A13 are likely to be of Roman date and also suggest a focus on an agricultural economy, but due to their peripheral location very few of these features provided reliable dating evidence.

Archaeological evidence dating after the Roman period was overall sparse, but notable features in Land Parcel 30 included an isolated pit of early/middle Anglo-Saxon date in Trench 76 and a medieval pit with a large assemblage of pottery in Trench 104 at the south-east corner. Two trenches in Land Parcel 104 contained features with medieval pottery, quern fragments and iron slag from both smelting and

smithing. During the post-medieval period, the site was almost entirely used for agricultural activity.

A large number of undated features was found across most of the land parcels, and indicate that the density of activity of any of the periods mentioned above may well increase when more of these features are exposed and further dating evidence becomes available.

## Acknowledgements

---

Oxford Cotswold Archaeology would like to thank the client, Balfour Beatty, for commissioning this project and managing the site safety and attendances. Thanks are also extended to the Historic Environment Consultants (Richard Havis and Katie Lee-Smith) of Place Services at Essex County Council, who advise the Borough of Thurrock, for monitoring and providing advice throughout the project.

The project was managed for Oxford Cotswold Archaeology by Steve Lawrence and the fieldwork was directed by Mark Dodd. In 2020 fieldwork in Land Parcel 3 (North) was supervised by Victoria Green, in Land Parcel 30 by Ben Slader and in Land Parcel 35 by Kat Whitehouse. They were supported by Eilidh Barr, Richard Spencer, Heloise Meziani, Rachel Alexander, Ben Camp, Chris Griffiths, Jacopo Gelmi, Nat Pacholek, Joao Heitor, Charlotte Brown, Meagan Mangum, Alex Capon, Stephen Foster, Kerree Kendall, Ellie Brown, Owen Lazarri, Tom Collie, Martha Carruthers, Alice Golton, Beth Hardcastle, James Maccallum, Anne-Laure Bollen, Tamara Hadnagyav, Ed Cole and Christof Heistermann. Site survey was undertaken by Caroline Souday and Jessica Domiczew and digitising was carried out by Caroline Souday and Magda Wachnik.

In 2021 fieldwork in Land Parcel 30 was supervised by Jack Easen, in Land Parcel 103 by Tim Lewis, and in Land Parcels 104 and 107 by Kat Whitehouse. In 2021 the fieldwork was supervised by Jack Easen, Tim Lewis, Kat Whitehouse, and they were supported by Anne Laure Bollen, Rose Britton, Alex Capon, Marionna Sandin Catacora, Jessica Domiczew, Kerree Foster, Stephen Foster, Nathan Griggs, Chris Griffiths, Jack Heathcote, Bethan Morgan, Tanya Peter, Ashley Pooley and Molly Vowles. Site survey was undertaken by Caroline Souday and digitising was carried out by Caroline Souday and Magda Wachnik.

Thanks are also extended to the teams of OA staff that cleaned and packaged the finds under the management of Leigh Allen and Geraldine Crann, processed the environmental remains under the management of Rebecca Nicholson, and prepared the archive under the management of Nicola Scott.

# 1 Introduction

---

## 1.1 Project details and scope of work

- 1.1.1 The Lower Thames Crossing Project is located between the A2 in Kent and the M25 in the London Borough of Havering. It will run underneath the River Thames through a tunnel and emerge on the northern side of the river at East Tilbury. From the North Portal the road will run to the M25 at Junction 29 via the A13 and pass between North and South Ockendon. The development of the project is managed by LTC, a partnership between Highways England and a consultancy joint venture set up to oversee the scheme.
- 1.1.2 A programme of archaeological trial trenching commenced in the Essex part of the scheme in November 2019. A scheme-wide specification for trial trenching was written by LTC (Highways England 2018), and in July 2019, LTC commissioned Balfour Beatty to deliver the pre-Enabling Works. Balfour Beatty appointed Oxford Archaeology (OA) to prepare a project-wide written scheme of investigation (WSI) for the scheme, which (at the request of the key archaeological stakeholders) was divided into two parts, one for the Kent section and another for Essex and Havering (Oxford Archaeology 2019a; 2019b).
- 1.1.3 Following completion of the project-wide WSIs, OA was instructed to prepare a series of site-specific or group-site-specific WSIs for approval by the key archaeological stakeholders in advance of trial trenching to inform the Development Consent Order. A detailed WSI was created for Land Parcels 3 (North), 30, 31, 32, 34, 35, 103, 104 and 107 prior to the trial trenching (WSI G, Oxford Archaeology 2020a), which detailed the archaeological background and potential within the site. It also set out the archaeological aims and objectives appropriate to the investigation of this Land Parcel by trenching and described the methodology to be applied. The WSI was approved by Richard Havis, Principal Historic Environment Consultant for Place Services at Essex County Council, prior to the start of the fieldwork.
- 1.1.4 Oxford Cotswold Archaeology was commissioned as Balfour Beatty's archaeological contractor to undertake the evaluation in accordance with the approved WSI and local and national planning policies. The fieldwork in Land Parcels 3 (North), 30 and 35 was completed between 28th September and 27th October 2020. The remaining fieldwork was carried out between 17th May and 22nd July 2021.
- 1.1.5 All work followed the MoRPHE Project Manager's guide (English Heritage 2015), and the Code of Conduct of the Chartered Institute for Archaeologists. The archaeological works adhered to the standards and guidance for archaeological evaluation, excavation and archiving (ClfA 2014a; ClfA 2014b).
- 1.1.6 The work was monitored by Richard Havis and Katie Lee-Smith of Place Services on behalf of the Borough of Thurrock.

## 1.2 Location, topography and geology

- 1.2.1 The area covered by WSI G lies within the county of Essex and Thurrock unitary authority (NGR 564149, 180821) and is located either side of the A13 south of the village of Orsett, and also extends up the west side of the village (Fig. 1). The WSI covers an area of 95.96ha. Land Parcels 31, 34, 35 and 103 are located just north of the A13, crossing Mill Lane, Rectory Road and the A128, and Land Parcels 3 (North), 30, 32, 33 and 104 are located south of the A13 and either side of the A1013. The easternmost of these, Land Parcel 104, lies immediately north of the modern suburb of Orsett, separate from the historic village centre. A further corridor runs north to the west of Orsett across the B188 and then west through Land Parcels 105–107 around the hamlet of Baker Street. Land Parcel 3 is part of a large field, the southern part of which was the subject of a separate WSI (WSI C), which has already been evaluated by trenching. The parts of Land Parcel 3 within WSI G are called Land Parcel 3 (North).
- 1.2.2 The bedrock geology of the majority of WSI G is Lambeth Group gravels with a small amount of Thanet Sand at the southern edge of the site (BGS 2020). The superficial geology of the site is mixed, the Lambeth Group gravels and the Thanet Sand being overlain in the western third of the site by the Boyn Hill Gravel Member (sand and gravel) and in the central third by a band of Head Clay running from NW–SE along a dry valley. Patches of Black Park sand and gravel overlie the eastern part of the site. Parts of the corridor west of Orsett and the area immediately north of the Orsett suburb have no recorded superficial deposits.
- 1.2.3 Land Parcels 3(north),30, 31, 33, 35, 103 and 104 form part of larger arable fields whilst Land Parcels 32 and 34 are made up of small pasture fields. Mobbs Farm is located west of Mill Lane within Land Parcel 34. Land Parcels 105 and 106 are arable, while Land Parcel 107 is a mixture of pasture and arable fields. Within the 1km site buffer the land use is a mixture of agricultural land and urban development associated with the village of Orsett. The village of Orsett is split, the northern historic core of the village situated 0.5km north (and east) of the site and the modern housing estates of Orsett located to the south-east, just south of the site. The area between Land Parcels 3 (North) and 104 west of the junction of the A13 and the Brentwood Road is used as a recycling centre and also as a quarry. The area is also divided by the A13, A1013 and the A1089, which have displaced the historical field boundaries.
- 1.2.4 The eastern part of the site lies upon an upland area to the south and west of Orsett. A dry valley crosses the western part of the site orientated north-west to south-east. West of this the ground rises again. The eastern part of the site rises sharply up to the gravel terrace, which is at 30–34m aOD. To the east the Boyn gravel terrace is lower than on the west, approaching 26m aOD. The Mar Dyke river lies 2.7km to the north-west, and this is the nearest large river to the site.

## 1.3 Previous investigations

- 1.3.1 A small archaeological excavation was undertaken immediately south of Land Parcel 31 in 1979 during the widening of the A13. The results of this investigation are discussed below (Wilkinson 1988).
- 1.3.2 In 1946 a rhomboidal, double-ditched enclosure was identified by aerial photography within the eastern part of the site. This site, known as 'Orsett Cock' was trial-trenched in 1956–7 and watching briefs took place in 1960–61 and in 1968–70 as part of the laying of gas pipelines. This site was subsequently excavated in 1976–9 in advance of the A13 widening. The archaeological investigations found that this site was occupied as a defensive enclosure in the middle to late Iron Age and subsequently as a farmstead with pottery kilns during the Roman period. Evidence was also found of Saxon occupation of Orsett Cock including five sunken-featured buildings (Carter 1998).
- 1.3.3 The A13 was landscaped during the 1970s widening scheme and this landscaping is very likely to have truncated archaeological remains within the footprint of this scheme.
- 1.3.4 In 2018–19 there were junction alterations and further widening to the A13 within the area of the site and for several kilometres north-eastwards. Trial trenching by LP Archaeology was followed by several targeted excavations in 2019, and a summary of the findings of the evaluation and excavation was kindly provided by John Duffy in advance of completion of the report. The investigation was split into eight areas (A-H): Areas E, G and H lay within the site and Areas A and B just south and east respectively. Further east, Area D had already been heavily truncated by the construction of the A13, while Area C, 2km to the north-east, contained the most archaeology, comprising Mesolithic pits and medieval and post-medieval ditches.
- 1.3.5 Area E, within the A13/A128 junction traffic island, revealed very little surviving archaeology, while trenching further west confirmed linear features known from cropmarks, and recorded further linear features and pits; these were confirmed by small excavations at Areas G and H to the west of the junction, but were mostly undated. A sequence of Roman ditches was also recorded in Area H, just south of Land Parcel 35, and several other ditches contained a small quantity of prehistoric and medieval dating evidence. Areas A and B, east of the A13/A128 junction, also confirmed linear cropmark features, and these were tentatively interpreted as part of a prehistoric field system.

## 1.4 Archaeological and historical background

- 1.4.1 The chronological summary of known archaeology given below is taken from WSI G (Oxford Archaeology 2020a). This covers all of the land parcels within the WSI rather than just the areas accessible within this phase of evaluation fieldwork.
- 1.4.2 **Palaeolithic.** No Palaeolithic finds have been recovered within the site. Palaeolithic finds have been identified 0.2km south of WSI G including four handaxes, one retouched flake and nine flakes. A number of Palaeolithic



finds have also been recorded 0.8–1km south and south-west of WSI G and outside the area of the scheme, including a handaxe and flint flakes.

- 1.4.3 **Mesolithic.** No Mesolithic finds have been recorded within the site. Mesolithic finds spots have been recorded 0.8km south of the site.
- 1.4.4 **Neolithic.** The only known Neolithic find within the site was recovered at Orsett Cock along the line of the A13. A scheduled early Neolithic causewayed enclosure (EH List Entry no. 1009286; Aerial Mapping report site 17A) is located 50m east of the site, and findspots of Neolithic flints have also been recorded in the vicinity.
- 1.4.5 A narrow rectangular enclosure cropmark, aligned east–west with rounded ends is known from aerial photographs in Land Parcel 3 (south) about 100m south of the site, and from its morphology this was suspected to be a mortuary enclosure of Neolithic date. Evaluation trenching, however, indicated that this had been heavily truncated by later agriculture, surviving only as a very shallow ditch, and no dating evidence was recovered (Oxford Archaeology 2020b). This may be a duplicate of a possible long barrow recorded in the HER as 0.2km further south. Neolithic flints have also been recorded across several fields 0.6km south of the site on the boundary of the scheme area.
- 1.4.6 **Early Bronze Age.** The cropmark of a possible ring ditch, which may represent a ploughed-out round barrow, was identified at the western edge of Land Parcel 30 (Aerial Investigations and Mapping Report site 21). An oval ring ditch measuring c 7 x 5m was excavated along the line of the A13 within the eastern part of the scheme (Carter 1998, 165). The ditch contained middle Bronze Age pottery and cremated bone in its upper fills and may have been an early Bronze Age barrow continuing in use into the middle Bronze Age.
- 1.4.7 A large ring ditch is known as a cropmark 180m west of the site, and this is almost certainly of early Bronze Age date. A small cropmark ring ditch lies only 100m north of Land Parcel 31 (Aerial Investigation and Mapping Report site 72), and another small ring ditch, referred to as site 49 by the Aerial Investigation and Mapping Report, was identified 0.5km north of the site. These possibly represent further early Bronze Age barrows.
- 1.4.8 Three early Bronze Age vessels dating to 2500–2000BC were found in a pit within the eastern part of the site during a watching brief on topsoil stripping for the A13 in the late 1970s. This pit was presumed to mark the site of a Beaker burial and lay within an area of multiple cropmarks (Carter 1998, 165).
- 1.4.9 **Later Bronze Age and Iron Age.** WSI G is located 0.5km north-east and south-east of the Orsett (Grey Goose Farm) Cropmark Complex (EH List Entry No. 1002134). This is a scheduled monument that comprises an extensive and dense multi-period site. It includes a number of cropmark small ring ditches, one of which on the west side of the site was shown by evaluation to be of later Bronze Age date, probably representing a burial monument (OA 2020a). The other cropmark ring ditches proved to be of Iron Age date and were probably roundhouse enclosures. Although there was a scatter of pottery of later Bronze Age and early Iron Age date across

this site, this was almost all residual in later features, but supplements the several late Bronze Age to early Iron Age features recorded just south and south-east of this during excavations for the A13 (Wilkinson 1988, 13–16).

- 1.4.10 The eastern part of a prehistoric scheduled monument (EH List Entry No. 1009287) is located within the northern part of the area of WSI G. This monument comprises a circular enclosure that is believed to represent a middle to late Bronze Age Springfield-style enclosure (or ring-fort) and an overlying complex of settlement enclosures containing smaller ring ditches or penannular gullies and pits believed to date to the Iron Age. The large circular enclosure is named after an example excavated at Springfield Lyons, near Chemsford.
- 1.4.11 Despite the evidence of penannular gullies or small ring ditches within it, the integrated complex of enclosures may indicate that this site continued into the Roman period or was in fact largely of Roman date. A pair of converging linear boundaries parallel to the north edge of this enclosure complex may be contemporary, representing a trackway or a succession of boundaries, or could be of much later date, relating to a subdivision of the surviving field pattern.
- 1.4.12 Iron Age settlement activity was recorded west of Rectory Road on the south edge of Land Parcel 31 during the widening of the A13. Four pits (including two grain storage pits), 13 postholes and a possible fence line were recorded (Wilkinson 1988). Two pits contained early Iron Age pottery and two samples of carbonised grain within one of the pits returned radiocarbon date ranges of middle to late Iron Age date:  $160 \pm 80$  BC (HAR 4527) and  $400 \pm 70$  BC (HAR 4635). Other features contained scraps of flint-tempered pottery. This settlement occupied a high point on the Boyn Hill terrace although the excavation also recorded a mixed loamy layer which covered the gravels. This superficial layer, probably Head Clay, covered cropmarks in this area, restricting their identification from aerial photographs (Wilkinson 1988).
- 1.4.13 The Orsett Cock excavation at the A13 roundabout within the eastern part of the site found a scatter of residual middle Iron Age pottery. During the late Iron Age, a sub-square enclosure was constructed along with a timber posthole building. This was followed by a larger triple-ditched enclosure of late Iron Age/early Roman date. A number of Iron Age spearheads were found within the backfill of the triple-ditched enclosure (Carter 1998). Two large oval pits containing early Iron Age pottery, a loom weight and hearth debris were recorded in a watching brief 0.5km east of the Orsett Cock enclosure and within the eastern part of the site.
- 1.4.14 A number of other features and cropmarks have been recorded close to the Orsett Cock enclosure. This includes a cropmark probable enclosure and pits that were identified by the aerial survey (site 72) within Land Parcel 31 and within the rest of the field to the north. There is also a cropmark complex (Aerial Survey site 16) in the fields to the east and within the north-eastern part of the site. These extensive cropmarks cover an area of 90ha. The north-westernmost element of this is a partial curvilinear enclosure with a probable cluster of pits, and only 80m east of this is a sub-rectangular large enclosure containing a penannular enclosure, both of which may well be

later prehistoric. Some 200m east again there is a small ring ditch and another sub-rectangular enclosure, together with a scatter of discrete features, all of which may be prehistoric. The site includes several linear features, rectilinear features and a circular feature within the south-eastern part of this cropmark complex. A number of linear features corresponding to cropmarks were found south and east of the site during the 2018–19 A13 archaeological works. Most of these did not produce dating evidence, although some in Areas A and B were tentatively dated to the prehistoric period (J Duffy pers. comm.).

- 1.4.15 The Neolithic causewayed enclosure (EH List Entry No. 1009286) located 50m east of the site was overlain by an unenclosed early Iron Age site and a middle Iron Age sub-rectangular enclosure (Hedges and Buckley 1978, 219–308). Cropmarks including pits, linear features and ring ditches extend from the area of the scheduled early Iron Age enclosure both south-west and north-west (Aerial Mapping Report sites 17A, 17B and 72). Within these another sub-rectangular enclosure may also be of Iron Age date.
- 1.4.16 A large quantity of high-status Iron Age material was recovered by metal detectorists adjacent to the site. This findspot may have been located within an extensive rectilinear enclosure located in the vicinity of the Iron Age finds in Land Parcel 3 (South). Evaluation has shown that a group of smaller enclosures on the east side of this were of late Iron Age or very early Roman date, but that the major part of the enclosure was of Roman date (OA 2020b). Two Iron Age vessels were also found just north of Land Parcel 34 and are now kept in Orsett Church.
- 1.4.17 **Roman period.** During the late Iron Age/early Roman period a triple-ditched enclosure measuring c 90m long by 80m wide was constructed at Orsett Cock within the eastern part of the site. This continued in use throughout much of the Roman period, with a succession of round and rectangular buildings and four pottery kilns. The site was interpreted as a Romano-British farmstead that developed into a pottery production site (Carter 1998, 1–10). Early Roman pottery was also found just south-east of Orsett Cock and just at the edge of the site. Another Roman enclosure was recorded before the A13 widening within the easternmost part of the site, but only the south-east corner of this enclosure was recorded. North-west of the Orsett Cock enclosure is an extensive complex of cropmark enclosures, trackways, fields and probable pits. The south-eastern part of this complex is located within the north-eastern part of the site. A rectilinear arrangement of trackways or double ditches is orientated on the same alignment as some of the post-medieval field boundaries, so these may be late in date, but they incorporate a large sub-rectangular enclosure that is thought more likely to be of late prehistoric date, suggesting that the system may well prove to be Roman. Several linear features and part of a possible trackway are located within the area of the site. A sequence of Roman ditches was recorded in Area H south-west of the Orsett Cock junction during the 2018–19 A13 archaeological works (J Duffy pers. comm.) and were presumably related to the Orsett Cock triple-ditched enclosure.
- 1.4.18 The lines of two possible Roman roads cross the eastern part of the site. The more westerly of these roads is on a NNW–SSE alignment and is

believed to pass between the Orsett Cock enclosure and the Roman enclosure further to the east. The other proposed Roman road lies further east and is suggested as running on a NW–SE alignment from Orsett Hall to East Tilbury. Two Roman findspots were recorded close to the line of the western road, but no definite evidence for these roads has been recorded.

- 1.4.19 Another extensive cropmark complex that includes one very large rectilinear enclosure and several smaller ones linked by trackways or field boundaries was identified by the aerial survey partially within the southern part of the site (Aerial Investigations and Mapping Report site 20). The large enclosure is on a north-west to south-east alignment and contains subdivisions, pits and curvilinear smaller enclosures. Recent trial trench evaluation for the scheme in Land Parcel 3 (South) has revealed ditches and other features belonging to the southern part of an enclosure containing Roman pottery, confirming their Roman date (OA 2020b). Pottery kilns were also discovered in the area of WSI C in Land Parcel 3 (South).
- 1.4.20 A cluster of Roman find spots have been recorded just north of the settlement of Orsett and 0.5km east of the site. This suggests Roman activity in this area.
- 1.4.21 In the wider area, several possible Roman sites lie on the gravel ridge 0.5–1.5km north-west of the site. These comprise a late Iron Age to late Roman farmstead, the scheduled Orsett (Grey Goose Farm) Cropmark Complex (EH List Entry No. 1002134), which evaluation has shown includes Roman enclosures (OA 2020a), and another possible Roman enclosure just to the east of it.
- 1.4.22 **Medieval period.** Early to middle Saxon activity has been identified east and south-east of the Land Parcel. A Saxon settlement was located at Orsett Cock, within the eastern part of the site in the area previously occupied by the Roman settlement enclosure. The Saxon occupation of the Orsett enclosure comprised five sunken-featured buildings with associated pottery dating to the 6th and 7th centuries. Several further buildings were found outside the enclosure to the east along the A13 and north-east at Barrington’s Farm within the site (Milton 1987). During the excavations at Barrington’s Farm six Saxon features were recorded including three sunken-feature buildings, and these contained Anglo-Saxon pottery dating to AD 400–700. Other features probably of Saxon date were also found in this area. Several undated field boundaries post-date these early Saxon features and indicate that a later field system was imposed on this area (Carter 1998). These are likely to be later medieval or post-medieval field boundaries.
- 1.4.23 The Orsett Neolithic causewayed enclosure (EH List Entry No. 1009286) located 50m east of the site was reused as a Saxon cemetery comprising five small ring ditches in the 7th–8th centuries. The aerial investigation and mapping survey that was undertaken as part of the project identified a large number of linear cropmarks and pits around the causewayed enclosure, which may date from the prehistoric to the medieval period (Aerial Investigation and Mapping Report site 17). The cropmark of a similar penannular small ring ditch is visible 200m north-west of the Orsett Cock enclosure and may indicate another middle Saxon burial site.

- 1.4.24 A dense pattern of individual cropmarks of varying size and shape are dispersed across the Orsett Cropmark Complex (EH List Entry No. 1002134; Aerial Investigation and Mapping Report sites 13 and 14) located 0.3km west of the site. These were interpreted as pits, and some were thought likely to represent Saxon sunken-featured buildings (Place Services 2019). Evaluation of this site has not, however, produced any Saxon finds, and the discrete cropmarks have mostly proved to be geological in origin (OA 2020a). A Saxon clay loomweight was, however, recovered from work along the line of the A13 south of the monument (Wilkinson 1988).
- 1.4.25 Some of the discrete features identified from cropmarks within Land Parcels 30 and 35 are also of similar size to sunken-featured buildings, but these may also prove to be geological, or alternatively, as the ‘pits’ are of a variety of sizes and shapes, some rather irregular, many may prove to be small quarries of medieval or later date.
- 1.4.26 In the late Saxon and later medieval period the site was located within the manor and parish of Orsett. The Domesday survey recorded the settlement of Orsett as having 61 householders, 30 plough teams, six cattle, 40 pigs and 115 sheep in 1086. This manor belonged to the Bishops of London (St Paul’s). This manor also had enough woodland to accommodate 1000 pigs (Palmer 2019). This documentary evidence suggest that the economy may have been a mixture of arable and pastoral and that some parts of the parish were wooded.
- 1.4.27 Bishop Bonner’s Palace is a scheduled monument (EH List Entry No. 1002196) located 0.3km north-east of the site. This ring and bailey earthwork is likely to date to between the late Saxon period and the later 12th century and may have been the seat of the Orsett manor belonging to the Bishops of London as mentioned in Domesday.
- 1.4.28 The later medieval nucleated settlement of Orsett was located just outside the site on the north and east. The church of St Giles and All Saints is Grade I listed (EH List Entry No. 1147049) and is located c 0.5km east of the site. This church dates to the 12th century. It is likely that in the later medieval period the Land Parcel was used as agricultural land associated with the settlement of Orsett. A number of roughly north–south aligned droveways have been observed as cropmarks within the wider area and these may have been used to take livestock to and from the marshland and the upland ridge. Mill Lane and Rectory Road may be medieval in origin, and a group of cropmark trackways south of Orsett on either side of Rectory Road and on the same orientation or at right angles may also date from the medieval period, as may some of the enclosures within this system. One of these possible droveways passes through the north-eastern part of the site, although this may instead be earlier in date.
- 1.4.29 **Post-medieval period.** Documentary evidence indicates that the site was situated either side of a SW–NE road from Stifford to Stanford. The site was also located 0.5km south and 0.4km west of the village of Orsett and 0.5km north-east of the hamlet of Orsett Heath. Several NNW–SSE aligned roads are shown in the vicinity of the site on the 1840 tithe map of Orsett (D/CT 264/1a) and the late 19th-century OS maps. This includes Baker Street and

Fen Lane, located to the west and north-west of the site, and Mill Lane, Rectory Road and the small track west of Barrington's Farm, which bisect the centre and eastern part of the site.

- 1.4.30 A number of listed buildings are located in close proximity to the site, but not within the site itself. The majority of these are post-medieval buildings situated in the nucleated settlement of Orsett, and these will not be discussed in detail.
- 1.4.31 Orsett Hall was the major manor house for this area and was located 900m north of the site, but it burnt down in 2007 leaving only a boundary wall (EH List Entry No. 1392465). Orsett Hall was the seat of the Manor of Orsett and this may have incorporated land originally belonging to the medieval Bishop Bonner's Palace (EH List Entry No. 1002196). The south-eastern part of the site, adjacent to the Orsett causewayed enclosure (EH List Entry No. 1009286), may have belonged to Seaborough Hall, a post-medieval manor house that was demolished in the early 20th century.
- 1.4.32 The listed buildings that related to the historic land use of the north and north-western part of the site include the Old Hall Farm House (EH List Entry No. 1111592), Orsett House (1111610) and Poplars Farmhouse (1146717). Three 18th-century farmhouses are located in the vicinity of the southern and eastern parts of the site including Whitecrofts Farmhouse (1111566), Heath Place (1111575) and Loft Hall (1111649). There are also several cottages that are listed in the vicinity of the site including a 17th-century cottage (1111644) and a pair of 19th century cottages (1337056) along Baker Street, the 18th-century Murrells Cottages (originally named Prattocks) (1337096) along the Stifford–Stanford Road and Slades Hold Cottages dating to the 17th century (1111608) along High Road.
- 1.4.33 Several non-designated post-medieval farm buildings and cottages were located within or close to the site along Baker Street, Mill Lane and the Stifford-Stanford Road. This includes a post-medieval post mill that was located west of Mill Lane and just east of the site. The circular base for this mill is extant and may date to the 17th century. Five Chimney Cottages were located within Land Parcel 30 and adjacent to the Stifford–Stanford Road (now the A1013). The 1840 tithe map and the OS map of 1873 show several buildings at Five Chimneys, which were replaced by the mid-20th century with one long building. Potash Cottages were located in Land Parcel 32 and adjacent and north of the Stifford–Stanford Road. These cottages are shown on the 1840 tithe map and the OS map of 1873 and were also demolished by the mid-20th century, although there appear to have been cottages south of the A1013 that were also called Potash Cottages.
- 1.4.34 The Stifford–Stanford Road (A1013) appears to have been widened in the mid-20th century, which may have led to the demolition of several buildings along its route. Mobbs Farm was located just west of Mill Lane within Land Parcel 34. The tithe map indicates this farm belonged to the Orsett Poor and it is shown on subsequent later 19th century OS maps. There is still a farm at this location, although the original farm buildings may have been demolished. Another terrace of cottages was located in the eastern part of the site and north of the Stifford–Stanford Road. These cottages were

shown on the 1841 tithe map and on the late 19th-century and 1920s OS maps as Ridgwell Cottages. These cottages are not shown in OS mapping after the 1930s and so must have been demolished by this date. Other farmhouses located in the vicinity of the site included Barringtons Farm and Cock Farm just east of the site and Nevilles Farm located just west of Land Parcel 30.

- 1.4.35 Orsett House is a Grade II\* listed building and is located 70m east of the site. This building was constructed in 1740 for Captain Samuel Bonham (Bettley and Pevsner 2007, 619) and the tithe map indicates that Orsett House remained in the Bonham family until at least the mid-19th century. In the later post-medieval period, the Land Parcel was used as agricultural land associated with several farmsteads in the vicinity. The 1841 tithe map provides details of the tenants and the land use at the time.
- 1.4.36 The area of the site has seen a number of developments in the 20th century (including the A13) which have impacted on the historic landscape. Several post-medieval field boundaries are preserved within the site including two linear field boundaries in Land Parcels 30 and 3 (North) which were shown on the tithe map of 1841.
- 1.4.37 During the Cold War a nuclear monitoring post was constructed to the north of the A13 within the boundary of the site. Monitoring posts were constructed below ground with equipment on the surface. It is possible there may be remains of this structure below ground (Subterranea Britannica 2019).
- 1.4.38 In the later 20th century a new housing estate was built immediately south-east of the site which became an outlying part of the settlement of Orsett, located south of the A13. During this period several fields in the vicinity of the site were subjected to quarrying. In the 1960s the fields directly north of Land Parcel 34 were quarried, and this may have extended southwards into the Land Parcel. In the late 1970s/early 1980s the route of the A13 was landscaped in advance of the A13 widening scheme. This caused disturbance of areas of land directly west and north of the site. It is possible that further areas of the site may have been truncated by the A13 scheme, although how far this disturbance extended beyond the footprint of the A13 is unknown.
- 1.4.39 **Undated features and cropmarks.** Cropmarks identified within the southern part of the site and just to the south include linear features, a curvilinear feature and a possible double-ditched trackway. These have been identified by aerial photographs (Aerial Investigations and Mapping Report site 17A). It is possible that these features may be later prehistoric or Roman in date, but there is insufficient evidence to characterise them as such.
- 1.4.40 A number of cropmarks have been identified south-west and west of the site and south of the A13 (Aerial Investigations and Mapping Report sites 21 and 23). The area to the west of Nevilles Farm, 0.5km west of the site, includes cropmarks of possible enclosures, linear features, large sub-circular pits and a ring ditch. Further east, and immediately south of Land Parcel 30, extensive groups of pits were identified across a wide area. A cropmark complex just south of Orsett is also currently undated. These

cropmarks could be dated to the prehistoric, Roman, Saxon or medieval periods, as demonstrated from nearby activity, and have been discussed under the relevant chronological headings above.



## 2 Project Aims

---

### 2.1 General aims

2.1.1 The general aims of the project were as follows:

- i. To establish the presence or absence of archaeological remains along the line of the scheme, and the extent of any areas where remains appear likely to be absent.
- ii. In areas where archaeological remains are known or suspected, to clarify the reliability of the cropmark or geophysical survey evidence.
- iii. In areas where no archaeological remains are indicated by aerial or geophysical survey, to clarify whether this apparent absence of remains is genuine.
- iv. To determine the degree of complexity of any surviving horizontal or vertical stratigraphy, and in particular to investigate areas where topography indicates the likelihood of deep deposit sequences for evidence of buried archaeological horizons and palaeo-environmental sequences.
- v. Where remains are present, to determine the period(s) represented, the extent, state of preservation and character of the archaeological remains.
- vi. To establish the range and state of preservation of archaeological artefacts, and through their recovery and examination, to establish the potential for information about the economy, status and contacts of past inhabitants of the scheme footprint.
- vii. To determine whether palaeo-environmental remains are preserved, and, where these are found, to determine their types (eg charred plant remains, waterlogged remains, molluscan remains), state of preservation and potential for environmental information. This will be achieved through the recovery of samples from sedimentary sequences and archaeological features suitable for assessment of a range of palaeoenvironmental remains (eg charred and waterlogged plant remains, charcoal, insects, pollen, diatoms, ostracods/foraminifera and molluscs) and scientific dating (eg radiocarbon and OSL dating).
- viii. To investigate and record the extent, character and chronology of the sedimentary sequences, in particular those immediately adjacent to and in floodplains, contained within palaeochannels or in dry valleys, and to use the data to refine existing geoarchaeological (predictive) deposit models.
- ix. To place any identified archaeological remains into their local and, where appropriate, regional or national context, and to assess the implications of any such discoveries for our current understanding of settlement and landscape change in the area, including an assessment of the associations of any remains with reference to the historic landscape.
- x. To provide sufficient information to enable the LTC archaeological advisor, in consultation with the Key Archaeological Stakeholders, to determine the significance of the archaeological assets identified within the Land Parcel.

- xi. To provide a report on the discoveries to inform the Environmental Statement (ES) supporting the Development Consent Order (DCO) and support the preparation of a further archaeological mitigation strategy for the Enabling Works and Construction phases of the scheme.
- xii. Following the DCO, to deposit the report in the public domain, and to generate an accessible and useable archive which will allow future research to be undertaken.

## 2.2 Specific objectives

2.2.1 The specific project objectives were as follows:

- xiii. To conduct the programme of archaeological investigation within the general research parameters and objectives defined by the revised East of England Research Framework (Medlycott 2011), and to take account of the aims and objectives of the Greater Thames Estuary Historic Environment Research Framework.
- xiv. To clarify through targeting of apparently blank areas whether the cropmarks provide an accurate representation of the range, quantity and types of archaeological features present within the parcel;
- xv. To clarify whether remains of Mesolithic or early Neolithic date exist within the site, and if so, what the relationship of these remains is to the causewayed enclosure, and to the dry valleys and watercourses, particularly the Mar Dyke Valley, within and adjacent to the scheme area.
- xvi. To investigate whether remains of the later Neolithic and early Bronze Age exist within the site, and if so, to establish their character and chronological duration, their relationship to monuments of the same period, and to dry valleys and watercourses, particularly the Mar Dyke Valley.
- xvii. To clarify whether the circular ring ditches within the area of WSI G are the remains of burial monuments or 'shrines' of the Bronze Age, and if so, to establish their date and duration of use within and beyond the period, and to investigate peripheral activity, whether burial, deposits related to visits, or reuse for burial or other purposes in later periods.
- xviii. To further clarify the density and range of sites of the later Bronze Age and Iron Age within the area of WSI G, and (where appropriate) to use both artefactual and scientific dating to assist in establishing whether occupation was long-lasting, repeated or shifting.
- xix. To clarify if there were topographic preferences in the location of later prehistoric sites, ie whether sites are confined to higher ground or also occur within dry valleys and the Mar Dyke Valley, and to determine what contribution (if any) later prehistoric agriculture may have made to the accumulation of colluvium in lower-lying areas within WSI G.
- xx. To establish the extent, character and density of Roman activity within the area of WSI G, and in particular, whether the undated cropmark enclosures north of the A13 are Roman, and if so, establish their duration of use.
- xxi. To determine whether further evidence of pottery production is present within the area of WSI G, and if so, to date and characterise this. To

investigate whether there is any physical evidence of the Roman roads believed to cross the eastern part of the site.

- xxii. To establish the character and date of the widespread pit -like cropmarks across the area of WSI G, and to determine whether these are all archaeological, and, where proven to be so, if they are of one type or period or whether they encompass several types and span several periods of activity.
- xxiii. To clarify the extent and character of the Saxon activity around that found on the A13 at Orsett Cock, and clarify the date and development of this within the Saxon period and its relationship to the middle Saxon burials found at the causewayed enclosure site to the south.
- xxiv. To establish the date of the possible medieval or post-medieval field boundaries that have been identified within the area of WSI G, and whether there is evidence that some of the roads crossing the area may be of medieval origin, perhaps droveways, and have medieval settlements or agricultural structures associated with them.
- xxv. To look for evidence of medieval and post-medieval farmsteads that are recorded on historic maps within the area of WSI G.

## 3 Methodology

---

### 3.1 Constraints

- 3.1.1 Subsequent to the preparation of the WSI, several land parcels were removed from the trenching programme due either to the limited impact anticipated from the scheme or to problems obtaining land access for trenching. These comprise Land Parcels 32, 34, 105, 106 and the eastern part of Land Parcel 107.
- 3.1.2 As well as limited land access, several other constraints have restricted the area of the site available for trial trenching. These include services and unexploded ordnance (UXO). There are high voltage overhead electricity lines crossing Land Parcel 3 (North) and along the A128, and overhead telecommunication lines along the A1013, along Baker Street, along Rectory Road and along the A128 adjacent to the site.
- 3.1.3 There are a number of buried services that cut across the site or are in very close proximity, including water supplies in Land Parcel 3 (North) and along Baker Street, and gas supplies along the A1013.
- 3.1.4 These limitations were considered when designing the detailed trench layout, but the plotted positions of buried services are often only approximate and due to this and to low-hanging overhead cables it was necessary to adjust the locations of approximately 15 trenches immediately prior to excavation. The approximate locations of all trenches are shown by their numbers in Figures 2–7.
- 3.1.5 The following trenches could not be accessed during the fieldwork and were not excavated.
- **LP 3 (North)** – 115, 116, 117, 118, 138, 158, 159, 162 and 163
  - **LP 35** – 2, 3, 4, 18, 19 and 36
  - **LP 103** – 193
  - **LP107** – 233, 234 and 252-269

### 3.2 Methodology for the evaluation

- 3.2.1 The combined land area for Land Parcels 3 (North), 30, 31, 35, 103, 104 and 107 was approximately 47ha. A total of 267 trenches were excavated, with three trenches measuring 50m x 2m, one trench measuring 17m x 15m and the remainder measuring 30m x 2m. Combined, these represent a 3.7% sample of the area available for trenching. The locations of the trenches are shown on Figure 2.
- 3.2.2 The trench design was developed to target cropmark features identified by the aerial investigation and mapping report (Place Services 2019), and otherwise to provide even coverage of the blank areas.
- 3.2.3 All trenches were located using a Global Positioning System (GPS) prior to machine excavation. All trenches were excavated using a tracked excavator fitted with a toothless bucket under constant archaeological supervision.

3.2.4 Revealed features were hand cleaned and sampled by hand excavation. They were recording as outlined within the approved WSI. All finds were bagged by context throughout the evaluation and were recovered for further investigation, and soil samples were taken as appropriate.

## 4 Results

---

### 4.1 Introduction and presentation of results

- 4.1.1 The results of the evaluation are presented below and include a stratigraphic description of the trenches that contained archaeological remains. The full details of all trenches with dimensions and depths of all deposits can be found in Appendix A. Finds reports are presented in Appendix B. Environmental reports are presented in Appendix C.
- 4.1.2 Context numbers reflect the trench numbers, unless otherwise stated. For example, ditch 803 is a cut within Trench 8, while pit 1719 is a cut within Trench 17. Environmental samples are indicated by the letter 'S' and numbers in triangular brackets, eg Sample 7 is <S7> and Sample 14 is <S14>.
- 4.1.3 The descriptions are separated and presented by Land Parcel. An overview of the separate Land Parcels and the results for the evaluation is shown on Figures 2–7. Further detailed plans of the trenches that contained archaeological features and selected sections are shown on Figures 8–55.

### 4.2 General soils and ground conditions

- 4.2.1 The soil sequence was broadly similar across the three parcels. Despite the changes in topography, there was little evidence for colluvial accumulation and no buried soil horizons were observed. The natural geology was overlain, where present, by a subsoil deposit which was in turn sealed by the ploughsoil. The composition of the ploughsoil varied between sandy silt and clay silt across the three parcels, depending on the underlying geology.
- 4.2.2 Across parts of Land Parcel 3, particular the higher ground to the east, and some areas of Land Parcel 30 the depth of overburden proved to be remarkably shallow. In some instances, the archaeological horizon was little more than 0.3m beneath the surface.
- 4.2.3 Ground conditions throughout the evaluation were varied due to the differing underlying geology and changes in the weather. Several episodes of heavy rainfall lead to localised flooding in trenches that were excavated onto the less well-drained substrates, but these drained away rapidly.

### 4.3 General distribution of archaeological deposits

- 4.3.1 Archaeological features or finds were located in the following trenches:
- **LP 3 (North)** – 120-2, 134-7, 139-50, 156, 165, 169, 170, 172-4, 176-7, 179, 183-4, 186-9 and 192
  - **LP 30** – 40, 42-4, 46-8, 51, 54-6, 58, 61-4, 66, 68-76, 78, 82-90, 92-3, 95-6, 98-100, 102-6, 108 and 111-14
  - **LP 31** – 297-8, 300 and 303,
  - **LP 35** – 1, 5-11, 13-15, 17, 22, 24, 25, 27, and 31-5
  - **LP 103** – 195, 198, 200, 202, 207-8, 212, 214-17, 220-1, 224, and 227
  - **LP 104** – 283-5

- **LP 107** – 230-1, 235, 237 and 242-8
- 4.3.2 This is a total of 141 trenches, or just over half of the total. The remaining trenches were devoid of features, and will not be discussed further in this report.
- 4.3.3 The evaluation confirmed the presence of several linear and curvilinear features within the site that had been identified as cropmarks by the aerial investigation and mapping report (Place Services 2019). In Land Parcel 3 (North) in particular, there was a strong correlation between the areas with cropmarks and features revealed by the trenching. In the southern portion of Land Parcel 3 (North), there was a concentration of enclosure ditches and associated discrete features, including several unurned cremations in Trench 136. On the higher ground to the east of the parcel, there was also a focus of activity represented by linear boundary features.
- 4.3.4 In Land Parcel 30 there was a more dispersed pattern of activity evidenced by a range of small pits and ditches appearing in low numbers, but fairly evenly spread across the site. The cropmarks in this Land Parcel provide little indication of the distribution of features, as few cropmark features were identified in this field.
- 4.3.5 Land Parcel 35 also revealed a more dispersed distribution of features, with linear ditches corresponding to the cropmarks previously identified, but also a number of discrete features recorded in the western half of the site.
- 4.3.6 Archaeological features in Land Parcels 31, 103 and 104 were relatively sparse, with no notable concentrations evident.
- 4.3.7 Features in Land Parcel 107 were revealed in the eastern and western parts of the area.

#### 4.4 Trenches 146-50 (Figs 8 and 9)

- 4.4.1 Trenches 146, 147, 148, 149, and 150 were located at the south end of Land Parcel 3 (North). They were each targeted on the linear enclosure cropmarks identified at this location. Trench 148 was a larger open area trench designed to incorporate possible discrete features also identified from cropmarks.
- 4.4.2 **Trench 146** was located in the south-west corner of the site approximately 30m west of Trench 147. It revealed a single NE–SW aligned ditch (14602). The ditch measured 0.9m wide and 0.3m deep with a concave profile. It contained a single sterile fill (14603). Two possible features were also investigated in the trench (14604 and 14605). These were both interpreted as natural variations, but it is worth noting that 14605 does coincide with a linear cropmark that was recorded as 14708 in Trench 147.
- 4.4.3 **Trench 147** revealed several features including ditches 14702 and 14708. Both features were orientated NE–SW and matched cropmark features targeted by the trench. Ditch 14708 had steep sides and a slightly concave base, 0.9m wide and 0.3m deep. It was filled by a single deposit of grey-brown silty sand and gravel (14709). Ditch 14702 had a similar profile and was 0.63m wide and 0.21m deep. It contained a single deposit of grey-brown, sandy gravel (14703) and produced a single sherd of middle Bronze Age to Iron Age pottery.

- 4.4.4 Three discrete features were also recorded in the trench. Pit 14706 was just 0.31m in diameter and 0.11m deep. It contained a naturally silted, sterile fill of silty sand. Feature 14710 was more likely to be the remains of a posthole. It measured 0.28m in diameter and 0.3m deep with steep sides and a concave base. It was backfilled with a dark brownish grey, silty sand (14711) and produced a very abraded sherd of middle Bronze Age to Iron Age. Pit 14712 was located at the south-east end of the trench and was only recorded in plan.
- 4.4.5 Feature 14704 was interpreted as a ditch terminus. It was only partially exposed, extending beyond the north-east edge of the trench. It was at least 0.7m wide but just 0.12m deep. It was filled by an orange-brown primary silting deposit 14705.
- 4.4.6 **Trench 148** was located approximately 20m north-east of Trench 147. It revealed several linear ditches and multiple pits and postholes type features (Plate 1), many of which matched with previously identified cropmarks.
- 4.4.7 Ditch 14802 was orientated NE–SW and aligned with ditch 14702 in Trench 147 to the south-west. It had a concave base and moderately steep sides with a single fill of grey-brown silty clay (14803), which produced a sherd of Roman pottery. The south-east edge of the ditch truncated an earlier shallow pit (14804). It measured just 0.3m in diameter and 0,04m deep, but contained a dark silty fill (14805) from which early Roman pottery was recovered and a bulk soil sample collected. Sample 2 yielded only a few charred vetches and weed seeds.
- 4.4.8 Ditch 14806 was in the south-east corner of the trench on a parallel alignment to ditch 14802. It had a similar profile and contained a similar fill but finds were recovered from this feature. The truncated remains of a posthole (14808) survived on the south-east edge of the ditch. It contained a naturally silted fill of light grey sandy silt. Both the ditch and posthole were disturbed in plan at this location by a natural feature, possible an animal burrow (14810).
- 4.4.9 The south-east ends of ditches 14806 and 14802 appeared in plan to be truncated by perpendicular boundary ditch 14813. Ditch 14813 measured 1.5m wide and 0.48m deep with steep sides and a narrow, almost V-shaped base. It contained a primary fill (14814) of grey-brown sandy silt, overlain by a secondary fill of similar, more stony material (14815). No finds were recovered from this feature. The ditch had an undetermined relationship with an adjacent pit 14811. The pit contained a sterile fill of grey-brown sandy silt and produced no finds.
- 4.4.10 Ditch 14813 was investigated again to the north-west in slot 14818 where it converged with an adjacent ditch on a similar alignment (14820). Although the relationship was not certain, it appeared as though ditch 14818 was truncated by ditch 14820. Ditch 14820 measured 1.26m wide and 0.8m deep. It contained a single fill of dark brown sandy silt (14821) and produced two sherds of Roman pottery. It was partially truncated to the south-west by a shallow pit 14822. It had a shallow concave profile with a dark brown silty sandy fill. No finds were recovered from it.



- 4.4.11 In total, 25 discrete features were recorded in this trench. These comprised a mixture of shallow pits and possible postholes, many of which were recorded in plan only and cleaned for surface finds. Excavated examples 14843 and 14838 were both 0.3m in diameter and less than 0.1m deep with fills of greyish brown sandy silt. It is unclear if these are the remains of small pits or postholes, but presumably they have been truncated significantly since their creation.
- 4.4.12 Pit 14816 appeared in plan to be part of a group of intercutting features. Excavation revealed another shallow feature, just 0.26m deep with a concave profile. It contained a dark brown sandy silt (14817), but this was indistinguishable from the fill of what were initially perceived to be separate features. The feature or features filled by deposit 14817 correspond with one of the discrete cropmarks targeted by this trench.
- 4.4.13 **Trench 149** was positioned approximately 30m south-west of Trench 148 and immediately south of Trench 147. It revealed a single NW–SE aligned ditch, corresponding to a previously recorded cropmark feature. Ditch 14902 had a broad concave profile, 0.94m wide and only 0.25m deep. It was filled by a naturally accumulated dark brown silty sand deposit (14903).
- 4.4.14 Posthole 14905 was recorded near the centre of the trench. It had vertical sides 0.3m in diameter and survived to a depth of 0.18m. It contained a single naturally silted fill that presumably accumulated after the post had decayed. No finds were recovered from either feature in this trench.
- 4.4.15 Several other possible features were also investigated in this trench but were determined to be variations in the geology (14907, 14908 and 14909).
- 4.4.16 **Trench 150** was located east of Trench 149 and south of Trench 148. It revealed a total of three linear features with ditches 15002 and 15004 on NW–SE alignment at the northern end of the trench and ditch 15006 on a perpendicular alignment at the southern end of the trench. Both boundary features matched the positions of the linear cropmark features targeted by this trench.
- 4.4.17 Ditch 15002 had moderately steep sides and a broad concave base and was 0.84m wide and 0.32m deep (Plate 2). It contained a fill of greyish brown sandy silt (15003) from which a small quantity of Roman pottery was recovered. It was recut along the south-west edge by ditch 15004, which had a similar profile and fill. No artefacts were recovered from this later feature. Based on their alignment they appear to be the continuation of ditches 14820 and 14813 recorded in Trench 148 to the north-west.
- 4.4.18 Ditch 15006 had a very shallow concave profile and was 1.35m wide and 0.16m deep. It was filled by a naturally silted deposit (15007) from which 19 sherds of Roman pottery were recovered. By extrapolating the alignment of the feature using the cropmark information, it appears to form part of an enclosure, and is likely to be broadly contemporary with ditches 15004 and 15002.

## 4.5 Trenches 141-5 (Figs 10 and 11)

- 4.5.1 This group of trenches was located in the southern part of Land Parcel 3 (North), to the west of Hornsby Lane. They were positioned to target a

rectilinear pattern of cropmarks that extends to the south and the north-east.

- 4.5.2 **Trench 141** was situated to the north-west of this group at the edge of the Land Parcel. Near the centre of the trench was a complex cluster of intercutting pits and ditches (Plate 3; section 14100). The sequence began with a large NW–SE aligned ditch (14115). It measured 1.54m wide and 0.66m deep and was filled by three successive fills (14116, 14117 and 14120). Several sherds of medieval pottery were recovered from fill 14116. The ditch was then recut on its north-east and south-west sides by ditches 14103 and 14105. Each had moderately steep sides and a concave base but they were shallower, between 0.3m and 0.35m deep. No finds were recovered from either of these later ditches. Ditch 14115 and its recuts 14103 and 14105 formed part of a linear boundary that is visible as a cropmark and continues to the south-east.
- 4.5.3 Ditch 14105 was truncated by later pit or ditch terminus 14109, which was in turn truncated by feature 14107. Both features were filled by naturally silted brown sandy silt deposits and neither produced any artefacts. Only identifiable in section following excavation, it remains unclear if these were discrete pits or terminal ends of later boundary recuts.
- 4.5.4 To the west of ditch 14105 was small pit or posthole 14118. It had a shallow concave profile and a single fill of brown sandy silt. No artefacts were recovered from this feature.
- 4.5.5 At the western end of the trench and coinciding with a cropmark linear on a perpendicular alignment to the ditches in the centre of the trench were two further ditches (14111 and 14113). Although these were recorded as two separate ditches, the relationship between them was indistinguishable. It is likely they were actually one large cut, at least 2.6m wide and filled by a single deposit of orange-brown sand. No finds were recorded from these contexts.
- 4.5.6 **Trench 142** was excavated as an L-shape to target a pair of linear cropmarks and a nearby discrete feature. It was positioned 35m south of Trench 141, separated by an overhead powerline. Ditch 14203 was located at the western end of the trench on a N–S alignment. It had a shallow concave profile and a single naturally silted fill (14204) of light brown sand, which produced a sherd of undated pottery and a single horse tooth. Ditch 14207 was approximately 3m to the east and orientated NNW–SSE. It also had a shallow concave profile and was filled by a single deposit (14208). A single sherd of early post-medieval pottery as recovered from this ditch.
- 4.5.7 Pit 14205 was partially exposed against the southern edge of the trench. It measured at least 1.12m in diameter and was excavated to a depth of 0.6m, although not bottomed. The earliest fill (14206) was a deliberate dump of material comprising a dark grey silty sand rich in charcoal, middle Roman pottery and fragments of Roman tile. Bulk soil sample 14, collected from this deposit, produced large quantities of charcoal and smaller amounts of charred cereal grains chaff and weed seeds. This layer was sealed by two naturally accumulated fills (14209 and 14210). A single sherd of Roman pottery was recovered from fill 14209.

- 4.5.8 The two ditches both correlate with the linear cropmarks, but the discrete feature also targeted by the trench was not identified.
- 4.5.9 **Trench 143** was located nearly 15m to the north-east of Trench 142. Numerous ditches were revealed, including a recut boundary (14312) towards the western end that is likely to have been the continuation of ditch 14115 in Trench 141 and its later recuts. Ditch 14312 is most likely to have been the same feature as ditch 14115. It was the earliest and largest in the sequence, measuring 2m wide and at least 0.5m deep. Its earliest fill (14313) was a naturally silted deposit that produced a small quantity of middle Roman pottery. It was overlain by a sterile deposit of stony silt (14314). The western edge of the ditch was then recut by the much smaller ditch 14303, which measured 0.68m wide and 0.3m deep with a single fill (14304). This was in turn truncated to the east by ditch 14305, which had a similar profile but was slightly larger, being 0.92m wide and 0.4m deep. It contained a primary deposit of grey-brown sandy silt (14306), overlain by a dark brown sandy silt deposit (14307) which produced a small quantity of Roman pottery and two degraded fragments of possible rotary quern. The final feature in the sequence was a small pit (14315), which had a shallow concave profile, truncating the edge of ditch 14305. It contained a single sterile fill and no finds.
- 4.5.10 Ditch 14320 was orientated N–S and located immediately to the east of ditch 14312. It had steep sides, measured 1.6m wide and was excavated to a depth of 0.45m but was not bottomed. It was filled by a process of natural silting with two deposits (14321 and 14322). No artefacts were recovered from this feature.
- 4.5.11 Ditch 14309 was situated on a perpendicular alignment to ditch 14320. It measured 0.85m wide with moderately steep sides and a concave base and was 0.3m deep (Plate 4). It was filled by a grey sandy silt deposit (14310), overlain by a thin deposit of brown sandy silt (14311). Both deposits were formed by gradual silting. Only fill 14310 contained any artefactual material, comprising a single piece of well-preserved animal bone (mole), which may have been intrusive. Bulk soil sample 9 was collected from fill 14310 and produced a small quantity of charcoal and a moderate assemblage of terrestrial mollusc shells.
- 4.5.12 The eastern end of ditch 14309 met with a group of intercutting pits (14317, 14318 and 14319). These features were recorded in plan only, but it is interesting to note that they coincide with a N–S aligned linear cropmark and although these appeared to be a cluster of pits, they may be concealing a linear feature.
- 4.5.13 **Trench 144** was positioned 18m south of Trench 143. It revealed a single linear ditch (14406), which had a shallow concave profile, 1.66m wide and 0.24m deep, with a single fill light brown silty sand (14407). It produced four sherds of Roman pottery. Two cropmark features has been plotted in tis location and it is uncertain which one ditch 14406 represents.
- 4.5.14 Several other features were investigated in the trench but were interpreted as natural features (14403, 14404 and 14405).

- 4.5.15 **Trench 145** was located approximately 20m east of Trenches 143 and 144. It revealed several linear and discrete features. Ditch 14513 was located near the northern end of the trench. It was 1.2m wide and 0.4m deep, with a single fill (14514). Ditch 14502 was located approximately 3.5m to the south on a broadly parallel, E–W alignment. It was filled by a sequence of three deposits. The primary fill was gravelly deposit 14503, overlain by naturally silted deposits 14504 and 14505. All three fills were tipping in from the northern edge, suggesting a bank on this side. No finds were recovered from this ditch.
- 4.5.16 Ditch 14510 was orientated NE–SW and matches the position of a linear cropmark recorded to the south-west as ditch 14708 in Trench 147. In Trench 145 it had a shallow concave base and was 0.62m wide and 0.32m deep. At the base of the ditch was a thin primary deposit of sandy gravel (14511), which was overlain by a deposit of brownish grey sandy silt (14512). The later deposit produced three small pieces of middle Roman pottery.
- 4.5.17 Pit 14506 was irregular in plan with a concave profile and was 0.3m deep. It contained a sterile deposit of light grey silty sand. It was truncated to the east by pit 14508. This later feature was smaller, 0.6m in diameter and just 0.16m deep. It contained a similar sterile fill with no finds.
- 4.5.18 Pit 14515 was located at the southern end of the trench. It was sub-circular in plan with a diameter of 0.62m and steep sides leading to a slightly concave base, 0.38m deep. It contained a deposit of greyish brown, sandy silt but no artefacts were recovered.
- 4.5.19 Pits 14517 and 14518 were also identified but were only recorded in plan.

## 4.6 Trenches 134-7 and 139-40 (Figs 12 and 13)

- 4.6.1 This group of trenches were located to the west of Hornsby Lane and targeted the northern limit of the cropmark complex that extends across Land Parcel 3 (North).
- 4.6.2 **Trench 140** was located at the south of the group, approximately 30m north of Trench 145. At the eastern end of the trench was N–S aligned ditch 14007. It had gently sloping sides, leading into a pronounced concave base at the centre of the ditch, and measured 1.7m wide and 0.32m deep. It was filled by a deposit of brown sandy silt (14008) from which middle Roman pottery was recovered.
- 4.6.3 Ditch 14002 was recorded near the centre of the trench. It had an irregular profile with splayed upper edges, becoming very steep towards the broad, slightly concave base (Plate 5). Overall, it measured a little more than 3m wide and 0.6m deep. It contained two thin primary deposits on the eastern side of the ditch (14003 and 14004). These were overlain by deposit 14005, a brown sandy silt containing residual prehistoric and early/middle Roman pottery and an upper fill (14006) comprising dark brown sandy silt, which also produced some pottery. It corresponded with a NW–SE aligned cropmark and is the same feature as ditch 13902 in Trench 139. Although the recorded alignment of ditch 14002 does not suggest a connection with ditch 13902 it is possible that it was more obliquely orientated than realised

at the time of excavation, which might also explain the unusual profile and substantial width.

- 4.6.4 **Trench 139** was situated to the north-west of Trench 140. It exposed a single ditch (13902). Orientated on a NW–SE alignment and matching the cropmark associated with ditch 14002, it appears to be a continuation of the same ditch. It measured 2m wide with steep sides and a concave base and was 0.66m deep. The primary fill (13903) comprised light grey silty sand and produced a combination of residual early Roman pottery, iron fragments and a worn copper alloy coin dating to AD 260–96. This was overlain by upper fill 13904, a deposit of grey-brown, silty clay which also contained fragments of residual late Iron Age/early Roman pottery.
- 4.6.5 **Trench 137** was located approximately 15m north of Trench 139. It revealed E–W aligned ditch 13703, a shallow concave feature, 0.78m wide and 0.2m deep with a fill of grey-brown clay sand. Although slightly offset, this corresponded with a linear cropmark on the same alignment. A second cropmark was also targeted by this trench, to the north on a NE–SW alignment. A change in the natural was investigated that was thought to correspond to this cropmark, but no archaeological feature was identified.
- 4.6.6 **Trench 136** was excavated to the north of Trench 137 and also targeted on the NW–SE aligned cropmark. In this trench two separate ditches, 13603 and 13605, were recorded on the same alignment as the cropmark. Ditch 13603 measured 0.68m wide and 0.16m deep and was filled with a deposit of sterile grey-brown sandy silt. Ditch 13605 as less than 1m to the south-east and slightly larger at 1.3m wide and 0.36m deep, but contained a similar fill to the adjacent ditch, also devoid of finds.
- 4.6.7 A cluster of three unurned cremation burials (13609, 13610 and 13613) were recorded to the north-west of the two ditches (Plate 6). They varied in size and form. No artefacts were recovered from any of the pits, but bone from layer 13611 in burial 13610 was radiocarbon dated to 1690-1510 cal BC (SUERC-96933;  $3328 \pm 24$  BP). Pit 13609 was noted to have signs of heat-affected soil on its southern edge indicating the material was dumped relatively rapidly after collection. Bulk soil samples 4–7 were collected from cremation burial 13610 and yielded large quantities of charcoal and a single charred wheat grain fragment, as well as burnt bone and burnt flint. Eight soil samples (8, 11, 12, 15, 18, 20, 21, 24) were collected from cremation burial 13609, from which large quantities of charcoal were identified, alongside a few charred weed seeds and small quantities of burnt bone and flint. Six samples (10, 13, 16, 17, 19, 23) were collected from cremation burial 13613 and also contained large quantities of charcoal and small amounts of burnt bone and flint. A detailed report on the cremated human bone is provided in Appendix C.
- 4.6.8 **Trenches 134 and 135** were positioned to the north-east of Trench 136 and were both targeted on the same linear cropmark. Ditches 13402 and 13502 appear to be part of the same feature from which the cropmark was derived. Orientated NE–SW, they had moderately steep sides and a concave base up to 1.6m wide and 0.7m deep (Plate 7). In both trenches the ditch was filled by a sequence of three fills. No finds were recovered

from the fills of ditch 13502, but ditch 13402 contained fragments of post-medieval/modern glass and iron objects.

- 4.6.9 Ditch 13402 was recut by a smaller ditch on the same alignment (13405). It contained a single fill and no finds.
- 4.6.10 Trench 135 was also positioned to cross the NE-SW linear cropmark also examined in Trench 136, but did not expose a corresponding ditch.

## 4.7 Trenches 120-2 (Figs 14 and 16)

- 4.7.1 Trenches 120, 121 and 122 were located in the north-west corner of the parcel and positioned to investigate an area without any cropmarks.
- 4.7.2 **Trenches 120 and 122** were located to the west and east of Trench 121, respectively. They both revealed what appears to be the same ditch, orientated ESE–ENE. Ditch 12002 in Trench 120 measured 1.24m wide and 0.52m deep and was filled with a sequence of five naturally silted deposits. Ditch 12202 was recorded just over 61m to the north-east on the same orientation but was slightly different in appearance. It measured 1.36m wide and 0.3m deep with two naturally accumulated deposits. Post-medieval/modern CBM, glass and animal bone were recovered from ditch 12202.
- 4.7.3 **Trench 121** was located in the middle of the three trenches and revealed a single small pit (12102). Circular in plan with a shallow concave base, this small pit contained a single sterile fill. Without any dating evidence and seemingly isolated from other similar features, its date and function are uncertain.

## 4.8 Trenches 156, 165 and 192 (Figs 15 and 16)

- 4.8.1 **Trenches 156 and 165** were both located in the narrow, central strip of Land Parcel 3 (North). Trench 156 revealed small undated pit 15602 and Trench 165 contained a NNE–WSW aligned ditch, 16501. No finds were recovered from either feature, and there is no correlation between these and other features or cropmarks.
- 4.8.2 **Trench 192** was positioned 130m north of Trench 165, to the south of Stanford Road. At the western end of the trench was NNW–ESE aligned ditch 19202. It had an irregular shape and contained loose silty sand deposit with pottery, glass and some iron objects, all of 19th-/20th-century date. Based on the artefacts from this ditch, it is likely to be a field boundary mapped on the 1st edition OS map at this location.

## 4.9 Trenches 172-4 and 176 (Figs 17 and 18)

- 4.9.1 This group of trenches were located in the east of the site in a narrow strip that extended to the south from the east end of the Land Parcel.
- 4.9.2 **Trench 172** was situated at the north-east of the group, against the eastern boundary of the site. At its southern end it revealed NE–SW aligned ditch 17208. It has steep sides and a shallow, broad base and was 2.2m wide and 0.4m deep. It was filled with a deposit of dark grey-brown, silty sand, (17209) which produced CBM and metalwork of post-medieval date.

- 4.9.3 Ditch 17206 was located near the centre of the trench on a broadly parallel alignment to ditch 17208. It was 1.38m wide and 0.34m deep with a broad concave profile. It contained a fill of grey-brown silt sand (17207). No finds were recovered.
- 4.9.4 A third parallel ditch was recorded near the northern end of the trench. Ditch 17202 also had a broad slightly concave profile, measuring 2.1m wide and 0.4m deep. It was filled with a deposit of grey-brown silty sand but produced no dating evidence. However, it was recut as ditch 17204 along its centre line. Ditch 17204 contained a similar, slightly darker fill (17205), which produced several sherds of middle Roman pottery and two fragments of animal bone.
- 4.9.5 Ditches 17202, 17204 and 17206 all matched linear cropmark features at their locations. Although almost identical in appearance, ditch 17208 had no corresponding cropmark.
- 4.9.6 Between ditches 17202 and 17206 were two small pits or postholes (17210 and 17211), which were recorded in plan but not excavated.
- 4.9.7 **Trench 173** was positioned immediately to the south-west of Trench 172, at the possible convergence of five different linear cropmarks. Unfortunately, due to its location at the start of a dry valley that descended to the south-west, only a colluvial layer (17302) was observed at the base of the trench after excavation to a depth of 1m. No features were identifiable.
- 4.9.8 **Trench 174** was located to the south of Trenches 172 and 173. It revealed a single ENE–WSW aligned ditch (17402), which was 1m wide and 0.16m deep with a single fill of silty sand but no associated artefacts. At the south-west end of the trench was a second possible ditch (17404), but this was recorded in plan only.
- 4.9.9 **Trench 176** was situated at the south end of the group, approximately 70m south of Trench 174. A single ditch (17603) was recorded at the northern end. It was broadly aligned E–W, with a slightly irregular shape in plan and an irregular concave profile. It measured 1.54m wide and 0.14m deep. It was filled with a deposit comprising dark brown sandy silt (17604) and contained ten sherds of middle Bronze Age to Iron Age pottery and some burnt stone.

## 4.10 Trenches 169-70, 177, 179 and 183-4 (Figs 19 and 20)

- 4.10.1 This group of trenches were located in the north-east part of Land Parcel 3 (North). Few cropmark features were mapped at this location, so these trenches were distributed to provide an even coverage and test the blank areas. This location is particularly interesting as it provides a remarkable viewpoint across the landscape to the west, south and south-east.
- 4.10.2 **Trenches 169, 170 and 184** were distributed along the western edge of the group and exposed a single linear ditch orientated NNW–SSE that ran through all three trenches (17003, 16902 and 18402). The ditch had moderately steep sides and a concave base and measured between 1.25m and 1.42m wide and up to 0.38m deep. In Trenches 170 and 169 it was filled by a single deposit of grey-brown sandy silt. In Trench 184 the fill

sequence was divided between primary silting episode 18403 and upper naturally silted deposit 18404. Across the three interventions excavated, only deposit 18403 produced any finds, comprising late Bronze Age/iron Age pottery and a piece of perforated fired clay slab/plate of late Bronze Age date.

- 4.10.3 The alignment of this ditch beyond the three trenches is not known, as it was not identified as a cropmark feature and did not appear in the adjacent trenches.
- 4.10.4 **Trench 183** was positioned 25m north-east of Trench 184. At the north-east end of the trench was a wide, shallow linear feature (18309), which was only partially exposed within the trench. It measured at least 1.75m wide and 0.18m deep with a flattish undulating base. It had been filled by a single deposit of grey-brown sandy silt (18310) which produced a sherd of pottery. The feature may be the remnant of a footpath between Heath Place and Prattocks farms that is mapped on the 1st edition OS map.
- 4.10.5 A small pit or posthole (18305) was recorded to the west of feature 18309. It had steep sides and was 0.26m in diameter with a flat, narrow base, and was 0.15m deep with a single fill of sandy silt.
- 4.10.6 Feature 18302 was situated approximately 4m to the west. It measured 0.45m wide and up to 0.7m deep. It was filled by brown-grey sandy silt deposit 18303, which produced a sherd of Roman pottery. The feature was only partially observed as it extended beyond the north-west edge of the trench and had been truncated by ditch 18304. It is uncertain if this was an earlier ditch terminus or in fact a pit. Ditch 18304 had a steep-sided concave profile 1.5m wide and 0.5m deep. It was filled by an initial slump of material (18306), which was overlain by a slower accumulation of sandy fill (18307). No finds were recovered from this ditch.
- 4.10.7 **Trench 177** was positioned to the south-east of Trench 183. It revealed single ditch 17702, which appeared to be the continuation of ditch 18304 in Trench 183. It was slightly shallower at this location than in Trench 183 and was filled by a single deposit of dark brown silty sand (17703). It also corresponded with a linear cropmark on the same alignment, although the cropmark does not extend much further north-west of Trench 177. No finds were recovered.
- 4.10.8 **Trench 179** was positioned in the south-east corner of this group, a little more than 40m east of Trench 177. It revealed two small ditches on perpendicular alignments at its western end. Ditch 17902 had moderately steep sides and a concave base and was 0.6m wide and 0.26m deep. It was filled by a natural silting deposit (17903) and incorporated finds of pottery and slag. The adjacent ditch 17904 was not excavated but was almost identical in appearance.

## 4.11 Trenches 186-9 (Figs 21 and 22)

- 4.11.1 This group of trenches were also located in the north-east corner of the site, on the higher ground adjacent to the Stanford Road. Their positions were evenly distributed as no cropmarks were mapped in this location.



- 4.11.2 **Trench 186** was located to the north-west of Trench 183. At the northern end of the trench was NE–SW aligned ditch 18606 (Plate 8). One of the largest features encountered in this part of the site, it had steep convex sides 2m wide and measured at least 1m deep but was not fully excavated. It contained a single fill (18607), which produced medieval/early post-medieval CBM and a fragment of animal bone.
- 4.11.3 Ditch 18602 was located 4.5m to the south-east on a parallel alignment. It had a broad concave profile and was 1.2m wide and just 0.22m deep, with a single fill of silty sand. A sherd of shelly pottery of 1st-early 2nd century Roman date came from this fill. Ditch 18602 was almost identical to a third, broadly parallel ditch at the southern end of the trench (18604).
- 4.11.4 **Trench 187** was positioned to the east of Trench 186. It revealed single NW–SE aligned ditch 18702, with a similar shallow concave profile and single fill to ditches 18602 and 18604. Situated on a perpendicular alignment, they are likely to have formed part of a broader field system. No dating evidence was recovered from this ditch.
- 4.11.5 **Trench 188** revealed two shallow pits (18802 and 18804). They both contained dark sandy silt deposits but produced no finds and appear to have been heavily truncated. The largest of the two, 18804, measured just 0.13m deep.
- 4.11.6 **Trench 189** was located more than 40m north-west of Trenches 188 and 187. Ditch 18903 was recorded at the north-east end of the trench on a NW–SE orientation. It had a similar profile and fill to the shallow concave ditches recorded to the south in Trenches 187 and 186 and was broadly aligned with ditch 18702. Although it is difficult to be certain this was the same feature over this distance, they may have been part of the same field system. As with the other examples no finds were recovered from ditch 18903.
- 4.11.7 Adjacent to the east of ditch 18903 were pits 18905 and 18907. They were both sub-circular in plan with steep sides and concave bases and were filled by a deposit of dark grey-brown silty sand. No artefacts were recovered from either pit.

## 4.12 Trenches 38, 40-9 and 51 (Figs 23 and 24)

- 4.12.1 This group of trenches are part of Land Parcel 30, located on the northern side of Stanford Road. They were positioned towards the north-west corner of the site, close to the A13. None of the trenches in this group was placed to target a known cropmark.
- 4.12.2 **Trench 38** was located on the north side of the land parcel, close to the west end. It revealed a natural feature (3803) towards the east end.
- 4.12.3 **Trench 40** was located east of Trench 138 against the northern boundary of the land parcel, and north of Trench 44. It revealed two pits (4002 and 4004). Pit 4002 was circular in plan, 0.8m in diameter and 0.22m deep. It was filled with a greyish brown sandy clay deposit with a spread of charcoal at its surface.
- 4.12.4 Pit 4004 was more irregular in plan and extended beyond the southern edge of the excavated area. It was filled with a deposit of grey-orange sandy clay,

not too dissimilar to the surrounding geology. The overall appearance of the feature is that of a geological variation, but two flints were recovered from the surface interface between the fill (4006) and subsoil (4005).

- 4.12.5 **Trench 41** lay south-west of Trench 38 on the western edge of the land parcel. It revealed a small pit or posthole and two possible ditches on a broadly NNW-SSE alignment around 9m apart.
- 4.12.6 Pit 4107 was 0.6m in diameter, although the cut on one side was very shallow, the main feature being 0.4m across and 0.14m deep, with sloping sides and a V-profile. The single fill (4108) was a greyish-red sandy silt without finds or other inclusions. Ditch 4105 lay east of 4107, and was up to 0.55m wide, although the cut on the east was very shallow, the main cut being 0.35m wide and 0.05m deep, while ditch 4103 further east was 0.4m across and 0.07m deep. Both ditches had greyish-red silty sand fills with occasional small stones but no finds (respectively 4106 and 4104). These may have been cultivation furrows rather than ditches.
- 4.12.7 **Trench 42** was positioned east of Trench 41 and more than 60m south-west of Trench 40. It revealed two pits (4203 and 4205) and a possible third pit or ditch terminus (4207). Pits 4203 and 4205 both contained greyish brown silty clay fills. A fragment of middle Bronze Age to Iron Age pottery was recovered from the fill (4206) of pit 4205.
- 4.12.8 Pit/ditch terminus 4207 was almost 1m wide and 0.31m deep. It was filled by a primary silting episode (4209), which was overlain by a natural accumulation of brownish grey silty sand (4208) which incorporated 13th- to 15th-century pottery and animal bone fragments. The final fill was a deposit of yellowish grey sandy silt (4210).
- 4.12.9 **Trench 43** was situated east of Trench 42. Located near the centre of the trench was N–S aligned ditch 4311. It measured 0.8m wide and 0.22m with moderately sloped sides and a concave base. It contained a single deposit of grey-brown silty clay (4312), which produced fragments of animal bone but no dating evidence.
- 4.12.10 To the west of the ditch was a short, ENE–WSW irregular alignment of five shallow postholes (4303, 4305, 4307, 4309 and 4313; Plate 9). Sub-circular in plan, they were all less than 0.1m deep and had shallow gently sloped profiles. Each filled with a deposit of grey-brown silty clay. None of the postholes yielded any artefacts.
- 4.12.11 **Trench 44** was located east of Trench 43 and revealed the remains of possible ditch terminus 4405. It was orientated NW–SE and extended to the south-east beyond the limits of the trench. It had a concave profile and was 0.55m wide and 0.22m deep with a single naturally silted fill of brownish grey clay silt (4406). Middle Bronze Age to Iron Age pottery and prehistoric flint were recovered from the feature.
- 4.12.12 **Trench 45** lay south of Trench 41 and south-west of Trench 42, and contained a single ditch. Ditch 4503 was orientated WSW-ENE, measured 1.42m wide and very steep sides. Excavation was halted at a depth of 0.4m for health and safety reasons, and the ditch was not bottomed. The sole fill exposed was 4504, a greyish-brown clayey sand and occasional stones. A cattle bone was recovered from the fill. The projected line of this ditch

matches that of ditch 4706 to the east, and the two were probably parts of the same boundary.

- 4.12.13 **Trench 46** was positioned to the south of Trench 42. It revealed two parallel ditches spaced almost 15m apart on NNW–ESE alignments. Ditches 4605 and 4603 had broadly identical concave profiles of similar dimensions and were filled with deposit of brownish grey clay silt. However, deposit 4606, the fill of ditch 4605, was rich in charcoal, indicating a dump of burnt material. Bulk soil sample 26, collected from deposit 4606, yielded a large quantity of charcoal and charred cereal grains of wheat and oat, as well as a few weed seeds. Burnt flint was also recovered from ditch 4605. It is possible that the two ditches were broadly contemporary in date.
- 4.12.14 Pit 4607 was located in the western part of the trench and contained a sterile deposit of dark grey-brown, clay silt (4608).
- 4.12.15 **Trench 47** was located to the east of Trench 46 and revealed two ditches. Ditch 4704 was aligned WNW–ESE and had a wide, shallow profile 1.1m across and 0.23m deep. It was filled with a single, sterile clay silt deposit (4705). Ditch 4706 was recorded immediately to the north of 4704 on a WSW–ENE alignment, the two ditches converging at the western baulk of the trench. No relationship was recorded between the ditches, which were nearly identical in appearance, and neither feature produced any finds. Ditch 4706 is on the same line as ditch 4503 to the west, and is probably a continuation of this ditch. Ditch 4704 corresponds with a historic field boundary mapped on the 1st edition OS map.
- 4.12.16 **Trench 48** was situated east of Trench 47 and south of Trench 44. A single oval pit (4804) was observed at the western end of the trench. It contained a single naturally accumulated fill of silty clay and contained no finds. In the remainder of the trench several other possible pits were also investigated but were all determined to be of natural origin (4802, 4803, 4806, 4807).
- 4.12.17 **Trench 49** lay south of Trench 45 and south-west of Trench 46, and revealed a small natural feature (4903) in its eastern half. Trench 50 to its east also contained a single natural feature (5003).
- 4.12.18 **Trench 51** was situated south of Trench 47 and contained two ditches on a NNW-SSE alignment and a natural feature. Ditch 5104 at the western end of the trench was 0.56m wide and 0.1m deep, with a single fill of sterile sandy silt.
- 4.12.19 Ditch 5103 at the east end of the trench was 1.34m wide, but was not excavated. It corresponded with a mapped historic boundary and is likely to be a continuation of ditch 4704 in Trench 47.

## 4.13 Trenches 54-6, 58-9 and 61-3 (Figs 25 and 26)

- 4.13.1 This group of trenches were positioned in the south-west corner of Land Parcel 30, just north of Stanford Road. It includes Trenches 61 and 62, which were targeted on a large annular cropmark, the only cropmark identified in this part of the site.
- 4.13.2 **Trench 54** lay south of Trench 49 on the western boundary of the land parcel, and contained a small pit in the southern half of the trench. Pit 5403 was around 0.65m in diameter and 0.26m deep with sloping sides and a

flat base. The single fill was a greyish brown sandy silt with infrequent gravel and charcoal flecks, and contained crumbs of prehistoric pottery. Environmental sample <S29> was taken from the fill, but produced only a very little charcoal.

- 4.13.3 **Trench 55** was located in the north-west corner of the group, north of Trench 60 and west of Trench 56. It revealed a single linear feature aligned NNW–SSE (5503). Like so many of the ditches in this part of the site, ditch 5503 had a shallow concave profile and was just 0.41m wide and 0.11m deep. It was filled with a sterile deposit of light grey sandy silt.
- 4.13.4 **Trench 56** was excavated to the east of Trench 55. At the southern end of the trench was NE–SW aligned ditch 5603. It measured 0.96m wide and 0.3m, with steep sides and a rounded base containing a naturally silted clay silt deposit. At its south-west end, the ditch met NNW–SSE aligned linear feature 5607. It is possible that 5607 is the continuation of ditch 5104 based on their common alignment.
- 4.13.5 **Trench 58** was situated 80m east of Trench 56. It revealed NE–SW aligned ditch 5803. The ditch had steep sides and a flattish base and was 0.84m wide and 0.28m deep. It was filled with a sterile, grey-brown clay silt deposit (5804).
- 4.13.6 Several possible features to the north of the ditch were investigated and determined to be of natural origin (5805, 5806).
- 4.13.7 **Trench 59** to the south of Trench 54, and **Trench 60** to the south-east, both contained soilmarks that proved to be further natural features (5903, 6003-4 and 6006-7).
- 4.13.8 **Trench 61** was located south of Trench 56, close to Stanford Road. It was targeted on an annular cropmark feature approximately 20m in diameter. A little more than 5m from the north-east end of the trench a very shallow cut (6103) was observed in section, measuring almost 1.9m wide and just 0.12m deep. During cleaning, several small sherds of pottery of either early Neolithic or later Bronze Age/Iron Age date were recovered from its fill (6104). It is possible that feature 6103 represents the remains of the cropmark feature.
- 4.13.9 Ditch 6109 was located almost 9m south-west of ditch 6103. Broadly aligned N–S, it had a shallow concave profile, filled with a sterile deposit of light grey sandy silt (6110).
- 4.13.10 Ditch 6107 lay parallel to ditch 6109, some 2.2m further south-west. It was slightly larger, with steep sides and a concave base and was 0.81m wide 0.21m deep. Its fill (6108) produced a worked flint.
- 4.13.11 Pit 6114 was recorded in plan at the south-west end of the trench and extended beyond the excavated area. Other possible features were also investigated but determined to be of natural origin (6105, 6111, 6112, 6115).
- 4.13.12 **Trench 62** was situated adjacent to Trench 61 and was targeted on the north-east side of the annular cropmark. As in Trench 61, a shallow feature was observable in section. Approximately 4m from the south-west end of

the trench, the ditch was approximately 2.5m wide and 0.08m deep and contained a single fill of greyish brown clay silt (6209).

- 4.13.13 At the north-east end of the trench was NNW–SSE aligned ditch 6203. The ditch corresponded with the same historic field boundary as ditches 5103 and 4704. Its upper fill (6205) produced burnt stone and fragments of glass of 19th-/20th-century date. It truncated a small undated pit (6206) on its eastern side.
- 4.13.14 **Trench 63** was positioned to the east of Trench 62 and revealed a single small pit (6303). The pit measured 0.53m in diameter and 0.19m deep and had been backfilled with a dump of clay silt containing large amounts of burnt clay (6304), but no dating evidence.

#### 4.14 Trenches 64, 66, 69, 70 and 72-5 (Figs 27 and 28)

- 4.14.1 This group of trenches were positioned further to the east and closer to the A13. Several of the trenches were targeted on a group of three parallel linear cropmarks and several large discrete features.
- 4.14.2 **Trench 64** lay along the northern boundary of the land parcel, east of Trench 40 and north of Trenches 65 and 66. It contained three ditches and a posthole.
- 4.14.3 Ditches 6411 towards the west end of the trench and ditch 6408 towards the east end were both aligned NNW-SSE some 16.5m apart. Ditch 6411 was 0.85m wide and 0.28m deep with gently sloping sides and a cupped base. The single fill (6412) was a brownish grey clayey sand and occasional stones, but no finds. Ditch 6408 was 0.73m wide and 0.21m deep, and had sloping sides and a flat base. There were two fills, the lower one (6410) a greyish brown clayey silt with lenses of silty sand, the upper fill (6409) a dark greyish brown clayey silt from which flint, burnt flint and animal bone were recovered. Environmental sample <S30> was taken from this fill, and produced a single charred grain, possibly oat, and weed seeds including speedwell and dock and a few small charred legumes.
- 4.14.4 Just west of ditch 6408, and converging with it towards the north, was ditch 6403, which was aligned NNE-SSW. This was 0.55m wide, 0.33m deep and V-profiled with steep sides and a narrow flat base. There were two fills, the primary fill (6405) a greyish brown clayey silt with frequent lenses of sandy silt, the upper fill (6404) a dark greyish brown clayey silt with occasional charcoal that contained struck flint and burnt flint and a sherd of Roman pottery in the top.
- 4.14.5 Ditch 6404 was cut by a shallow small pit or posthole 6406 measuring 0.52m across and 0.12m deep, with steep sides and a flat base, and a single fill (6407) similar to the upper fill of the adjacent ditch (6404). No finds came from this feature. A natural feature (6413) was also partly exposed at the west end of the trench.
- 4.14.6 **Trench 66** was located to the north-west of the group and targeted the easternmost of the three linear cropmarks (6604). The ditch had a shallow concave cut and was filled by a single deposit of greyish brown clay sand (6605).

- 4.14.7 A second ditch (6602) was recorded to the east on a NW–SE orientation. It was steep sided and measured 0.82m wide and 0.24m deep. The primary fill was a silty gravel deposit (6606) and was overlain by a fill (6603) comprising stony clay sand.
- 4.14.8 **Trench 69** was positioned south-west of Trench 66 and targeted the other two linear cropmarks. However, the only feature was a single sub-rectangular pit (6903) at the north-east end of the trench. Pit 6903 contained a fill of greyish brown clay sand (6904), which produced a single flint flake.
- 4.14.9 **Trench 70** lay immediately to the east of Trench 69 and also revealed just a single isolated pit (7005) filled with naturally silted deposit of silty clay. No dating evidence was recovered from this feature. Several other possible pits were also investigated but were not thought to be of archaeological origin (7003, 7004, 7007, 7008).
- 4.14.10 **Trench 72** was targeted on a cluster of discrete cropmark features to the south of Trench 69. At the south-west end it revealed a small sub-circular undated pit (7203). To the west of this, coinciding with one of the cropmarks, was larger pit 7207. Pit 7207 was irregular in shape and measured at least 1.48m long and 0.9m wide. The base of the pit was not exposed due to its depth, but it was more than 0.42m deep. It contained a sequence of four naturally silted deposits, none of which contained any finds.
- 4.14.11 Pit 7207 was cut by ditch 7205, which extended on a broadly E–W alignment with a slightly sinuous shape in plan. It had moderately steep sides and a rounded base with a single fill comprising orange-brown sandy silt (7206). A small quantity of very abraded pottery of either early Neolithic or middle Bronze Age to Iron Age date was recovered from this deposit, together with a single fragment of animal bone. Based on the projected alignment of this ditch, it is possible that it is the same feature as 4405 in Trench 44.
- 4.14.12 **Trench 73** was located south of Trench 72. Near the north-west end of the trench was a concentration of features corresponded with the location of one of the many discrete cropmarks in this Land Parcel. The earliest feature in this sequence was ditch 7305. It was orientated broadly N–S with steep sides and a flat base and was 0.44m wide and 0.29m deep. It contained a naturally silted fill (7306). It was recut along its eastern edge by ditch 7307. This later feature had a broader and shallow profile and was 2.22m wide and 0.25m deep and had also silted up through natural processes. No finds were recovered from this feature. A steep-sided small pit or posthole (7309) was recorded cutting through ditch 7307. This feature was only observed in section and continued beyond the excavated area. A second larger pit (7303) cut the north-west edge of ditch 7305. Pit 7303 was filled with a dark grey-brown silty clay (7304) but contained no dating evidence.
- 4.14.13 Ditch 7311 was located to the south-east and corresponded with a linear cropmark feature on a NNW–SSE alignment. Excavation of the feature revealed a ditch terminus with a single naturally silted fill (7312) from which a single sherd of early Roman (AD 1–150) pottery was recovered.

4.14.14 **Trenches 74 and 75** were positioned to the north-east of Trench 73. They revealed three similar pits (7403, 7503 and 7505). The only find recovered from the features was a flint flake from fill 7506 of pit 7505. Although their function is unclear, it is possible they had a similar purpose and date.

#### 4.15 Trenches 68, 71, 76, 82, 89, and 90 (Figs 29 and 30)

4.15.1 This group of trenches were located near the centre of the site, close to the A13.

4.15.2 **Trench 68** revealed NNW–SSE aligned ditch 6802. This feature is positioned in the same location and orientation as a historic field boundary mapped on the 1st edition OS map. The dark grey silt upper fill produced an iron object of post-medieval/modern date, confirming that this was a relatively modern boundary ditch.

4.15.3 **Trench 71** was located to the south-west of Trench 68. It was targeted on a large discrete cropmark which appears to have been caused by pit 7103. Extending beyond the limits of the excavation the pit measured at least 2.22m in diameter and 0.42m deep. It was filled with a grey-brown silty sand deposit (7102), which produced small fragments of abraded possible Iron Age pottery and prehistoric worked flint.

4.15.4 **Trench 76** also revealed a large pit (7603), located just over 22m to the south-east of 7103. Pit 7603 measured 2.2m long, at least 1.65m wide and in excess of 0.5m deep, although the base was not reached during excavation (Plate 10). It contained a dump of charcoal rich material (7604), which had been introduced from the southern edge. This was then sealed by deposit greyish yellow sand (7605) which appears to have accumulated naturally. Fill 7604 contained seven sherds of Anglo-Saxon pottery dating to c 400–750, together with residual prehistoric worked flint and Roman pottery. Fill 7605 produced further fragments of residual Roman pottery and prehistoric flints. Bulk soil sample 25, collected from fill 7604, contained a large quantity of charcoal and smaller amounts of charred cereal grains (barley and possible wheat) and weed seeds.

4.15.5 The central upper portion of the pit appeared to have been truncated by later feature 7615. Pit 7615 was ovoid in plan and just 0.24m deep with a concave longitudinal profile. Its fill (7606) comprised a greyish yellow silty sand and also incorporated charcoal flecks towards the base, which had presumably derived from the truncation of deposit 7404. It also contained sherds of residual Roman pottery and Roman CBM fragments.

4.15.6 At the northern end of the trench were two narrow ditches (7608 and 7610). They were broadly parallel to each other and less than 0.1m apart, on ENE–WSW alignments. Both ditches had shallow concave profiles less than 0.14m deep and were filled with greyish brown silty sand deposits without finds. A small undated pit or posthole (7612) was recorded in the space between the two in the north-east corner of the trench.

4.15.7 **Trench 82** was positioned near the northern edge of the site and exposed pit or large posthole 8202. It had steep sides and a rounded base and was 0.58m in diameter and 0.38m deep. Filling the pit were two sandy clay

deposits (8204 and 8205). The surface of the feature was truncated by a small shallow cut 8206. No finds were recovered from either feature.

- 4.15.8 **Trench 89** revealed just a small portion of a feature at its south-west end. Only partially exposed and not relating to any cropmarks, it remains unclear whether 8902 was part of a ditch or another large pit. Medieval pottery dating to the 11th to early 13th century was recovered from its single fill (8903), alongside residual early/middle Roman pottery and Roman CBM. A fragment of whetstone was also recovered from the surface of this feature.
- 4.15.9 **Trench 90** was located east of Trench 89. It revealed a single ENE–WSW aligned ditch (9002). It measured almost 1.5m wide and just 0.13m deep with a sterile fill of dark grey-brown silty clay. No adjacent trenches revealed similar features on this alignment and there is no corresponding cropmark.

## 4.16 Trenches 78, 105-6 and 112-14 (Figs 31 and 32)

- 4.16.1 This group of trenches were positioned near the middle of the site, close to Stanford Road and opposite Whitecroft's Farm. The cropmarks for this area of the site indicated numerous discrete features and a linear feature that probably corresponds to a historic field boundary.
- 4.16.2 **Trench 78** was located approximately 20m south of Trench 75. Towards the northern end of the trench was large WNW–ESE aligned ditch 7802. It had moderately steep sides and a flattish base and was 1.9m wide and 0.45m deep. It contained a primary slump of material (7808), comprising light grey silty clay, overlain by an orange-brown silty clay (7809). The final upper fill was a deposit of greyish brown silty clay (7803) and produced a small quantity of Roman pottery. The deposits reflect a process of gradual natural silting.
- 4.16.3 Truncating the southern edge of the ditch was pit 7804. This feature was particularly difficult to see but consisted of a slightly irregular cut filled with a slump deposit of gravelly clay (7810), overlain by a sterile deposit of greyish brown silty clay (7805).
- 4.16.4 Near the southern end of the trench was unusual, narrow linear feature 7806. Initially interpreted as a ditch, this is perhaps more likely to be a result of bioturbation.
- 4.16.5 An area of greyish brown silty clay was investigated at the northern end of the trench and interpreted as a patch of natural silting (7811). It corresponds with a discrete cropmark but in the absence of any archaeological material to suggest otherwise, it is believed that the cropmark is derived from a geological variation.
- 4.16.6 **Trench 105** was located to the east of Trench 78. It revealed NNW–SSE aligned ditch 10502. The position and orientation of this ditch matches both a linear cropmark and a field boundary recorded on the 1st edition OS map. Recovery of iron objects and CBM confirm a post-medieval/modern date for this ditch.
- 4.16.7 **Trench 112** was positioned to the south of Trench 105 and located the same cropmark field boundary (11202). A small quantity of Roman pottery was recovered from its single fill (11203). At the southern end of the trench this was truncated by perpendicular ditch 11206. Ditch 11206 contained a



single fill (11207), which produced Roman pottery and the remains of a near complete calf skeleton. Due to the level of preservation, it is likely that the pottery is residual and the faunal remains are more recent than the Roman period.

- 4.16.8 In the northern half of the trench was L-shaped ditch 11204. It had a shallow concave profile and was 1.17m wide and 0.16m deep with a fill of brownish grey clay silt (11205). No finds were recovered from this ditch and no clear relationship with 11202 could be established.
- 4.16.9 **Trench 106** was located a little more than 25m to the north-east of Trench 112. At the eastern end of the trench an irregular, curvilinear feature was excavated in two places (10604 and 10602). It was a shallow, steep-sided feature with a wide flattish base, up to 0.74m wide and 0.27m deep. The fill was a grey-brown silty clay deposit (10605) that contained a sherd of middle Bronze Age to Iron Age pottery. The unusual form of the feature made it difficult to determine its original function. It was perhaps a tree-throw hole but could be part of an irregular, truncated curvilinear ditch.
- 4.16.10 **Trench 113** revealed a pair of small intercutting pits (11302 and 11305). Pit 11302 contained two fills (11303 and 11304). Upper fill 11304 was a dark grey-brown silty clay, with frequent fragments of charcoal and a large stone, suggesting this was a deliberate dumped deposit, though it did not produce any finds. Soil sample 3, collected from fill 11303, produced just a small amount of charcoal. The pit was truncated to the east by pit 11305, which contained a single undated fill (11306).
- 4.16.11 **Trench 114** was located to the east of Trench 113 and adjacent to a row of houses referred to as Five Chimneys on historic mapping. At the northern end of the trench was undated ditch 11402, orientated ENE–WSW, which contained only a few pieces of animal bone. To the south was a second ditch (11404). It measured 1.7m wide and 0.31m deep with gently sloped sides and a flat base. It contained a grey-brown, silty clay fill (11405) which produced a piece of animal bone.
- 4.16.12 Ditch 11404 coincides with the northern end of a structure mapped on the 1st edition OS map that was no longer extant on the site. Although no structural material was recovered from the ditch, it is possible that this was a robber trench to remove the foundations of the structure.

## 4.17 Trenches 98-100 and 108 (Figs 33 and 34)

- 4.17.1 This group of trenches were situated to the north of the Five Chimneys residential dwellings.
- 4.17.2 **Trench 98** was located at the west of the group. In the south-east end of the trench was possible ditch terminus or pit 9802. It measured 0.88m wide and 0.24m deep with a fill of orange-brown sandy clay which produced a single flint flake.
- 4.17.3 Near the centre of the trench were two adjacent pits or perhaps two ditch terminals forming an entrance (9804 and 9806; Plate 11). They were very similar in appearance with steep sides and slightly concave bases, approximately 1m wide and 0.3m and 0.42m deep. Both features were filled by deposits of greyish brown sandy clay (9805 and 9807). Pit 9804 also

contained fragments of middle Bronze Age to Iron Age pottery and prehistoric worked flint, and pit 9806 produced prehistoric worked flint.

- 4.17.4 **Trench 99** was located to the east of Trench 98 and revealed a single undated posthole (9902) at the southern end of the excavated area as well as a natural feature (9904).
- 4.17.5 **Trenches 100 and 108** were situated to the east of Trench 99 and both revealed what is believed to be the same slightly sinuous NW–SE aligned ditch (10003 and 10802). Deposit 10004 from ditch 10003 contained both prehistoric worked flint and middle Bronze Age to Iron Age pottery, but no finds were recovered from the feature in Trench 108. It had moderately steep sides and flattish base up to 0.77m wide and 0.3m deep. Due to its alignment, it was not identified in any adjacent trenches and does not correspond to any cropmark features plotted in this field.

## 4.18 Trenches 83-6 and 92-3 (Figs 35 and 36)

- 4.18.1 This group of trenches were positioned towards the north-east corner of Land Parcel 30, adjacent to the A13.
- 4.18.2 **Trench 83** was located to the west of this group. Ditch 8302 was recorded near the north-west end of the trench with a ENE–WSW alignment. It had a broad shallow profile, 2.1m wide and 0.3m deep, containing naturally accumulated fills 8303 and 8304. The upper fill (8304) produced two small sherds of Roman pottery. Ditch 8305 was located along the northern edge of ditch 8302, on a parallel alignment. Due to the similarity of their fills, no relationship could be determined. A tiny fragment of undated pottery was recovered from the fill of ditch 8305 (8306).
- 4.18.3 Elongated ovoid pit 8307 was excavated to the south of the ditches. Due to its irregular profile, it is more likely to be a tree-throw hole than an archaeological feature. No finds were retrieved from its fill.
- 4.18.4 **Trench 84** was excavated to the north-east of Trench 83. It revealed two ditches and a pit. Large NNW–SSE ditch 8406 measured 2.38m wide with steep sides leading to a broad concave base and was 0.7m deep (Plate 12). At the base of the ditch was a primary deposit of silty clay (8408) including flecks of fired clay, overlain by a naturally silted layer of silty clay (8407).
- 4.18.5 Located several metres to the east was a second ditch on a parallel alignment (8404). It was 0.64m wide with a shallow undulated base 0.07m deep. It was filled with a deposit of orange-brown silty clay but contained no artefacts.
- 4.18.6 Pit 8402 was situated immediately to the east of ditch 8404. The shape in plan and profile were both slightly irregular and it measured 1.92m wide and 0.52m deep. It was filled with a deposit of grey-brown silty clay (8403) and yielded a piece of worked flint.
- 4.18.7 **Trenches 85, 86 and 92** were adjacent to each other over a distance of approximately 100m near the northern edge of Land Parcel 30. They each appeared expose parts of the same NE–SW aligned ditch running across this part of the site (8502, 8602, 9202). It had a consistently shallow

concave profile, between 0.56 and 0.73m wide and up to 0.22m deep. It was filled by a single naturally accumulated deposit that was devoid of finds.

- 4.18.8 In Trench 85, a small undated pit (8504) was excavated alongside the ditch.
- 4.18.9 **Trench 93** was positioned to the south of Trench 85. It revealed NNW–SSE aligned ditch 9307. It had steep sides and an undulating flattish base and was 1.85m wide and 0.4m deep. Filling the ditch was a single deposit of sandy clay (9308), which produced a small amount of Roman pottery.
- 4.18.10 Near the eastern end of the trench were two slightly irregular pits (9304 and 9302). Pit 9302 was almost 2m wide and 0.36m deep. It contained a fill of reddish-brown silty sand (9303) that was particularly difficult to differentiate from the geology. Several small sherds of middle Bronze Age to Iron Age pottery and a prehistoric worked flint were recovered from the fill. Pit 9304 was very similar in appearance, with two fills (9305 and 9306). No finds were recovered from pit 9304.

#### 4.19 Trenches 87-8, 95-96, 102-4 and 111 (Figs 37 and 38)

- 4.19.1 This group of features were positioned at the eastern end of Land Parcel 30.
- 4.19.2 **Trench 88** was in the north-east corner of the site. Pit 8802 was only partially exposed, as it extended to the north beyond the limits of the trench. Ovoid in plan, it measured 1.14m wide and 0.45m deep. It contained a primary fill of brown clay silt (8804), overlain by a deposit of grey-brown clay silt (8803). Both fills produced finds of early Neolithic pottery and worked flint.
- 4.19.3 **Trench 87** lay west of Trench 88, and contained two soilmarks, one a patch of natural soil, the other a tree-throw hole 8703, whose reddish-grey silty clay fill produced two struck flints: a flake and a blade.
- 4.19.4 **Trench 95** was located approximately 20m south-west of Trench 88. It revealed a single undated ditch 9502. Orientated NNW–SSE, it was filled by a deposit comprising grey-brown silty clay (9503). It was not observed in any of the adjacent trenches.
- 4.19.5 **Trench 96** was located east of Trench 95. Ditch 9607 was recorded in the southern half of the trench on a WSW–ENE alignment. It had steep sides and an irregular base with a single fill of brown sandy silt (9608). A small amount of possible late Bronze Age/Iron Age pottery and prehistoric worked flint were recovered during excavation.
- 4.19.6 The large tree-throw hole (9609) to the north of ditch 9607 also contained a small amount of very abraded pottery of either early Neolithic or middle Bronze Age to Iron Age date from secondary fill 9610.
- 4.19.7 Several natural features were also observed and investigated in this trench (9605, 9606, 9612). It is unclear if undated possible pit 9603 was archaeological or natural in origin.
- 4.19.8 **Trench 102** revealed small irregular pit 10203 at its western end. It measured 0.9m in diameter and 0.18m deep with a rounded base. It contained an initial fill of yellow grey silt clay (10204) onto which a dump of burnt waste had been dumped (10205), rich in charcoal and with a large

quantity of oxidised material. No dating evidence was hand collected from this pit. However, a very small and abraded sherd of possible Iron Age pottery was recovered from bulk soil sample 22, collected from deposit 10205. This sample also contained a small amount of charcoal, but no charred plant remains.

- 4.19.9 **Trench 103** was located east of Trench 102. Two possible ditches (10305 and 10307) were recorded in this trench, but they may have been remnant subsoil deposits that survived in a depression caused by a change in the underlying geology. Similarly, pit 10302 was in fact a naturally silted manganese-rich deposit and not an archaeological feature.
- 4.19.10 **Trench 104** was situated in the south-east corner of the site, east of Trench 103. It revealed large shallow pit 10404 (Plate 13). Approximately 1.89m wide and 0.22m deep, it was filled a deposit of brownish grey clay sand (10405). A substantial assemblage of nearly 100 sherds of medieval pottery dating to c 1270–1350 were also recovered, clustered together on the base of the pit (Plate 14), as well as more than 50 small fragments of very eroded animal bone.
- 4.19.11 To the north-west of the pit was NW–SE aligned ditch 10406. It had a shallow concave profile, 0.24m and a fill of greyish brown sandy clay (10407). A small sherd of Roman pottery was recovered from this ditch.
- 4.19.12 Further to the north-west was a natural feature (10403) from which small quantities of Roman pottery and eroded animal bone were retrieved.
- 4.19.13 **Trench 111** was positioned to the south-west of Trench 104, adjacent to Stanford Road. It revealed shallow undated ditch 11106, truncated by a parallel adjacent ditch 11104 (Plate 15). The later ditch was filled with a naturally silted sequence of fills, with a final upper fill (11105). Small posthole 11102 was recorded cutting through deposit 11105, but due to the mottled nature of the deposits, this could be a misinterpretation of the sediments.
- 4.19.14 Ditch 11110 was a small feature just 0.36m wide and 0.04m deep. It contained an undated fill of brown silty clay.

## 4.20 Trenches 1, 5-7, 14-15 and 17 (Figs 39 and 40)

- 4.20.1 This group of trenches were located in the western part of Land Parcel 35, east of Rectory Road and north of the A13. They were predominantly positioned to target a number of rectilinear cropmark features.
- 4.20.2 **Trench 1** was located in the north-west corner of the site in one of the areas devoid of cropmarks. At the south-west end of the trench was a narrow ditch (109). It measured 0.41m wide and 0.09m deep and was filled with a deposit of reddish-brown sandy silt. No finds were recovered from this feature.
- 4.20.3 Ditch 111 was situated a few metres to the east of ditch 109, on a parallel NNW–SSE orientation. It had a broad flat base and was 1.28m wide and 0.25m deep. It contained a primary fill of stony sand (113) overlain by a slowly accumulated sandy silt (112). Fill 112 produced two joining fragments of Roman tile.

- 4.20.4 Ditch 114 was only visible in section, adjacent to ditch 111. It had a shallow flat profile and a single undated fill (115).
- 4.20.5 Towards the north-east end of the trench was a row of three postholes (107, 105 and 103), aligned NE–SW (Plate 16). Each measured approximately 0.3m in diameter. They survived to between 0.09 and 0.22m deep. Deposit 104 from posthole 103 contained a small amount of post-medieval pottery and was the only one to yield any finds.
- 4.20.6 **Trench 5** was situated just over 70m to the south-east of Trench 1. It revealed E–W aligned ditch 503 near the centre of the trench. The shallow concave feature contained a deposit of greyish brown silty sand (504) from which animal bone fragments and post-medieval CBM were recovered. This ditch was closely aligned with a linear cropmark feature mapped close to this location.
- 4.20.7 Ditch 505 was recorded in plan at the northern end of the trench. Unexcavated at this location, its alignment suggested it was the same feature as ditch 604 in Trench 6.
- 4.20.8 **Trench 6** was located to the north-east of Trench 5 and contained ditch 604. It measured 1.64m wide and 0.48m deep with a fill of grey-brown silty clay and stones (605). No finds were recovered from the fill.
- 4.20.9 Near the centre of the trench and extending beyond the western baulk was sub-circular pit or tree-throw hole 607. It was filled with naturally accumulated sediments 608 and 609. The upper fill (608) contained several pieces of worked flint which had clearly been dumped in this feature.
- 4.20.10 **Trench 7** targeted a NNW–SSE aligned linear cropmark to the east of Trench 6. Two ditches (709 and 711) were revealed at the eastern end of the trench on this alignment. Based on its position, ditch 709 is mostly likely to have created the cropmark targeted. It measured 0.66m wide and 0.16m deep. It contained a primary fill (714) overlain by reddish grey sand silt deposit (710). Several fragments of post-medieval CBM were recovered from deposit 710.
- 4.20.11 Ditch 711 had steep sides and was 0.81m wide and 0.32m deep. It was filled with a greyish brown silty sand (713), overlain by a deposit of reddish grey sandy silty (712). Both deposits contained fragments of post-medieval CBM, whilst two sherds of early post-medieval pottery were also recovered from deposit 712.
- 4.20.12 In the south-west end of the trench were two undated pits or possible postholes (703 and 707), both measuring approximately 0.4m in diameter and 0.1m deep (Plate 17). In between these two was a third discrete feature (705). It measured 0.51m wide and just 0.06m deep. It is unclear if this was also originally a posthole or a pit. A single sherd of Roman pottery was recovered from deposit 706, the fill of feature 705.
- 4.20.13 **Trench 14** was located to the south of Trench 7. It revealed NNW–SSE aligned ditch 1403. It measured 0.85m wide and 0.3m deep with steep sides and a flattish base. Filled with a single deposit silty sand (1404), no finds were recovered from this ditch. Ditch 1403 corresponds with a rectilinear cropmark feature which indicates that it was the same ditch at 803 to the north-east and 1507 to the south. Although not connected by the

cropmarks, the orientation and profile of the ditch may also indicate that was a continuation of ditch 709 to the north.

- 4.20.14 **Trench 15** revealed three parallel ditches (1503, 1505 and 1507). Ditch 1507, at the western end of the trench, had a concave profile and was 0.98m wide and 0.24m deep. It was filled with a single sterile deposit (1508).
- 4.20.15 Ditch 1505 was located approximately 9m to the north-east. It had a shallow concave profile and was 0.54m wide and 0.17m deep with a naturally silted dark grey-brown silty sand fill (1506). Less than 0.2m to the north-east was ditch 1503, which measured 0.8m wide and 0.18m with a similar fill to 1506.
- 4.20.16 No dating evidence was recovered from any of these ditches, but their correlation to the cropmark evidence does indicate that they were part of the rectilinear enclosure system present here.
- 4.20.17 **Trench 17** was located to the south-east of Trench 5. It revealed a large ditch aligned ENE–WSW (1704). Ditch 1704 was only visible in the section of the trench, an appeared to be cut through the subsoil (1701) and had not been clearly identified during stripping. It measured 1.38m wide and 0.48m deep, with a concave base. It was filled with a single orange-brown silty sand (1705) and produced a small amount of presumably residual late Bronze Age pottery.
- 4.20.18 Also recorded in section and apparently cutting the subsoil was a pit or posthole (1706). It had a width of 0.41m and near-vertical sides, 0.5m deep. Its fill of dark grey-brown silty sand (1707) included both middle Bronze Age to Iron Age pottery and CBM fragments.
- 4.20.19 Although layer 1701 appeared to be a subsoil deposit, subsoil was absent from many of the trenches and the features recorded were usually sealed by this layer. Unless the features in Trench 17 were post-medieval in origin, it is more likely that layer 1701 is a change in the natural geology.

## 4.21 Trenches 8-11, 13 and 22 (Figs 41 and 42)

- 4.21.1 This group of trenches were located near the centre of the parcel, targeting the densest area of rectilinear cropmark features.
- 4.21.2 **Trench 8** revealed a single ditch (803), which the cropmarks indicated was probably linked to ditch 1403 to the south-west. Ditch 803 had steep sides and a wide concave base and was 1.28m wide and 0.38m deep. Its single fill consisted of sterile, greyish brown silty sand (804).
- 4.21.3 **Trench 9** was located to the north-east of Trench 8. It revealed a pair of parallel ditches aligned NNW–SSE at opposing ends of the trench (903 and 905). The ditches both had shallow concave profiles and sterile naturally silted fills. Both ditches also appeared to be related to similarly aligned cropmarks.
- 4.21.4 **Trench 10** was positioned to the south of Trench 9 targeting adjacent cropmark features. Ditch 1003 was recorded near the south-west end of the trench, corresponding to a NNW–SSE aligned cropmark. The ditch measured 0.72m wide and 0.16m deep. It was filled by sterile sandy silt deposit 1004.

- 4.21.5 At the north-east end of the trench, pit or ditch 1005 was recorded in plan extending beyond the limits of the excavated area. Broadly E–W aligned, it is likely that this was part of a corresponding linear cropmark. It may have been parallel to and contemporary with feature 1007, a small ditch recorded in section to the west of ditch 1005. No finds were recovered from either of these features.
- 4.21.6 **Trench 11** was located to the east of Trench 10 and revealed two features. Ditch terminus/pit 1105 was recorded at the northern end of the trench. It had a shallow, wide concave profile and was 0.58m wide and 0.1m deep and contained a naturally accumulated deposit (1106). Based on its position and nearby cropmarks, it is possible that this was the continuation of ditch 1005 in Trench 10.
- 4.21.7 Ditch 1103 was another undated feature with a shallow concave profile. Also corresponding with a cropmark feature, its NE–SW orientation is distinct from the majority of enclosure ditches recorded on this site and perhaps representative of a different phase of activity.
- 4.21.8 **Trench 13** targeted three linear cropmarks that were revealed as ditches 1303, 1305 and 1307. Each had a shallow concave profile and they were filled with slowly accumulated sterile deposits. Extrapolating the alignments, it is likely that 1303 formed part of the same boundary as ditch 1003 to the north. With ditches 1303 and 1305 on a perpendicular alignment to 1307, they appear to have been part of the same enclosure system.
- 4.21.9 **Trench 22** was located to the south of Trench 13 and recorded a ditch (2206) that was probably the continuation of ditch 1303 or 1305 from Trench 13. At this location it had steep sides and broad flattish base and was 1.18m wide and 0.24m deep but was also filled with a sterile undated deposit (2207). To the east of ditch 2206 was small possible posthole 2203. It measured 0.3m in diameter and contained brownish grey, silty sand deposit. Alternatively, it could have been part of adjacent animal burrow 2205.

## 4.22 Trenches 24-5, and 27 (Figs 43 and 44)

- 4.22.1 This group of trenches were located in the south-east corner of Land Parcel 35. They were targeted on a penannular cropmark and other rectilinear cropmarks north of the A13.
- 4.22.2 **Trench 24** revealed single ditch 2403. It had a shallow concave profile and was 0.94m wide and 0.14m deep with a fill of grey-brown silty sand (2404). Aligned NE–SW, it matches one of the linear cropmarks targeted by the trench. The second targeted cropmark may have passed to the south of the trench.
- 4.22.3 **Trench 25** was an L-shaped trench targeting perpendicular linear cropmarks. At the west end of the trench, ditch 2507 was revealed. The full depth of the ditch was not exposed, but it was 1.22m wide and at least 0.44m deep. The upper fill (2508) comprised grey-brown silty sand and included fragments of 18th/19th-century CBM and wood fragments. The finds recovered suggest a recent date, and although it matches a cropmark

feature. There was no ditch mapped at this location on the 1st edition OS map.

- 4.22.4 Ditch 2503 had a steep side and a flat base, filled with greyish brown silty sand (2504). It was recut to the east by ditch 2505 which also had steep sides and a flattish base. It was filled by a similar, but darker deposit (2506). Neither ditch produced any finds.
- 4.22.5 **Trench 27** was located to the north of Trench 26, which had failed to identify anything that related to a penannular cropmark.
- 4.22.6 Ditch 2703 was recorded near the centre of the trench and corresponded with a cropmark feature with an ENE–WSW alignment. It had a concave profile and contained sterile naturally accumulate fill 2704.

## 4.23 Trenches 31-35 (Figs 45 and 46)

- 4.23.1 The group of trenches was situated in the north-east corner of the site. They were principally focused on the southern edge of a rectilinear enclosure cropmark.
- 4.23.2 **Trench 31** revealed several features relating to cropmarks. Ditch 3105 at the south-west end of the trench was a NNW–SSE aligned ditch, 1.3m wide and 0.34m deep, with steep sides and a narrow concave base (Plate 18). It contained two fills of naturally silted material, 3106 and 3107, neither of which produced any finds.
- 4.23.3 Ditch 3103 was located near the centre of the trench. The extent of this feature was difficult to define, but it appeared to be a gently sloped, rounded ditch terminus extending beyond the south-east baulk of the trench. Less than 0.2m deep, it contained a single fill of sterile light brown silty sand (3104).
- 4.23.4 At the north-east end of the trench was ditch 3109. It had steep sides and a rounded base and was 1.3m wide and 0.36m deep. Primary fill 3110 contained a sherd of 13th- to 15th-century pottery. The overlying deposit of reddish-brown silty sand (3111) was devoid of finds.
- 4.23.5 **Trench 32** revealed the very shallow remnants of NE–SW aligned ditch 3203. Just 0.07m deep and cut into sandy gravel geology, it was difficult to determine the relationship with perpendicular ditch 3205, but it appeared that 3205 was possibly the later feature. Based on the associated cropmarks, it would seem that ditch 3205 was part of a subdivision within a larger enclosure defined to the south by ditch 3203. No finds were recovered from either feature.
- 4.23.6 **Trench 33** revealed ditch 3303, which potentially forms a continuation of ditch 3203 from ditch 32. Ditch 3303 measured 0.86m wide with moderately sloped sides and a concave base 0.18m deep. It contained a primary fill (3306) overlain by a deposit of dark grey silty sand (3305) and a final upper fill of brown-grey silty sand (3304). Deposit 3304 contained several sherds of Roman pottery. Soil sample 1, collected from fill 3304, produced charcoal and charred cereal grains of wheat and oat, chaff and weed seeds.
- 4.23.7 **Trench 34** was located to the east of Trench 33. At the east end of the trench small pit or posthole 3403 was recorded. It contained a moderate



amount of charcoal suggesting the fill (3404) had been dumped into the feature, but no finds were recovered.

- 4.23.8 Adjacent to feature 3403 was NNW–SSE aligned ditch 3405. The shallow concave profile was filled with a sterile deposit of reddish-brown sandy silt (3406).
- 4.23.9 **Trench 35** was located to the south of Trench 34 and exposed narrow NE–SW aligned ditch 3503. It measured 0.5m wide and 0.14m deep and was filled with reddish brown silty sand devoid of artefacts.

## 4.24 Trenches 195, 198, 200 and 202 (Fig. 47)

- 4.24.1 The group of trenches was situated towards the north-east corner of the site in the west end of Land Parcel 103.
- 4.24.2 **Trench 195** was located at the north edge of the site and to the north of Trenches 197 and 198, and exposed two ditches (19502 and 19504), both aligned broadly NNW-SSE. Ditch 19502 was situated in the eastern half of the trench, measured 1.15m wide and 0.13m deep and had a single grey sandy silt fill devoid of artefacts. The other ditch (19504) was located at the western end of the trench and was 1.32m wide, but was not excavated.
- 4.24.3 **Trench 198** was located to the south of Trench 195 and to the west of Trench 202, and also exposed two ditches (19803 and 19805) aligned NNW-SSE. These ditches were broadly in line with ditches 19504 and 19502 to the north, and probably represent continuations of the same boundaries.
- 4.24.4 Ditch 19803 was exposed at the western end of the trench. It measured 1.8m wide and 0.44m deep, and had a single fill (19804) that was devoid of finds.
- 4.24.5 Ditch 19805 crossed the centre of the trench and was measured 4m wide and 0.3m deep. It contained three greyish brown silt-clay fills, all without finds.
- 4.24.6 **Trench 200** was located to the south-west of Trench 198 and to the west of Trench 201 and exposed a single ditch (20003), also on a NNW-SSE alignment.
- 4.24.7 Ditch 20003 measured 0.67m wide and 0.26m deep, and contained a single greyish brown silty sand fill devoid of artefacts. No continuation of this ditch was seen in Trench 194 to the north, although it is possible that the ditch may continue just beyond the east end of the trench.
- 4.24.8 **Trench 202** was located to the east of Trenches 195 and 198 and to the west of Trench 204. It exposed a single ditch (20202) at the northern end of the trench.
- 4.24.9 Ditch 20202 was aligned ENE-WSW and measured 1.8m wide and 0.5m deep and contained three fills. The earliest fill (20203) was an orange-brown sandy silt. Above this, fill 20204 was a yellow-brown sandy silt that produced iron nail fragments, while the upper fill (20205) was a grey-brown clay-silt containing a copper alloy handle of 19th or early 20th century date, bottle and window glass of 20th century date and a fragment of a further

probable nail. The projected line of this ditch crossed Trench 197 to the west, but no continuation was seen.

#### 4.25 Trenches 207-8 and 211-13 (Fig. 48)

- 4.25.1 This group of trenches lay in the centre of Land Parcel 103, some way east of Trench 202.
- 4.25.2 **Trench 207** was located to the south of Trench 206 and to the east of Trench 205 and exposed two ditches (20703 and 20705).
- 4.25.3 Ditch 20703 was aligned NE-SW and measured 0.74m wide and 0.1m deep. It contained a single greyish brown silty clay fill (20704) devoid of artefacts. No continuation of this ditch was seen in Trench 208 on its projected line to the north-east.
- 4.25.4 Ditch 20705 was situated to the west of ditch 20703 on an ENE-WSW alignment. It measured 0.44m wide and 0.1m deep and contained a single light greyish brown silty clay fill devoid of artefacts. No continuation of this ditch was seen in Trench 210 on its projected line to the ENE.
- 4.25.5 **Trench 208** was located to the north-east of Trench 207. It exposed a single ditch (20803) aligned NNW-SSE.
- 4.25.6 Ditch 20803 measured 0.88m wide and 0.2m deep. It contained a single light yellowish grey clayey silt fill (20804) that was devoid of artefacts.
- 4.25.7 **Trenches 211 and 213** Two natural features (21103 and 21104) were recorded in Trench 211, and one (21303) in Trench 213.
- 4.25.8 **Trench 212** was located east of Trench 208, to the north-east of Trench 211 and north of Trench 213. It exposed a single ditch aligned NE-SW.
- 4.25.9 Ditch 21203 measured 1.74m wide and 0.4m deep. It was filled with a single brownish-grey sandy silt (21204) devoid of artefacts. No continuation of this ditch was seen in Trenches 209, 210 or 211 to the west.

#### 4.26 Trenches 214-17, 220-4 and 227 (Figs 49 and 50)

- 4.26.1 This group of trenches occupied the eastern part of Land Parcel 103 just north of the A13.
- 4.26.2 **Trench 214** was located to the east of Trench 212 and to the west of Trench 216. It contained a large feature that extended beyond the east and west trench limits (21405) and two narrow linear features (21403 and 21404).
- 4.26.3 Feature 21405 measured 4.35m wide. It was investigated by hand to a depth of 0.32m, although this was not excavated to the base of the feature due to this extending below 1m deep from the existing ground level. The excavated dark brownish grey silty sand fill (21408) also yielded 19th-century pottery, peg tile and animal bone. Features 21403 and 21404 both shared irregular profiles and a firm, dark brownish grey clayey silt fill, and were judged to be of natural origin. Two scraps of post-medieval CBM came from 21406, the fill of 21404, presumably from the top.
- 4.26.4 **Trench 215** was located to the south of Trench 214 and to the west of Trench 217. It exposed a single ditch (21503).
- 4.26.5 Ditch 21503 was aligned NW-SE and measured 0.8m wide and 0.3m deep. It contained a single grey-brown clay silt fill devoid of artefacts.

- 4.26.6 **Trench 216** was located to the east of Trench 214 and to the north-east of Trench 215. It exposed a single ditch (21603).
- 4.26.7 Ditch 21603 was aligned N-S and measured 1.06m wide and 0.12m deep. It contained a single light grey-brown silt clay fill (21604), devoid of artefacts.
- 4.26.8 **Trench 217** was located to the east of Trench 215 and to the south of Trench 216. It exposed a probable quarry pit (21703).
- 4.26.9 Pit 21703 extended beyond the east and western sides of the trench and measured 2m wide. It was only excavated to a depth of 0.5m, and was not bottomed, but it contained a grey-brown sandy silt fill (21704) that produced a single flint flake.
- 4.26.10 **Trench 220** was located to the east of blank Trenches 218 and 219 and exposed two intercutting ditches (22003 and 22005) at its SE end.
- 4.26.11 Ditch 22003 was aligned NW-SE, measuring 0.3m wide and 0.1m deep. It contained a single light greyish brown silty clay fill (22004) devoid of artefacts. Ditch 22005 cut ditch 22003 on a perpendicular alignment (NE-SW) and measured 0.68m wide and 0.15m deep. It also contained a single greyish brown silty clay fill (22006) that was without finds. No continuation of ditch 22005 was seen on its projected line in Trench 222 to the east.
- 4.26.12 **Trench 221** was located to the north-east of Trench 220 and to the west of Trenches 222 and 223. It exposed three ditches (22103, 22105, 22107), all on similar alignments, and a natural feature (22109).
- 4.26.13 Ditch 22103 was located in the central part of the trench, cut into the natural. It was aligned NW-SE and measured 0.94m wide and 0.23m deep. It contained a single grey-brown silt clay fill (22104) that produced pottery of late Iron Age/early Roman date. No continuation was seen on the line of this ditch in Trench 222 to the south.
- 4.26.14 Ditch 22105 was located at the north-east end of the trench and was also aligned NW-SE and cut into the natural. It measured 1.33m wide and 0.3m deep and contained a single greyish-brown silty clay fill (22106), which produced a sherd of late Bronze Age or early Iron Age pottery. No continuation of this ditch was seen in Trench 222 to the south.
- 4.26.15 Ditch 22105 was cut by curvilinear ditch (22107), which was cut through the subsoil (22101) and ran broadly east to west across the trench, measuring 0.54m wide and 0.26m deep. It contained a single brownish-grey silty clay fill (22108) that contained clay pipe of post-medieval date.
- 4.26.16 Ditch 22109 lay at the south-west end of the trench, and its fill (22110) was a light greyish-orange silty clay, from which a flint flake was recovered.
- 4.26.17 **Trenches 222 and 223** only contained natural features.
- 4.26.18 **Trench 224** was located to the east of Trench 223 and to the north of Trench 225. It exposed a ditch (22403) at the eastern end of the trench and a natural feature to its west (22405).
- 4.26.19 Ditch 22403 was aligned NW-SE and measured 0.85m wide and 0.19m deep. It contained a single light brown-grey silty clay fill (22404) devoid of artefacts. No continuation on the projected line of this ditch was found in Trench 227 to the south.

4.26.20 **Trench 227** was located to the south-east of Trench 224 and to the south of blank Trench 226 at the south-east corner of Land Parcel 103. The trench contained a single ditch aligned ENE-WSW (22703). It measured 1.05m wide with very steep sides, and was excavated to a depth of 0.3m, but was not bottomed. It contained a single dark grey-brown silt fill (22704) with a high organic content, suggesting a very recent date, and a sherd of window glass of late 19th/20th century date was found in the fill, but due to the obviously recent date of the ditch, this was not retained. The ditch ran parallel to the A13 to the south, and was probably a boundary ditch alongside the road.

## 4.27 Trenches 228, 230-2 and 235-7 (Fig. 51)

4.27.1 This group of trenches lay at the west end of Land Parcel 107, adjacent to the western arm of Fen Lane, and in the lowest part of the site. The ground in this area lies on the lower slopes of the terrace as it dips northwards into the Mar Dyke valley.

4.27.2 **Trench 228** was situated in the north-west corner of Land Parcel 107, to the east of Fen Lane. This trench had a layer of alluvium (22802) overlying the natural and below topsoil and subsoil (28001). A struck flint was recovered from both the subsoil and the alluvium. There was also a natural feature (22804) below the alluvium at the northern end of the trench, which did not contain finds.

4.27.3 **Trench 230** was situated to the south-east of Trenches 228 and 229. It also had a layer of alluvium (23002) below subsoil, and burnt flint was recovered from this. The trench revealed one ditch in the central part of the trench (23004) and one possible ditch at the western end (23006). Ditch 23004 measured 1.55m wide and 0.27m deep and was aligned N-S (Plate 19). It contained a single blue-grey sandy clay that contained a folded iron strip or bar of uncertain date. Unexcavated ditch 23712 was on the projected line of ditch 23004 to the south, and may have been a continuation, although its alignment was slightly different.

4.27.4 Possible ditch 23006 was also aligned N-S and measured 3.3m wide and 0.4m deep. Its single blue-grey sandy clay fill was also devoid of finds. The edge of this feature was not clearly defined at the west edge of this trench, although it was shallowing, and it is possible that it continued beyond the end of the trench and was a lower layer of alluvium filling a wider hollow. Ditch 23706 recut as 23708 was, however, on the projected line of feature 23006 to the south, and may represent a continuation.

4.27.5 **Trench 231** was situated to the east of Trench 230. Pit 23103 was located in the southern part of the trench. It was sub-circular and measured 0.97m wide and 0.49m deep, with a single fill of light blue-grey sandy clay devoid of finds (Plate 20). There was no alluvium below subsoil in this trench, but a struck flint was recovered from the surface of the natural (23102).

4.27.6 **Trench 232** was situated to the east of Trench 231. Ditch 23203 was located in the central part of the trench and was aligned NE-SW. It measured 0.52m wide and 0.27m deep and contained a single grey-blue silty clay fill (Plate 21) that was devoid of finds.

- 4.27.7 **Trench 235** lay south-west of Trench 230 and was orientated NW-SE. It contained a sequence of alluvial fills and an unexcavated ditch in its south-eastern half. The alluvial fills (23506 over 23505 over 23504) occupied about 10m of the trench (Plate 22), and 23506 was cut by N-S ditch 23507 at its western edge. Alluvium 23506 was a reddish-brown clayey silt 0.33m thick, and struck flint was recovered from its surface. This overlay 23505, which was an orange-brown silty clay stonier version of the overlying fill, and was 0.18m thick, but did not produce any finds. Below this was 23504, a blueish-grey clayey gravel, of which only the upper 0.1m of 23504 was revealed within the trench, as it continued beyond the safe 1m limit to which excavation was allowed. No finds were recovered from this.
- 4.27.8 **Trench 236** did not contain alluvium or archaeological features, but a struck flint was recovered from the subsoil (23601).
- 4.27.9 **Trench 237** was situated south of Trench 235 and east of Trench 236 in the south-western part of Land Parcel 107. A struck flint was recovered from the subsoil (23701), below which was a layer of alluvium (23702). Below the alluvium the trench revealed five ditches, four of which were on the same N-S alignment.
- 4.27.10 At the western end of the trench, ditch 23710 was aligned N-S and measured 1.44m wide and 0.38m deep, with a single fill of blueish-grey sandy clay devoid of finds (Plate 23). Located 2.7m to the east was ditch 23708, which cut an earlier ditch on the same alignment (23706). Ditch 23708 was wide and shallow, measuring 2.19m wide and 0.21m deep. Its single fill was a greyish-blue silty clay devoid of finds. Ditch 23706 was 1.08m wide and 0.24m deep with mottled blue-grey and brown sandy clay fill devoid of finds.
- 4.27.11 Ditch 23712 was located 4m to the east of ditch 23706. It was aligned N-S and was not excavated. It measured 1.5m wide. Ditch 23712 cut ditch 23704 on an E-W alignment, which appeared to turn the south. It measured 0.6m wide and 0.2m deep, and was filled with a blueish-grey sandy clay, devoid of finds (Plate 24).

## 4.28 Trenches 242-248 (Figs 52 and 54)

- 4.28.1 This group of trenches were situated in in the eastern part of Land Parcel 107 and west of the eastern arm of Fen Lane.
- 4.28.2 **Trench 242** was the westernmost of the group and was orientated N-S across the narrow part of the land parcel. The surface of the natural was patchy, and a struck flint was recovered from this.
- 4.28.3 **Trench 243** was situated east of Trench 242 and north of Trench 244. A struck flint was recovered from the topsoil and from the surface of the natural (24302). Cut into the natural were three ditches. Ditch 24307 was located in the central part of the trench and was not excavated. It measured 3.19m wide.
- 4.28.4 At the eastern end of the trench were two parallel adjacent ditches aligned NNW-SSE, ditch 24303 immediately to the east of ditch 24305. Ditch 34303 measured 0.64m wide and 0.18m deep (Plate 25). It contained a single light yellowish grey clay silt (24304), from which six sherds of pottery of middle

Bronze Age to middle Iron Age date and burnt flints were recovered. Ditch 24305 measured 1.29m wide and 0.27m deep (Plate 26). It was filled with a light yellowish blue clayey silt (24306) that contained a struck flint.

- 4.28.5 **Trench 244** was situated to the south of Trench 243. A struck flint was recovered from the surface of the natural (24402). Cut into the natural were three ditches aligned broadly N-S. Ditch 24408 at the east end of the trench was unexcavated.
- 4.28.6 Ditch 24403 was at least 3.58m wide and at least 0.53m deep, but was not bottomed (Plate 27). It contained two fills, the earlier fill (24409) being a light blue clay silt, the upper fill (24405) a dark grey-blue clay silt that contained a struck flint and animal bone. Neither fill was bottomed.
- 4.28.7 The east side of ditch 24403 was cut by ditch 24404, which measured 2.6m wide and at least 0.54m deep, but was again not bottomed. This was on a similar orientation to ditch 24403, but was orientated slight more to the NNE. It also contained two fills, the upper 24406, the lower 24407, both of which comprised dark red-brown silty clay (Plate 27). No finds were present. Unexcavated ditch 24308 to the north was on the projected line of ditch 24404, so may have been a continuation.
- 4.28.8 **Trench 245** was situated in the north-eastern corner of Land Parcel 107, adjacent to Fen Lane. Struck flints were recovered both from the topsoil and subsoil in this trench. Cut into the natural below the subsoil was a ditch on a WNW-ESE alignment. Ditch 24503 measured 1.0.6m wide and 0.42m deep (Plate 28). It had a single greyish-blue silty clay fill with a little charcoal, from which environmental sample <S28> was taken, but was devoid of finds. The sample confirmed that the charcoal was rare and of very small size.
- 4.28.9 **Trench 246** was situated to the south-east of Trench 245. A broad feature, probably a ditch aligned N-S, was revealed at the south-west end. The ditch (24603) measured 1.7m wide and 0.42m deep (Plate 29). It contained a single grey-orange sandy clay, from which early post-medieval (16th century?) brick and roof tile was recovered. No continuation was seen on the projected line of this ditch in Trench 250 to the south, so it must have ended or turned before this.
- 4.28.10 **Trench 247** was situated to the south-west of Trench 246. It revealed three ditches and a layer on a broadly WSW-ENE alignment. The three ditches were intercutting (Plate 30). Ditch 24703 was the southernmost, and ditch 24709 the most northerly, and both were cut by ditch 24705 between them, and so their full widths were not seen. Ditch 24703 truncated layer 24712 (a yellow-brown silty clay spread, 0.24m deep) on its south side. Ditch 24703 was 0.46m deep and was filled with a grey-brown silty clay (27404).
- 4.28.11 Ditch 24705 was also aligned ENE-WSW and was 1.9 m wide, but its full depth was not exposed. The visible part measured 0.54m deep and contained three fills. The earliest (24706) lay on a shelf in the northern edge of the cut and was a yellow-brown silt-clay devoid of finds. This was overlain by a grey/black and blue silty clay (24707) with frequent charcoal fragments. The upper fill (24708) was a mottled yellow-brown silt clay from which animal bone and 20th century glass was recovered.

- 4.28.12 Ditch 24709 on the north survived 1.08m wide with a wide bowl-profile and an estimated total width of around 1.7m. It was 0.36m deep and contained two fills: the earlier fill (24710) was an orangish-brown silty clay, the later fill a lighter version of the same soil. Neither contained finds.
- 4.28.13 **Trench 248** was situated to the east of Trench 247. It revealed one modern ditch (24803) that was not excavated.

## 4.29 Trenches 283-5 (Figs 53 and 54)

- 4.29.1 This group of trenches lay at the east end of Land Parcel 104 south of the A13.
- 4.29.2 **Trench 283** was located to the east of Trench 280 and to the south of Trenches 281 and 282, none of which contained archaeological remains. At the west end of the trench, a ditch (28303) aligned NNW-SSE and a pit or ditch terminal (28305) were recorded.
- 4.29.3 Ditch 28303 measured 1.15m wide and 0.36m deep and contained a single fill (28304) of reddish-brown clay and gravel, from which two sherds of late Iron Age or Roman pottery were recovered.
- 4.29.4 Pit or ditch terminal 28305 lay west of ditch 28303 against the north edge of the trench. It measured 0.71m wide, had vertical sides and was at least 0.63m deep, but was not bottomed for health and safety reasons. It contained a single fill of dark brown-grey clay silt, from which CBM of 17th-18th century date was recovered.
- 4.29.5 **Trench 284** was located to the east of Trenches 282 and 283 and to the south of Trench 285. The trench contained an ENE-WSW aligned ditch (28404) in the northern part of the trench. The central part of the trench contained a pit (28406) and two ditches (28408 and 28410) aligned NW-SE. A sub-circular natural feature (28403) was revealed in the northern part of the trench.
- 4.29.6 Ditch 28404 measured 0.94m wide and 0.21m deep and contained a single fill of dark greyish brown sand-silt fill (28405), from which a little slag was recovered. To the south, ditch 28408 was aligned NW-SE and measured 0.5m wide and 0.4m deep. It contained a single a light orange-grey fine silty fill (28409), which contained a single sherd of medieval pottery.
- 4.29.7 A pit (28406) cut ditch 28408 and measured 0.7m wide and 0.18m deep. It contained a single dark grey-brown silty clay fill, and this produced metallic material including spheroids and hammerscale indicative of smithing.
- 4.29.8 Ditch 28408 was also cut by a larger ditch (24810) on its west side. This was aligned broadly NW-SE, though on a more westerly alignment than 28408, and measured at least 2.84m wide (its full extent was not seen) and at least 0.4m deep, but was not bottomed. Ditch 28410 contained three fills (28411, 28412 and 28413). The earliest fill exposed (28413) was a dark brownish-grey sandy clay, which contained three sherds of medieval pottery and a piece of slag. This was overlain by fill 28412, a yellow-brown mottled clay silt that contained four sherds of medieval pottery and more slag. The latest fill (28411), which occupied the centre of the ditch, was a grey-brown silt-clay containing two sherds of medieval pottery, two roof tile fragments

whose fabric suggested a post-medieval date and slag including tap slag from a furnace.

- 4.29.9 **Trench 285** was located to the north of Trench 284. It contained a single N-S-aligned ditch (28503) measuring 1.15m wide and 0.3m deep and containing a single orange-brown silty clay fill (28504), from which four sherds of medieval pottery and a piece of slag were recovered.

### 4.30 Trenches 297-8, 300 and 303 (Fig. 55)

- 4.30.1 This group of trenches lay at the west end of Land Parcel 31 just north of the A13. Most of the trenches were blank, but several at the south end contained archaeological or natural features.
- 4.30.2 **Trench 297** contained a natural feature (29703) at its north end.
- 4.30.3 **Trench 298** lay on the west close to Mill Lane, and revealed a ditch running WSW-ENE. Ditch 29802 was 1.27m wide and at least 0.52m deep, as it could not be bottomed for health and safety reasons. The ditch was steep-sided, the sides splaying at the top, and the exposed fills (29803 below 29804) were both dark greyish-brown clayey silts without finds.
- 4.30.4 **Trench 300** lay east of Trench 298 beyond blank Trench 299, and revealed a single ditch on a WSW-ENE alignment. Ditch 30003 was 1.26m wide, but was not excavated, as it was on the same line as ditch 29802, and was probably a continuation; both coincide with a post-medieval field boundary marked on the 1897 OS map (OA 2020a, figure 7).
- 4.30.5 **Trench 303** lay south of Trench 300 and just north of the A13, and exposed a double ditch on a NNW-SSE alignment. The soilmark was 2.38m wide, and excavation revealed two parallel cuts, the eastern one 1.78m wide and 0.54m deep, the western one 0.5m wide and 0.44m deep, both having steep sides and a flat base. The lower fill of both cuts (numbered 30306 in the western cut and 30304 in the eastern cut) was a blackish-brown soft clayey silt, and fill 30304 contained CBM of 18th and 19th century date. These fills were sealed by a yellowish-brown clayey silt (30305) that filled both ditches and was clearly deliberate backfill. This ditch also corresponds to a field boundary on the 1897 OS map.

### 4.31 Finds summary

- 4.31.1 **Prehistoric pottery.** A total of 75 sherds of prehistoric pottery (200g) was recovered. Much of the pottery is broadly dated to the middle Bronze Age to Iron Age period and comprises small and abraded sherds, though the early Neolithic and late Bronze Age are also represented within the small assemblage.
- 4.31.2 **Late Iron Age and Roman pottery.** An assemblage of Roman pottery comprising 222 sherds (3147g) was collected. Whilst a large proportion of the pottery could not be more closely dated within the Roman period, there is an emphasis on the middle Roman period and to a lesser extent the late Iron Age/early Roman period.
- 4.31.3 **Medieval and post-medieval pottery.** Post-Roman pottery consisting of 143 sherds (1508g) largely dates to the late medieval period, though a few



sherds of Anglo-Saxon, early post-medieval and 19th-century pottery have also been identified.

- 4.31.4 **Flint.** An assemblage of 77 pieces of worked flint and over 1000 fragments of unworked burnt flint (4351g) was retrieved from the site. A significant element of the flint assemblage was of blades, indicating a definite Mesolithic or early Neolithic component, and the four tools also included a serrated blade likely to be of earlier prehistoric date. Much of the worked flint was residual in later features, and there were no concentrations of flint in particular features that might have been contemporary. A fair proportion of the flints came from a limited number of trenches in land parcel 107, although there were no concentrations. Although the large quantity of burnt material is largely undiagnostic, it is notable for having been recovered mostly from cremation burials.
- 4.31.5 **Fired clay.** A single piece of fired clay was recovered, comprising a late Bronze Age perforated slab or plate.
- 4.31.6 **Ceramic building material (CBM).** A total of 84 fragments of CBM (5.7kg) were retrieved, the majority consisting of post-medieval brick, floor tile and roof tile, though fragments of Roman and medieval/post-medieval tile were also identified.
- 4.31.7 **Metals.** Seventy-one iron objects (589.3g), including nails, rods and chain links, were collected, most of which are of late post-medieval or modern date. A worn and corroded copper alloy coin was also recovered and has been interpreted as a possible late 3rd-century AD radiate.
- 4.31.8 **Glass.** Twenty-one shards of generally 19th- or early 20th-century glass were retrieved. Most comprise wine bottle fragments.
- 4.31.9 **Worked stone.** Nine fragments of worked stone were recovered from four contexts. A fragment of whetstone fabricated from Norwegian Rag was recovered from Trench 89. Norwegian Rag was the stone type most commonly used for whetstones in Britain from the 9th century onwards. Small, degraded fragments of Mayen lava rotary quern were recovered from Trenches 143, 284 and 285. Mayen lava querns can be of Roman or medieval date. The associated pottery suggests a Roman date in Trench 143 and a medieval date in Trenches 284 and 285.
- 4.31.10 **Slag.** Twenty-nine fragments of slag were recovered from deposits in Trenches 284 and 285, both hand-recovered and from samples. The fragments include small amounts of tap slag and hammerscale, suggesting both smelting and smithing in the vicinity. The date of the associated pottery suggests that this probably took place in the medieval period.
- 4.31.11 **Clay tobacco pipe.** Two stem fragments of clay pipe weighing were recovered from two contexts in Trenches 221 and 303.

## 4.32 Environmental summary

- 4.32.1 **Charred plant remains and charcoal.** Thirty bulk samples were collected, over half from deposits associated with cremations in Trench 136, but also from a variety of features across the site. Most of the grain is wheat (*Triticum* sp.); one sample contained glume bases that had spelt-like characteristics (*Triticum spelta*). A little oat (cf. *Avena* sp.) and barley

(*Hordeum vulgare*) were also present. Many legumes of various sizes were recovered. The large flots include examples from Roman (3303, 14206), Anglo-Saxon (7604) and medieval (28407) contexts, providing environmental evidence covering several periods. Material from ditches 3303, 4605 and pit 14205 are all good candidates for further analysis, and twig roundwood in several samples offers opportunities for 14C dating to date others.

- 4.32.2 **Animal bone.** Approximately 153 pieces of animal bone (838g), which includes refitting fragments, were recovered from the site. The majority of the fragments are of unidentified mammal bones, though some taxa were identified, comprising cattle, horse, sheep/goat and mole. A near-complete neonatal calf skeleton was found in a ditch in Trench 112 that also produced a small sherd of Roman pottery, but due to the good preservation of the skeleton, the pottery was probably residual. No evidence of burning, gnawing or butchery was observed.
- 4.32.3 **Human remains.** The human bone comprised one early/middle Bronze Age cremation (13611 from pit 13610) and two undated unurned deposits of cremated bone in the same trench (13612 from pit 13609 and 13614 from pit 13613). The remains were in keeping with adult, or possibly adolescent, remains, although no precise age or sex estimations could be made. This is likely to represent a small cemetery of middle Bronze Age date.
- 4.32.4 **Radiocarbon dating.** A single sample of cremated human bone, comprising a probable femur fragment from context 13611 was submitted for radiocarbon dating by Accelerator Mass Spectrometry. The sample provided a date range of 1690-1510 cal BC at 95% confidence (SUERC-96933; 3328 ± 24 BP).

## 5 Discussion

---

### 5.1 Reliability of field investigation

- 5.1.1 The layout of trenches provided good overall coverage of the site. However, the need to omit several trenches due to uncharted services and limitations on access mean that small areas in four land parcels could not be evaluated.
- 5.1.2 The conditions varied throughout the fieldwork, with periods of dry weather accompanied by frequent rainfall. Conditions were generally drier in the secondary phase of evaluation, although there was rain at times. Fortunately, the conditions did not hamper the investigations and provided a good opportunity for features to 'weather out'. Across Land Parcel 35 and the eastern part of Land Parcel 3 this meant that the features were easily identified against the underlying sand, silts and clay of the Lambeth Group. The Boyn Hill Gravels revealed across much of Land Parcel 30, on the other hand, were dominated by naturally silted depressions which bore a close resemblance to archaeological features and are likely to have been the cause of the many discrete cropmarks. However, a large number of putative archaeological features were excavated across the site to ensure that archaeological remains did not go unrecognised.
- 5.1.3 The correlation between the cropmarks and the archaeological features was varied across the land parcels, but generally favoured the ditched enclosure systems recorded in Land Parcels 3 and 35. In particular, there was a very good correlation between the cropmark features targeted by Trenches 135 to 150 and the archaeological remains they revealed. Inevitably, discrete features were underrepresented but the concentration of activity was particularly well indicated by the cropmarks in this area of the site. This is also the case for the north-east corner of Land Parcel 3 and Land Parcel 35, where most linear cropmarks were matched with underlying ditches.
- 5.1.4 The efficacy of the evaluation in identifying the features that generated the cropmarks is a good indicator for the reliability of this investigation. A notable exception was the ring ditch targeted by Trench 26, where no corresponding archaeological feature was identified despite meticulous hand cleaning. Presumably the feature had been removed by ploughing since it was first recorded. Overall, the identification of multiple features not previously recognised as cropmarks again demonstrates that the evaluation is a reliable indicator for the determining the archaeological potential of this site.

### 5.2 Interpretation

- 5.2.1 **Mesolithic, Neolithic and early Bronze Age.** No features or finds diagnostic of the Mesolithic period were recovered, although a few of the struck flints, including a core, are likely to belong to this period. The earliest feature recorded on the site was pit 8802, which produced several sherds of early Neolithic pottery. A serrated flint blade of the same date was recovered from the ploughsoil of the same trench. Other finds of pottery and

flint have been tentatively dated to the same period from the adjacent Trench 96. Together the evidence suggests a focus of activity at the east end of Land Parcel 30.

- 5.2.2 A broad and shallow ditch in Trench 61 at the west end of Land Parcel 30, which is believed to correspond to a circular cropmark ring ditch, also contained two small sherds of pottery potentially of early Neolithic date, though these may instead have been later prehistoric. At 20m in diameter, the circular cropmark enclosure is rather large for a later prehistoric roundhouse enclosure, and would fit better with an earlier prehistoric monument, though such an enclosure of early Neolithic date would be unusual.
- 5.2.3 Another focus of activity may be present within or close to Land Parcel 107. Small quantities of worked flint from Land Parcel 107 hint at the existence of relatively undisturbed earlier prehistoric flint scatters in the north-western part of the site, where the ground dips into a valley at the edge of the Mar Dyke. Such locations are often favoured for earlier prehistoric activity. The absence of associated features identified by the evaluation here may indicate that this was largely derived from surface scatters, although features of earlier prehistoric date are often small and scattered, so are not easy to locate with limited trenching. The lack of access to two trenches in this area does not help.
- 5.2.4 There were many undated shallow pits and hollows from across the site that could potentially relate to earlier prehistoric activity. Whether the identified remains represent settlement evidence or more transitory activity cannot be established on the basis of the limited remains from the evaluation. The proximity of the Orsett causewayed enclosure c 0.5km east of the site demonstrates that people would have been drawn to the area throughout this period and more remains of this date are likely given the limitations of trial trenching in identifying remains of this period. No features or diagnostic finds of late Neolithic and early Bronze Age activity were found in the evaluation.
- 5.2.5 **Later Bronze Age to Iron Age.** Three unurned cremations without finds were found in Trench 136, and one of these in cremation pit 13610 was radiocarbon dated to 1690-1510 cal BC at 95% confidence (SUERC-96933; 3328 ± 24 BP), at the transition of the early-middle Bronze Age. The other two cremations from this trench, although not radiocarbon dated, are likely to belong to the same period, forming a small cremation cemetery. Flat cemeteries (burials not covered by mounds) are common in the middle Bronze Age, and sometimes occur in association with round barrows or enclosure or field systems, and sometimes in apparent isolation. It is possible that the cremations here were buried alongside ditches 13603 or 13605 that corresponded to a NE-SW linear cropmark, but this was not dated, so the association is unproven. Other than a cemetery found south of a large ring ditch at East Tilbury, this appears to be the only unenclosed middle Bronze Age cemetery in the area, and the East Tilbury example could be considered to be peripheral to the ring ditch.

- 5.2.6 There was no other proven activity of middle Bronze Age date from the site, although a number of the small flint-tempered sherds that were recovered may have been of this date.
- 5.2.7 Later Bronze Age or earlier Iron Age evidence is limited to small quantities of pottery from Land Parcels 3, 30 and 107. Struck flints also come from these same areas, and may also reflect activity of the later Bronze Age, although no pieces diagnostic of this period were found. Generally the pottery comprised small, abraded sherds. The most notable assemblages from this period were those recovered from pit 9302 and ditches 10003 and 17603. The pottery from these features comprised several sherds and were less abraded than those recovered from the rest of the site. Similar features were found adjacent to these and were either undated or contained just small, abraded sherds of middle Bronze Age or Iron Age pottery. At the very least these indicate the presence of a late prehistoric field system, but with the presence of postholes and pits, many of which are undated, it is possible that there are remnants of domestic occupation as well, although these features appeared to have been significantly truncated by subsequent agricultural activity. A perforated clay slab dating to the late Bronze Age was recovered from Trench 184 in Land Parcel 3.
- 5.2.8 A particularly good demonstration of the truncation that has taken place is provided by the annular cropmark targeted by Trenches 61 and 62. Due to the size and form of the cropmark, it is likely that this was generated by the remains of a Bronze Age barrow, but only a broad and very shallow ditch 0.12m deep survived, and this only produced two small sherds of pottery, whose date may either have been early Neolithic or later Bronze Age/Iron Age.
- 5.2.9 **Late Iron Age and Roman period.** The main phase of activity on the site appears to develop at the very beginning of the Roman period with a distinct focus in the southern part of Land Parcel 3. While pottery of late Iron Age tradition was recovered, much of this was found in association with Roman-period material. While late Iron Age activity cannot be ruled out, there is no firm evidence for activity beginning before c AD 43. Trenches 135 to 150 were all targeted on a series of rectilinear cropmarks which previous phases of investigation (OA 2020b) have proven to be predominantly Roman in date.
- 5.2.10 During this phase of fieldwork, the principal enclosure targeted by Trenches 139, 140 and 141 appears to define and enclose the main focus of Roman settlement until the end of the 3rd century. Within the enclosure there is a dense concentration of features that comprise a series of ditched subdivisions as indicated by the cropmarks, alongside distinct settlement evidence indicated by clusters of shallow pits and postholes, particularly in Trenches 143, 145 and 148. The suggestion that this forms the focus of the settlement is further attested by the pottery assemblage, the preservation of which was best in Trenches 139, 140, 142, 143 and 150. The focus of activity was contemporary with the activity previously identified at the Hornsby Lane site (OA 2020b).
- 5.2.11 Whilst the evaluation of Land Parcel 3 south revealed the remains of a Roman cremation burial in the enclosure to the east of Trench 149 (OCA

2020, no further burials were found in the vicinity during this investigation. However, the presence of a cemetery within the rectangular area defined by the cropmarks to the east of Trench 149 cannot be ruled out due to the potential for a scattered distribution of such features.

- 5.2.12 Only one of the three unurned cremation burials that were recorded in Trench 136, to the north of the enclosure, was radiocarbon dated, and this yielded a date at transition of the early-middle Bronze Age. While it is more probable that the two undated cremations were also of similar date, given their proximity to the Roman settlement it is also possible that they were Roman rather than later prehistoric.
- 5.2.13 The ditched enclosures at the southern end of Land Parcel 3 provide a clear focus of activity during this period, but evidence from across the rest of the site indicates a more widespread impact on the landscape. These included ditches in Trenches 186 and 172 on the higher ground at the east of Land Parcel 3, which both contained Roman pottery. The pair of parallel ditches in Trench 172 were both aligned with a pair of linear cropmarks and suggest the presence of a driveway or track, perhaps connecting the settlement at Heath Place to the area around Orsett Cock.
- 5.2.14 A small apparently isolated assemblage of Roman pottery from ditch 3303 accompanied by charred remains of wheat and barley is likely to be at the periphery of a separate Roman focus, extending to the north and defined by the cropmark complex recorded in this area.
- 5.2.15 Further scattered remains of Roman material recovered from Land Parcels 30, 35 and 103 were generally abraded, showed signs of reuse or were residual in later contexts. This indicates a broader spread of Roman activity, but this was clearly distanced from the main settlement foci. The large network of NNW–SSE aligned enclosures that spread along and to the north of the A13 at this location probably has its origins in the Roman period.
- 5.2.16 **Medieval.** A single early to middle Anglo-Saxon pit was recorded near the centre of Land Parcel 30 in Trench 76. Though an isolated feature, it does nonetheless attest to occupation of this date in the vicinity of the site. Evidence for contemporaneous settlement is known at Orsett Cock, and an Anglo-Saxon cemetery has been recorded at Heath Place. The evidence at the current site therefore lies within a wider landscape of Anglo-Saxon activity.
- 5.2.17 Pottery attests to significant occupation in the area during the later medieval period, although material occurred mostly in isolated, scattered contexts. Nearly 1kg of 13th/14th century pottery was recovered from a single pit, 10404, at the south-east corner of Land Parcel 30. The feature itself was almost completely truncated by ploughing and without any obviously contemporary features nearby, the significance of the material and feature is unclear.
- 5.2.18 One focus of medieval activity is suggested by features and finds in two trenches (Trenches 284 and 285) in the south-eastern corner of Land Parcel 104. Ditches, from which medieval pottery, fragments of rotary quern and a small amount of metalworking slag were recovered indicate a focus of activity of probable 11th to 13th-century date associated with possible

enclosures. The top fill of one of the ditches included two fragments of roof tile tentatively dated to the 17th-18th century, but these need not preclude a medieval date for the main activity. In addition, recent excavations on the west side of London have shown that the dating of tile fragments based on fabric is not reliable, and that such tiles may instead be of later medieval date (Cotter 2009; Allen with Evans forthcoming). The iron working found in the features suggests that both smithing and smelting may have been carried out in the vicinity.

- 5.2.19 A small quantity of late medieval pottery was also recovered from ditch 14115 in the south of Land Parcel 3. However, this feature appears to be part of the Roman settlement enclosure, so it is possible that the pottery was intrusive, introduced from one of several later features that intersect the ditch at this location.
- 5.2.20 **Post-medieval.** Activity during this period was limited and mostly represented by sparse distributions of pottery, CBM and metalwork across the site. Much, if not all deposition of such material is likely to have been incidental and the result of agricultural processes.
- 5.2.21 **Undated.** Many of the features across the land parcels were undated. Given the nature of the geology, it is possible that some of these were simply of natural or geological origin. Others may have been so substantially truncated by ploughing that they left only shallow remnants without finds, or they may have lacked artefactual inclusions because they were peripheral to any areas of contemporary activity. It has been suggested already that many of these features may be the remains of scattered late prehistoric settlement and field systems, or in the case of the NNW–SSE aligned field systems they were established during the Roman period, matching the alignment of the enclosures at Hornsby Lane and Heath Place. However, the evidence for scattered activity from the early Neolithic through to the late medieval period prevents a firm conclusion from being drawn.

## 5.3 Evaluation objectives and results

### General Aims

- 5.3.1 **Aims i-iii.** The evaluation established the presence of archaeological remains from the early Neolithic (and probably later Mesolithic) to the late medieval period and identified several areas that were devoid of archaeological features. Overall, the cropmark data has been shown to be reasonably reliable for identifying the areas of archaeological activity, but as is often the case it was not a good indicator for the density of activity or for locating discrete features. In Land Parcels 30 and 107 in particular, numerous linear and discrete features were revealed that had not been indicated as cropmark features.
- 5.3.2 **Aim iv.** The evaluation demonstrated that the greatest complexity of archaeology was located in the southern part of Land Parcel 3, where the Roman settlement was focused. However, even in the densest areas of activity, the remains appeared to have been truncated by ploughing, leaving mostly shallow features and simple stratigraphy. Other than in Land Parcel 107, no deep sediment sequences or buried archaeological horizons were

encountered (as indicated by the largely flat topography), with the exception of Trench 171, which revealed the beginning of a dry valley, although this was almost entirely beyond the site boundary. In Land Parcel 107, where the ground dropped away towards the Mar Dyke valley, the soils were more clayey, and alluvium was found in several trenches on the west side, with a sequence of three alluvial fills in Trench 135. Although no buried archaeological horizons were found, the potential for such deposits clearly exists in Land Parcel 107, and these may well exist in other parts of this land parcel.

- 5.3.3 **Aims v-vi.** The evaluation has established the date of a reasonable proportion of the remains present, has demonstrated the state and preservation of the archaeological artefacts and has provided a good indication about the potential for information about the economy, status and past inhabitants of the site, with evidence of concentrations of particular materials or activities in several parts of the site.
- 5.3.4 **Aim vii.** Paleoenvironmental samples were recovered and have demonstrated that there are deposits with good preservation of charred plant remains. The survival of animal bone is poor, and probably confined to the medieval and post-medieval periods. No waterlogged deposits were encountered, but the potential for such deposits in low-lying Land Parcel 107 is clear, and waterlogged deposits may also be found in the lower fills of some of the deeper features that were not bottomed during evaluation.

#### **Specific Objectives**

- 5.3.5 **Aim xiii.** The evaluation was conducted within the parameters and objectives of the revised East of England Research Framework (Medlycott 2011) and takes account of the aims and objectives of the Greater Thames Estuary Historic Environment Research Framework.
- 5.3.6 **Aim xiv.** The evaluation has demonstrated that, where present, the cropmark data is an accurate indicator for the presence of underlying remains, with the exception of the penannular feature in Land Parcel 35, which could not be related to any underlying feature, suggesting that significant truncation has taken place since the cropmark was recorded.
- 5.3.7 Targeting of the apparently blank areas has shown that not all archaeological features have led to the development of cropmarks in these fields. Particularly across Land Parcels 30 and 107, there were a number of linear features that did not correspond with mapped cropmarks. It has also shown that whilst the cropmarks can provide an indication for an area of activity, in this case it is not a reliable indicator for the density of remains that were present.
- 5.3.8 **Aim xv.** No finds of certainly Mesolithic date were recovered during the fieldwork, although some of the struck flints are most likely of later Mesolithic (or even earlier) date, but a single pit dating to the early Neolithic period was located. This along with other findspots of flint and possible early Neolithic pottery demonstrate that remains of this date are present. However, their limited number prevents any meaningful conclusions to be drawn about their relationship with the causewayed enclosure.



- 5.3.9 The concentration (albeit slight) of struck flint in the trenches in Land Parcel 107 suggests that one focus of later Mesolithic and/or early Neolithic activity may have been the land at the margins of the Mar Dyke valley. The absence of below-ground features does not impede this interpretation, as much activity of these periods consisted of surface spreads that are often reworked into later subsoils and topsoil by ploughing, and below-ground features are often dispersed, and so not easy to identify through evaluation alone.
- 5.3.10 **Aim xvi.** No remains were encountered that could be attributed to the later Neolithic or early Bronze Age.
- 5.3.11 **Aim xvii.** The circular ring ditch indicated by a cropmark within Land Parcel 30, and tested by Trenches 61 and 62, had been heavily truncated by ploughing, and was only tentatively identified in Trench 61 as a very shallow broad feature surviving to a depth of only 0.12m. Its date may be indicated by the recovery of two small sherds of possible early Neolithic pottery, although it is also possible that these sherds are later prehistoric.
- 5.3.12 **Aim xviii.** An unurned cremation radiocarbon dated to the transition of the early-middle Bronze Age was found in Trench 136, and two other undated cremations in the same trench are likely also to be of this date. The burials lay adjacent to a linear ditch, but this was undated, so whether they were associated is unproven. No other features that are certain to be of middle Bronze Age date were identified, although flint-tempered pottery possibly of this date was found, and so the small cemetery appears to be remote from settlement.
- 5.3.13 Features dating to the late Bronze Age and Iron Age were recorded from most of the land parcels that were investigated, with the exception of Land Parcels 103 and 104. However, the scarcity of artefactual evidence means that identifiable prehistoric features were sparsely distributed with no discernible focus of activity. This is perhaps an indication that the sites were short-lived and shifting but given the likelihood that these sites are also somewhat truncated, the picture remains unclear at this stage.
- 5.3.14 **Aim xix.** Whilst later prehistoric features were encountered across the site, the inability to recognise any distinct later prehistoric foci means that it is not possible to determine whether there was a topographic preference. Furthermore, the sites investigated during this stage of fieldwork were predominantly located on relatively flat ground and do not provide enough coverage of low-lying or higher ground to reach an informed conclusion about preferences for one or the other. The features encountered in Land Parcel 107, the only sizeable area of lower-lying ground, were largely undated, although a little later prehistoric pottery and struck flint flakes were found here.
- 5.3.15 **Aim xx.** The extent, character and density of the Roman activity has been established, especially when considered in conjunction with the results of the Hornsby Lane evaluation in the adjacent fields (OA 2020b). The undated cropmark enclosures north of the A13 produced very little dating evidence during the evaluation. However, the larger rectangular enclosure to the east, targeted by Trenches 31, 32, 33 and 34 did produce Roman material in Trench 33 and is likely to be of this date. The parallel ditches in

Trench 7 contained post-medieval finds and clearly indicate a different phase of field systems.

- 5.3.16 Overall, it would appear that a pattern of NNW–SSE aligned field systems was established by the Roman period and became fossilised in the landscape, with subsequent additions following the same broad alignments.
- 5.3.17 **Aim xxi.** No pottery kilns were revealed during this phase of investigations. However, Roman pottery recovered from the site was consistent with material produced at Orsett Cock and Hornsby Lane, pointing to local production. No evidence for Roman roads was discovered.
- 5.3.18 **Aim xxii.** As has been established elsewhere on the LTC scheme in Essex, many of the pit-like cropmarks revealed on the gravel geology are caused by shallow silt pockets in the surface of the gravels. However, they can also provide accurate evidence for features, and the pit-like cropmarks targeted with the open area Trench 148 did correlate with small pits of Roman date. The cropmarks across Land Parcel 30, on the other hand, appeared to have been caused by a combination of undated pits and geological features.
- 5.3.19 **Aim xxiii.** The discovery of a single Anglo-Saxon feature, more than 1km from contemporary evidence at the causewayed enclosure and Orsett Cock, provides little additional information, although it does confirm that this activity did not extend in any significant concentration to the west of these known sites.
- 5.3.20 **Aim xxiv.** Although there is some evidence that the enclosure systems began in the Roman period and continued to develop through the medieval and post-medieval periods, there is limited evidence to date the associated roads and droveways, except to note that these tend to follow the same alignments of the field systems and are likely to be broadly contemporary.
- 5.3.21 **Aim xxv.** The evidence for medieval activity on the site did not include any structural evidence of any medieval or post-medieval farmsteads, but the quantities of medieval pottery and other materials in pit 10404 at the south-east corner of Land Parcel 30 certainly suggest domestic activity very close by. Neither Land Parcel 32 nor the adjacent part of Land Parcel 3 (north) immediately to the east were accessible for evaluation, but in the absence for further evidence of medieval activity in the trenches in Land Parcel 3 to the south, it is likely that the focus of medieval occupation will be found to the east.
- 5.3.22 Although only a modest assemblage of small medieval sherds was recovered from Trenches 284 and 285 towards the east end of Land Parcel 104, they were accompanied by metalworking slag and rotary quern fragments, attesting to some focus of medieval activity in the vicinity. This need not, however, indicate a permanent settlement, and instead could perhaps indicate the activities of a peripatetic smith.

## Appendix A Trench Tables

| Trench 1   |       |         |           |           |  |       |       |
|--|-------|---------|-----------|-----------|--|-------|-------|
| General description  |       |         |           |           | Orientation  |       | E-W   |
| Trench revealed two ditches and three postholes. Trench consists of ploughsoil and subsoil overlying a sandy gravel natural. |       |         |           |           | Length (m)   |       | 30    |
|  |       |         |           |           | Width (m)  |       | 2     |
|  |       |         |           |           | Avg. depth (m)   |       | 0.35  |
| Context No.  | Type  | Fill Of | Width (m) | Depth (m) | Description  | Finds | Date  |
| 100  | Layer |         |           | 0.24      | Ploughsoil. Loose brownish grey, sandy silt.                             |       |       |
| 101  | Layer |         |           | 0.03      | Subsoil. Loose light yellowish brown, sandy silt.                        |       |       |
| 102  | Layer |         |           |           | Natural. Soft light orangish and yellowish brown, silty sand and gravel. |       |       |
| 103  | Cut   |         | 0.32      | 0.23      | Posthole   |       |       |
| 104  | Fill  | 103     | 0.32      | 0.23      | Primary Fill. Loose mid reddish brown silt sand                          | Pot   | PMed  |
| 105  | Cut   |         | 0.32      | 0.09      | Posthole   |       |       |
| 106  | Fill  | 105     | 0.32      | 0.09      | Primary Fill. Loose reddish brown silt sand                              |       |       |
| 107  | Cut   |         | 0.3       | 0.1       | Posthole   |       |       |
| 108  | Fill  | 107     | 0.3       | 0.1       | Primary Fill. Loose reddish brown silt sand                              |       |       |
| 109  | Cut   |         | 0.41      | 0.09      | Ditch  |       |       |
| 110  | Fill  | 109     | 0.41      | 0.09      | Primary Fill. Loose reddish brown sandy silt.                            |       |       |
| 111  | Cut   |         | 1.28      | 0.25      | Ditch  |       |       |
| 112  | Fill  | 111     | 1.28      | 0.36      | Secondary Fill. Loose reddish brown sandy silt.                          | CBM   | Roman |
| 113  | Fill  | 111     | 0.92      | 0.1       | Primary Fill. Friable greyish brown gravelly sand.                       |       |       |
| 114  | Cut   |         | 0.93      | 0.15      | Ditch  |       |       |
| 115  | Fill  | 114     | 0.93      | 0.15      | Primary Fill. Loose, reddish brown, sandy silt.                          |       |       |
| Trench 5   |       |         |           |           |  |       |       |
| General description  |       |         |           |           | Orientation  |       | NW-SE |
| Trench revealed two ditches. Trench consists of ploughsoil and subsoil overlying a sandy gravel natural.                     |       |         |           |           | Length (m)   |       | 30    |
|  |       |         |           |           | Width (m)  |       | 2     |
|  |       |         |           |           | Avg. depth (m)   |       | 0.45  |

| Context No. | Type                | Fill Of | Width (m) | Depth (m) | Description   | Finds            | Date   |
|-------------|---------------------|---------|-----------|-----------|---|------------------|--------|
| 500         | Layer               |         |           | 0.3       | Ploughsoil. Loose mid brownish grey, sandy silt.  |                  |        |
| 501         | Layer               |         |           | 0.15      | Subsoil. Loose light yellowish brown, sandy silt.   |                  |        |
| 502         | Layer               |         |           |           | Natural. Soft light orangish and yellowish brown, silty sand and gravel.  |                  |        |
| 503         | Cut                 |         | 1.1       | 0.16      | Ditch   |                  |        |
| 504         | Fill                | 503     | 1.1       | 0.16      | Deliberate Backfill. Moderately friable greyish brown silty sand with occasional charcoal and CBM flecks. Contained CBM and bone. | CBM, animal bone | C17-18 |
| 505         | Unexcavated feature |         |           |           | Ditch. mid brown sandy silt   |                  |        |

### Trench 6

|   |                |       |
|---|----------------|-------|
| General description   | Orientation    | NE-SW |
| Trench revealed one ditch and a possible pit. Trench consists of ploughsoil and subsoil overlying a sandy gravel natural. | Length (m)     | 30    |
|   | Width (m)      | 2     |
|   | Avg. depth (m) | 0.55  |

| Context No. | Type  | Fill Of | Width (m) | Depth (m) | Description   | Finds | Date |
|-------------|-------|---------|-----------|-----------|---|-------|------|
| 600         | Layer |         |           | 0.25      | Ploughsoil. Loose brownish grey, sandy silt.            |       |      |
| 601         | Layer |         |           | 0.3       | Subsoil. Loose light yellowish brown, sandy silt.       |       |      |
| 602         | Layer |         |           |           | Natural. Soft light reddish brown sandy gravels         |       |      |
| 603         | Void  |         |           |           |   |       |      |
| 604         | Cut   |         | 1.64      | 0.48      | Ditch   |       |      |
| 605         | Fill  | 604     | 1.64      | 0.48      | Deliberate Backfill. Compact greyish brown silty clay   |       |      |
| 606         | Void  |         |           |           |   |       |      |
| 607         | Cut   |         | 0.92      | 0.21      | Pit   |       |      |
| 608         | Fill  | 607     | 0.92      | 0.21      | Secondary Fill. Compact light brownish grey silty clay. |       |      |
| 609         | Fill  | 607     | 0.6       | 0.1       | Primary Fill. Compact brownish red silty clay           |       |      |

| <b>Trench 7</b>  |       |         |           |           |   |          |        |
|--|-------|---------|-----------|-----------|---|----------|--------|
| General description  |       |         |           |           | Orientation                                       |          | E-W    |
| Trench revealed three postholes and two ditches. Trench consists of ploughsoil and subsoil overlying a sandy gravel natural. |       |         |           |           | Length (m)  |          | 30     |
|  |       |         |           |           | Width (m)   |          | 2      |
|  |       |         |           |           | Avg. depth (m)                                    |          | 0.45   |
| Context No.  | Type  | Fill Of | Width (m) | Depth (m) | Description                                       | Finds    | Date   |
| 700  | Layer |         |           | 0.25      | Ploughsoil. brown-grey sandy silt                 |          |        |
| 701  | Layer |         |           | 0.18      | Subsoil. Light yellowish brown gravelly sand      |          |        |
| 702  | Layer |         |           |           | Natural. Light reddish brown silt sand            |          |        |
| 703  | Cut   |         | 0.42      | 0.1       | Posthole  |          |        |
| 704  | Fill  | 703     | 0.42      | 0.1       | Primary Fill. Reddish grey sandy silt             |          |        |
| 705  | Cut   |         | 0.51      | 0.06      | Posthole  |          |        |
| 706  | Fill  | 705     | 0.51      | 0.06      | Primary Fill. Loose reddish grey sandy silt       | Pot      | Roman  |
| 707  | Cut   |         | 0.31      | 0.1       | Posthole  |          |        |
| 708  | Fill  | 707     | 0.31      | 0.1       | Primary Fill. Loose reddish grey sandy silt       |          |        |
| 709  | Cut   |         | 0.66      | 0.16      | Ditch   |          |        |
| 710  | Fill  | 709     | 0.66      | 0.08      | Secondary Fill. Loose reddish grey sandy silt     | CBM      | PMed   |
| 711  | Cut   |         | 0.81      | 0.32      | Ditch   |          |        |
| 712  | Fill  | 711     | 0.81      | 0.07      | Secondary Fill. Loose reddish grey sandy silt     | Pot, CBM | EPMed  |
| 713  | Fill  | 711     | 0.75      | 0.26      | Primary Fill. Friable greyish brown silty sand.   | CBM      | C16-17 |
| 714  | Fill  | 709     | 0.47      | 0.07      | Primary Fill. Friable reddish brown silty sand    |          |        |
| <b>Trench 8</b>  |       |         |           |           |   |          |        |
| General description  |       |         |           |           | Orientation                                       |          | NE-SW  |
| Trench revealed one ditch. Trench consists of ploughsoil and subsoil overlying a sandy gravel natural.                       |       |         |           |           | Length (m)  |          | 27     |
|  |       |         |           |           | Width (m)   |          | 2      |
|  |       |         |           |           | Avg. depth (m)                                    |          | 0.33   |
| Context No.  | Type  | Fill Of | Width (m) | Depth (m) | Description                                       | Finds    | Date   |
| 800  | Layer |         |           | 0.33      | Ploughsoil. Loose brownish grey sandy silt.       |          |        |
| 801  | Layer |         |           | 0.14      | Subsoil. Loose light yellowish brown, sandy silt. |          |        |

|     |       |     |      |      |  |  |  |
|-----|-------|-----|------|------|--|--|--|
| 802 | Layer |     |      |      | Natural. Soft light reddish brown sandy gravels. |  |  |
| 803 | Cut   |     | 1.28 | 0.38 | Ditch  |  |  |
| 804 | Fill  | 803 | 1.3  | 0.3  | Primary Fill. Soft greyish brown silty sand.     |  |  |

### Trench 9

|  |  |  |  |  |                |  |     |
|--|--|--|--|--|----------------|--|-----|
| General description  |  |  |  |  | Orientation    |  | E-W |
| Trench revealed 3 ditches. Trench consists of ploughsoil and subsoil overlying a sandy gravel natural. |  |  |  |  | Length (m)     |  | 30  |
|  |  |  |  |  | Width (m)      |  | 2   |
|  |  |  |  |  | Avg. depth (m) |  | 0.4 |

| Context No. | Type  | Fill Of | Width (m) | Depth (m) | Description                                       | Finds | Date |
|-------------|-------|---------|-----------|-----------|---|-------|------|
| 900         | Layer |         |           | 0.3       | Ploughsoil. Loose brownish grey, sandy silt       |       |      |
| 901         | Layer |         |           | 0.15      | Subsoil. Loose light yellowish brown, sandy silt. |       |      |
| 902         | Layer |         |           |           | Natural. Soft light reddish brown sandy gravels.  |       |      |
| 903         | Cut   |         | 1.28      | 0.44      | Ditch   |       |      |
| 904         | Fill  | 903     | 1.28      | 0.44      | Primary Fill. Loose brownish grey silty sand.     |       |      |
| 905         | Cut   |         | 1.34      | 0.3       | Ditch   |       |      |
| 906         | Fill  | 905     | 1.34      | 0.3       | Primary Fill. loose greyish brown sandy silt.     |       |      |

### Trench 10

|  |  |  |  |  |                |  |       |
|--|--|--|--|--|----------------|--|-------|
| General description  |  |  |  |  | Orientation    |  | NE-SW |
| Trench revealed two ditches. Trench consists of ploughsoil and subsoil overlying a sandy gravel natural. |  |  |  |  | Length (m)     |  | 30    |
|  |  |  |  |  | Width (m)      |  | 2     |
|  |  |  |  |  | Avg. depth (m) |  | 0.5   |

| Context No. | Type                | Fill Of | Width (m) | Depth (m) | Description                                   | Finds | Date |
|-------------|---------------------|---------|-----------|-----------|---|-------|------|
| 1000        | Layer               |         | 2         | 0.3       | Ploughsoil. loose brownish grey sandy silt.   |       |      |
| 1001        | Layer               |         | 2         | 0.15      | Subsoil. yellowish brown sandy silt.          |       |      |
| 1002        | Layer               |         | 2         |           | Natural. light yellowish brown clayey sand.   |       |      |
| 1003        | Cut                 |         | 0.74      | 0.14      | Ditch   |       |      |
| 1004        | Fill                |         | 0.74      | 0.14      | Primary Fill. Loose greyish brown silty sand. |       |      |
| 1005        | Unexcavated feature |         | 1.78      |           | Ditch. Grey-brown sandy silt.                 |       |      |

|      |      |      |      |      |  |  |  |
|------|------|------|------|------|--|--|--|
| 1006 | Fill | 1003 | 1.78 |      | Primary Fill. Unexcavated. Friable greyish brown, silty sand |  |  |
| 1007 | Cut  |      | 0.7  | 0.32 | Ditch. Section in bulk                                       |  |  |
| 1008 | Fill | 1007 | 0.7  | 0.32 | Primary Fill. Friable reddish grey silty sand                |  |  |
| 1009 | Void |      |      |      |  |  |  |

### Trench 11

| General description   |       |         |           |           | Orientation  |       | N-S  |
|---|-------|---------|-----------|-----------|--|-------|------|
| Trench revealed one ditch and one possible pit. Trench consists of ploughsoil and subsoil overlying a sandy gravel natural. |       |         |           |           | Length (m)   |       | 30   |
|   |       |         |           |           | Width (m)  |       | 2    |
|   |       |         |           |           | Avg. depth (m)                                       |       | 0.55 |
| Context No.   | Type  | Fill Of | Width (m) | Depth (m) | Description  | Finds | Date |
| 1100  | Layer |         | 2         | 0.28      | Ploughsoil. loose greyish brown sandy silt.          |       |      |
| 1101  | Layer |         |           | 0.27      | Subsoil. light reddish grey sandy silt.              |       |      |
| 1102  | Layer |         |           |           | Natural. Light reddish brown sandy gravels.          |       |      |
| 1103  | Cut   |         | 0.78      | 0.22      | Ditch  |       |      |
| 1104  | Fill  | 1103    | 0.78      | 0.22      | Primary Fill. loose greyish brown, sandy silt.       |       |      |
| 1105  | Cut   |         | 0.58      | 0.1       | Ditch. Possible ditch terminus or pit                |       |      |
| 1106  | Fill  | 1105    | 0.58      | 0.1       | Primary Fill. Loose light greyish brown, sandy silt. |       |      |

### Trench 12

| General description   |       |         |           |           | Orientation   |       | NW-SE |
|---|-------|---------|-----------|-----------|---|-------|-------|
| Trench devoid of archaeology and consists of ploughsoil and subsoil overlying a sandy gravel natural. |       |         |           |           | Length (m)  |       | 30    |
|   |       |         |           |           | Width (m)   |       | 2     |
|   |       |         |           |           | Avg. depth (m)  |       | 0.65  |
| Context No.   | Type  | Fill Of | Width (m) | Depth (m) | Description   | Finds | Date  |
| 1200  | Layer |         |           | 0.34      | Ploughsoil. Loose brownish grey, sandy silt.                      |       |       |
| 1201  | Layer |         |           | 0.34      | Subsoil. Loose yellowish and greyish brown sandy silt and gravel. |       |       |

| 1202   | Layer |         |           |           | Natural. soft light reddish brown sandy gravels.                        |       |       |
|--|-------|---------|-----------|-----------|---|-------|-------|
| <b>Trench 13</b>   |       |         |           |           |   |       |       |
| General description  |       |         |           |           | Orientation   |       | NE-SW |
| Trench revealed three ditches. Trench consists of ploughsoil and subsoil overlying a sandy gravel natural. |       |         |           |           | Length (m)  |       | 30    |
|  |       |         |           |           | Width (m)   |       | 2     |
|  |       |         |           |           | Avg. depth (m)  |       |       |
| Context No.  | Type  | Fill Of | Width (m) | Depth (m) | Description   | Finds | Date  |
| 1300   | Layer |         |           | 0.31      | Ploughsoil. Loose brownish grey sandy silt.                             |       |       |
| 1301   | Layer |         |           | 0.14      | Subsoil. Soft light yellowish brown sandy silt.                         |       |       |
| 1302   | Layer |         |           |           | Natural. Loose light yellowish brown sandy gravel                       |       |       |
| 1303   | Cut   |         | 0.88      | 0.22      | Ditch   |       |       |
| 1304   | Fill  | 1303    | 0.88      | 0.22      | Primary Fill. Loose greyish brown gravelly sand                         |       |       |
| 1305   | Cut   |         | 0.8       | 0.14      | Ditch   |       |       |
| 1306   | Fill  | 1305    | 0.8       | 0.14      | Primary Fill. Loose greyish brown silty sand                            |       |       |
| 1307   | Cut   |         | 1         | 0.22      | Ditch   |       |       |
| 1308   | Fill  |         | 1         | 0.08      | Secondary Fill. Greyish brown gravelly sand.                            |       |       |
| 1309   | Fill  | 1307    | 0.85      | 0.04      | Primary Fill. Friable mottled reddish grey silty sand.                  |       |       |
| <b>Trench 14</b>   |       |         |           |           |   |       |       |
| General description  |       |         |           |           | Orientation   |       | E-W   |
| Trench revealed one ditch. Trench consists of ploughsoil and subsoil overlying a sandy gravel natural.     |       |         |           |           | Length (m)  |       | 30    |
|  |       |         |           |           | Width (m)   |       | 2     |
|  |       |         |           |           | Avg. depth (m)  |       | 0.5   |
| Context No.  | Type  | Fill Of | Width (m) | Depth (m) | Description   | Finds | Date  |
| 1400   | Layer |         |           | 0.29      | Ploughsoil. Loose brownish grey sandy silt                              |       |       |
| 1401   | Layer |         | 2.1       | 0.28      | Subsoil. Yellowish brown silty sand with occasional sub-angular stones. |       |       |
| 1402   | Layer |         | 2         |           | Natural. Soft yellowish brown sandy gravels                             |       |       |
| 1403   | Cut   |         | 0.85      | 0.3       | Ditch   |       |       |



| 1404   | Fill  | 1403    | 0.85      | 0.3       | Primary Fill. Soft greyish brown silty sand       |       |       |
|--|-------|---------|-----------|-----------|---|-------|-------|
| <b>Trench 15</b>   |       |         |           |           |   |       |       |
| General description  |       |         |           |           | Orientation                                       |       | E-W   |
| Trench revealed three ditches. Trench consists of ploughsoil and subsoil overlying a sandy gravel natural. |       |         |           |           | Length (m)  |       | 30    |
|  |       |         |           |           | Width (m)   |       | 2     |
|  |       |         |           |           | Avg. depth (m)                                    |       | 0.5   |
| Context No.  | Type  | Fill Of | Width (m) | Depth (m) | Description                                       | Finds | Date  |
| 1500   | Layer |         | 2         | 0.3       | Ploughsoil. Loose brownish grey sandy silt.       |       |       |
| 1501   | Layer |         | 2         | 0.2       | Subsoil. Light yellowish brown sandy silt.        |       |       |
| 1502   | Layer |         | 2         |           | Natural. Light yellowish brown sandy gravel.      |       |       |
| 1503   | Cut   |         | 0.8       | 0.18      | Ditch   |       |       |
| 1504   | Fill  | 1503    | 0.8       | 0.18      | Primary Fill. dark grey-brown sandy silt          |       |       |
| 1505   | Cut   |         | 0.54      | 0.17      | Ditch   |       |       |
| 1506   | Fill  | 1505    | 0.54      | 0.17      | Primary Fill. dark grey-brown silty sand          |       |       |
| 1507   | Cut   |         | 0.98      | 0.24      | Ditch   |       |       |
| 1508   | Fill  | 1507    | 0.98      | 0.24      | Primary Fill. Grey-brown silty sand               |       |       |
| <b>Trench 16</b>   |       |         |           |           |   |       |       |
| General description  |       |         |           |           | Orientation                                       |       | E-W   |
| Trench devoid of archaeology. Trench consists of ploughsoil and subsoil overlying a sandy gravel natural.  |       |         |           |           | Length (m)  |       | 30    |
|  |       |         |           |           | Width (m)   |       | 2     |
|  |       |         |           |           | Avg. depth (m)                                    |       | 0.4   |
| Context No.  | Type  | Fill Of | Width (m) | Depth (m) | Description                                       | Finds | Date  |
| 1600   | Layer |         |           | 0.2       | Ploughsoil. Loose brownish grey, sandy silt.      |       |       |
| 1601   | Layer |         |           | 0.2       | Subsoil. Loose light yellowish brown, sandy silt. |       |       |
| 1602   | Layer |         |           |           | Natural. Soft light reddish brown sandy gravels.  |       |       |
| <b>Trench 17</b>   |       |         |           |           |   |       |       |
| General description  |       |         |           |           | Orientation                                       |       | NW-SE |
|  |       |         |           |           | Length (m)  |       | 30    |
|  |       |         |           |           | Width (m)   |       | 2     |

| Trench revealed one ditch and one posthole. Trench consists of ploughsoil and subsoil overlying a sandy gravel natural. Contains one ditch and one porthole. |       |         |           |           |  | Avg. depth (m) | 0.5        |
|--|-------|---------|-----------|-----------|--|----------------|------------|
| Context No.  | Type  | Fill Of | Width (m) | Depth (m) | Description  | Finds          | Date       |
| 1700   | Layer |         |           | 0.31      | Ploughsoil. Loose brownish grey, sandy silt.   |                |            |
| 1701   | Layer |         |           | 0.3       | Subsoil. Loose light greyish brown, sandy silt.  |                |            |
| 1702   | Void  |         |           |           |  |                |            |
| 1703   | Layer |         |           |           | Natural. Soft light yellowish and orangish brown silty sand, with dense patches of gravel. |                |            |
| 1704   | Cut   |         | 1.38      | 0.48      | Ditch  |                |            |
| 1705   | Fill  | 1704    | 1.38      | 0.48      | Primary Fill. Loose, orange-brown, sandy silt.   | Pot            | LBA (res?) |
| 1706   | Cut   |         | 0.42      | 0.5       | Posthole   |                |            |
| 1707   | Fill  | 1706    | 0.42      | 0.5       | Primary Fill. Loose dark greyish brown, sandy silt.  | Pot            | MBA-IA     |

#### Trench 20

|   |  |  |                |  |       |
|---|--|--|----------------|--|-------|
| General description   |  |  | Orientation    |  | NW-SE |
| Trench devoid of archaeology. Trench consists of ploughsoil and subsoil overlying a sandy gravel natural. |  |  | Length (m)     |  | 30    |
|   |  |  | Width (m)      |  | 2     |
|   |  |  | Avg. depth (m) |  | 0.5   |

| Context No. | Type  | Fill Of | Width (m) | Depth (m) | Description  | Finds | Date |
|-------------|-------|---------|-----------|-----------|--|-------|------|
| 2000        | Layer |         |           | 0.25      | Ploughsoil. Loose brownish grey, sandy silt.           |       |      |
| 2001        | Layer |         |           | 0.25      | Subsoil. Loose light pale yellowish brown, sandy silt. |       |      |
| 2002        | Layer |         |           |           | Natural. Loose light grey silty sand and gravel.       |       |      |

#### Trench 21

|   |  |  |                |  |       |
|---|--|--|----------------|--|-------|
| General description   |  |  | Orientation    |  | NE-SW |
| Trench devoid of archaeology. Trench consists of ploughsoil and subsoil overlying a sandy gravel natural. |  |  | Length (m)     |  | 30    |
|   |  |  | Width (m)      |  | 2     |
|   |  |  | Avg. depth (m) |  | 0.4   |

| Context No. | Type  | Fill Of | Width (m) | Depth (m) | Description                                     | Finds | Date |
|-------------|-------|---------|-----------|-----------|---|-------|------|
| 2100        | Layer |         |           | 0.2       | Ploughsoil. Loose mid brownish grey sandy silt. |       |      |

|      |       |  |  |     |   |  |  |
|------|-------|--|--|-----|---|--|--|
| 2101 | Layer |  |  | 0.2 | Subsoil. Loose light pale greyish brown, sandy silt.  |  |  |
| 2102 | Layer |  |  |     | Natural. Loose light pale grey silty sand and gravel. |  |  |

### Trench 22

|   |  |  |  |  |                |  |      |
|---|--|--|--|--|----------------|--|------|
| General description   |  |  |  |  | Orientation    |  | E-W  |
| Trench revealed one ditch and one posthole. Trench consists of ploughsoil and subsoil overlying a sandy gravel natural. |  |  |  |  | Length (m)     |  | 30   |
|   |  |  |  |  | Width (m)      |  | 2    |
|   |  |  |  |  | Avg. depth (m) |  | 0.45 |

| Context No. | Type  | Fill Of | Width (m) | Depth (m) | Description  | Finds | Date |
|-------------|-------|---------|-----------|-----------|--|-------|------|
| 2200        | Layer |         |           | 0.35      | Ploughsoil. Loose mid brownish grey sandy silt             |       |      |
| 2201        | Layer |         |           | 0.15      | Subsoil. Yellowish grey silty sand with patches of gravel. |       |      |
| 2202        | Layer |         |           |           | Natural. Yellowish brown sandy gravel                      |       |      |
| 2203        | Cut   |         | 0.3       | 0.08      | Posthole   |       |      |
| 2204        | Fill  | 2203    | 0.3       | 0.08      | Primary Fill. Brownish grey silty sand                     |       |      |
| 2205        | Cut   | 2205    |           |           | Natural Feature. Rooting, animal burrow.                   |       |      |
| 2206        | Cut   |         | 1.18      | 0.24      | Ditch  |       |      |
| 2207        | Fill  | 2206    | 1.18      | 0.24      | Primary Fill. Reddish brown silty sand                     |       |      |

### Trench 23

|   |  |  |  |  |                |  |       |
|---|--|--|--|--|----------------|--|-------|
| General description   |  |  |  |  | Orientation    |  | NE-SW |
| Trench devoid of archaeology. Trench consists of ploughsoil and subsoil overlying a sandy gravel natural. |  |  |  |  | Length (m)     |  | 30    |
|   |  |  |  |  | Width (m)      |  | 2     |
|   |  |  |  |  | Avg. depth (m) |  | 0.6   |

| Context No. | Type  | Fill Of | Width (m) | Depth (m) | Description                                 | Finds | Date |
|-------------|-------|---------|-----------|-----------|---|-------|------|
| 2300        | Layer |         |           | 0.4       | Ploughsoil. Loose greyish brown sandy silt. |       |      |
| 2301        | Layer |         |           | 0.14      | Subsoil. Greyish brown sandy silt           |       |      |
| 2302        | Layer |         | 2         |           | Natural. Reddish grey sandy gravels.        |       |      |
| 2303        | Cut   | 2303    |           |           | Natural Feature. Geological disturbance     |       |      |

### Trench 24

|                     |  |  |  |  |             |  |       |
|---------------------|--|--|--|--|-------------|--|-------|
| General description |  |  |  |  | Orientation |  | NW-SE |
|---------------------|--|--|--|--|-------------|--|-------|

| Trench revealed one ditch. Trench consists of ploughsoil and subsoil overlying a sandy gravel natural. |       |         |           |           | Length (m)   | 30    |      |
|--|-------|---------|-----------|-----------|--|-------|------|
|  |       |         |           |           | Width (m)  | 2     |      |
|  |       |         |           |           | Avg. depth (m)   | 0.45  |      |
| Context No.  | Type  | Fill Of | Width (m) | Depth (m) | Description  | Finds | Date |
| 2400   | Layer |         |           | 0.25      | Ploughsoil. Loose brownish grey, sandy silt.                 |       |      |
| 2401   | Layer |         |           | 0.2       | Subsoil. Loose light orange-brown, sandy silt.               |       |      |
| 2402   | Layer |         |           |           | Natural. Loose light orange-brown and white sand and gravel. |       |      |
| 2403   | Cut   |         | 0.94      | 0.14      | Ditch  |       |      |
| 2404   | Fill  | 2403    | 0.94      | 0.14      | Primary Fill. Friable greyish brown silty sand               |       |      |

### Trench 25

|  |  |  |  |  |                |                |
|--|--|--|--|--|----------------|----------------|
| General description  |  |  |  |  | Orientation    | NE-SW to NW-SE |
| Trench revealed two ditches. Trench consists of ploughsoil and subsoil overlying a sandy gravel natural. |  |  |  |  | Length (m)     | 40             |
|  |  |  |  |  | Width (m)      | 2.2            |
|  |  |  |  |  | Avg. depth (m) | 0.55           |

| Context No. | Type  | Fill Of | Width (m) | Depth (m) | Description   | Finds | Date   |
|-------------|-------|---------|-----------|-----------|---|-------|--------|
| 2500        | Layer |         |           | 0.3       | Ploughsoil. Loose brownish grey sandy silt.               |       |        |
| 2501        | Layer |         |           | 0.35      | Subsoil. Loose light yellowish brown, sandy silt.         |       |        |
| 2502        | Layer |         |           |           | Natural. light grey-brown sandy gravels.                  |       |        |
| 2503        | Cut   |         | 1         | 0.26      | Ditch   |       |        |
| 2504        | Fill  | 2503    | 1         | 0.26      | Primary Fill. Greyish brown silty sand                    |       |        |
| 2505        | Cut   |         | 0.96      | 0.3       | Ditch   |       |        |
| 2506        | Fill  | 2505    | 0.96      | 0.3       | Primary Fill. Dark greyish brown silty sand               |       |        |
| 2507        | Cut   |         | 1.22      | 0.44      | Ditch. Modern. Not fully excavated as went over 1m depth. |       |        |
| 2508        | Fill  | 2507    | 1.22      | 0.44      | Primary Fill. Greyish brown silty sand                    | CBM   | C18-19 |
| 2509        | Cut   | 2509    |           |           | Natural Feature. Animal burrow                            |       |        |

| Trench 26   |       |         |           |           |  |       |       |
|---|-------|---------|-----------|-----------|--|-------|-------|
| General description   |       |         |           |           | Orientation  |       | NE-SW |
| Trench devoid of archaeology. Trench consists of ploughsoil and subsoil overlying a sandy gravel natural. |       |         |           |           | Length (m)   |       | 30    |
|   |       |         |           |           | Width (m)  |       | 2.2   |
|   |       |         |           |           | Avg. depth (m)   |       | 0.45  |
| Context No.   | Type  | Fill Of | Width (m) | Depth (m) | Description  | Finds | Date  |
| 2600  | Layer |         |           | 0.3       | Ploughsoil. Loose brownish grey, sandy silt.   |       |       |
| 2601  | Layer |         |           | 0.13      | Subsoil. Loose light yellowish brown, sandy silt.  |       |       |
| 2602  | Layer |         |           |           | Natural. Soft light reddish brown sandy gravels.   |       |       |
| 2603  | Cut   |         |           |           | Natural Feature. Natural sand and rooting. Thought to be possible ring ditch however it was not. |       |       |
| Trench 27   |       |         |           |           |  |       |       |
| General description   |       |         |           |           | Orientation  |       | NW-SE |
| Trench revealed one ditch. Trench consists of ploughsoil and subsoil overlying a sandy gravel natural.    |       |         |           |           | Length (m)   |       | 30    |
|   |       |         |           |           | Width (m)  |       | 2.2   |
|   |       |         |           |           | Avg. depth (m)   |       | 0.55  |
| Context No.   | Type  | Fill Of | Width (m) | Depth (m) | Description  | Finds | Date  |
| 2700  | Layer |         |           | 0.25      | Ploughsoil. Loose mid brownish grey sandy silt.  |       |       |
| 2701  | Layer |         |           | 0.3       | Subsoil. Loose light yellowish brown, sandy silt.  |       |       |
| 2702  | Layer |         |           |           | Natural. Loose light grey-brown sandy gravels.   |       |       |
| 2703  | Cut   |         | 1.24      | 0.28      | Ditch  |       |       |
| 2704  | Fill  | 2703    | 1.24      | 0.28      | Primary Fill. Greyish brown silty sand   |       |       |
| Trench 28   |       |         |           |           |  |       |       |
| General description   |       |         |           |           | Orientation  |       | NE-SW |
| Trench devoid of archaeology. Trench consists of ploughsoil and subsoil overlying a sandy gravel natural. |       |         |           |           | Length (m)   |       | 30    |
|   |       |         |           |           | Width (m)  |       | 2.2   |
|   |       |         |           |           | Avg. depth (m)   |       | 0.43  |
| Context No.   | Type  | Fill Of | Width (m) | Depth (m) | Description  | Finds | Date  |
| 2800  | Layer |         | 2         | 0.28      | Ploughsoil. Loose greyish brown sandy silt   |       |       |

|      |       |  |   |      |   |  |  |
|------|-------|--|---|------|---|--|--|
| 2801 | Layer |  | 2 | 0.15 | Subsoil. Firm yellowish brown with gravel inclusions, silty sand                            |  |  |
| 2802 | Layer |  | 2 |      | Natural. Firm light yellowish brown with patches of white and gravel inclusions, silty sand |  |  |

### Trench 29

|   |  |  |  |  |                |  |     |
|---|--|--|--|--|----------------|--|-----|
| General description   |  |  |  |  | Orientation    |  | E-W |
| Trench devoid of archaeology. Trench consists of ploughsoil overlying a sandy gravel natural. |  |  |  |  | Length (m)     |  | 30  |
|   |  |  |  |  | Width (m)      |  | 2.2 |
|   |  |  |  |  | Avg. depth (m) |  | 0.3 |

| Context No. | Type  | Fill Of | Width (m) | Depth (m) | Description  | Finds | Date |
|-------------|-------|---------|-----------|-----------|--|-------|------|
| 2900        | Layer |         |           | 0.3       | Ploughsoil. Loose brownish grey sandy silt.                  |       |      |
| 2901        | Layer |         |           |           | Natural. Loose light orange-brown and white sand and gravel. | Slag  |      |

### Trench 30

|   |  |  |  |  |                |  |       |
|---|--|--|--|--|----------------|--|-------|
| General description   |  |  |  |  | Orientation    |  | NW-SE |
| Trench devoid of archaeology. Trench consists of ploughsoil and subsoil overlying a sandy gravel natural. |  |  |  |  | Length (m)     |  | 30    |
|   |  |  |  |  | Width (m)      |  | 2     |
|   |  |  |  |  | Avg. depth (m) |  | 0.45  |

| Context No. | Type  | Fill Of | Width (m) | Depth (m) | Description  | Finds | Date |
|-------------|-------|---------|-----------|-----------|--|-------|------|
| 3000        | Layer |         | 2         | 0.25      | Ploughsoil. Loose mid brownish grey sandy silt   |       |      |
| 3001        | Layer |         | 2         | 0.2       | Subsoil. Firm yellowish brown with gravel inclusions, silty sand                         |       |      |
| 3002        | Layer |         | 2         |           | Natural. Firm light yellowish brown with white patches and gravel inclusions, silty sand |       |      |

### Trench 31

|  |  |  |  |  |                |  |       |
|--|--|--|--|--|----------------|--|-------|
| General description  |  |  |  |  | Orientation    |  | NE-SW |
| Trench revealed two ditches and one pit. Trench consists of ploughsoil and subsoil overlying a sandy gravel natural. |  |  |  |  | Length (m)     |  | 59.4  |
|  |  |  |  |  | Width (m)      |  | 2     |
|  |  |  |  |  | Avg. depth (m) |  | 0.4   |

| Context No. | Type  | Fill Of | Width (m) | Depth (m) | Description   | Finds | Date   |
|-------------|-------|---------|-----------|-----------|---|-------|--------|
| 3100        | Layer |         | 2         | 0.19      | Ploughsoil. Loose brownish grey sandy silt                        |       |        |
| 3101        | Layer |         | 2         | 0.21      | Subsoil. Firm yellowish brown sandy clay                          |       |        |
| 3102        | Layer |         | 2         |           | Natural. Soft light yellowish brown sandy gravels.                |       |        |
| 3103        | Cut   |         | 9.96      | 0.17      | Pit   |       |        |
| 3104        | Fill  | 3103    | 2.96      | 0.17      | Primary Fill. Friable light yellowish brown silty sand.           |       |        |
| 3105        | Cut   |         | 1.3       | 0.34      | Ditch   |       |        |
| 3106        | Fill  | 3105    | 1.3       | 0.16      | Secondary Fill. Mid Greyish brown gravelly sand, loose.           |       |        |
| 3107        | Fill  |         | 0.8       | 0.18      | Primary Fill. Light greyish yellow sand, compact.                 |       |        |
| 3108        | Cut   |         |           |           | Natural Feature. Rooting. Mottled dark reddish grey gravelly sand |       |        |
| 3109        | Cut   |         | 1.3       | 0.38      | Ditch   |       |        |
| 3110        | Fill  | 3109    | 1.1       | 0.2       | Primary Fill. Mixed compact brownish yellow clayey sand           | Pot   | C13–15 |
| 3111        | Fill  | 3109    | 1.1       | 0.18      | Secondary Fill. Soft mid reddish brown silty sand                 |       |        |

### Trench 32

|  |                |       |
|--|----------------|-------|
| General description  | Orientation    | NE-SW |
| Trench revealed two ditches. Trench consists of ploughsoil and subsoil overlying a sandy gravel natural. | Length (m)     | 37    |
|  | Width (m)      | 2     |
|  | Avg. depth (m) | 0.45  |

| Context No. | Type  | Fill Of | Width (m) | Depth (m) | Description   | Finds | Date |
|-------------|-------|---------|-----------|-----------|---|-------|------|
| 3200        | Layer |         | 2         | 0.25      | Ploughsoil. Loose brownish grey sandy silt          |       |      |
| 3201        | Layer |         | 2         | 0.2       | Subsoil. Yellowish brown sandy clay                 |       |      |
| 3202        | Layer |         |           |           | Natural. light yellowish brown sandy gravels.       |       |      |
| 3203        | Cut   |         | 1         | 0.28      | Ditch   |       |      |
| 3204        | Fill  | 3203    | 1         | 0.28      | Primary Fill. soft light greyish yellow silty sand. |       |      |
| 3205        | Cut   |         | 1         | 0.19      | Ditch   |       |      |

|      |      |      |   |      |   |  |  |
|------|------|------|---|------|---|--|--|
| 3206 | Fill | 3205 | 1 | 0.19 | Primary Fill. Loose light yellowish brown sandy gravel. |  |  |
|------|------|------|---|------|---|--|--|

### Trench 33

|   |  |  |  |  |                |  |       |
|---|--|--|--|--|----------------|--|-------|
| General description   |  |  |  |  | Orientation    |  | NW-SE |
| Trench revealed one ditch. Trench consists of a ploughsoil, and subsoil overlying a sandy gravel natural. |  |  |  |  | Length (m)     |  | 45    |
|   |  |  |  |  | Width (m)      |  | 2     |
|   |  |  |  |  | Avg. depth (m) |  | 0.55  |

| Context No. | Type  | Fill Of | Width (m) | Depth (m) | Description   | Finds | Date  |
|-------------|-------|---------|-----------|-----------|---|-------|-------|
| 3300        | Layer |         | 2         | 0.3       | Ploughsoil. Loose brownish grey sandy silt                                |       |       |
| 3301        | Layer |         | 2         | 0.25      | Subsoil. Yellowish brown sandy clay                                       |       |       |
| 3302        | Layer |         | 2         |           | Natural. Light yellowish brown sandy gravels                              |       |       |
| 3303        | Cut   |         | 0.86      | 0.18      | Ditch   |       |       |
| 3304        | Fill  | 3303    | 0.86      | 0.08      | Secondary Fill. Moderately compact mottled brownish grey silty sand. <S1> | Pot   | Roman |
| 3305        | Fill  | 3303    | 0.55      | 0.03      | Tertiary Fill. Moderately friable dark grey silty sand.                   |       |       |
| 3306        | Fill  | 3303    | 0.68      | 0.07      | Primary Fill. Moderately friable light yellow silty sand                  |       |       |

### Trench 34

|  |  |  |  |  |                |  |      |
|--|--|--|--|--|----------------|--|------|
| General description  |  |  |  |  | Orientation    |  | E-W  |
| Trench revealed one pit and one ditch. Trench consists of ploughsoil and subsoil overlying a sandy gravel natural. |  |  |  |  | Length (m)     |  | 30   |
|  |  |  |  |  | Width (m)      |  | 2    |
|  |  |  |  |  | Avg. depth (m) |  | 0.25 |

| Context No. | Type  | Fill Of | Width (m) | Depth (m) | Description   | Finds | Date |
|-------------|-------|---------|-----------|-----------|---|-------|------|
| 3400        | Layer |         | 2         | 0.22      | Ploughsoil. Loose mid brownish grey sandy silt            |       |      |
| 3401        | Layer |         | 2         | 0.06      | Subsoil. Yellowish brown sandy clay                       |       |      |
| 3402        | Layer |         | 2         |           | Natural. light yellowish brown sandy gravels              |       |      |
| 3403        | Cut   |         | 0.4       | 0.08      | Pit. Possible pit   |       |      |
| 3404        | Fill  | 3403    | 0.4       | 0.08      | Primary Fill. Mottled Light grey, friable sand, no finds. |       |      |



|  |       |         |           |           |   |       |      |
|--|-------|---------|-----------|-----------|---|-------|------|
| 3405   | Cut   |         | 1.29      | 0.18      | Ditch   |       |      |
| 3406   | Fill  | 3405    | 1.29      | 0.18      | Primary Fill. Soft greyish brown sandy silt.  |       |      |
| <b>Trench 35</b>   |       |         |           |           |   |       |      |
| General description  |       |         |           |           | Orientation                                   |       | E-W  |
| Trench revealed one ditch. Trench consists of ploughsoil and subsoil overlying a sandy gravel natural.               |       |         |           |           | Length (m)                                    |       | 30   |
|  |       |         |           |           | Width (m)                                     |       | 2    |
|  |       |         |           |           | Avg. depth (m)                                |       | 0.4  |
| Context No.  | Type  | Fill Of | Width (m) | Depth (m) | Description                                   | Finds | Date |
| 3500   | Layer |         | 2         | 0.25      | Ploughsoil. Loose brownish grey sandy silt.   |       |      |
| 3501   | Layer |         | 2         | 0.15      | Subsoil. firm yellowish brown sandy clay.     |       |      |
| 3502   | Layer |         | 2         |           | Natural. light yellowish brown sandy gravels. |       |      |
| 3503   | Cut   |         | 0.5       | 0.14      | Ditch   |       |      |
| 3504   | Fill  | 3503    | 0.5       | 0.14      | Primary Fill. soft orange-brown silty sand.   |       |      |
| <b>Trench 37</b>   |       |         |           |           |   |       |      |
| General description  |       |         |           |           | Orientation                                   |       | N-S  |
| Trench devoid of archaeology. Consists of ploughsoil and subsoil overlying natural geology of sandy clay and gravel. |       |         |           |           | Length (m)                                    |       | 30   |
|  |       |         |           |           | Width (m)                                     |       | 2    |
|  |       |         |           |           | Avg. depth (m)                                |       | 0.44 |
| Context No.  | Type  | Fill Of | Width (m) | Depth (m) | Description                                   | Finds | Date |
| 3700   | Layer |         |           | 0.32      | Ploughsoil. Dark greyish brown silty clay.    |       |      |
| 3701   | Layer |         |           | 0.12      | Subsoil. Dark reddish brown silty clay.       |       |      |
| 3702   | Layer |         |           |           | Natural. Reddish brown sandy clay and gravel. |       |      |
| <b>Trench 38</b>   |       |         |           |           |   |       |      |
| General description  |       |         |           |           | Orientation                                   |       | E-W  |
| Trench devoid of archaeology. Consists of ploughsoil and subsoil overlying natural geology of sandy clay and gravel. |       |         |           |           | Length (m)                                    |       | 30   |
|  |       |         |           |           | Width (m)                                     |       | 2    |
|  |       |         |           |           | Avg. depth (m)                                |       | 0.45 |
| Context No.  | Type  | Fill Of | Width (m) | Depth (m) | Description                                   | Finds | Date |
| Context No.  | Type  | Fill Of | Width (m) | Depth (m) | Description                                   | Finds | Date |

|      |       |  |  |      |   |  |  |
|------|-------|--|--|------|---|--|--|
| 3800 | Layer |  |  | 0.3  | Ploughsoil. Dark greyish brown silty clay.    |  |  |
| 3801 | Layer |  |  | 0.15 | Subsoil. Greyish brown silty clay.            |  |  |
| 3802 | Layer |  |  |      | Natural. Reddish brown sandy clay and gravel. |  |  |
| 3803 | Cut   |  |  |      | Natural Feature                               |  |  |

### Trench 39

|   |                |      |
|---|----------------|------|
| General description   | Orientation    | N-S  |
| Trench devoid of archaeology. Consists of ploughsoil and subsoil overlying natural geology of sandy clay. | Length (m)     | 30   |
|   | Width (m)      | 2    |
|   | Avg. depth (m) | 0.44 |

| Context No. | Type  | Fill Of | Width (m) | Depth (m) | Description                                | Finds | Date |
|-------------|-------|---------|-----------|-----------|--|-------|------|
| 3900        | Layer |         |           | 0.3       | Ploughsoil. Dark greyish brown silty clay. |       |      |
| 3901        | Layer |         |           | 0.14      | Subsoil. Reddish brown silty clay.         |       |      |
| 3902        | Layer |         |           |           | Natural. Reddish brown sandy clay.         |       |      |

### Trench 40

|   |                |     |
|---|----------------|-----|
| General description   | Orientation    | E-W |
| Trench contains two pits. Trench consists of ploughsoil and subsoil overlying clay geology. | Length (m)     | 30  |
|   | Width (m)      | 2   |
|   | Avg. depth (m) | 0.5 |

| Context No. | Type  | Fill Of | Width (m) | Depth (m) | Description  | Finds | Date     |
|-------------|-------|---------|-----------|-----------|--|-------|----------|
| 4000        | Layer |         |           | 0.23      | Ploughsoil. Brownish grey sandy clay.  |       |          |
| 4001        | Layer |         |           |           | Natural. Reddish brown sandy clay  |       |          |
| 4002        | Cut   |         | 0.8       | 0.22      | Pit  |       |          |
| 4003        | Fill  |         | 0.8       | 0.22      | Primary Fill. Greyish brown sandy clay with frequent charcoal inclusions on surface. |       |          |
| 4004        | Cut   |         | 1.3       | 0.5       | Pit  |       |          |
| 4005        | Layer |         |           | 0.32      | Subsoil. Soft, compact greyish brown sandy clay.                                     | Flint | PH (res) |
| 4006        | Fill  | 4004    | 1.1       | 0.26      | Secondary Fill. Greyish orange sandy clay with manganese inclusions.                 |       |          |

### Trench 41

| General description   |       |         |           |           | Orientation   |       | E-W  |
|---|-------|---------|-----------|-----------|---|-------|------|
| Trench revealed two ditches and one posthole. Consists of ploughsoil and subsoil overlying natural geology of sandy clay. |       |         |           |           | Length (m)  |       | 30   |
|   |       |         |           |           | Width (m)   |       | 2    |
|   |       |         |           |           | Avg. depth (m)  |       | 0.46 |
| Context No.   | Type  | Fill Of | Width (m) | Depth (m) | Description   | Finds | Date |
| 4100  | Layer |         |           | 0.28      | Ploughsoil. Dark greyish brown silty clay.                |       |      |
| 4101  | Layer |         |           | 0.18      | Subsoil. Greyish brown silty clay.                        |       |      |
| 4102  | Layer |         |           |           | Natural. Reddish brown sandy clay and gravel.             |       |      |
| 4103  | Cut   |         | 0.40      | 0.07      | Ditch. Probably crop mark.                                |       |      |
| 4104  | Fill  | 4103    |           |           | Secondary Fill. Greyish red Sandy silt                    |       |      |
| 4105  | Cut   |         | 0.55      | 0.05      | Ditch. Crop mark  |       |      |
| 4106  | Fill  | 4105    |           |           | Secondary Fill. Greyish red Sandy silt Natural deposition |       |      |
| 4107  | Cut   |         | 0.60      | 0.14      | Posthole  |       |      |
| 4108  | Fill  | 4107    |           |           | Secondary Fill. Greyish red sandy silt Natural deposition |       |      |

#### Trench 42

| General description  |       |         |           |           | Orientation                                   |       | NW-SE  |
|--|-------|---------|-----------|-----------|---|-------|--------|
| Trench revealed three possible pits. It consists of ploughsoil and subsoil overlying clay and gravel geology |       |         |           |           | Length (m)                                    |       | 30     |
|  |       |         |           |           | Width (m)                                     |       | 2.1    |
|  |       |         |           |           | Avg. depth (m)                                |       | 0.5    |
| Context No.  | Type  | Fill Of | Width (m) | Depth (m) | Description                                   | Finds | Date   |
| 4200   | Layer |         | 0.3       |           | Ploughsoil. Greyish brown Sandy clay          |       |        |
| 4201   | Layer |         |           | 0.2       | Subsoil. Orange-brown Sandy clay              |       |        |
| 4202   | Layer |         |           |           | Natural. Light orange-brown Sandy clay        |       |        |
| 4203   | Cut   |         | 0.32      | 0.06      | Pit   |       |        |
| 4204   | Fill  | 4203    | 0.32      | 0.06      | Secondary Fill. Soft greyish brown Sandy clay | Flint | PH     |
| 4205   | Cut   |         | 0.76      | 0.38      | Pit   |       |        |
| 4206   | Fill  | 4205    | 0.76      | 0.38      | Secondary Fill. Soft greyish brown Silty clay | Pot   | MBA-IA |
| 4207   | Cut   |         | 1         | 0.31      | Ditch. Terminus                               |       |        |

|      |      |      |      |      |  |                  |        |
|------|------|------|------|------|--|------------------|--------|
| 4208 | Fill | 4207 | 0.98 | 0.15 | Secondary Fill. Dark brownish grey sandy silt with frequent grit and gravels | Pot, animal bone | C13-15 |
| 4209 | Fill | 4207 | 0.22 | 0.02 | Primary Fill. soft Light yellowish brown silty clay                          |                  |        |
| 4210 | Fill | 4207 | 0.68 | 0.18 | Secondary Fill. Light yellowish grey soft sandy silt.                        |                  |        |

### Trench 43

|  |  |  |  |  |                |  |       |
|--|--|--|--|--|----------------|--|-------|
| General description  |  |  |  |  | Orientation    |  | NE-SW |
| Trench contains five postholes and a ditch. Trench consists of ploughsoil and subsoil overlying clay and gravel geology. |  |  |  |  | Length (m)     |  | 30    |
|  |  |  |  |  | Width (m)      |  | 2.1   |
|  |  |  |  |  | Avg. depth (m) |  | 0.46  |

| Context No. | Type  | Fill Of | Width (m) | Depth (m) | Description  | Finds       | Date |
|-------------|-------|---------|-----------|-----------|--|-------------|------|
| 4300        | Layer |         |           | 0.35      | Ploughsoil. Greyish brown Sandy clay                   |             |      |
| 4301        | Layer |         |           | 0.11      | Subsoil. Orange-brown Sandy clay                       |             |      |
| 4302        | Layer |         |           |           | Natural. Light orange-brown Sandy clay                 |             |      |
| 4303        | Cut   |         | 0.4       | 0.06      | Posthole   |             |      |
| 4304        | Fill  | 4303    | 0.35      | 0.06      | Secondary Fill. Greyish brown Soft Silty clay          |             |      |
| 4305        | Cut   |         | 0.3       | 0.1       | Posthole   |             |      |
| 4306        | Fill  | 4305    | 0.3       | 0.1       | Secondary Fill. Greyish brown Soft Silty clay          |             |      |
| 4307        | Cut   |         | 0.4       | 0.08      | Posthole   |             |      |
| 4308        | Fill  | 4307    | 0.4       | 0.08      | Secondary Fill. Greyish brown Soft Sandy clay          |             |      |
| 4309        | Cut   |         | 0.4       | 0.06      | Posthole   |             |      |
| 4310        | Fill  | 4309    | 0.4       | 0.06      | Secondary Fill. Greyish brown Very soft Silty clay     |             |      |
| 4311        | Cut   |         | 0.8       | 0.22      | Ditch  |             |      |
| 4312        | Fill  | 4311    | 0.8       | 0.22      | Secondary Fill. Greyish brown Moderate soft Silty clay | animal bone |      |
| 4313        | Cut   |         | 0.25      | 0.1       | Posthole   |             |      |
| 4314        | Fill  | 4313    | 0.25      | 0.1       | Secondary Fill. Greyish brown Soft Sandy clay          |             |      |

### Trench 44

|                     |  |  |  |  |             |  |     |
|---------------------|--|--|--|--|-------------|--|-----|
| General description |  |  |  |  | Orientation |  | N-S |
|                     |  |  |  |  | Length (m)  |  | 30  |

| Trench contains a terminus and two natural features. Trench consists of ploughsoil overlying clay natural. |       |         |           |           | Width (m)  | 2          |        |
|--|-------|---------|-----------|-----------|--|------------|--------|
|  |       |         |           |           | Avg. depth (m)   | 0.3        |        |
| Context No.  | Type  | Fill Of | Width (m) | Depth (m) | Description  | Finds      | Date   |
| 4400   | Layer |         |           | 0.32      | Ploughsoil. Mid greyish brown silty clay.                            |            |        |
| 4401   | Layer |         |           |           | Subsoil. Mid greyish brown silty sand                                |            |        |
| 4402   | Layer |         |           |           | Natural. Brownish orange sandy clay natural                          |            |        |
| 4403   | Cut   |         | 2.15      | 0.08      | Natural Feature. Kidney shaped pit. Light brownish grey clayey silt. |            |        |
| 4404   | Cut   |         | 1.36      | 0.15      | Natural Feature. Light greyish brown clayey silt                     |            |        |
| 4405   | Cut   |         | 0.56      | 0.22      | Ditch. Terminus of NW/SE ditch.                                      |            |        |
| 4406   | Fill  | 4405    | 0.56      | 0.22      | Primary Fill. Light brownish grey mod compact clayey silt            | Pot, flint | MBA-IA |

#### Trench 45

| General description  |       |         |           |           | Orientation                                   | N-S         |      |
|--|-------|---------|-----------|-----------|---|-------------|------|
| Trench revealed one ditch. Trench consists of ploughsoil and subsoil overlying natural sandy clay geology. |       |         |           |           | Length (m)                                    | 30          |      |
|  |       |         |           |           | Width (m)                                     | 2           |      |
|  |       |         |           |           | Avg. depth (m)                                | 0.48        |      |
| Context No.  | Type  | Fill Of | Width (m) | Depth (m) | Description                                   | Finds       | Date |
| 4500   | Layer |         |           | 0.3       | Ploughsoil. Dark greyish brown silty clay.    |             |      |
| 4501   | Layer |         |           | 0.18      | Subsoil. Dark reddish brown silty clay.       |             |      |
| 4502   | Layer |         |           |           | Natural. Reddish brown sandy clay and gravel. |             |      |
| 4503   | Cut   |         | 1.42      | 0.4       | Ditch   |             |      |
| 4504   | Fill  | 4503    | 1.42      | 0.4       | Secondary Fill. Greyish brown clayey sand     | Animal bone |      |

#### Trench 46

| General description  |      |         |           |           | Orientation    | NW-SE |      |
|--|------|---------|-----------|-----------|----------------|-------|------|
| Trench contains two ditches, a pit and a natural feature. Trench consists of ploughsoil and subsoil overlying clay and gravel geology. |      |         |           |           | Length (m)     | 30    |      |
|  |      |         |           |           | Width (m)      | 2.1   |      |
|  |      |         |           |           | Avg. depth (m) | 0.45  |      |
| Context No.  | Type | Fill Of | Width (m) | Depth (m) | Description    | Finds | Date |

|      |       |      |      |      |  |             |  |
|------|-------|------|------|------|--|-------------|--|
| 4600 | Layer |      |      | 0.28 | Ploughsoil. Greyish brown Sandy clay   |             |  |
| 4601 | Layer |      |      | 0.17 | Subsoil. Orange-brown Sandy clay   |             |  |
| 4602 | Layer |      |      |      | Natural. Light orange-brown Sandy clay   |             |  |
| 4603 | Cut   |      | 0.51 | 0.13 | Ditch. N-S   |             |  |
| 4604 | Fill  | 4603 | 0.51 | 0.13 | Primary Fill. Light brownish grey clayey silt.                                       |             |  |
| 4605 | Cut   |      | 0.53 | 0.18 | Ditch. N/S   |             |  |
| 4606 | Fill  | 4605 | 0.53 | 0.18 | Primary Fill. Light brownish grey with freq. Charcoal inclusions. Clayey silt. <S26> | Burnt Flint |  |
| 4607 | Cut   |      | 0.47 | 0.08 | Pit  |             |  |
| 4608 | Fill  | 4607 | 0.46 | 0.08 | Primary Fill. Dark greyish brown clayey silt   |             |  |
| 4609 | Layer |      | 0.6  |      | Natural. Natural linear. Light reddish grey sandy silt                               |             |  |

#### Trench 47

|  |                |     |
|--|----------------|-----|
| General description  | Orientation    | N-S |
| Trench contains two parallel ditches and a pit. Trench consists of ploughsoil and subsoil overlying clay and gravel geology. | Length (m)     | 30  |
|  | Width (m)      | 2.1 |
|  | Avg. depth (m) | 0.5 |

| Context No. | Type                | Fill Of | Width (m) | Depth (m) | Description  | Findings | Date |
|-------------|---------------------|---------|-----------|-----------|--|----------|------|
| 4700        | Layer               |         |           | 0.3       | Ploughsoil. Greyish brown Sandy clay                   |          |      |
| 4701        | Layer               |         |           | 0.2       | Subsoil. Orange-brown Sandy clay                       |          |      |
| 4702        | Layer               |         |           |           | Natural. Light orange-brown Sandy clay                 |          |      |
| 4703        | Unexcavated feature |         | 1.05      |           | Pit. Sub ovular. Brownish grey sandy silt. Cut by 4706 | CBM      | PMed |
| 4704        | Cut                 |         | 1.1       | 0.23      | Ditch. NW/SE   |          |      |
| 4705        | Fill                | 4704    | 1.1       | 0.23      | Primary Fill. Dark brownish grey clayey silt           |          |      |
| 4706        | Cut                 |         | 1.07      | 0.22      | Ditch. E/W   |          |      |
| 4707        | Fill                | 4706    | 1.07      | 0.22      | Primary Fill. Brownish grey clayey silt                |          |      |

#### Trench 48

|                     |             |     |
|---------------------|-------------|-----|
| General description | Orientation | E-W |
|---------------------|-------------|-----|

| Trench contains three natural features and a pit. Trench consists of ploughsoil overlying clay geology. |       |         |           |           | Length (m)  |       | 30   |
|---|-------|---------|-----------|-----------|---|-------|------|
|   |       |         |           |           | Width (m)   |       | 2    |
|   |       |         |           |           | Avg. depth (m)  |       | 0.3  |
| Context No.   | Type  | Fill Of | Width (m) | Depth (m) | Description   | Finds | Date |
| 4800  | Layer |         |           | 0.33      | Ploughsoil. Greyish brown silty clay  |       |      |
| 4801  | Layer |         |           |           | Natural. Reddish brown sandy clay   |       |      |
| 4802  | Cut   |         |           |           | Natural Feature. Irregular cut with irregular roughly concave sides and base                              |       |      |
| 4803  | Cut   |         |           |           | Natural Feature. Roughly sub circular cut with irregular roughly concave sides and base,                  |       |      |
| 4804  | Cut   |         | 0.52      | 0.26      | Pit. Sub-circular cut with moderately sloping concave sides and base.                                     |       |      |
| 4805  | Fill  | 4804    | 0.52      | 0.26      | Secondary Fill. Moderately compact greyish brown silty clay with occasional sub-angular stones. No finds. |       |      |
| 4806  | Cut   |         |           |           | Natural Feature.  |       |      |
| 4807  | Cut   |         | 0.4       | 0.23      | Natural Feature Dark greyish sandy silt   |       |      |

#### Trench 49

| General description  |       |         |           |           | Orientation   |       | E-W  |
|--|-------|---------|-----------|-----------|---|-------|------|
| Trench devoid of archaeology. Consists of ploughsoil and subsoil overlying natural geology of sandy clay and gravel. |       |         |           |           | Length (m)  |       | 30   |
|  |       |         |           |           | Width (m)   |       | 2    |
|  |       |         |           |           | Avg. depth (m)  |       | 0.45 |
| Context No.  | Type  | Fill Of | Width (m) | Depth (m) | Description   | Finds | Date |
| 4900   | Layer |         |           | 0.28      | Ploughsoil. Dark greyish brown silty clay.                            |       |      |
| 4901   | Layer |         |           | 0.17      | Subsoil. Dark reddish brown silty clay.                               |       |      |
| 4902   | Layer |         |           |           | Natural. Reddish brown sandy clay and gravel.                         |       |      |
| 4903   | Cut   |         | 0.46      | 0.11      | Natural Feature. Probable tree-throw. Light greyish brown sandy silt. |       |      |

| <b>Trench 50</b>  |                     |         |           |           |   |       |         |
|---|---------------------|---------|-----------|-----------|---|-------|---------|
| General description   |                     |         |           |           | Orientation   |       | NNW-SSE |
| Trench contains a large tree bole feature. It consists of ploughsoil and subsoil overlying clay and sand geology.   |                     |         |           |           | Length (m)  |       | 30      |
|   |                     |         |           |           | Width (m)   |       | 2.1     |
|   |                     |         |           |           | Avg. depth (m)  |       | 0.66    |
| Context No.   | Type                | Fill Of | Width (m) | Depth (m) | Description   | Finds | Date    |
| 5000  | Layer               |         |           | 0.33      | Ploughsoil. Greyish brown Sandy clay                          |       |         |
| 5001  | Layer               |         |           | 0.27      | Subsoil. Orange-brown Silty clay                              |       |         |
| 5002  | Layer               |         |           |           | Natural. Light orange-brown Sandy clay Gravel inclusions      |       |         |
| 5003  | Cut                 |         |           |           | Natural Feature. Tree bole                                    |       |         |
| <b>Trench 51</b>  |                     |         |           |           |   |       |         |
| General description   |                     |         |           |           | Orientation   |       | NE-SW   |
| Trench contains two ditches and a pit. Trench consists of ploughsoil and subsoil overlying clay and gravel geology. |                     |         |           |           | Length (m)  |       | 30      |
|   |                     |         |           |           | Width (m)   |       | 2.1     |
|   |                     |         |           |           | Avg. depth (m)  |       | 0.6     |
| Context No.   | Type                | Fill Of | Width (m) | Depth (m) | Description   | Finds | Date    |
| 5100  | Layer               |         |           | 0.35      | Ploughsoil. Greyish brown Sandy clay                          |       |         |
| 5101  | Layer               |         |           | 0.31      | Subsoil. Orange-brown Silty clay                              |       |         |
| 5102  | Layer               |         |           |           | Natural. Light orange-brown Sandy clay Gravel inclusions      |       |         |
| 5103  | Unexcavated feature |         | 1.34      |           | Ditch. Dark brown/black clayey silt. Same as 6203             |       |         |
| 5104  | Cut                 |         | 0.56      | 0.1       | Ditch. N-S  |       |         |
| 5105  | Fill                | 5104    | 0.56      | 0.1       | Primary Fill. Moderately compact light grey sandy silt 2235/6 |       |         |
| 5106  | Cut                 | 5106    | 2.98      |           | Natural Feature. Light yellowish grey silty sand              |       |         |
| <b>Trench 52</b>  |                     |         |           |           |   |       |         |
| General description   |                     |         |           |           | Orientation   |       | NW-SE   |
| Trench devoid of archaeology. Plough soil and subsoil overlying natural.  |                     |         |           |           | Length (m)  |       | 30      |
|   |                     |         |           |           | Width (m)   |       | 2.1     |
|   |                     |         |           |           | Avg. depth (m)  |       | 0.55    |
| Context No.   | Type                | Fill Of | Width (m) | Depth (m) | Description   | Finds | Date    |



|      |       |  |     |      |  |  |  |
|------|-------|--|-----|------|--|--|--|
| 5200 | Layer |  | 2.1 | 0.3  | Ploughsoil   |  |  |
| 5201 | Layer |  | 2.1 | 0.15 | Subsoil. Orangish brown silty clay with occasional sub-angular stones. |  |  |
| 5202 | Layer |  | 2.1 | 0.1  | Natural. Brownish orange silty clay with patches of gravel.            |  |  |

### Trench 53

| General description   |       |         |           |           | Orientation  |       | E-W  |
|---|-------|---------|-----------|-----------|--|-------|------|
| Trench contains two natural features. Trench consists of ploughsoil and subsoil overlaying gravel and clay geology. |       |         |           |           | Length (m)   |       | 30   |
|   |       |         |           |           | Width (m)  |       | 2.1  |
|   |       |         |           |           | Avg. depth (m)   |       | 0.45 |
| Context No.   | Type  | Fill Of | Width (m) | Depth (m) | Description  | Finds | Date |
| 5300  | Layer |         | 2.1       | 0.28      | Ploughsoil   |       |      |
| 5301  | Layer |         | 2.1       | 0.15      | Subsoil. Orangish brown silty clay with occasional sub-angular stones.                         |       |      |
| 5302  | Layer |         | 2.1       | 0.02      | Natural. Brownish orange silty clay with patches of mid brownish yellow silty sand and gravel. |       |      |
| 5303  | Cut   |         | 1.83      | 0.36      | Natural Feature. Sub-circular. Light grey/dark brown clayey sand                               |       |      |
| 5304  | Layer |         | 1.3       |           | Natural. Dark reddish grey clayey silt   |       |      |

### Trench 54

| General description   |       |         |           |           | Orientation                                   |       | N-S  |
|---|-------|---------|-----------|-----------|---|-------|------|
| Trench revealed one pit. Consists of ploughsoil and subsoil overlying natural geology of sandy clay and gravel. |       |         |           |           | Length (m)                                    |       | 30   |
|   |       |         |           |           | Width (m)                                     |       | 2    |
|   |       |         |           |           | Avg. depth (m)                                |       | 0.52 |
| Context No.   | Type  | Fill Of | Width (m) | Depth (m) | Description                                   | Finds | Date |
| 5400  | Void  |         |           |           |   |       |      |
| 5400  | Layer |         |           | 0.31      | Ploughsoil. Dark greyish brown silty clay.    |       |      |
| 5401  | Layer |         |           | 0.21      | Subsoil. Yellowish brown silty clay.          |       |      |
| 5402  | Layer |         |           |           | Natural. Reddish brown sandy clay and gravel. |       |      |
| 5403  | Cut   |         | 0.54      | 0.26      | Pit   |       |      |

| 5404   | Fill  | 5403    | 0.54      | 0.26      | Deliberate Backfill. Greyish brown sandy silt . <S29>                  | Pot   | Prehistoric |
|--|-------|---------|-----------|-----------|--|-------|-------------|
| <b>Trench 55</b>   |       |         |           |           |  |       |             |
| General description  |       |         |           |           | Orientation  |       | E-W         |
| Trench contains a ditch. Trench consists of ploughsoil and subsoil overlying clay geology.   |       |         |           |           | Length (m)   |       | 30          |
|  |       |         |           |           | Width (m)  |       | 2           |
|  |       |         |           |           | Avg. depth (m)   |       | 0.5         |
| Context No.  | Type  | Fill Of | Width (m) | Depth (m) | Description  | Finds | Date        |
| 5500   | Layer |         |           | 0.35      | Ploughsoil. Dark grey sandy silt topsoil                               |       |             |
| 5501   | Layer |         |           | 0.22      | Subsoil. Dark reddish brown clayey silt subsoil                        |       |             |
| 5502   | Layer |         |           |           | Natural. Orange-brown gravelly sandy clay natural                      |       |             |
| 5503   | Cut   |         | 0.41      | 0.11      | Ditch. N-S   |       |             |
| 5504   | Fill  | 5503    | 0.41      | 0.11      | Primary Fill. Mod compact light grey sandy silt 2232/4                 |       |             |
| <b>Trench 56</b>   |       |         |           |           |  |       |             |
| General description  |       |         |           |           | Orientation  |       | NW-SE       |
| Trench contains two ditches, a pit and a natural feature. Trench consists of ploughsoil and subsoil overlying clay and gravel geology. |       |         |           |           | Length (m)   |       | 30          |
|  |       |         |           |           | Width (m)  |       | 2.1         |
|  |       |         |           |           | Avg. depth (m)   |       | 0.69        |
| Context No.  | Type  | Fill Of | Width (m) | Depth (m) | Description  | Finds | Date        |
| 5600   | Layer |         | 2.1       | 0.3       | Ploughsoil   |       |             |
| 5601   | Layer |         | 2.1       | 0.3       | Subsoil. Orangish brown silty clay with occasional sub-angular stones. |       |             |
| 5602   | Layer |         | 2.1       | 0.09      | Natural. Brownish orange silty clay with patches of gravel.            |       |             |
| 5603   | Cut   |         | 0.96      | 0.3       | Ditch. NE-SW   |       |             |
| 5604   | Fill  | 5603    | 0.96      | 0.3       | Primary Fill. Mod compact light brownish grey clayey silt 2330/1       |       |             |
| 5605   | Cut   |         | 0.35      | 0.06      | Natural Feature. Curvilinear. Light reddish grey clayey silt           |       |             |
| 5606   | Cut   |         | 1.05      | 0.13      | Natural Feature. Ovular pit. Dark reddish brown sandy silt             |       |             |

| 5607   | Unexcavated feature |         | 0.89      |           | Ditch. NW/SE. Dark reddish brown clayey silt   |       |       |
|--|---------------------|---------|-----------|-----------|--|-------|-------|
| <b>Trench 57</b>   |                     |         |           |           |  |       |       |
| General description  |                     |         |           |           | Orientation  |       | NE-SW |
| Trench contains two natural features. Trench consists of ploughsoil and subsoil overlaying sand and clay geology.              |                     |         |           |           | Length (m)   |       | 30    |
|  |                     |         |           |           | Width (m)  |       | 2.1   |
|  |                     |         |           |           | Avg. depth (m)   |       | 0.6   |
| Context No.  | Type                | Fill Of | Width (m) | Depth (m) | Description  | Finds | Date  |
| 5700   | Layer               |         | 2.1       | 0.4       | Ploughsoil. Dark grey-brown sandy silt.  |       |       |
| 5701   | Layer               |         | 2.1       | 0.18      | Natural. Brownish orange silty clay with occasional sub-angular stones                     |       |       |
| 5702   | Layer               |         | 2.1       | 0.02      | Natural. Brownish orange silty clay with patches of brownish yellow silty sand and gravel. |       |       |
| 5703   | Cut                 |         | 1.02      | 0.26      | Natural Feature. Nat pit. Dark brown clayey silt   |       |       |
| 5704   | Layer               |         | 0.31      |           | Natural. Sub circular pit. Dark reddish brown clayey silt                                  |       |       |
| <b>Trench 58</b>   |                     |         |           |           |  |       |       |
| General description  |                     |         |           |           | Orientation  |       | NW-SE |
| Trench contains a ditch and three natural features. Trench consists of ploughsoil and subsoil overlying clay and sand geology. |                     |         |           |           | Length (m)   |       | 30    |
|  |                     |         |           |           | Width (m)  |       | 2.1   |
|  |                     |         |           |           | Avg. depth (m)   |       | 0.5   |
| Context No.  | Type                | Fill Of | Width (m) | Depth (m) | Description  | Finds | Date  |
| 5800   | Layer               |         | 2.1       | 0.3       | Ploughsoil. Dark grey-brown sandy silt.  |       |       |
| 5801   | Layer               |         | 2.1       | 0.15      | Subsoil. Orangish brown silty clay with occasional sub-angular stones.                     |       |       |
| 5802   | Layer               |         | 2.1       | 0.15      | Natural. Brownish orange silty clay with occasional sub-angular stones.                    |       |       |
| 5803   | Cut                 |         | 0.84      | 0.28      | Ditch. NE-SW   |       |       |
| 5804   | Fill                | 5803    | 0.84      | 0.28      | Primary Fill. Dark greyish brown mod compact clayey silt                                   |       |       |

|      |       |      |      |      |  |  |  |
|------|-------|------|------|------|--|--|--|
| 5805 | Cut   | 5805 | 1.84 | 0.12 | Natural Feature.<br>Natural pit. Light brownish grey clayey sand |  |  |
| 5806 | Cut   |      | 0.76 | 0.16 | Natural Feature.<br>Light greyish brown clayey silt              |  |  |
| 5807 | Layer |      | 1.61 |      | Natural. Light brownish grey clayey silt                         |  |  |
| 5808 | Void  |      |      |      |  |  |  |

### Trench 59

| General description  |       |         |           |           | Orientation                                   |       | NW-SE |
|--|-------|---------|-----------|-----------|---|-------|-------|
| Trench devoid of archaeology. Consists of ploughsoil and subsoil overlying natural geology of sandy clay and gravel. |       |         |           |           | Length (m)                                    |       | 30    |
|  |       |         |           |           | Width (m)                                     |       | 2     |
|  |       |         |           |           | Avg. depth (m)                                |       | 0.5   |
| Context No.  | Type  | Fill Of | Width (m) | Depth (m) | Description                                   | Finds | Date  |
| 5900   | Layer |         |           | 0.29      | Ploughsoil. Dark greyish brown silty clay.    |       |       |
| 5901   | Layer |         |           | 0.21      | Subsoil. Yellowish brown silty clay.          |       |       |
| 5902   | Layer |         |           |           | Natural. Reddish brown sandy clay and gravel. |       |       |
| 5903   | Cut   |         | 1.22      | 0.2       | Natural Feature.<br>Greyish brown silty clay. |       |       |

### Trench 60

| General description  |       |         |           |           | Orientation  |       | NE-SW |
|--|-------|---------|-----------|-----------|--|-------|-------|
| Trench contained five possible features that were investigated and determined to be of natural origin. It consists of ploughsoil, subsoil overlying clay and gravel geology. |       |         |           |           | Length (m)   |       | 30    |
|  |       |         |           |           | Width (m)  |       | 2.1   |
|  |       |         |           |           | Avg. depth (m)   |       | 0.5   |
| Context No.  | Type  | Fill Of | Width (m) | Depth (m) | Description  | Finds | Date  |
| 6000   | Layer |         | 2.1       | 0.3       | Ploughsoil   |       |       |
| 6001   | Layer |         | 2.1       | 0.1       | Subsoil. Orangish brown silty clay with occasional sub-angular stones. |       |       |
| 6002   | Layer |         | 2.1       | 0.1       | Natural. Brownish orange silty clay with patches of gravel.            |       |       |
| 6003   | Cut   |         | 0.64      | 0.37      | Natural Feature.<br>Sub oval pit. Dark grey clayey silt                |       |       |
| 6004   | Cut   |         | 0.99      | 0.23      | Natural Feature.<br>Light brownish grey sandy silt                     |       |       |

| 6005  | Cut   |         | 0.55      | 0.12      | Natural Feature. Dark greyish brown sandy silt                         |            |        |
|---|-------|---------|-----------|-----------|--|------------|--------|
| 6006  | Cut   |         | 2.32      | 0.16      | Natural Feature. Crescent shaped pit. Light brownish grey clayey silt  |            |        |
| 6007  | Cut   |         | 1.74      | 0.24      | Natural Feature. Kidney shaped hollow. Dark brownish grey sandy silt   |            |        |
| <b>Trench 61</b>  |       |         |           |           |  |            |        |
| General description   |       |         |           |           | Orientation  |            | E-W    |
| Trench contains four pits and two linears. Trench consists of ploughsoil and subsoil overlying clay and gravel geology. |       |         |           |           | Length (m)   |            | 30     |
|   |       |         |           |           | Width (m)  |            | 2.1    |
|   |       |         |           |           | Avg. depth (m)   |            | 0.65   |
| Context No.   | Type  | Fill Of | Width (m) | Depth (m) | Description  | Finds      | Date   |
| 6100  | Layer |         | 2.1       | 0.35      | Ploughsoil   |            |        |
| 6101  | Layer |         | 2.1       | 0.2       | Subsoil. Orangish brown silty clay with occasional sub-angular stones. |            |        |
| 6102  | Layer |         | 2.1       | 0.1       | Natural. Brownish orange silty clay with patches of gravel             |            |        |
| 6103  | Cut   |         | 1.88      | 0.12      | Ring Ditch. Aligns with crop marks. Only in section.                   |            |        |
| 6104  | Fill  | 6103    | 1.88      | 0.12      | Primary Fill. Dark brown-grey clay silt.                               | Pot, flint | ENeo?  |
| 6105  | Cut   |         | 0.71      | 0.44      | Natural Feature. Curvilinear. Natural feature                          |            |        |
| 6106  | Fill  | 6105    | 0.71      | 0.44      | Primary Fill. Light greyish brown clayey silt                          | Pot        | MBA-IA |
| 6107  | Cut   |         | 0.81      | 0.21      | Ditch. N/S. Probable terminus  |            |        |
| 6108  | Fill  | 6107    | 0.81      | 0.21      | Primary Fill. Light brownish grey sandy silt                           | Flint      | PH     |
| 6109  | Cut   |         | 0.89      | 0.19      | Ditch. N/S. Probable terminus  |            |        |
| 6110  | Fill  | 6109    | 0.89      | 0.19      | Primary Fill. Light brownish grey sandy silt                           |            |        |
| 6111  | Cut   |         | 1.86      | 0.17      | Natural Feature. Natural feature. Light brownish grey sandy silt       |            |        |

|      |                     |  |      |      |  |  |  |
|------|---------------------|--|------|------|--|--|--|
| 6112 | Cut                 |  | 0.32 | 0.04 | Natural Feature. Circular natural feature. Dark greyish brown sandy silt |  |  |
| 6113 | Unexcavated feature |  | 0.85 |      | Pit. Dark orangish brown clayey silt                                     |  |  |
| 6114 | Unexcavated feature |  | 2.32 |      | Pit. Light brownish grey sandy silt                                      |  |  |
| 6115 | Layer               |  | 3.3  |      | Natural. Light grey-brown silty sand.                                    |  |  |

### Trench 62

|   |  |                |       |
|---|--|----------------|-------|
| General description   |  | Orientation    | NE-SW |
| Trench contains a ditch and a ring ditch. Trench consists of ploughsoil and subsoil overlaying gravel and clay geology. |  | Length (m)     | 30    |
|   |  | Width (m)      | 2.1   |
|   |  | Avg. depth (m) | 0.48  |

| Context No. | Type  | Fill Of | Width (m) | Depth (m) | Description   | Finds        | Date             |
|-------------|-------|---------|-----------|-----------|---|--------------|------------------|
| 6200        | Layer |         | 2.1       | 0.34      | Ploughsoil. Dark grey-brown, sandy silt   |              |                  |
| 6201        | Layer |         | 2.1       | 0.12      | Subsoil. Mottled brownish orange and mid orangish brown silty clays with occasional sub-angular stones. |              |                  |
| 6202        | Layer |         | 2.1       | 0.02      | Natural. Brownish orange silty clay with occasional sub-angular stones                                  |              |                  |
| 6203        | Cut   |         | 1.74      | 0.64      | Ditch. N-S  |              |                  |
| 6204        | Fill  | 6203    |           | 0.27      | Primary Fill. Orangish brown sandy silt   |              |                  |
| 6205        | Fill  | 6203    | 1.74      | 0.32      | Secondary Fill. Dark brown-black with deposition of natural clayey silt                                 | Flint, glass | PH (res), C19-20 |
| 6206        | Cut   |         | 0.42      | 0.08      | Pit. Sub circular   |              |                  |
| 6207        | Fill  | 6206    | 0.42      | 0.08      | Primary Fill. Dark brownish grey clayey silt  |              |                  |
| 6208        | Cut   |         | 2.57      | 0.08      | Ring Ditch. Aligns with crop marks. Only in section.  |              |                  |
| 6209        | Fill  | 6208    | 2.57      | 0.08      | Primary Fill. Dark greyish brown clayey silt with manganese inclusions. 2248/53                         |              |                  |

### Trench 63

|                     |  |             |     |
|---------------------|--|-------------|-----|
| General description |  | Orientation | E-W |
|---------------------|--|-------------|-----|

| Trench contains a pit. Trench consists of ploughsoil and subsoil overlying sand and clay geology. |       |         |           |           | Length (m)   |       | 30   |
|---|-------|---------|-----------|-----------|--|-------|------|
|   |       |         |           |           | Width (m)  |       | 2    |
|   |       |         |           |           | Avg. depth (m)   |       | 0.45 |
| Context No.   | Type  | Fill Of | Width (m) | Depth (m) | Description  | Finds | Date |
| 6300  | Layer |         |           | 0.3       | Ploughsoil. Brown clay silt.                                     |       |      |
| 6301  | Layer |         |           | 0.1       | Subsoil. Red-brown clay silt.                                    |       |      |
| 6302  | Layer |         |           |           | Natural. Red-brown silt clay.                                    |       |      |
| 6303  | Cut   |         | 0.53      | 0.19      | Pit. Sub circular  |       |      |
| 6304  | Fill  | 6303    | 0.53      | 0.19      | Deliberate Backfill. Light greyish brown mod compact clayey silt |       |      |

### Trench 64

| General description   |       |         |           |           | Orientation                                      |            | ENE-WSW |
|---|-------|---------|-----------|-----------|--|------------|---------|
| Trench revealed three ditches and one posthole. Consists of ploughsoil and subsoil overlying natural geology of sandy clay. |       |         |           |           | Length (m)                                       |            | 30      |
|   |       |         |           |           | Width (m)  |            | 2       |
|   |       |         |           |           | Avg. depth (m)                                   |            | 0.53    |
| Context No.   | Type  | Fill Of | Width (m) | Depth (m) | Description                                      | Finds      | Date    |
| 6400  | Layer |         |           | 0.34      | Ploughsoil. Dark greyish brown silty clay.       |            |         |
| 6400  | Layer |         |           | 0.19      | Subsoil. Greyish brown silty clay.               |            |         |
| 6402  | Layer |         |           |           | Natural. Reddish brown sandy clay.               |            |         |
| 6403  | Cut   |         | 0.55      | 0.33      | Ditch  |            |         |
| 6404  | Fill  | 6403    | 0.55      | 0.23      | Secondary Fill. Greyish brown clayey silt.       | Pot, Flint | Roman   |
| 6405  | Fill  | 6403    | 0.23      | 0.13      | Primary Fill. Greyish brown clayey silt.         |            |         |
| 6406  | Cut   |         | 0.52      | 0.12      | Posthole   |            |         |
| 6407  | Fill  | 6406    | 0.52      | 0.12      | Other Fill. Dark greyish brown clayey silt.      |            |         |
| 6408  | Cut   |         | 0.73      | 0.21      | Ditch  |            |         |
| 6409  | Fill  | 6408    | 0.73      | 0.07      | Secondary Fill. Greyish brown clayey silt. <S30> | Flint      |         |
| 6410  | Fill  | 6408    | 0.42      | 0.14      | Primary Fill. Greyish brown clayey silt.         |            |         |
| 6411  | Cut   |         | 0.85      | 0.28      | Ditch  |            |         |

| 6412   | Fill  | 6411    | 0.85      | 0.28      | Secondary Fill.<br>Brownish grey<br>clayey sand            |       |       |
|--|-------|---------|-----------|-----------|--|-------|-------|
| 6413   | Cut   |         |           |           | Natural Feature  |       |       |
| <b>Trench 65</b>   |       |         |           |           |  |       |       |
| General description  |       |         |           |           | Orientation  |       | NW-SE |
| Trench contains a natural feature. Trench consists of ploughsoil and subsoil overlying clay geology.                 |       |         |           |           | Length (m)   |       | 30    |
|  |       |         |           |           | Width (m)  |       | 2     |
|  |       |         |           |           | Avg. depth (m)   |       | 0.25  |
| Context No.  | Type  | Fill Of | Width (m) | Depth (m) | Description  | Finds | Date  |
| 6500   | Layer |         |           | 0.27      | Ploughsoil. Firm mid greyish brown sandy clay.             |       |       |
| 6501   | Layer |         |           |           | Natural. Reddish brown sandy clay                          |       |       |
| 6502   | Cut   |         | 2.67      | 0.07      | Natural Feature. Light brownish grey silty sand            |       |       |
| <b>Trench 66</b>   |       |         |           |           |  |       |       |
| General description  |       |         |           |           | Orientation  |       | E-W   |
| Trench contains two ditches. Trench consists of ploughsoil overlying sand and clay geology.                          |       |         |           |           | Length (m)   |       | 30    |
|  |       |         |           |           | Width (m)  |       | 2.1   |
|  |       |         |           |           | Avg. depth (m)   |       | 0.45  |
| Context No.  | Type  | Fill Of | Width (m) | Depth (m) | Description  | Finds | Date  |
| 6600   | Layer |         | 2.1       | 0.3       | Ploughsoil. Dark grey-brown silty sand.                    |       |       |
| 6601   | Layer |         | 2.1       | 0.15      | Natural. Reddish orange silty sand with patches of gravel. |       |       |
| 6602   | Cut   |         | 0.82      | 0.24      | Ditch  |       |       |
| 6603   | Fill  |         | 0.82      | 0.24      | Primary Fill. Soft, loose mid brownish grey clayey sand.   |       |       |
| 6604   | Cut   |         | 0.7       | 0.18      | Ditch  |       |       |
| 6605   | Fill  | 6604    | 0.7       | 0.18      | Primary Fill. Soft, loose greyish brown clayey sand.       |       |       |
| 6606   | Fill  | 6602    |           | 0.19      | Secondary Fill. Brown silt gravel.                         |       |       |
| <b>Trench 67</b>   |       |         |           |           |  |       |       |
| General description  |       |         |           |           | Orientation  |       | NW-SE |
| Trench devoid of archaeology. Consists of ploughsoil and subsoil overlying natural geology of sandy clay and gravel. |       |         |           |           | Length (m)   |       | 30    |
|  |       |         |           |           | Width (m)  |       | 2     |
|  |       |         |           |           | Avg. depth (m)   |       | 0.48  |
| Context No.  | Type  | Fill Of | Width (m) | Depth (m) | Description  | Finds | Date  |



|      |       |  |  |      |  |  |  |
|------|-------|--|--|------|--|--|--|
| 6700 | Layer |  |  | 0.32 | Ploughsoil. Dark greyish brown silty clay. |  |  |
| 6701 | Layer |  |  | 0.16 | Subsoil. Greyish brown silty clay.         |  |  |
| 6702 | Layer |  |  |      | Natural. Orange brown sandy clay.          |  |  |

### Trench 68

|  |  |  |  |                |  |       |  |
|--|--|--|--|----------------|--|-------|--|
| General description  |  |  |  | Orientation    |  | NE-SW |  |
| Trench contains one ditch. Trench consists of ploughsoil overlying sand geology. |  |  |  | Length (m)     |  | 28    |  |
|  |  |  |  | Width (m)      |  | 2.1   |  |
|  |  |  |  | Avg. depth (m) |  | 0.54  |  |

| Context No. | Type  | Fill Of | Width (m) | Depth (m) | Description   | Finds | Date     |
|-------------|-------|---------|-----------|-----------|---|-------|----------|
| 6800        | Layer |         | 2.1       | 0.3       | Ploughsoil  |       |          |
| 6801        | Layer |         | 2.1       | 0.14      | Natural. Yellowish brown silty clay with occasional sub-angular stones. |       |          |
| 6802        | Cut   |         | 1.28      | 0.32      | Ditch   |       |          |
| 6803        | Fill  | 6802    | 1.28      | 0.32      | Deliberate Backfill   |       |          |
| 6804        | Fill  | 6802    | 0.62      | 0.18      | Deliberate Backfill   | Fe    | PMed/Mod |

### Trench 69

|  |  |  |  |                |  |     |  |
|--|--|--|--|----------------|--|-----|--|
| General description  |  |  |  | Orientation    |  | E-W |  |
| Trench contains a pit. Trench consists of ploughsoil and subsoil overlying clay geology. |  |  |  | Length (m)     |  | 30  |  |
|  |  |  |  | Width (m)      |  | 2   |  |
|  |  |  |  | Avg. depth (m) |  | 0.5 |  |

| Context No. | Type  | Fill Of | Width (m) | Depth (m) | Description  | Finds | Date     |
|-------------|-------|---------|-----------|-----------|--|-------|----------|
| 6900        | Layer |         |           | 0.3       | Ploughsoil. Dark greyish brown slightly sandy silt                                     | Flint | PH (res) |
| 6901        | Layer |         |           | 0.2       | Subsoil. Brown sandy clayey silt.  |       |          |
| 6902        | Layer |         |           |           | Natural. Strong brown clayey sandy silt. Brick earth.                                  |       |          |
| 6903        | Cut   |         | 1.85      | 0.32      | Pit  |       |          |
| 6904        | Fill  | 6903    | 1.85      | 0.32      | Primary Fill. Compact mid greyish brown clayey sand with frequent charcoal inclusions. | Flint | PH       |

### Trench 70

|                     |  |  |  |             |  |       |  |
|---------------------|--|--|--|-------------|--|-------|--|
| General description |  |  |  | Orientation |  | NE-SW |  |
|                     |  |  |  | Length (m)  |  | 30    |  |

| Trench contains one pit and four natural features. Trench consists of ploughsoil and subsoil overlying sand geology. |       |         |           |           | Width (m)  |       | 2    |
|--|-------|---------|-----------|-----------|--|-------|------|
|  |       |         |           |           | Avg. depth (m)   |       | 0.5  |
| Context No.  | Type  | Fill Of | Width (m) | Depth (m) | Description  | Finds | Date |
| 7000   | Layer |         |           | 0.33      | Ploughsoil. Greyish brown silt, few pebbles  |       |      |
| 7001   | Layer |         |           | 0.12      | Subsoil. Brown slightly sandy silt. Subsoil from brickearth                                    |       |      |
| 7002   | Layer |         |           | 0.05      | Natural. Yellow slightly clayey sand, with gravel lenses                                       |       |      |
| 7003   | Cut   |         | 0.53      | 0.12      | Natural Feature. Light greyish orange. Sandy clay. Compact. Very occasional sub angled stones. |       |      |
| 7004   | Cut   |         | 1         | 0.15      | Natural Feature. Light greyish orange. Sandy clay. Compact. Occasional small rounded stones.   |       |      |
| 7005   | Cut   |         | 1.08      | 0.3       | Pit  |       |      |
| 7006   | Fill  | 7005    | 1.08      | 0.3       | Primary Fill   |       |      |
| 7007   | Cut   |         | 1.12      | 0.19      | Natural Feature. Med orangish brown. Clay sand. Soft. Occasional rooting action.               |       |      |
| 7008   | Cut   |         | 0.45      | 0.18      | Natural Feature. Greyish brown. Sandy, silty clay. Compact. Occasional sub angled stones.      |       |      |

### Trench 71

|  |  |  |  |  |                |  |       |
|--|--|--|--|--|----------------|--|-------|
| General description  |  |  |  |  | Orientation    |  | SE-NW |
| Trench contains one ditch. Trench consists of ploughsoil overlying clay geology. |  |  |  |  | Length (m)     |  | 30    |
|  |  |  |  |  | Width (m)      |  | 2     |
|  |  |  |  |  | Avg. depth (m) |  | 0.6   |

| Context No. | Type  | Fill Of | Width (m) | Depth (m) | Description                            | Finds      | Date       |
|-------------|-------|---------|-----------|-----------|--|------------|------------|
| 7100        | Layer |         |           |           | Ploughsoil. Greyish brown sandy clay   |            |            |
| 7101        | Layer |         |           |           | Natural. Reddish brown sandy clay      |            |            |
| 7102        | Fill  |         | 2.22      | 0.42      | Secondary Fill. Grey-brown sandy silt. | Pot, flint | IA?, Roman |
| 7103        | Cut   |         | 2.22      | 0.42      | Pit                                    |            |            |

| <b>Trench 72</b>   |       |         |           |           |   |                         |                |
|--|-------|---------|-----------|-----------|---|-------------------------|----------------|
| General description  |       |         |           |           | Orientation   |                         | E-W            |
| Trench contains one linear and two pits. Trench consists of ploughsoil and subsoil overlying clay and gravel geology.    |       |         |           |           | Length (m)  |                         | 30             |
|  |       |         |           |           | Width (m)   |                         | 2              |
|  |       |         |           |           | Avg. depth (m)  |                         | 0.5            |
| Context No.  | Type  | Fill Of | Width (m) | Depth (m) | Description   | Finds                   | Date           |
| 7200   | Layer |         |           | 0.3       | Ploughsoil. Dark greyish brown silt   |                         |                |
| 7201   | Layer |         |           | 0.2       | Subsoil. Yellowish brown slightly sandy silt. Subsoil from brickearth                       |                         |                |
| 7202   | Layer |         |           |           | Natural. Light yellow slightly clayey sand with lenses of gravel. Pleistocene river terrace |                         |                |
| 7203   | Cut   |         | 0.7       | 0.12      | Pit   |                         |                |
| 7204   | Fill  | 7203    | 0.7       | 0.12      | Deliberate Backfill. Dark grey-brown silt clay.   |                         |                |
| 7205   | Cut   |         | 0.73      | 0.24      | Ditch   |                         |                |
| 7206   | Fill  | 7205    | 0.73      | 0.24      | Primary Fill. Soft mid orange-brown sandy silt with no inclusions                           | Pot, flint, animal bone | ENeo or MBA-IA |
| 7207   | Cut   |         | 1.9       | 0.42      | Pit. base not reached due to 1m LOE   |                         |                |
| 7208   | Fill  | 7207    | 0.38      | 0.3       | Primary Fill. Loose mid orange pink sandy gravel  |                         |                |
| 7209   | Fill  | 7207    | 0.42      | 0.08      | Secondary Fill. Compact, light greyish pink silty clay with small gravel inclusions         |                         |                |
| 7210   | Fill  | 7207    | 1.88      | 0.21      | Secondary Fill. Compact, grey-pink sandy silt with rare, rounded pebbles.                   |                         |                |
| 7211   | Fill  | 7207    | 1.32      | 0.22      | Secondary Fill. Moderately compact light yellow-pink silty sand.                            |                         |                |
| <b>Trench 73</b>   |       |         |           |           |   |                         |                |
| General description  |       |         |           |           | Orientation   |                         | NW-SE          |
| Trench contains three ditches and two pits. Trench consists of ploughsoil and subsoil overlying clay and gravel geology. |       |         |           |           | Length (m)  |                         | 25             |
|  |       |         |           |           | Width (m)   |                         | 2.1            |
|  |       |         |           |           | Avg. depth (m)  |                         | 0.52           |

| Context No. | Type  | Fill Of | Width (m) | Depth (m) | Description   | Finds | Date     |
|-------------|-------|---------|-----------|-----------|---|-------|----------|
| 7300        | Layer |         | 2.1       | 0.26      | Ploughsoil. Grey-brown clay silt.   |       |          |
| 7301        | Layer |         | 2.1       | 0.24      | Subsoil. Yellowish brown silty clay with occasional sub-angular stones.                           |       |          |
| 7302        | Layer |         | 2.1       | 0.02      | Natural. Orangish brown silty clay mottled with patches of light brownish yellow sand and gravel. |       |          |
| 7303        | Cut   |         | 0.76      | 0.35      | Pit   |       |          |
| 7304        | Fill  | 7303    | 0.76      | 0.35      | Deliberate Backfill. Dark grey-brown clay silt.   |       |          |
| 7305        | Cut   |         | 0.44      | 0.29      | Ditch   |       |          |
| 7306        | Fill  | 7305    | 0.44      | 0.29      | Primary Fill. Grey-brown silt clay.   |       |          |
| 7307        | Cut   |         | 2.22      | 0.25      | Ditch   |       |          |
| 7308        | Fill  | 7307    | 2.22      | 0.25      | Primary Fill. Grey-brown silt clay.   |       |          |
| 7309        | Cut   |         | 0.25      | 0.23      | Pit   |       |          |
| 7310        | Fill  | 7309    | 0.25      | 0.23      | Deliberate Backfill. Brown-grey silt clay.  |       |          |
| 7311        | Cut   |         | 0.85      | 0.29      | Ditch   |       |          |
| 7312        | Fill  | 7311    | 0.85      | 0.29      | Primary Fill. Dark grey-brown silt clay.  | Pot   | AD 1–150 |

#### Trench 74

|   |  |                |       |
|---|--|----------------|-------|
| General description   |  | Orientation    | SE-NW |
| Trench contains a single pit. Trench consists of ploughsoil and subsoil overlying clay geology. |  | Length (m)     | 30    |
|   |  | Width (m)      | 2     |
|   |  | Avg. depth (m) | 0.45  |

| Context No. | Type  | Fill Of | Width (m) | Depth (m) | Description                                     | Finds | Date |
|-------------|-------|---------|-----------|-----------|---|-------|------|
| 7400        | Layer |         |           | 0.3       | Ploughsoil. Greyish brown slightly sandy silt   |       |      |
| 7401        | Layer |         |           | 0.1       | Subsoil. Brown slightly sandy silt              |       |      |
| 7402        | Layer |         |           |           | Natural. Orangish brown, silty clay, firm       |       |      |
| 7403        | Cut   |         | 1         | 0.16      | Pit   |       |      |
| 7404        | Fill  | 7403    | 1         | 0.16      | Deliberate Backfill. Dark grey-brown silt clay. |       |      |

#### Trench 75

| General description  |       |         |           |           | Orientation  |       | SE-NW |
|--|-------|---------|-----------|-----------|--|-------|-------|
| Trench contains two pits. Trench consists of ploughsoil and subsoil overlying sand and clay geology. |       |         |           |           | Length (m)   |       | 30    |
|  |       |         |           |           | Width (m)  |       | 2     |
|  |       |         |           |           | Avg. depth (m)   |       | 0.55  |
| Context No.  | Type  | Fill Of | Width (m) | Depth (m) | Description  | Finds | Date  |
| 7500   | Layer |         |           | 0.35      | Ploughsoil. Dark brownish grey slightly sandy silt.  |       |       |
| 7501   | Layer |         |           | 0.2       | Subsoil. Brown slightly sandy silt. Subsoil from brickearth  |       |       |
| 7502   | Layer |         |           |           | Natural. Strong brown clayey silty sand with lenses of gravel. Interface of brick earth to gravelly sand |       |       |
| 7503   | Cut   |         | 1.1       | 0.21      | Pit  |       |       |
| 7504   | Fill  | 7503    | 1.1       | 0.21      | Primary Fill. Soft greyish brown clayey sand.  |       |       |
| 7505   | Cut   |         | 1.48      | 0.32      | Pit. Edge of pit disappears into NW bulk.  |       |       |
| 7506   | Fill  | 7505    | 1.48      | 0.32      | Primary Fill. Compact light reddish brown sandy clay   | Flint | PH    |

### Trench 76

| General description  |       |         |           |           | Orientation  |            | NE-SW                          |
|--|-------|---------|-----------|-----------|--|------------|--------------------------------|
| Trench contains a posthole, a pit, two ditches and a natural feature. Trench consists of ploughsoil and subsoil overlying sand and clay geology. |       |         |           |           | Length (m)   |            | 30                             |
|  |       |         |           |           | Width (m)  |            | 2                              |
|  |       |         |           |           | Avg. depth (m)   |            | 0.6                            |
| Context No.  | Type  | Fill Of | Width (m) | Depth (m) | Description  | Finds      | Date                           |
| 7600   | Layer |         |           | 0.3       | Ploughsoil. Dark grey-brown sandy silt                           |            |                                |
| 7601   | Layer |         |           | 0.2       | Subsoil. Reddish brown, clay sandy silt                          |            |                                |
| 7602   | Layer |         |           |           | Natural. Mixed silty clay and gravels.                           |            |                                |
| 7603   | Cut   |         | 2.24      |           | Pit. Not bottomed  |            |                                |
| 7604   | Fill  | 7603    | 0.94      | 0.3       | Deliberate Backfill. Friable dark grey silty sand. <S25>         | Pot, flint | AD 400 – 750, AD 170–230 (res) |
| 7605   | Fill  | 7603    | 1.4       | 0.28      | Primary Fill. Moderately friable light greyish yellow silty sand | Pot, flint | Roman, PH (res)                |

|      |      |      |      |      |   |          |       |
|------|------|------|------|------|---|----------|-------|
| 7606 | Fill | 7615 | 1.9  | 0.24 | Primary Fill. Friable mid greyish yellow silty sand | Pot, CBM | Roman |
| 7607 | Cut  |      |      |      | Natural Feature. Brownish red silty clay, compact   |          |       |
| 7608 | Cut  |      | 0.44 | 0.12 | Ditch. Gully  |          |       |
| 7609 | Fill | 7608 | 0.44 | 0.12 | Primary Fill. Friable greyish brown silty sand      |          |       |
| 7610 | Cut  |      | 0.34 | 0.14 | Ditch. Gully  |          |       |
| 7611 | Fill |      | 0.34 | 0.14 | Primary Fill. Friable greyish brown silty sand      |          |       |
| 7612 | Cut  |      | 0.26 | 0.1  | Posthole. Possible posthole                         |          |       |
| 7613 | Fill | 7612 | 0.26 | 0.1  | Primary Fill. Friable greyish brown silty sand      |          |       |
| 7614 | Cut  |      | 0.94 | 0.3  | Pit. Double number of 7603. It is the same feature. |          |       |
| 7615 | Cut  |      | 1.3  | 0.24 | Pit   |          |       |

#### Trench 77

| General description   |       |         |           |           | Orientation  |       | NE-SW  |
|---|-------|---------|-----------|-----------|--|-------|--------|
| Trench consists of ploughsoil with subsoil overlying sand clay geology. |       |         |           |           | Length (m)   |       | 30     |
|   |       |         |           |           | Width (m)  |       | 2      |
|   |       |         |           |           | Avg. depth (m)   |       | 0.5    |
| Context No.   | Type  | Fill Of | Width (m) | Depth (m) | Description  | Finds | Date   |
| 7700  | Layer |         |           | 0.3       | Ploughsoil. Brown clay silt.   |       |        |
| 7701  | Layer |         |           | 0.15      | Subsoil. Brown silt sand.  |       |        |
| 7702  | Layer |         |           |           | Natural. Light red-brown silt clay.                                      |       |        |
| 7703  | Cut   |         | 1.19      | 0.07      | Natural Feature. Natural pit. Sub ovular. Dark reddish brown clayey silt |       |        |
| 7704  | Layer |         | 3.08      |           | Natural. Sub circular pit. Light reddish brown clayey silt.              | Pot   | MBA-IA |

#### Trench 78

| General description  |      |         |           |           | Orientation    |       | N-S  |
|--|------|---------|-----------|-----------|----------------|-------|------|
| Trench consists of two ditches and a pit. Trench consists of ploughsoil overlying clay and gravel geology. |      |         |           |           | Length (m)     |       | 30   |
|  |      |         |           |           | Width (m)      |       | 2.1  |
|  |      |         |           |           | Avg. depth (m) |       | 0.4  |
| Context No.  | Type | Fill Of | Width (m) | Depth (m) | Description    | Finds | Date |

|      |       |      |      |      |  |     |       |
|------|-------|------|------|------|--|-----|-------|
| 7800 | Layer |      |      | 0.3  | Ploughsoil. Dark grey-brown clay silt.   |     |       |
| 7801 | Layer |      |      | 0.1  | Natural. Brownish orange silty clay with occasional patches of gravel.   |     |       |
| 7802 | Cut   |      | 1.9  | 0.45 | Ditch  |     |       |
| 7803 | Fill  |      | 1.4  | 0.45 | Primary Fill. Grey-brown clay silt.  | Pot | Roman |
| 7804 | Cut   |      | 0.8  | 0.35 | Pit  |     |       |
| 7805 | Fill  | 7804 | 0.8  | 0.35 | Primary Fill. Firm, dark greyish brown silty clay  |     |       |
| 7806 | Cut   |      | 0.3  | 0.12 | Ditch  |     |       |
| 7807 | Fill  | 7806 | 0.3  | 0.12 | Primary Fill. Soft, greyish brown silty clay   |     |       |
| 7808 | Fill  | 7802 | 0.7  | 0.3  | Primary Fill. Firm, light yellowish grey silty clay  |     |       |
| 7809 | Fill  | 7802 | 0.55 | 0.45 | Primary Fill. Firm, orange-brown silty clay  |     |       |
| 7810 | Fill  | 7804 | 0.45 | 0.3  | Primary Fill. Firm, orange-brown silty clay  |     |       |
| 7811 | Cut   |      | 1.8  | 0.45 | Natural Feature. Possible Natural Hollow running E-W through trench - fill consists of a soft, light greyish brown silty clay with gravel inclusion. |     |       |

### Trench 79

| General description  |       |         |           |           | Orientation                             |       | E-W  |
|--|-------|---------|-----------|-----------|---|-------|------|
| Trench devoid of archaeology. Consists of ploughsoil overlaying natural. |       |         |           |           | Length (m)                              |       | 30   |
|  |       |         |           |           | Width (m)                               |       | 2.1  |
|  |       |         |           |           | Avg. depth (m)                          |       | 0.3  |
| Context No.  | Type  | Fill Of | Width (m) | Depth (m) | Description                             | Finds | Date |
| 7900   | Layer |         | 2.1       | 0.34      | Ploughsoil. Dark grey-brown sandy silt. |       |      |
| 7901   | Layer |         | 2.1       | 0.14      | Natural. Mixed gravels                  |       |      |

### Trench 80

|   |  |  |  |  |                |  |       |
|---|--|--|--|--|----------------|--|-------|
| General description   |  |  |  |  | Orientation    |  | SE-NW |
| Trench devoid of archaeology. Trench consists of ploughsoil and subsoil overlying clay geology. |  |  |  |  | Length (m)     |  | 30    |
|   |  |  |  |  | Width (m)      |  | 2     |
|   |  |  |  |  | Avg. depth (m) |  | 0.5   |

| Context No.  | Type  | Fill Of | Width (m) | Depth (m) | Description  | Finds | Date  |
|--|-------|---------|-----------|-----------|--|-------|-------|
| 8000   | Layer |         |           | 0.3       | Ploughsoil. Brown clay silt.   |       |       |
| 8001   | Layer |         |           | 0.1       | Subsoil. Red-brown clay silt.  |       |       |
| 8002   | Layer |         |           |           | Natural. Light brown-red silt clay.                                    |       |       |
| <b>Trench 81</b>   |       |         |           |           |  |       |       |
| General description  |       |         |           |           | Orientation  |       | NE-SW |
| Probable tree-throw at centre. Plough soil overlaying natural.                                   |       |         |           |           | Length (m)   |       | 30    |
|  |       |         |           |           | Width (m)  |       | 2.1   |
|  |       |         |           |           | Avg. depth (m)   |       | 0.48  |
| Context No.  | Type  | Fill Of | Width (m) | Depth (m) | Description  | Finds | Date  |
| 8100   | Layer |         | 2.1       | 0.35      | Ploughsoil. Dark grey-brown sandy silt                                 |       |       |
| 8101   | Layer |         | 2.1       | 0.18      | Natural. Orangish brown silty clay with occasional sub-angular stones. |       |       |
| <b>Trench 82</b>   |       |         |           |           |  |       |       |
| General description  |       |         |           |           | Orientation  |       | E-W   |
| Trench contains a single posthole. Trench consists of ploughsoil over clay sand geology.         |       |         |           |           | Length (m)   |       | 30    |
|  |       |         |           |           | Width (m)  |       | 2     |
|  |       |         |           |           | Avg. depth (m)   |       | 0.5   |
| Context No.  | Type  | Fill Of | Width (m) | Depth (m) | Description  | Finds | Date  |
| 8200   | Layer |         |           | 0.45      | Ploughsoil. Brown clay silt  |       |       |
| 8201   | Layer |         |           |           | Natural. Red-brown clayey sand   |       |       |
| 8202   | Cut   |         | 0.58      | 0.38      | Posthole   |       |       |
| 8203   | Fill  | 8206    | 0.22      | 0.14      | Deliberate Backfill. Greenish grey silty clay                          |       |       |
| 8204   | Fill  | 8202    | 0.32      | 0.38      | Primary Fill. Dark brownish grey sandy clay                            |       |       |
| 8205   | Fill  | 8202    | 0.2       | 0.33      | Secondary Fill. Brownish grey sandy clay                               |       |       |
| 8206   | Cut   |         | 0.22      | 0.14      | Posthole   |       |       |
| <b>Trench 83</b>   |       |         |           |           |  |       |       |
| General description  |       |         |           |           | Orientation  |       | N-S   |
| Trench contains two ditches and a pit. Trench consists of ploughsoil over clay and sand geology. |       |         |           |           | Length (m)   |       | 25    |
|  |       |         |           |           | Width (m)  |       | 2     |
|  |       |         |           |           | Avg. depth (m)   |       | 0.47  |



| Context No. | Type  | Fill Of | Width (m) | Depth (m) | Description   | Finds | Date  |
|-------------|-------|---------|-----------|-----------|---|-------|-------|
| 8300        | Layer |         |           | 0.4       | Ploughsoil. Brown clay silt                                 |       |       |
| 8301        | Layer |         |           |           | Natural. Red-brown clay sand                                |       |       |
| 8302        | Cut   |         | 2.1       | 0.3       | Ditch   |       |       |
| 8303        | Fill  | 8302    | 1.9       | 0.18      | Primary Fill. Moderately compact orange grey silty clay     |       |       |
| 8304        | Fill  | 8302    | 1.5       | 0.2       | Secondary Fill. Moderately compact greyish brown silty clay | Pot   | Roman |
| 8305        | Cut   |         | 0.7       | 0.2       | Ditch   |       |       |
| 8306        | Fill  | 8305    | 0.7       | 0.2       | Primary Fill. Moderately compact orange grey silty clay     | Pot   | UD    |
| 8307        | Cut   |         | 3.4       | 0.42      | Pit. Possible pit   |       |       |
| 8308        | Fill  | 8307    | 3.4       | 0.42      | Primary Fill. Moderately compact greyish brown silty clay   |       |       |

#### Trench 84

|  |                |     |
|--|----------------|-----|
| General description  | Orientation    | E-W |
| Trench contains a ditch and a natural feature. Trench consists of ploughsoil overlying clay geology. | Length (m)     | 30  |
|  | Width (m)      | 2   |
|  | Avg. depth (m) | 0.4 |

| Context No. | Type  | Fill Of | Width (m) | Depth (m) | Description  | Finds | Date |
|-------------|-------|---------|-----------|-----------|--|-------|------|
| 8400        | Layer |         |           | 0.35      | Ploughsoil. Brown clay silt.   |       |      |
| 8401        | Layer |         |           |           | Natural. Yellowish brown sand silt.  |       |      |
| 8402        | Cut   |         | 1.92      | 0.52      | Natural Feature. Sub-circular cut with moderately sloping concave sides and base. Both sides and base have irregularities. |       |      |
| 8403        | Fill  | 8402    | 1.92      | 0.52      | Primary Fill. Moderately compact mid greyish brown silty clay with occasional sub-angular stones. Bioturbation throughout. |       |      |
| 8404        | Cut   |         |           | 0.07      | Ditch  |       |      |
| 8405        | Fill  | 8404    |           | 0.07      | Primary Fill. Dark orangish grey, silty  |       |      |

|      |      |      |      |      |   |  |  |
|------|------|------|------|------|---|--|--|
|      |      |      |      |      | clay, occasional small subangular stones  |  |  |
| 8406 | Cut  |      | 2.38 | 0.7  | Ditch. Linear ditch running NW-SE with moderately sloping convex sides and a concave base.  |  |  |
| 8407 | Fill | 8406 | 2.38 | 0.6  | Deliberate Backfill. Moderately compact mid greyish brown silty clay with occasional sub-angular stones, charcoal and CBM flecks.   |  |  |
| 8408 | Fill | 8406 | 1.08 | 0.08 | Deliberate Backfill. Moderately compact mottled mid greyish brown silty clay with mid brownish orange silty sand with occasional sub-angular stones, charcoal and CBM flecks. |  |  |

### Trench 85

| General description  |       |         |           |           | Orientation                              |       | N-S  |
|--|-------|---------|-----------|-----------|--|-------|------|
| Trench contains a ditch and a pit. Trench consists of ploughsoil over clay sand natural. |       |         |           |           | Length (m)                               |       | 25   |
|  |       |         |           |           | Width (m)                                |       | 2    |
|  |       |         |           |           | Avg. depth (m)                           |       | 0.49 |
| Context No.  | Type  | Fill Of | Width (m) | Depth (m) | Description                              | Finds | Date |
| 8500   | Layer |         |           | 0.45      | Ploughsoil. Brown clay silt              |       |      |
| 8501   | Layer |         |           |           | Natural. Red-brown clay sand             |       |      |
| 8502   | Cut   |         | 0.57      | 0.16      | Ditch                                    |       |      |
| 8503   | Fill  | 8502    | 0.57      | 0.16      | Primary Fill. Dark grey-brown silt clay. |       |      |
| 8504   | Cut   |         | 0.79      | 0.16      | Pit                                      |       |      |
| 8505   | Fill  | 8504    | 0.79      | 0.16      | Primary Fill. Grey-brown silt clay.      |       |      |

### Trench 86

| General description  |      |         |           |           | Orientation    |       | E-W  |
|--|------|---------|-----------|-----------|----------------|-------|------|
| Trench contains a ditch. Trench consists of ploughsoil over clay sand natural. |      |         |           |           | Length (m)     |       | 30   |
|  |      |         |           |           | Width (m)      |       | 2    |
|  |      |         |           |           | Avg. depth (m) |       | 0.48 |
| Context No.  | Type | Fill Of | Width (m) | Depth (m) | Description    | Finds | Date |

|      |       |      |      |      |                                     |  |  |
|------|-------|------|------|------|-------------------------------------|--|--|
| 8600 | Layer |      |      | 0.48 | Ploughsoil. Brown clay silt.        |  |  |
| 8601 | Layer |      |      |      | Natural. Red-brown clay sand        |  |  |
| 8602 | Cut   |      | 0.53 | 0.15 | Ditch                               |  |  |
| 8603 | Fill  | 8602 | 0.53 | 0.15 | Primary Fill. Grey-brown silt clay. |  |  |

### Trench 87

| General description   |       |         |           |           | Orientation  | N-S   |      |
|---|-------|---------|-----------|-----------|--|-------|------|
| Trench contains two natural features. Trench consists of ploughsoil over clay sand geology. |       |         |           |           | Length (m)   | 30    |      |
|   |       |         |           |           | Width (m)  | 2     |      |
|   |       |         |           |           | Avg. depth (m)   | 0.49  |      |
| Context No.   | Type  | Fill Of | Width (m) | Depth (m) | Description  | Finds | Date |
| 8700  | Layer |         |           | 0.5       | Ploughsoil. Brown clay silt                                |       |      |
| 8701  | Layer |         |           |           | Natural. Red-brown clay sand                               |       |      |
| 8702  | Cut   |         |           |           | Natural Feature. Orange-brown silty clay.                  |       |      |
| 8703  | Cut   |         |           |           | Natural Feature. Tree-throw hole. Reddish grey silty clay. | Flint | PH   |

### Trench 88

| General description  |       |         |           |           | Orientation                           | E-W        |          |
|--|-------|---------|-----------|-----------|---------------------------------------|------------|----------|
| Trench contains a pit. Trench consists of ploughsoil over clay sand natural. |       |         |           |           | Length (m)                            | 30         |          |
|  |       |         |           |           | Width (m)                             | 2          |          |
|  |       |         |           |           | Avg. depth (m)                        | 0.49       |          |
| Context No.  | Type  | Fill Of | Width (m) | Depth (m) | Description                           | Finds      | Date     |
| 8800   | Layer |         |           | 0.44      | Ploughsoil. Brown clay silt           | Flint      | PH (res) |
| 8801   | Layer |         |           |           | Natural. Red-brown clay sand          |            |          |
| 8802   | Cut   |         | 1.14      | 0.45      | Pit                                   |            |          |
| 8803   | Fill  | 8802    |           | 0.26      | Secondary Fill. Grey-brown clay silt. | Pot, flint | ENeo     |
| 8804   | Fill  | 8802    |           | 0.43      | Secondary Fill. Brown-grey clay silt. | Pot, flint | ENeo     |

### Trench 89

| General description  |      |         |           |           | Orientation    | NE-SW |      |
|--|------|---------|-----------|-----------|----------------|-------|------|
| Trench contains one ditch. Trench consists of ploughsoil overlying clay geology. |      |         |           |           | Length (m)     | 30    |      |
|  |      |         |           |           | Width (m)      | 2.1   |      |
|  |      |         |           |           | Avg. depth (m) | 0.53  |      |
| Context No.  | Type | Fill Of | Width (m) | Depth (m) | Description    | Finds | Date |

|      |       |      |     |      |  |                 |                             |
|------|-------|------|-----|------|--|-----------------|-----------------------------|
| 8900 | Layer |      | 2.1 | 0.3  | Ploughsoil   |                 |                             |
| 8901 | Layer |      | 2.1 | 0.12 | Natural. Orangish brown silty clay with occasional sub-angular stones. |                 |                             |
| 8902 | Cut   |      |     |      | Ditch  |                 |                             |
| 8903 | Fill  | 8902 |     |      | Primary Fill. Brownish grey sandy clay                                 | Pot, CBM, stone | AD 1000 – 1225, Roman (res) |

### Trench 90

| General description   |       |         |           |           | Orientation   |       | NW-SE |
|---|-------|---------|-----------|-----------|---|-------|-------|
| Trench contains one ditch. Trench consists of ploughsoil overlaying clay geology. |       |         |           |           | Length (m)  |       | 30    |
|   |       |         |           |           | Width (m)   |       | 2.1   |
|   |       |         |           |           | Avg. depth (m)  |       | 0.47  |
| Context No.   | Type  | Fill Of | Width (m) | Depth (m) | Description   | Finds | Date  |
| 9000  | Layer |         | 2.1       | 0.3       | Topsoil. Plough soil  |       |       |
| 9001  | Layer |         | 2.1       | 0.2       | Natural. Reddish brown silty clay with occasional sub-angular stones. |       |       |
| 9002  | Cut   |         | 1.44      | 0.13      | Ditch   |       |       |
| 9003  | Fill  | 9002    | 1.44      | 0.13      | Primary Fill. Dark grey-brown silty clay                              |       |       |

### Trench 91

| General description   |       |         |           |           | Orientation                  |       | E-W  |
|---|-------|---------|-----------|-----------|------------------------------|-------|------|
| Trench devoid of archaeology. Trench consists of ploughsoil over clay sand natural. |       |         |           |           | Length (m)                   |       | 30   |
|   |       |         |           |           | Width (m)                    |       | 2    |
|   |       |         |           |           | Avg. depth (m)               |       | 0.35 |
| Context No.   | Type  | Fill Of | Width (m) | Depth (m) | Description                  | Finds | Date |
| 9100  | Layer |         |           | 0.35      | Ploughsoil. Brown clay silt  |       |      |
| 9101  | Layer |         |           |           | Natural. Red-brown clay sand |       |      |

### Trench 92

| General description   |       |         |           |           | Orientation                  |       | N-S  |
|---|-------|---------|-----------|-----------|------------------------------|-------|------|
| Trench contains a ditch and a tree-throw. Trench consists of ploughsoil over clay sand geology. |       |         |           |           | Length (m)                   |       | 30   |
|   |       |         |           |           | Width (m)                    |       | 2    |
|   |       |         |           |           | Avg. depth (m)               |       | 0.35 |
| Context No.   | Type  | Fill Of | Width (m) | Depth (m) | Description                  | Finds | Date |
| 9200  | Layer |         |           | 0.35      | Ploughsoil. Brown clay silt  |       |      |
| 9201  | Layer |         |           |           | Natural. Red-brown clay sand |       |      |

|      |                     |      |      |      |   |  |  |
|------|---------------------|------|------|------|---|--|--|
| 9202 | Cut                 |      | 0.73 | 0.22 | Ditch                                   |  |  |
| 9203 | Fill                | 9202 | 0.73 | 0.22 | Primary Fill. Grey-brown clay silt.     |  |  |
| 9204 | Layer               |      | 0.25 | 0.1  | Other Layer. Dark grey-brown silt.      |  |  |
| 9205 | Unexcavated feature |      | 3.5  |      | Tree Throw. Light grey-brown clay silt. |  |  |

### Trench 93

|   |  |  |  |  |                |  |     |
|---|--|--|--|--|----------------|--|-----|
| General description   |  |  |  |  | Orientation    |  | E-W |
| Trench contains two pits and a ditch. Trench consists of ploughsoil overlying clay geology. |  |  |  |  | Length (m)     |  | 30  |
|   |  |  |  |  | Width (m)      |  | 2   |
|   |  |  |  |  | Avg. depth (m) |  | 0.4 |

| Context No. | Type  | Fill Of | Width (m) | Depth (m) | Description   | Finds      | Date   |
|-------------|-------|---------|-----------|-----------|---|------------|--------|
| 9300        | Layer |         |           | 0.35      | Ploughsoil. Brown clay silt.  |            |        |
| 9301        | Layer |         |           |           | Natural. Yellowish brown sand clay.   |            |        |
| 9302        | Cut   |         | 0.65      | 0.36      | Pit   |            |        |
| 9303        | Fill  | 9302    | 0.65      | 0.36      | Secondary Fill. Red-brown silt sand.  | Pot, flint | MBA-IA |
| 9304        | Cut   |         | 1         | 0.46      | Pit   |            |        |
| 9305        | Fill  | 9304    | 1         | 0.46      | Secondary Fill. Greyish brown Silty clay Firm                                 |            |        |
| 9306        | Fill  | 9304    |           |           | Secondary Fill. Not shown on section. Yellowish brown Very compact Sandy clay |            |        |
| 9307        | Cut   |         | 1.85      | 0.6       | Ditch   |            |        |
| 9308        | Fill  | 9307    | 1.85      | 0.6       | Secondary Fill. Greyish brown Silty clay Very compact                         | Pot        | Roman  |

### Trench 94

|  |  |  |  |  |                |  |     |
|--|--|--|--|--|----------------|--|-----|
| General description  |  |  |  |  | Orientation    |  | N-S |
| Trench devoid of archaeology. Consists of ploughsoil overlying clay geology. |  |  |  |  | Length (m)     |  | 30  |
|  |  |  |  |  | Width (m)      |  | 2   |
|  |  |  |  |  | Avg. depth (m) |  | 0.4 |

| Context No. | Type  | Fill Of | Width (m) | Depth (m) | Description                   | Finds | Date |
|-------------|-------|---------|-----------|-----------|-------------------------------|-------|------|
| 9400        | Layer |         |           | 0.35      | Ploughsoil. Brown clay silt.  |       |      |
| 9401        | Layer |         |           |           | Natural. Red-brown clay sand. |       |      |

### Trench 95

|                     |  |  |  |  |             |  |     |
|---------------------|--|--|--|--|-------------|--|-----|
| General description |  |  |  |  | Orientation |  | E-W |
|                     |  |  |  |  | Length (m)  |  | 30  |

| Trench contains a ditch. Trench consists of ploughsoil overlying clay geology. |       |         |           |           | Width (m)                                | 2     |      |
|--|-------|---------|-----------|-----------|--|-------|------|
|  |       |         |           |           | Avg. depth (m)                           | 0.4   |      |
| Context No.  | Type  | Fill Of | Width (m) | Depth (m) | Description                              | Finds | Date |
| 9500   | Layer |         |           | 0.35      | Ploughsoil. Brown clay silt.             |       |      |
| 9501   | Layer |         |           |           | Natural. Red-brown silt clay.            |       |      |
| 9502   | Cut   |         | 1.75      | 0.32      | Ditch                                    |       |      |
| 9503   | Fill  | 9502    | 1.75      | 0.32      | Primary Fill. Dark grey-brown silt clay. |       |      |

### Trench 96

| General description   |       |         |           |           | Orientation   | N-S        |                |
|---|-------|---------|-----------|-----------|---|------------|----------------|
| Trench contains two natural features, a tree-throw, a pit and a ditch. Trench consists of ploughsoil and subsoil overlying clay and sand geology. |       |         |           |           | Length (m)  | 30         |                |
|   |       |         |           |           | Width (m)   | 2          |                |
|   |       |         |           |           | Avg. depth (m)  | 0.7        |                |
| Context No.   | Type  | Fill Of | Width (m) | Depth (m) | Description   | Finds      | Date           |
| 9600  | Layer |         |           | 0.3       | Ploughsoil. Brown clay silt.  | Flint      | PH (res)       |
| 9601  | Layer |         |           | 0.35      | Subsoil. Light brown clay sand.   |            |                |
| 9602  | Layer |         |           |           | Natural. Light yellowish brown clay sand gravel.                                    |            |                |
| 9603  | Cut   |         | 0.68      | 0.18      | Pit   |            |                |
| 9604  | Fill  | 9603    | 0.68      | 0.18      | Tertiary Fill. Brown yellow silty sand.   |            |                |
| 9605  | Cut   |         | 0.86      | 0.24      | Natural Feature   |            |                |
| 9606  | Layer |         |           |           | Natural   |            |                |
| 9607  | Cut   |         | 1.1       | 0.64      | Ditch   |            |                |
| 9608  | Fill  | 9607    | 1.1       | 0.64      | Secondary Fill. Backfill containing small amounts of burning remains, pot and flint | Pot, flint | LBA/IA?        |
| 9609  | Cut   |         | 1.5       | 0.41      | Tree Throw. Tree throw containing small amount of pot                               |            |                |
| 9610  | Fill  | 9609    | 0.62      | 0.23      | Secondary Fill. Initial silting. Compact white brown sandy silt                     | Pot        | ENeo or MBA-IA |
| 9611  | Fill  | 9609    | 1.5       | 0.39      | Tertiary Fill. Final silting phase. Mid brown clayey silt.                          |            |                |
| 9612  | Cut   | 9612    |           |           | Natural Feature   |            |                |

### Trench 97

|                     |  |  |  |  |             |     |  |
|---------------------|--|--|--|--|-------------|-----|--|
| General description |  |  |  |  | Orientation | N-S |  |
|                     |  |  |  |  | Length (m)  | 30  |  |

| Trench devoid of archaeology. Trench consists of ploughsoil overlying clay geology.                     |       |         |           |           | Width (m)  | 2          |        |
|---|-------|---------|-----------|-----------|--|------------|--------|
|   |       |         |           |           | Avg. depth (m)                                   | 0.5        |        |
| Context No.   | Type  | Fill Of | Width (m) | Depth (m) | Description                                      | Finds      | Date   |
| 9700  | Layer |         |           | 0.45      | Ploughsoil. Brown clay silt.                     |            |        |
| 9701  | Layer |         |           |           | Natural. Red-brown silt clay.                    |            |        |
| <b>Trench 98</b>  |       |         |           |           |  |            |        |
| General description   |       |         |           |           | Orientation                                      | SE-NW      |        |
| Trench contains one ditch terminus and two pits. Trench consists of ploughsoil overlying clay geology.  |       |         |           |           | Length (m)                                       | 30         |        |
|   |       |         |           |           | Width (m)  | 2          |        |
|   |       |         |           |           | Avg. depth (m)                                   | 0.5        |        |
| Context No.   | Type  | Fill Of | Width (m) | Depth (m) | Description                                      | Finds      | Date   |
| 9800  | Layer |         |           | 0.45      | Ploughsoil. Brown clay silt.                     |            |        |
| 9801  | Layer |         |           |           | Natural. Light yellowish brown sand clay.        |            |        |
| 9802  | Cut   |         | 0.88      | 0.24      | Ditch  |            |        |
| 9803  | Fill  | 9802    | 0.88      | 0.24      | Primary Fill. Orange-brown sand clay.            | Flint      | PH     |
| 9804  | Cut   |         | 1         | 0.42      | Pit  |            |        |
| 9805  | Fill  | 9804    | 1         | 0.42      | Primary Fill. Soft, greyish brown, sandy clay.   | Pot, flint | MBA-IA |
| 9806  | Cut   |         | 1.02      | 0.3       | Pit  |            |        |
| 9807  | Fill  | 9806    | 1.02      | 0.3       | Primary Fill. Soft, greyish brown, sandy clay.   |            |        |
| <b>Trench 99</b>  |       |         |           |           |  |            |        |
| General description   |       |         |           |           | Orientation                                      | N-S        |        |
| Trench contains a posthole and a natural feature. Trench consists of ploughsoil over clay sand natural. |       |         |           |           | Length (m)                                       | 30         |        |
|   |       |         |           |           | Width (m)  | 2          |        |
|   |       |         |           |           | Avg. depth (m)                                   | 0.5        |        |
| Context No.   | Type  | Fill Of | Width (m) | Depth (m) | Description                                      | Finds      | Date   |
| 9900  | Layer |         |           | 0.45      | Ploughsoil. Brown clay silt                      |            |        |
| 9901  | Layer |         |           |           | Natural. Mid red-brown clay sand                 |            |        |
| 9902  | Cut   |         | 0.19      | 0.11      | Posthole   |            |        |
| 9903  | Fill  | 9902    | 0.19      | 0.11      | Primary Fill. Grey-brown sand clay.              |            |        |
| 9904  | Cut   |         | 0.5       | 0.12      | Natural Feature. Tree throw. Greyish brown fill. |            |        |
| <b>Trench 100</b>   |       |         |           |           |  |            |        |

| General description  |       |         |           |           |   | Orientation    |        | E-W  |
|--|-------|---------|-----------|-----------|---|----------------|--------|------|
| Trench contains one ditch and one natural feature. Trench consists of ploughsoil overlying clay geology. |       |         |           |           |   | Length (m)     |        | 30   |
|  |       |         |           |           |   | Width (m)      |        | 2    |
|  |       |         |           |           |   | Avg. depth (m) |        | 0.45 |
| Context No.  | Type  | Fill Of | Width (m) | Depth (m) | Description                                     | Finds          | Date   |      |
| 10000  | Layer |         |           | 0.4       | Ploughsoil. Brown clay silt.                    |                |        |      |
| 10001  | Layer |         |           |           | Natural. Red-brown silt clay.                   |                |        |      |
| 10002  | Cut   |         | 0.98      |           | Natural Feature                                 |                |        |      |
| 10003  | Cut   |         | 0.77      | 0.3       | Ditch. Possibly prehistoric ditch running SE-NW |                |        |      |
| 10004  | Fill  | 10003   | 0.77      | 0.3       | Secondary Fill. Blackish brown sandy silt       | Pot, flint     | MBA-IA |      |

### Trench 101

| General description   |       |         |           |           |                                     | Orientation    |      | N-S |
|---|-------|---------|-----------|-----------|-------------------------------------|----------------|------|-----|
| Trench devoid of archaeology. Trench consists of ploughsoil overlying clay geology. |       |         |           |           |                                     | Length (m)     |      | 30  |
|   |       |         |           |           |                                     | Width (m)      |      | 2   |
|   |       |         |           |           |                                     | Avg. depth (m) |      | 0.4 |
| Context No.   | Type  | Fill Of | Width (m) | Depth (m) | Description                         | Finds          | Date |     |
| 10100   | Layer |         |           | 0.35      | Ploughsoil. Brown clay silt.        |                |      |     |
| 10101   | Layer |         |           |           | Natural. Yellowish brown sand silt. |                |      |     |

### Trench 102

| General description  |       |         |           |           |   | Orientation    |      | E-W |
|--|-------|---------|-----------|-----------|---|----------------|------|-----|
| Trench contains one pit. Trench consists of ploughsoil overlying clay geology. |       |         |           |           |   | Length (m)     |      | 30  |
|  |       |         |           |           |   | Width (m)      |      | 2   |
|  |       |         |           |           |   | Avg. depth (m) |      | 0.4 |
| Context No.  | Type  | Fill Of | Width (m) | Depth (m) | Description   | Finds          | Date |     |
| 10200  | Layer |         |           | 0.35      | Ploughsoil. Brown clay silt.  |                |      |     |
| 10201  | Layer |         |           |           | Natural. Yellowish brown silt clay.   |                |      |     |
| 10202  | Cut   |         | 0.72      |           | Natural Feature   |                |      |     |
| 10203  | Cut   |         | 0.9       | 0.18      | Pit. Fire pit   |                |      |     |
| 10204  | Fill  | 10203   |           | 0.1       | Primary Fill. Moderately compact mid yellowish grey silty clay                  |                |      |     |
| 10205  | Fill  | 10203   |           | 0.14      | Secondary Fill. Scorched. Moderately compact mixed orange red silty clay. <S22> | Pot            | IA?  |     |



| <b>Trench 103</b>   |       |         |           |           |   |                         |                |
|---|-------|---------|-----------|-----------|---|-------------------------|----------------|
| General description   |       |         |           |           | Orientation   |                         | N-S            |
| Trench contains a ditch, a pit and a natural feature. Trench consists of ploughsoil overlying clay geology. |       |         |           |           | Length (m)  |                         | 30             |
|   |       |         |           |           | Width (m)   |                         | 2              |
|   |       |         |           |           | Avg. depth (m)  |                         | 0.4            |
| Context No.   | Type  | Fill Of | Width (m) | Depth (m) | Description   | Finds                   | Date           |
| 10300   | Layer |         |           | 0.35      | Ploughsoil. Brown clay silt.                              |                         |                |
| 10301   | Layer |         |           |           | Natural. Red-brown silt sand clay.                        |                         |                |
| 10302   | Cut   |         | 1.3       | 0.22      | Pit   |                         |                |
| 10303   | Fill  | 10302   | 1.3       | 0.22      | Primary Fill. Dark grey-brown silt clay.                  |                         |                |
| 10304   | Cut   |         |           |           | Natural Feature. Tree-throw hole/rooting                  |                         |                |
| 10305   | Cut   |         | 1.5       | 0.16      | Ditch   |                         |                |
| 10306   | Fill  | 10305   | 1.5       | 0.16      | Primary Fill. Grey-brown silt sand.                       |                         |                |
| 10307   | Cut   |         | 1.9       | 0.3       | Ditch   |                         |                |
| 10308   | Fill  | 10307   | 1.4       | 0.1       | Primary Fill. Compact mottled grey silty clay.            |                         |                |
| 10309   | Fill  | 10307   | 1.9       | 0.26      | Secondary Fill. Moderately compact orange-grey silty clay |                         |                |
| <b>Trench 104</b>   |       |         |           |           |   |                         |                |
| General description   |       |         |           |           | Orientation   |                         | SE-NW          |
| Trench contains two pits, a terminus and a ditch. Trench consists of ploughsoil overlying clay geology.     |       |         |           |           | Length (m)  |                         | 30             |
|   |       |         |           |           | Width (m)   |                         | 2              |
|   |       |         |           |           | Avg. depth (m)  |                         | 0.5            |
| Context No.   | Type  | Fill Of | Width (m) | Depth (m) | Description   | Finds                   | Date           |
| 10400   | Layer |         |           | 0.25      | Ploughsoil. Mid brown clay silt.                          | Flint                   | PH (res)       |
| 10401   | Layer |         |           | 0.15      | Subsoil. Mid red-brown silt clay.                         |                         |                |
| 10402   | Layer |         |           |           | Natural. Brown-yellow sand clay.                          | Pot                     | AD 1270 – 1350 |
| 10403   | Cut   |         | 1.76      | 0.2       | Natural Feature. Reddish grey sandy clay                  | Pot, animal bone        | Roman          |
| 10404   | Cut   |         | 1.89      | 0.32      | Pit   |                         |                |
| 10405   | Fill  | 10404   | 1.89      | 0.32      | Primary Fill. Brownish grey sandy clay                    | Pot, flint, animal bone | AD 1270 – 1350 |
| 10406   | Cut   |         | 0.82      | 0.24      | Ditch   | Pot                     | Roman          |

| 10407  | Fill  | 10406   | 0.82      | 0.24      | Primary Fill.<br>Greyish brown<br>sandy clay                          |               |        |
|--|-------|---------|-----------|-----------|---|---------------|--------|
| <b>Trench 105</b>  |       |         |           |           |   |               |        |
| General description  |       |         |           |           | Orientation   |               | E-W    |
| Trench contains a ditch. Trench consists of ploughsoil<br>overlying clay geology.      |       |         |           |           | Length (m)  |               | 30     |
|  |       |         |           |           | Width (m)   |               | 2      |
|  |       |         |           |           | Avg. depth (m)  |               | 0.45   |
| Context No.  | Type  | Fill Of | Width (m) | Depth (m) | Description   | Finds         | Date   |
| 10500  | Layer |         |           | 0.35      | Ploughsoil. Brown<br>clay silt.                                       |               |        |
| 10501  | Layer |         |           |           | Natural. Mid red-<br>brown silt clay.                                 |               |        |
| 10502  | Cut   |         | 1.48      | 0.62      | Ditch   |               |        |
| 10503  | Fill  | 10502   | 1.2       | 0.12      | Deliberate Backfill.<br>Dark brownish<br>orange silty sandy<br>gravel |               |        |
| 10504  | Fill  | 10502   | 2.07      | 0.48      | Deliberate Backfill.<br>Greyish brown clay<br>silt                    |               |        |
| 10505  | Fill  | 10502   | 0.98      | 0.22      | Deliberate Backfill.<br>Dark greyish black<br>clay silt               | CBM,<br>Fe    | C18-19 |
| <b>Trench 106</b>  |       |         |           |           |   |               |        |
| General description  |       |         |           |           | Orientation   |               | SE-NW  |
| Trench contains two ditches. Trench consists of ploughsoil<br>overlying clay geology.  |       |         |           |           | Length (m)  |               | 30     |
|  |       |         |           |           | Width (m)   |               | 2      |
|  |       |         |           |           | Avg. depth (m)  |               | 0.4    |
| Context No.  | Type  | Fill Of | Width (m) | Depth (m) | Description   | Finds         | Date   |
| 10600  | Layer |         |           | 0.35      | Ploughsoil. Brown<br>clay silt.                                       |               |        |
| 10601  | Layer |         |           |           | Natural. Mid red-<br>brown silt clay.                                 |               |        |
| 10602  | Cut   |         | 0.6       | 0.11      | Ditch   |               |        |
| 10603  | Fill  | 10602   | 0.6       | 0.11      | Primary Fill. Dark<br>grey-brown silty<br>clay                        |               |        |
| 10604  | Cut   |         | 0.73      | 0.27      | Ditch   |               |        |
| 10605  | Fill  | 10604   | 0.73      | 0.27      | Primary Fill. Grey-<br>brown silty clay                               | Pot,<br>flint | MBA-IA |
| <b>Trench 107</b>  |       |         |           |           |   |               |        |
| General description  |       |         |           |           | Orientation   |               | NE-SW  |
| Trench devoid of archaeology. Trench consists of ploughsoil<br>overlying clay geology. |       |         |           |           | Length (m)  |               | 30     |
|  |       |         |           |           | Width (m)   |               | 2      |
|  |       |         |           |           | Avg. depth (m)  |               | 0.3    |
| Context No.  | Type  | Fill Of | Width (m) | Depth (m) | Description   | Finds         | Date   |

|   |       |         |           |           |                                       |       |       |
|---|-------|---------|-----------|-----------|---------------------------------------|-------|-------|
| 10700   | Layer |         |           | 0.25      | Ploughsoil. Brown clay silt.          |       |       |
| 10701   | Layer |         |           |           | Natural. Yellowish brown sand clay.   |       |       |
| <b>Trench 108</b>   |       |         |           |           |                                       |       |       |
| General description   |       |         |           |           | Orientation                           |       | N-S   |
| Trench contains a single ditch. Trench consists of ploughsoil overlying clay geology.                       |       |         |           |           | Length (m)                            |       | 30    |
|   |       |         |           |           | Width (m)                             |       | 2     |
|   |       |         |           |           | Avg. depth (m)                        |       | 0.35  |
| Context No.   | Type  | Fill Of | Width (m) | Depth (m) | Description                           | Finds | Date  |
| 10800   | Layer |         |           | 0.3       | Ploughsoil. Brown clay silt.          |       |       |
| 10801   | Layer |         |           |           | Natural. Brown yellow sand clay.      |       |       |
| 10802   | Cut   |         | 0.53      | 0.12      | Ditch                                 |       |       |
| 10803   | Fill  | 10802   |           | 0.12      | Secondary Fill. Grey-brown clay silt. |       |       |
| <b>Trench 109</b>   |       |         |           |           |                                       |       |       |
| General description   |       |         |           |           | Orientation                           |       | NW-SE |
| Trench devoid of archaeology. Trench consists of ploughsoil over clay sand natural.                         |       |         |           |           | Length (m)                            |       | 30    |
|   |       |         |           |           | Width (m)                             |       | 2     |
|   |       |         |           |           | Avg. depth (m)                        |       | 0.41  |
| Context No.   | Type  | Fill Of | Width (m) | Depth (m) | Description                           | Finds | Date  |
| 10900   | Layer |         |           | 0.39      | Ploughsoil. Brown clay silt           |       |       |
| 10901   | Layer |         |           |           | Natural. Red-brown clay sand          |       |       |
| <b>Trench 110</b>   |       |         |           |           |                                       |       |       |
| General description   |       |         |           |           | Orientation                           |       | N-S   |
| Trench devoid of archaeology. Trench consists of ploughsoil over clay sand natural.                         |       |         |           |           | Length (m)                            |       | 30    |
|   |       |         |           |           | Width (m)                             |       | 2     |
|   |       |         |           |           | Avg. depth (m)                        |       | 0.47  |
| Context No.   | Type  | Fill Of | Width (m) | Depth (m) | Description                           | Finds | Date  |
| 11000   | Layer |         |           | 0.49      | Ploughsoil. Brown clay silt           |       |       |
| 11001   | Layer |         |           |           | Natural. Red-brown clay sand          |       |       |
| <b>Trench 111</b>   |       |         |           |           |                                       |       |       |
| General description   |       |         |           |           | Orientation                           |       | NE-SW |
| Trench contains a posthole, two ditches and terminus. Trench consists of ploughsoil over clay sand geology. |       |         |           |           | Length (m)                            |       | 30    |
|   |       |         |           |           | Width (m)                             |       | 2     |
|   |       |         |           |           | Avg. depth (m)                        |       | 0.53  |
| Context No.   | Type  | Fill Of | Width (m) | Depth (m) | Description                           | Finds | Date  |

|       |       |       |      |      |  |  |  |
|-------|-------|-------|------|------|--|--|--|
| 11100 | Layer |       |      | 0.6  | Ploughsoil. Brown clay silt  |  |  |
| 11101 | Layer |       |      |      | Natural. Red-brown clay sand   |  |  |
| 11102 | Cut   |       | 0.46 | 0.16 | Posthole. Sub-circular moderately sloping concave sided and flat based posthole.   |  |  |
| 11103 | Fill  | 11102 | 0.46 | 0.16 | Deliberate Backfill. Greyish brown moderately compact silty clay with occasional chalk flecks. No finds.                               |  |  |
| 11104 | Cut   |       | 0.92 | 0.38 | Ditch. Linear ditch running NW-SE with moderately sloping concave sides with a concave base. Upper fill (11105) contained a clay pipe. |  |  |
| 11105 | Fill  | 11104 | 0.56 | 0.08 | Deliberate Backfill. Moderately compact greyish brown silty clay with occasional chalk flecks. Contained a clay pipe.                  |  |  |
| 11106 | Cut   |       | 1.34 | 0.2  | Ditch. Linear ditch with moderately sloping concave sides and a concave base running NW-SE.  |  |  |
| 11107 | Fill  | 11104 | 0.64 | 0.32 | Deliberate Backfill. Very compact light brownish grey clayey sand with occasional chalk flecks. No finds.                              |  |  |
| 11108 | Fill  | 11104 | 0.36 | 0.1  | Deliberate Backfill. Moderately compact mid greyish brown silty clay with occasional chalk flecks.                                     |  |  |
| 11109 | Fill  | 11106 | 0.36 | 0.1  | Deliberate Backfill. Moderately compact mottled greyish brown and orangish brown silty clay with occasional chalk flecks.              |  |  |

|       |      |       |      |      |  |  |  |
|-------|------|-------|------|------|--|--|--|
| 11110 | Cut  |       | 0.36 | 0.04 | Ditch. Linear ditch running NE-SW with moderately sloping concave sides and a flat base. |  |  |
| 11111 | Fill | 11110 | 0.36 | 0.04 | Deliberate Backfill. Moderately compact greyish brown silty clay with no inclusions.     |  |  |

### Trench 112

|  |  |  |  |                |  |     |  |
|--|--|--|--|----------------|--|-----|--|
| General description  |  |  |  | Orientation    |  | N-S |  |
| Trench consists of topsoil covering an brownish orange natural |  |  |  | Length (m)     |  | 30  |  |
|  |  |  |  | Width (m)      |  | 2   |  |
|  |  |  |  | Avg. depth (m) |  | 0.4 |  |

| Context No. | Type  | Fill Of | Width (m) | Depth (m) | Description   | Finds            | Date  |
|-------------|-------|---------|-----------|-----------|---|------------------|-------|
| 11200       | Layer |         |           | 0.35      | Ploughsoil. Brown clay silt.                              |                  |       |
| 11201       | Layer |         |           |           | Natural. Yellowish brown silt clay.                       |                  |       |
| 11202       | Cut   |         | 0.93      | 0.14      | Ditch. NW/SE  |                  |       |
| 11203       | Fill  | 11202   | 0.97      | 0.14      | Primary Fill. Dark greyish brown mod compact clayey silt  | Pot              | Roman |
| 11204       | Cut   |         | 1.17      | 0.16      | Ditch. NW/SE  |                  |       |
| 11205       | Fill  | 11204   | 1.17      | 0.16      | Primary Fill. Dark greyish brown clayey silt              |                  |       |
| 11206       | Cut   |         | 1.1       | 0.26      | Ditch. E/W  |                  |       |
| 11207       | Fill  |         | 1.1       | 0.26      | Primary Fill. Light brownish grey mod compact clayey silt | Pot, animal bone | Roman |

### Trench 113

|   |  |  |  |                |  |       |  |
|---|--|--|--|----------------|--|-------|--|
| General description   |  |  |  | Orientation    |  | SE-NW |  |
| Trench contains two pits. Trench consists of ploughsoil overlying clay geology. |  |  |  | Length (m)     |  | 30    |  |
|   |  |  |  | Width (m)      |  | 2     |  |
|   |  |  |  | Avg. depth (m) |  | 0.5   |  |

| Context No. | Type  | Fill Of | Width (m) | Depth (m) | Description                                | Finds | Date |
|-------------|-------|---------|-----------|-----------|--|-------|------|
| 11300       | Layer |         |           | 0.45      | Ploughsoil. Brown clay silt.               |       |      |
| 11301       | Layer |         |           |           | Natural. Red-brown sand clay.              |       |      |
| 11302       | Cut   |         | 0.97      | 0.3       | Pit  |       |      |
| 11303       | Fill  | 11302   | 0.97      | 0.33      | Primary Fill. Grey-brown silty clay. <S3>  |       |      |
| 11304       | Fill  | 11302   | 0.97      | 0.14      | Secondary Fill. Dark grey-brown silty clay |       |      |
| 11305       | Cut   |         | 0.61      | 0.13      | Pit  |       |      |

| 11306  | Fill  | 11305   | 0.61      | 0.13      | Secondary Fill.<br>Grey-brown silty<br>clay                             |             |      |
|--|-------|---------|-----------|-----------|---|-------------|------|
| <b>Trench 114</b>  |       |         |           |           |   |             |      |
| General description  |       |         |           |           | Orientation   |             | N-S  |
| Trench contains a ditch. Trench consists of ploughsoil overlying clay geology.     |       |         |           |           | Length (m)  |             | 30   |
|  |       |         |           |           | Width (m)   |             | 2    |
|  |       |         |           |           | Avg. depth (m)  |             | 0.45 |
| Context No.  | Type  | Fill Of | Width (m) | Depth (m) | Description   | Finds       | Date |
| 11400  | Layer |         |           | 0.35      | Ploughsoil. Brown clay silt.  |             |      |
| 11401  | Layer |         |           |           | Natural. Light yellowish brown silt clay.                               |             |      |
| 11402  | Cut   |         | 0.7       | 0.17      | Ditch   |             |      |
| 11403  | Fill  | 11402   | 0.7       | 0.17      | Primary Fill. Grey-brown silt clay.                                     | Animal bone |      |
| 11404  | Cut   |         | 1.7       | 0.3       | Ditch   |             |      |
| 11405  | Fill  | 11404   | 1.7       | 0.3       | Primary Fill. Moderate grey-brown silty clay                            |             |      |
| <b>Trench 119</b>  |       |         |           |           |   |             |      |
| General description  |       |         |           |           | Orientation   |             | E-W  |
| Trench devoid of archaeology consists of plough soil overlying natural clayey sand |       |         |           |           | Length (m)  |             | 29   |
|  |       |         |           |           | Width (m)   |             | 2    |
|  |       |         |           |           | Avg. depth (m)  |             | 0.4  |
| Context No.  | Type  | Fill Of | Width (m) | Depth (m) | Description   | Finds       | Date |
| 11900  | Layer |         | 2         | 0.4       | Ploughsoil. Greyish brown, sandy silt, loose, rare rounded stones       |             |      |
| 11901  | Layer |         | 2         |           | Natural. Reddish brown, clayey sand, frequent patches of gravel         |             |      |
| <b>Trench 120</b>  |       |         |           |           |   |             |      |
| General description  |       |         |           |           | Orientation   |             | N-S  |
| Contains one linear. Consists of plough soil overlying natural clayey sand.        |       |         |           |           | Length (m)  |             | 30   |
|  |       |         |           |           | Width (m)   |             | 2    |
|  |       |         |           |           | Avg. depth (m)  |             | 0.4  |
| Context No.  | Type  | Fill Of | Width (m) | Depth (m) | Description   | Finds       | Date |
| 12000  | Layer |         | 2         | 0.4       | Ploughsoil. Greyish brown, sandy silt, loose, occasional rounded stones |             |      |
| 12001  | Layer |         | 2         |           | Natural. Reddish brown, clayey sand                                     |             |      |

|       |      |       |      |      |  |  |  |
|-------|------|-------|------|------|--|--|--|
| 12002 | Cut  |       | 1.24 | 0.52 | Ditch. Cut for a E-W running possible boundary ditch.                            |  |  |
| 12003 | Fill | 12002 | 0.28 | 0.06 | Primary Fill. Light greyish yellow silty sand with frequent angular flint gravel |  |  |
| 12004 | Fill | 12002 | 0.32 | 0.1  | Secondary Fill. Light pinkish yellow silty sand                                  |  |  |
| 12005 | Fill | 12002 | 0.43 | 0.06 | Secondary Fill. Light yellowish grey silty sand with no inclusions               |  |  |
| 12006 | Fill | 12002 | 1.05 | 0.26 | Secondary Fill. Yellowish grey silty sand with no inclusions                     |  |  |
| 12007 | Fill | 12002 | 1.24 | 0.14 | Secondary Fill. Pinkish grey silty sand with very rare angular pebbles           |  |  |

#### Trench 121

| General description  |       |         |           |           | Orientation  |       | E-W  |
|--|-------|---------|-----------|-----------|--|-------|------|
| Trench contained one pit. Consists of ploughsoil overlying natural geology of clayey sand. |       |         |           |           | Length (m)   |       | 30   |
|  |       |         |           |           | Width (m)  |       | 2    |
|  |       |         |           |           | Avg. depth (m)   |       | 0.4  |
| Context No.  | Type  | Fill Of | Width (m) | Depth (m) | Description  | Finds | Date |
| 12100  | Layer |         | 2         | 0.4       | Ploughsoil. Greyish brown, sandy silt, occasional rounded stones |       |      |
| 12101  | Layer |         | 2         |           | Natural. Reddish brown, clayey sand, occasional rounded stones   |       |      |
| 12102  | Cut   |         | 0.32      | 0.05      | Pit. Circular pit  |       |      |
| 12103  | Fill  | 12102   | 0.32      | 0.05      | Secondary Fill. Brown orangish, clayey silt, soft.               |       |      |

#### Trench 122

| General description   |       |         |           |           | Orientation                                   |       | NW-SE |
|---|-------|---------|-----------|-----------|---|-------|-------|
| Trench contains one ditch. Consists of plough soil overlaying natural geology of silty clay |       |         |           |           | Length (m)                                    |       | 30    |
|   |       |         |           |           | Width (m)                                     |       | 2     |
|   |       |         |           |           | Avg. depth (m)                                |       | 0.35  |
| Context No.   | Type  | Fill Of | Width (m) | Depth (m) | Description                                   | Finds | Date  |
| 12200   | Layer |         |           | 0.35      | Ploughsoil. Dark grey-brown, silty clay, firm |       |       |
| 12201   | Layer |         |           |           | Natural. Red-brown, silty clay, compact       |       |       |

|       |      |       |      |      |  |                         |              |
|-------|------|-------|------|------|--|-------------------------|--------------|
| 12202 | Cut  |       | 1.36 | 0.36 | Ditch  |                         |              |
| 12203 | Fill | 12202 | 1.1  | 0.22 | Deliberate Backfill. Yellowish brown, clay, compact  | CBM, glass, animal bone | PMed, C18-19 |
| 12204 | Fill | 12202 | 1.36 | 0.14 | Secondary Fill. Dark brown-grey, silty clay, friable |                         |              |

### Trench 123

| General description  |       |         |           |           | Orientation  |       | E-W  |
|--|-------|---------|-----------|-----------|--|-------|------|
| Trench devoid of archaeology consists of plough soil overlying natural clayey sand |       |         |           |           | Length (m)   |       | 39   |
|  |       |         |           |           | Width (m)  |       | 2    |
|  |       |         |           |           | Avg. depth (m)   |       | 0.4  |
| Context No.  | Type  | Fill Of | Width (m) | Depth (m) | Description  | Finds | Date |
| 12300  | Layer |         | 2         | 0.4       | Ploughsoil. Greyish brown, sandy silt, loose, occasional rounded stones  |       |      |
| 12301  | Layer |         | 2         |           | Natural. Reddish brown, clayey sand, rare sub angular and rounded stones |       |      |

### Trench 124

| General description   |       |         |           |           | Orientation   |       | NNW-SSE |
|---|-------|---------|-----------|-----------|---|-------|---------|
| Trench devoid of archaeology. Consists of ploughsoil overlying subsoil and natural. |       |         |           |           | Length (m)  |       | 30      |
|   |       |         |           |           | Width (m)   |       | 2       |
|   |       |         |           |           | Avg. depth (m)  |       | 0.5     |
| Context No.   | Type  | Fill Of | Width (m) | Depth (m) | Description   | Finds | Date    |
| 12400   | Layer |         |           | 0.3       | Ploughsoil. Greyish brown sandy silt with rare pebble inclusions.   |       |         |
| 12401   | Layer |         |           | 0.2       | Subsoil. Light orange-brown sandy silt with no inclusions.  |       |         |
| 12402   | Layer |         |           |           | Natural. Mixed light orange yellow silty sand with frequent gravels and light orange-brown silty sand with no inclusions. |       |         |

### Trench 125

|   |  |  |  |  |             |  |       |
|---|--|--|--|--|-------------|--|-------|
| General description   |  |  |  |  | Orientation |  | NW-SE |
| Trench devoid of archaeology, consists of ploughsoil overlying subsoil and sandy natural. |  |  |  |  | Length (m)  |  | 30    |
|   |  |  |  |  | Width (m)   |  | 2     |



|             |       |         |           |           |   | Avg. depth (m) | 0.45 |
|-------------|-------|---------|-----------|-----------|---|----------------|------|
| Context No. | Type  | Fill Of | Width (m) | Depth (m) | Description   | Finds          | Date |
| 12500       | Layer |         |           | 0.26      | Ploughsoil. Dark orange-brown sandy silt with occasional flint inclusions                                 |                |      |
| 12501       | Layer |         |           | 0.19      | Subsoil. Light orange-brown sandy silt with no inclusions   |                |      |
| 12502       | Layer |         |           |           | Natural. Mixed light yellow-orange and light orange-brown silty sand with rare chalk and flint inclusions |                |      |

### Trench 126

|  |  |  |  |  |                |  |       |
|--|--|--|--|--|----------------|--|-------|
| General description  |  |  |  |  | Orientation    |  | NE-SW |
| Trench devoid of archaeology. One natural feature. Consists of ploughsoil overlying subsoil and natural. |  |  |  |  | Length (m)     |  | 30    |
|  |  |  |  |  | Width (m)      |  | 2     |
|  |  |  |  |  | Avg. depth (m) |  | 0.5   |

| Context No. | Type  | Fill Of | Width (m) | Depth (m) | Description  | Finds | Date |
|-------------|-------|---------|-----------|-----------|--|-------|------|
| 12600       | Layer |         |           | 0.3       | Ploughsoil. Orange-brown sandy silt with no inclusions.                    |       |      |
| 12601       | Layer |         |           | 0.2       | Subsoil. Orange-brown sandy silt with no inclusions.                       |       |      |
| 12602       | Layer |         |           |           | Natural. Mixed light orange-brown sandy silt and light orange yellow sand. |       |      |
| 12603       | Cut   |         | 0.64      | 0.23      | Natural Feature. Dark brown orangish, sandy clay, firm. Possible roots.    |       |      |

### Trench 127

|  |  |  |  |  |                |  |     |
|--|--|--|--|--|----------------|--|-----|
| General description  |  |  |  |  | Orientation    |  | N-S |
| Trench devoid of archaeology. Consists of ploughsoil and subsoil overlying silty clay natural. |  |  |  |  | Length (m)     |  | 30  |
|  |  |  |  |  | Width (m)      |  | 2   |
|  |  |  |  |  | Avg. depth (m) |  | 0.5 |

| Context No. | Type  | Fill Of | Width (m) | Depth (m) | Description   | Finds | Date |
|-------------|-------|---------|-----------|-----------|---|-------|------|
| 12700       | Layer |         |           | 0.29      | Ploughsoil. Greyish brown sandy silt with occasional rounded pebble inclusions. |       |      |

|       |       |  |  |      |  |  |  |
|-------|-------|--|--|------|--|--|--|
| 12701 | Layer |  |  | 0.21 | Subsoil. Light orange-brown sandy silt with frequent gravel inclusions.                                |  |  |
| 12702 | Layer |  |  |      | Natural. Mottled light creamy yellow and yellowish brown silty sand with rare angular flint inclusions |  |  |

### Trench 128

|  |  |  |  |                |  |       |  |
|--|--|--|--|----------------|--|-------|--|
| General description  |  |  |  | Orientation    |  | NE-SW |  |
| Trench devoid of archaeology. Consists of ploughsoil and subsoil overlying silty clay natural. |  |  |  | Length (m)     |  | 30    |  |
|  |  |  |  | Width (m)      |  | 2     |  |
|  |  |  |  | Avg. depth (m) |  | 0.55  |  |

| Context No. | Type  | Fill Of | Width (m) | Depth (m) | Description  | Finds | Date |
|-------------|-------|---------|-----------|-----------|--|-------|------|
| 12800       | Layer |         |           | 0.26      | Ploughsoil. Dark orange-brown sandy silt with no inclusions  |       |      |
| 12801       | Layer |         |           | 0.29      | Subsoil. Light yellowish brown sandy silt with no inclusions   |       |      |
| 12802       | Layer |         |           |           | Natural. Mottled light creamy yellow and mid yellowish brown silty sand with rare angular flint inclusions |       |      |

### Trench 129

|  |  |  |  |                |  |       |  |
|--|--|--|--|----------------|--|-------|--|
| General description  |  |  |  | Orientation    |  | NE-SW |  |
| Trench devoid of archaeology. Consists of ploughsoil overlying natural geology of clayey sand. |  |  |  | Length (m)     |  | 30    |  |
|  |  |  |  | Width (m)      |  | 2     |  |
|  |  |  |  | Avg. depth (m) |  | 0.4   |  |

| Context No. | Type  | Fill Of | Width (m) | Depth (m) | Description  | Finds | Date |
|-------------|-------|---------|-----------|-----------|--|-------|------|
| 12900       | Layer |         |           | 0.33      | Ploughsoil. Dark greyish brown sandy silt with occasional rounded pebbles. |       |      |
| 12901       | Layer |         |           |           | Natural. Reddish orange clayey sand with occasional rounded pebbles.       |       |      |
| 12902       | Layer |         | 0.6       | 0.2       | Remnant Topsoil. Missed topsoil from machining and bioturbation            |       |      |

### Trench 130

| General description  |       |         |           |           | Orientation  |       | N-S     |  |
|--|-------|---------|-----------|-----------|--|-------|---------|--|
| Trench devoid of archaeology. Consists of ploughsoil overlying subsoil and natural.            |       |         |           |           | Length (m)   |       | 30      |  |
|  |       |         |           |           | Width (m)  |       | 2       |  |
|  |       |         |           |           | Avg. depth (m)   |       | 0.55    |  |
| Context No.  | Type  | Fill Of | Width (m) | Depth (m) | Description  | Finds | Date    |  |
| 13000  | Layer |         |           | 0.22      | Ploughsoil. Orange-grey sandy silt with no inclusions.                     |       |         |  |
| 13001  | Layer |         |           | 0.3       | Subsoil. Light orange-brown sandy silt with no inclusions                  |       |         |  |
| 13002  | Layer |         |           |           | Natural. Orange-brown sandy silt with patches of light creamy yellow sand. |       |         |  |
| <b>Trench 131</b>  |       |         |           |           |  |       |         |  |
| General description  |       |         |           |           | Orientation  |       | NNW-SSE |  |
| Trench devoid of archaeology. Consists of ploughsoil overlying natural geology of clayey sand. |       |         |           |           | Length (m)   |       | 30      |  |
|  |       |         |           |           | Width (m)  |       | 2       |  |
|  |       |         |           |           | Avg. depth (m)   |       | 0.32    |  |
| Context No.  | Type  | Fill Of | Width (m) | Depth (m) | Description  | Finds | Date    |  |
| 13100  | Layer |         |           | 0.32      | Ploughsoil. Dark greyish brown sandy silt with occasional rounded pebbles. |       |         |  |
| 13101  | Layer |         |           |           | Natural. Reddish orange clayey sand with occasional rounded pebbles.       |       |         |  |
| <b>Trench 132</b>  |       |         |           |           |  |       |         |  |
| General description  |       |         |           |           | Orientation  |       | NW-SE   |  |
| Trench devoid of archaeology. Consists of ploughsoil overlying natural geology of clayey sand. |       |         |           |           | Length (m)   |       | 30      |  |
|  |       |         |           |           | Width (m)  |       | 2       |  |
|  |       |         |           |           | Avg. depth (m)   |       | 0.34    |  |
| Context No.  | Type  | Fill Of | Width (m) | Depth (m) | Description  | Finds | Date    |  |
| 13200  | Layer |         |           | 0.34      | Ploughsoil. Dark greyish brown sandy silt with occasional rounded pebbles. |       |         |  |
| 13201  | Layer |         |           |           | Natural. Reddish orange clayey sand with occasional rounded pebbles.       |       |         |  |

| Trench 133   |       |         |           |           |   |       |          |
|--|-------|---------|-----------|-----------|---|-------|----------|
| General description  |       |         |           |           | Orientation   |       | NNE-SSW  |
| Trench devoid of archaeology. Consists of ploughsoil overlaying natural geology of clayey sand.  |       |         |           |           | Length (m)  |       | 30       |
|  |       |         |           |           | Width (m)   |       | 2        |
|  |       |         |           |           | Avg. depth (m)  |       | 0.32     |
| Context No.  | Type  | Fill Of | Width (m) | Depth (m) | Description   | Finds | Date     |
| 13300  | Layer |         |           | 0.32      | Ploughsoil. Dark greyish brown sandy silt with occasional rounded pebbles.  |       |          |
| 13301  | Layer |         |           |           | Natural. Brownish orange clayey sand with occasional rounded pebbles.   |       |          |
| Trench 134   |       |         |           |           |   |       |          |
| General description  |       |         |           |           | Orientation   |       | NW-SE    |
| Trench revealed two ditches, one of which truncates another. Consists of ploughsoil overlaying natural geology of clayey sand with gravel. |       |         |           |           | Length (m)  |       | 30       |
|  |       |         |           |           | Width (m)   |       | 2        |
|  |       |         |           |           | Avg. depth (m)  |       | 0.41     |
| Context No.  | Type  | Fill Of | Width (m) | Depth (m) | Description   | Finds | Date     |
| 13400  | Layer |         |           | 0.35      | Ploughsoil. Dark greyish brown sandy silt with occasional rounded pebbles.  |       |          |
| 13401  | Layer |         |           |           | Natural. Brownish orange clayey sand with occasional patches of gravel.   |       |          |
| 13402  | Cut   |         | 1.62      | 0.39      | Ditch   |       |          |
| 13403  | Fill  | 13402   | 1.62      | 0.39      | Secondary Fill. Greyish brown sandy silt with moderate small and fine rounded pebbles and occasional charcoal flecks. | Fe    | PMed/Mod |
| 13404  | Fill  | 13402   | 0.4       | 0.32      | Secondary Fill. Light yellowish grey clayey sand with frequent fine rounded pebbles and occasional shells.            | Glass | C19      |
| 13405  | Cut   |         | 0.5       | 0.23      | Ditch   |       |          |
| 13406  | Fill  | 13405   | 0.5       | 0.23      | Secondary Fill. Greyish brown sandy silt with occasional small and fine pebbles.                                      |       |          |

|       |      |       |   |      |  |  |  |
|-------|------|-------|---|------|--|--|--|
| 13407 | Fill | 13402 | 1 | 0.05 | Primary Fill.<br>Greyish brown<br>sandy silt with<br>occasional fine<br>rounded pebbles. |  |  |
|-------|------|-------|---|------|--|--|--|

### Trench 135

|  |  |  |  |  |                |  |         |
|--|--|--|--|--|----------------|--|---------|
| General description  |  |  |  |  | Orientation    |  | NNW-SSE |
| Trench revealed one ditch. Consists of ploughsoil overlaying natural geology of clayey sand. |  |  |  |  | Length (m)     |  | 30      |
|  |  |  |  |  | Width (m)      |  | 2       |
|  |  |  |  |  | Avg. depth (m) |  | 0.4     |

| Context No. | Type  | Fill Of | Width (m) | Depth (m) | Description  | Finds | Date |
|-------------|-------|---------|-----------|-----------|--|-------|------|
| 13500       | Layer |         |           | 0.4       | Ploughsoil. Dark greyish brown sandy silt with occasional rounded pebbles.                                 |       |      |
| 13501       | Layer |         |           |           | Natural. Brownish orange clayey sand with occasional rounded pebbles                                       |       |      |
| 13502       | Cut   |         | 1.4       | 0.7       | Ditch  |       |      |
| 13503       | Fill  | 13502   | 0.7       | 0.24      | Secondary Fill. Brownish grey sandy silt with moderate chalk flecks.                                       |       |      |
| 13504       | Fill  | 13502   | 1.4       | 0.7       | Secondary Fill. Greyish brown sandy silt with moderate fine and small rounded pebbles, occasional shells.  |       |      |
| 13505       | Fill  | 13502   | 0.5       | 0.12      | Primary Fill. Brownish grey sandy silt with occasional charcoal flecks.                                    |       |      |
| 13506       | Fill  | 13502   | 0.7       | 0.24      | Secondary Fill. Light yellowish grey clayey sand with frequent fine rounded pebbles and occasional shells. |       |      |

### Trench 136

|   |  |  |  |  |                |  |       |
|---|--|--|--|--|----------------|--|-------|
| General description   |  |  |  |  | Orientation    |  | NW-SE |
| Trench contained three cremation deposits and two NW-SE running linears. Consists of ploughsoil and subsoil overlying sandy gravel natural. |  |  |  |  | Length (m)     |  | 30    |
|   |  |  |  |  | Width (m)      |  | 2     |
|   |  |  |  |  | Avg. depth (m) |  | 0.44  |

| Context No. | Type | Fill Of | Width (m) | Depth (m) | Description | Finds | Date |
|-------------|------|---------|-----------|-----------|-------------|-------|------|
|-------------|------|---------|-----------|-----------|-------------|-------|------|

|       |       |       |      |      |   |       |                  |
|-------|-------|-------|------|------|---|-------|------------------|
| 13600 | Layer |       |      | 0.33 | Ploughsoil. Orange-brown sandy silt with occasional rounded pebbles   |       |                  |
| 13601 | Layer |       |      | 0.12 | Subsoil. Light greyish orange sandy silt with occasional gravels  |       |                  |
| 13602 | Layer |       |      |      | Natural. Light yellow-orange sandy gravel   |       |                  |
| 13603 | Cut   |       | 0.68 | 0.16 | Ditch. Gully  |       |                  |
| 13604 | Fill  | 13603 | 0.68 | 0.16 | Secondary Fill. Light greyish brown, moderately compact, sandy silt with frequent gravel  |       |                  |
| 13605 | Cut   |       | 1.3  | 0.36 | Ditch   |       |                  |
| 13606 | Fill  | 13605 | 1.3  | 0.36 | Secondary Fill. Light greyish brown, sandy silt with gavel  |       |                  |
| 13607 | Cut   |       | 1.5  | 0.18 | Natural Feature   |       |                  |
| 13608 | Cut   |       | 1.1  | 0.42 | Tree Throw  |       |                  |
| 13609 | Cut   |       | 0.65 | 0.2  | Cremation Cut   |       |                  |
| 13610 | Cut   |       | 1.1  | 0.2  | Cremation Cut   |       |                  |
| 13611 | Fill  | 13610 | 1.1  | 0.2  | Cremation Deposit. Dark brown, loose, clayey sand with charcoal and occasional fired flint, cremated bones, sub-angular and rounded stones. <S4-S7> | Flint | 1690-1510 cal BC |
| 13612 | Fill  | 13609 | 0.65 | 0.2  | Cremation Deposit <S8>, <S11-12>, <S15>, <S18>, <20>, <S24>   | Flint |                  |
| 13613 | Cut   |       | 0.34 | 0.09 | Cremation Cut. Not observed to be a separate cut until first spit removed from (13612)  |       |                  |
| 13614 | Fill  | 13613 | 0.34 | 0.09 | Cremation Deposit. Dark greyish black sandy silt with frequent burnt bone inclusions. <S10>, <S13>, <S16-17>, <S19>, <S23>                          | Flint |                  |
| 13615 | Fill  | 13609 | 0.33 | 0.03 | Primary Fill. Light brownish grey sandy silt with no inclusions. <S21>  |       |                  |

| <b>Trench 137</b>   |       |         |           |           |  |           |                            |
|---|-------|---------|-----------|-----------|--|-----------|----------------------------|
| General description   |       |         |           |           | Orientation  |           | NW-SE                      |
| Trench contains one linear. Consists of ploughsoil overlaying natural geology of sandy gravel.            |       |         |           |           | Length (m)   |           | 30                         |
|   |       |         |           |           | Width (m)  |           | 2                          |
|   |       |         |           |           | Avg. depth (m)   |           | 0.33                       |
| Context No.   | Type  | Fill Of | Width (m) | Depth (m) | Description  | Finds     | Date                       |
| 13700   | Layer |         |           |           | Ploughsoil. Dark greyish brown with occasional rounded pebbles.  |           |                            |
| 13701   | Layer |         |           |           | Natural. Orangish brown sandy gravel.  |           |                            |
| 13702   | Cut   |         | 1.6       | 0.36      | Natural Feature  |           |                            |
| 13703   | Cut   |         | 0.78      | 0.2       | Ditch. Gully   |           |                            |
| 13704   | Fill  |         | 0.78      | 0.2       | Secondary Fill. Light greyish brown, clayey sand, loose, occasional rounded pebbles                                |           |                            |
| <b>Trench 139</b>   |       |         |           |           |  |           |                            |
| General description   |       |         |           |           | Orientation  |           | NE-SW                      |
| Trench contains one linear. Consists of ploughsoil overlaying natural geology of clayey sand with gravel. |       |         |           |           | Length (m)   |           | 30                         |
|   |       |         |           |           | Width (m)  |           | 2                          |
|   |       |         |           |           | Avg. depth (m)   |           | 0.41                       |
| Context No.   | Type  | Fill Of | Width (m) | Depth (m) | Description  | Finds     | Date                       |
| 13900   | Layer |         |           | 0.33      | Ploughsoil. Dark greyish brown silty sand with occasional rounded pebbles.   |           |                            |
| 13901   | Layer |         |           |           | Natural. Reddish orange clayey sand merging with gravel.   |           |                            |
| 13902   | Cut   |         | 2         | 0.66      | Ditch  |           |                            |
| 13903   | Fill  | 13902   | 1         | 0.2       | Primary Fill. Light greyish white with orange lenses. Silty sand, firm. Finds of pot and coin (sf 1)               | Pot, Coin | AD 1–150 (res), AD 260–296 |
| 13904   | Fill  | 13902   | 2         | 0.46      | Secondary Fill. Grey-brown with areas of charcoal. Silty clay, Some small stone and flint inclusions. Finds of pot | Pot       | AD 43–70                   |

| <b>Trench 140</b>  |       |         |           |           |  |            |                       |
|--|-------|---------|-----------|-----------|--|------------|-----------------------|
| General description  |       |         |           |           | Orientation  |            | E-W                   |
| Contains two ditches. Consists of ploughsoil overlaying natural geology of clayey sand and gravel.                                       |       |         |           |           | Length (m)   |            | 30                    |
|  |       |         |           |           | Width (m)  |            | 2                     |
|  |       |         |           |           | Avg. depth (m)   |            | 0.5                   |
| Context No.  | Type  | Fill Of | Width (m) | Depth (m) | Description  | Finds      | Date                  |
| 14000  | Layer |         |           | 0.4       | Ploughsoil. Dark greyish brown silty sand with occasional rounded pebbles. |            |                       |
| 14001  | Layer |         |           |           | Natural. Brownish orange clayey sand merging with gravel.                  |            |                       |
| 14002  | Cut   |         | 3.2       | 0.6       | Ditch. Enclosure ditch   |            |                       |
| 14003  | Fill  | 14002   | 0.5       | 0.1       | Secondary Fill. Very compact greyish orange-brown clayey silt              |            |                       |
| 14004  | Fill  | 14002   | 0.1       | 0.08      | Secondary Fill. Compact, Brownish orange sandy silt.                       |            |                       |
| 14005  | Fill  | 14002   | 2.8       | 0.42      | Secondary Fill. Moderately compact mid brown sandy silt.                   | Pot, flint | AD 50–270, Preh (res) |
| 14006  | Fill  | 14002   | 2.1       | 0.25      | Secondary Fill. Moderately compact dark brown sandy silt                   |            |                       |
| 14007  | Cut   |         | 1.7       | 0.32      | Ditch. N-S ditch   |            |                       |
| 14008  | Fill  | 14007   | 1.7       | 0.32      | Secondary Fill. Brown sandy silt   | Pot        | AD 120–250            |
| <b>Trench 141</b>  |       |         |           |           |  |            |                       |
| General description  |       |         |           |           | Orientation  |            | E-W                   |
| Trench revealed seven ditches and one posthole. Consists of ploughsoil and subsoil overlaying natural geology of clayey sand and gravel. |       |         |           |           | Length (m)   |            | 30                    |
|  |       |         |           |           | Width (m)  |            | 2                     |
|  |       |         |           |           | Avg. depth (m)   |            | 0.61                  |
| Context No.  | Type  | Fill Of | Width (m) | Depth (m) | Description  | Finds      | Date                  |
| 14100  | Layer |         |           | 0.4       | Ploughsoil. Dark greyish brown sandy silt with occasional rounded pebbles. |            |                       |
| 14101  | Layer |         |           | 0.2       | Subsoil. Reddish brown sandy silt with rounded pebbles.                    |            |                       |
| 14102  | Layer |         |           |           | Natural. Brownish orange and yellow clayey sand                            |            |                       |



|       |      |       |      |      |   |     |                |
|-------|------|-------|------|------|---|-----|----------------|
|       |      |       |      |      | merging with gravel.  |     |                |
| 14103 | Cut  |       | 0.64 | 0.34 | Ditch. Possible curvilinear, Roundhouse?                                |     |                |
| 14104 | Fill | 14103 | 0.64 | 0.34 | Secondary Fill. Dark brown, sandy silt, soft.                           |     |                |
| 14105 | Cut  |       | 0.91 | 0.3  | Ditch. Possible enclosure ditch   |     |                |
| 14106 | Fill | 14105 | 0.91 | 0.3  | Secondary Fill. Orange-brownish, sandy silt, soft.                      |     |                |
| 14107 | Cut  |       | 0.82 | 0.4  | Ditch. Possible enclosure ditch   |     |                |
| 14108 | Fill | 14107 | 0.82 | 0.4  | Secondary Fill. Dark brown, sandy silt, soft.                           |     |                |
| 14109 | Cut  |       | 0.76 | 0.42 | Ditch. Enclosure ditch.   |     |                |
| 14110 | Fill | 14109 | 0.76 | 0.42 | Secondary Fill. Dark brown orangish, sandy silt, soft.                  |     |                |
| 14111 | Cut  |       | 1.31 | 0.14 | Ditch   |     |                |
| 14112 | Fill | 14111 | 1.31 | 0.14 | Primary Fill. Light brown-orange Sand                                   |     |                |
| 14113 | Cut  |       | 1.35 | 0.23 | Ditch   |     |                |
| 14114 | Fill | 14113 | 1.35 | 0.23 | Primary Fill. dark brown Sandy Small stones                             |     |                |
| 14115 | Cut  |       |      | 0.66 | Ditch   |     |                |
| 14116 | Fill | 14115 |      | 0.18 | Primary Fill. Grey orangish/brownish, silt, compact.                    | Pot | AD 1175 – 1400 |
| 14117 | Fill | 14115 |      | 0.36 | Secondary Fill. Light brown whitish, silt, compact.                     |     |                |
| 14118 | Cut  |       | 0.36 | 0.14 | Posthole  |     |                |
| 14119 | Fill | 14118 | 0.36 | 0.14 | Other Fill. Brown, sandy silt, soft.                                    |     |                |
| 14120 | Fill | 14115 |      | 0.16 | Secondary Fill. Brown orangish/greyish, sandy silt, moderately compact. |     |                |

#### Trench 142

|  |                |         |
|--|----------------|---------|
| General description  | Orientation    | E-W/N-S |
| Trench contains three linears and a tree-throw. Consists of ploughsoil overlying gravel natural. | Length (m)     | 30      |
|  | Width (m)      | 2       |
|  | Avg. depth (m) | 0.41    |

| Context No.         | Type  | Fill Of | Width (m) | Depth (m) | Description   | Finds            | Date                   |
|---------------------|-------|---------|-----------|-----------|---|------------------|------------------------|
| 14200               | Layer |         |           | 0.41      | Ploughsoil. Dark grey-brown, silty clay, friable  |                  |                        |
| 14201               | Layer |         |           | 0.15      | Subsoil. Orange-brown, silty clay, friable  |                  |                        |
| 14202               | Layer |         |           |           | Natural. Brown-orange, sandy clay, friable, frequent gravel inclusions  |                  |                        |
| 14203               | Cut   |         | 0.54      | 0.17      | Ditch. shallow ditch  |                  |                        |
| 14204               | Fill  | 14203   | 0.54      | 0.17      | Primary Fill. Brown Sand Small stones   | Pot, animal bone | UD                     |
| 14205               | Cut   |         | 0.96      | 0.6       | Pit. Pit or ditch terminus - unclear due to trench location   |                  |                        |
| 14206               | Fill  | 14205   | 0.7       | 0.14      | Deliberate Backfill. Very dark grey sandy loam with occasional small burnt stones, moderate fired clay and frequent charcoal fragments. <S14>. Base of deposit not reached. | Pot, CBM, flint  | AD 180–250, Preh (res) |
| 14207               | Cut   |         | 0.35      | 0.06      | Ditch. cut of shallow ditch   |                  |                        |
| 14208               | Fill  | 14207   | 0.35      | 0.06      | Primary Fill. light brown Sand One piece of modern pottery  | Pot              | EP, Med                |
| 14209               | Fill  | 14205   | 0.8       | 0.22      | Secondary Fill. Yellowish brown sandy silt with moderate small and fine rounded pebbles, rare charcoal flecks.  | Pot              | Roman                  |
| 14210               | Fill  | 14205   | 0.96      | 0.28      | Secondary Fill. Greyish brown sandy silt with moderate small and fine rounded pebbles.  |                  |                        |
| 14211               | Void  |         |           |           |   |                  |                        |
| 14212               | Void  |         |           |           |   |                  |                        |
| 14213               | Void  |         |           |           |   |                  |                        |
| <b>Trench 143</b>   |       |         |           |           |   |                  |                        |
| General description |       |         |           |           | Orientation   |                  | E-W                    |
|                     |       |         |           |           | Length (m)  |                  | 30                     |

| Trench has two ditches. Consists of ploughsoil overlying gravel natural. |                     |         |           |           | Width (m)   | 2           |            |
|--|---------------------|---------|-----------|-----------|---|-------------|------------|
|  |                     |         |           |           | Avg. depth (m)  | 0.43        |            |
| Context No.  | Type                | Fill Of | Width (m) | Depth (m) | Description   | Finds       | Date       |
| 14300  | Layer               |         |           | 0.27      | Ploughsoil. Dark grey-brown, silty clay, friable                        |             |            |
| 14301  | Layer               |         |           | 0.16      | Subsoil. Orange-brown, silty clay, friable                              |             |            |
| 14302  | Layer               |         |           |           | Natural. Brown-orange, sandy clay, friable, frequent gravel inclusions  |             |            |
| 14303  | Cut                 |         | 0.65      | 0.3       | Ditch   |             |            |
| 14304  | Fill                | 14303   | 0.65      | 0.3       | Secondary Fill. Dark brown orangish, sandy silt, soft.                  |             |            |
| 14305  | Cut                 |         | 0.7       | 0.4       | Ditch. Enclosure ditch?   |             |            |
| 14306  | Fill                | 14305   | 0.56      | 0.16      | Primary Fill. Grey-brownish, sandy silt, moderately compact.            |             |            |
| 14307  | Fill                | 14305   | 0.7       | 0.25      | Secondary Fill. Dark brown, sandy silt, soft.                           | Pot, stone  | Roman      |
| 14308  | Cut                 |         | 0.9       | 0.1       | Natural Feature. Brown orangish, sandy silt, soft. Possible tree-throw. |             |            |
| 14309  | Cut                 |         | 0.85      | 0.3       | Ditch   |             |            |
| 14310  | Fill                | 14309   | 0.52      | 0.22      | Secondary Fill. Grey orangish, sandy silt, compact. <S9>                | Animal bone |            |
| 14311  | Fill                | 14309   | 0.85      | 0.08      | Secondary Fill. Brown orangish, sandy silt, soft.                       |             |            |
| 14312  | Cut                 |         | 2         | 0.5       | Ditch. Not fully excavated  |             |            |
| 14313  | Fill                | 14312   | 1.16      |           | Secondary Fill. Grey orangish/brownish, silt, compact.                  | Pot         | AD 170–230 |
| 14314  | Fill                | 14312   |           | 0.36      | Secondary Fill. Light brown whitish, silt, compact.                     |             |            |
| 14315  | Cut                 |         | 0.68      | 0.14      | Pit   |             |            |
| 14316  | Fill                | 14315   | 0.68      | 0.14      | Secondary Fill. Brown orangish, sandy silt, soft.                       |             |            |
| 14317  | Unexcavated feature |         | 1.45      |           | Pit. Unexcavated pit, truncated by [14319]. Fill is mid                 |             |            |

|       |                     |       |      |      |  |  |  |
|-------|---------------------|-------|------|------|--|--|--|
|       |                     |       |      |      | brownish grey silty sand with occasional charcoal flecks.  |  |  |
| 14318 | Unexcavated feature |       | 0.88 |      | Pit. Unexcavated pit, truncated by [14319] and [14317]. Fill is mid brownish grey with charcoal flecks.                                  |  |  |
| 14319 | Unexcavated feature |       | 1.88 |      | Pit. Unexcavated pit part of a pit group at eastern end of TR 143. Fill is mid brownish grey silty sand with occasional charcoal flecks. |  |  |
| 14320 | Cut                 |       | 1.6  | 0.45 | Ditch  |  |  |
| 14321 | Fill                | 14320 | 1.28 | 0.35 | Primary Fill. Light greyish white with orange and black lenses. Silty sand, firm.  |  |  |
| 14322 | Fill                |       | 1.6  | 0.1  | Secondary Fill. Dark brown-grey, silty clay  |  |  |

#### Trench 144

| General description   |       |         |           |           | Orientation  | E-W   |      |
|---|-------|---------|-----------|-----------|--|-------|------|
| Trench contains two ditches and a pit. Consists of ploughsoil overlying gravel natural. |       |         |           |           | Length (m)   | 30    |      |
|   |       |         |           |           | Width (m)  | 2     |      |
|   |       |         |           |           | Avg. depth (m)   | 0.4   |      |
| Context No.   | Type  | Fill Of | Width (m) | Depth (m) | Description  | Finds | Date |
| 14400   | Layer |         |           | 0.26      | Ploughsoil. Dark grey-brown, silty clay, friable                       |       |      |
| 14401   | Layer |         |           | 0.14      | Subsoil. Orange-brown, silty clay, friable                             |       |      |
| 14402   | Layer |         |           |           | Natural. Brown-orange, sandy clay, friable, frequent gravel inclusions |       |      |
| 14403   | Cut   |         | 1.33      | 0.2       | Natural Feature. light brown-yellow Small stones Sand                  |       |      |
| 14404   | Cut   |         | 0.96      | 0.03      | Natural Feature. Light brown/yellow sand. Occasional small stones      |       |      |
| 14405   | Cut   |         | 0.24      | 0.02      | Natural Feature. light brown/ yellow Sand                              |       |      |
| 14406   | Cut   |         | 1.36      | 0.24      | Ditch  |       |      |

| 14407  | Fill  | 14406   | 1.66      | 0.24      | Secondary Fill. Dark brown sand, abundant small stones, yellow-orange sand in the NE corner | Pot   | Roman      |
|--|-------|---------|-----------|-----------|---|-------|------------|
| <b>Trench 145</b>  |       |         |           |           |   |       |            |
| General description  |       |         |           |           | Orientation   |       | N-S        |
| Contains dense archaeology of three linears and four pits. Trench consists of ploughsoil overlying gravel natural. |       |         |           |           | Length (m)  |       | 30         |
|  |       |         |           |           | Width (m)   |       | 2          |
|  |       |         |           |           | Avg. depth (m)  |       | 0.45       |
| Context No.  | Type  | Fill Of | Width (m) | Depth (m) | Description   | Finds | Date       |
| 14500  | Layer |         |           | 0.45      | Ploughsoil. Dark orange-brown sandy silt with frequent rounded pebbles                      |       |            |
| 14501  | Layer |         |           |           | Natural. Light yellow-orange sandy gravels with frequent rounded pebbles                    |       |            |
| 14502  | Cut   |         | 1.04      | 0.38      | Ditch   |       |            |
| 14503  | Fill  | 14502   | 0.9       | 0.12      | Primary Fill. Loose, mid greyish brown silty sand   |       |            |
| 14504  | Fill  | 14502   | 0.18      | 0.2       | Secondary Fill. Soft, mid yellowish brown sandy silt  |       |            |
| 14505  | Fill  | 14502   | 0.9       | 0.32      | Secondary Fill. Soft, mid grey-brown silty sand   |       |            |
| 14506  | Cut   |         | 0.6       | 0.3       | Pit   |       |            |
| 14507  | Fill  | 14506   | 0.6       | 0.3       | Secondary Fill. Soft, light brownish grey silty sand  |       |            |
| 14508  | Cut   |         | 0.6       | 0.16      | Pit   |       |            |
| 14509  | Fill  | 14508   | 0.6       | 0.3       | Secondary Fill. Soft, mid greyish brown sandy silt  |       |            |
| 14510  | Cut   |         | 0.62      | 0.32      | Ditch. truncated by machine   |       |            |
| 14511  | Fill  | 14510   | 0.6       | 0.32      | Secondary Fill. Loose greyish brown silty sand  |       |            |
| 14512  | Fill  | 14510   | 0.62      | 0.15      | Secondary Fill. Soft brownish grey sandy silt   | Pot   | AD 170–250 |
| 14513  | Cut   |         | 1.2       | 0.4       | Ditch. Truncated by machine   |       |            |
| 14514  | Fill  | 14513   | 1.2       | 0.4       | Secondary Fill. Soft dark brownish black sandy silt   |       |            |
| 14515  | Cut   |         | 0.62      | 0.38      | Pit   |       |            |

|       |                     |       |      |      |  |  |  |
|-------|---------------------|-------|------|------|--|--|--|
| 14516 | Fill                | 14515 | 0.62 | 0.35 | Secondary Fill. Soft, greyish brown sandy silt |  |  |
| 14517 | Unexcavated feature |       | 1    |      | Pit. Greyish brown, soft, sandy silt fill.     |  |  |
| 14518 | Unexcavated feature |       | 0.65 |      | Pit. Greyish brown, soft, sandy silt fill      |  |  |

#### Trench 146

|  |  |  |  |                |  |       |  |
|--|--|--|--|----------------|--|-------|--|
| General description  |  |  |  | Orientation    |  | NW-SE |  |
| Trench contains one ditch. Trench consists of ploughsoil overlying gravel natural. |  |  |  | Length (m)     |  | 20    |  |
|  |  |  |  | Width (m)      |  | 2     |  |
|  |  |  |  | Avg. depth (m) |  | 0.42  |  |

| Context No. | Type  | Fill Of | Width (m) | Depth (m) | Description   | Finds | Date |
|-------------|-------|---------|-----------|-----------|---|-------|------|
| 14600       | Layer |         |           | 0.35      | Ploughsoil. Dark grey-brown, silty clay, friable  |       |      |
| 14601       | Layer |         |           |           | Natural. Brown orange, sandy clay, friable, frequent gravel inclusions                        |       |      |
| 14602       | Cut   |         | 0.9       | 0.3       | Ditch   |       |      |
| 14603       | Fill  | 14602   | 0.9       | 0.3       | Secondary Fill. Soft orange-brown silty sand  |       |      |
| 14604       | Cut   |         | 1.63      |           | Natural Feature. Greyish brown soft silty sand fill. Moderate sub rounded stones.             |       |      |
| 14605       | Cut   |         | 1.45      |           | Natural Feature. Greyish brown, loose, silty sand fill. Frequent sub rounded stone inclusions |       |      |

#### Trench 147

|  |  |  |  |                |  |       |  |
|--|--|--|--|----------------|--|-------|--|
| General description  |  |  |  | Orientation    |  | NW-SE |  |
| Trench revealed three ditches, two postholes and one potential pit which was left unexcavated. Consists of ploughsoil overlying natural geology of sandy gravel. |  |  |  | Length (m)     |  | 30    |  |
|  |  |  |  | Width (m)      |  | 2     |  |
|  |  |  |  | Avg. depth (m) |  | 0.4   |  |

| Context No. | Type  | Fill Of | Width (m) | Depth (m) | Description  | Finds | Date |
|-------------|-------|---------|-----------|-----------|--|-------|------|
| 14700       | Layer |         |           | 0.4       | Ploughsoil. Dark orange-brown sandy silt with frequent flint pebble inclusions |       |      |
| 14701       | Layer |         |           |           | Natural. Light yellow-orange sandy gravel with occasional pebbles              |       |      |
| 14702       | Cut   |         | 0.63      | 0.21      | Ditch  |       |      |

|       |                     |       |      |      |   |     |        |
|-------|---------------------|-------|------|------|---|-----|--------|
| 14703 | Fill                | 14702 | 0.63 | 0.21 | Secondary Fill. Greyish brown silty sand and gravel with occasional charcoal flecks.  | Pot | MBA-IA |
| 14704 | Cut                 |       | 0.7  | 0.12 | Ditch. Ditch terminus   |     |        |
| 14705 | Fill                | 14704 | 0.7  | 0.12 | Secondary Fill. Orangish brown silty sand and gravel with occasional sub-angular flint fragments.                             |     |        |
| 14706 | Cut                 |       | 0.31 | 0.11 | Pit   |     |        |
| 14707 | Fill                | 14706 | 0.31 | 0.11 | Secondary Fill. Greyish brown silty sand with frequent medium and small sub-angular flint nodules.                            |     |        |
| 14708 | Cut                 |       | 0.9  | 0.3  | Ditch   |     |        |
| 14709 | Fill                | 14708 | 0.9  | 0.3  | Secondary Fill. Greyish brown silty sand and gravel with occasional charcoal flecks and moderate sub-angular flint fragments. |     |        |
| 14710 | Cut                 |       | 0.3  | 0.28 | Posthole  |     |        |
| 14711 | Fill                | 14710 | 0.3  | 0.28 | Deliberate Backfill. Dark brownish grey silty sand and gravel with occasional sub-angular flint inclusions.                   | Pot | MBA-IA |
| 14712 | Unexcavated feature |       | 0.7  |      | Pit   |     |        |

### Trench 148

| General description  |       |         |           |           | Orientation  | N-S   |      |
|--|-------|---------|-----------|-----------|--|-------|------|
| Dense archaeology of four linears and 25 pits/postholes. Trench consists of ploughsoil overlying gravel natural. |       |         |           |           | Length (m)   | 17    |      |
|  |       |         |           |           | Width (m)  | 14.5  |      |
|  |       |         |           |           | Avg. depth (m)   | 0.36  |      |
| Context No.  | Type  | Fill Of | Width (m) | Depth (m) | Description  | Finds | Date |
| 14800  | Layer |         |           | 0.36      | Ploughsoil. Dark orange-brown sandy silt with frequent rounded pebbles |       |      |
| 14801  | Layer |         |           |           | Natural. Light yellow-orange sandy gravel with                         |       |      |

|       |      |       |      |      |  |            |           |
|-------|------|-------|------|------|--|------------|-----------|
|       |      |       |      |      | frequent rounded pebbles   |            |           |
| 14802 | Cut  |       | 0.9  | 0.2  | Ditch  |            |           |
| 14803 | Fill | 14802 | 0.9  | 0.2  | Primary Fill. Grey-brown, silty clay, frequent stone/flint inclusions, finds of pot  | Pot        | Roman     |
| 14804 | Cut  |       | 0.3  | 0.04 | Pit  |            |           |
| 14805 | Fill | 14804 | 0.3  | 0.04 | Primary Fill. Dark charcoal rich deposit. <S2>                                       | Pot, flint | AD 43–150 |
| 14806 | Cut  |       | 0.94 | 0.16 | Ditch. Uneven along length, rooted in about 50%                                      |            |           |
| 14807 | Fill | 14806 | 0.94 | 0.16 | Secondary Fill. Greyish brown gravely silt.  |            |           |
| 14808 | Cut  |       | 0.27 | 0.32 | Stake hole. not visible on the surface.  |            |           |
| 14809 | Fill | 14808 | 0.27 | 0.32 | Secondary Fill. Light grey sandy silt  |            |           |
| 14810 | Cut  |       | 0.5  | 0.12 | Natural Feature. Overlying [14808] and [14806]                                       |            |           |
| 14811 | Cut  |       | 0.6  | 0.18 | Posthole   |            |           |
| 14812 | Fill | 14811 | 0.6  | 0.18 | Primary Fill. Grey-brown, sandy silt, frequent stone and flint inclusions, no finds  |            |           |
| 14813 | Cut  |       | 1.5  | 0.48 | Ditch  |            |           |
| 14814 | Fill |       | 0.56 | 0.14 | Primary Fill. Grey-brown, sandy silt, rare inclusions, no finds                      |            |           |
| 14815 | Fill | 14813 | 1.5  | 0.34 | Tertiary Fill. Grey-brown, sandy silt, frequent stone and flint inclusions, no finds |            |           |
| 14816 | Cut  |       | 0.98 | 0.26 | Pit. Shallow wide pit.   |            |           |
| 14817 | Fill | 14816 | 0.98 | 0.26 | Secondary Fill. Dark brown sandy silt.   |            |           |
| 14818 | Cut  |       | 0.48 | 0.28 | Ditch. Linear ditch  |            |           |
| 14819 | Fill | 14818 | 0.48 | 0.28 | Secondary Fill. Dark brown sandy silt.   |            |           |
| 14820 | Cut  |       | 1.26 | 0.38 | Ditch. Linear ditch  |            |           |
| 14821 | Fill | 14820 | 1.26 | 0.38 | Secondary Fill. Black sandy silt with moderate                                       | Pot        | Roman     |



|       |                     |       |      |      |   |  |  |
|-------|---------------------|-------|------|------|---|--|--|
|       |                     |       |      |      | stones and roman pot.   |  |  |
| 14822 | Cut                 |       | 1.11 | 0.25 | Pit. Shallow pit  |  |  |
| 14823 | Fill                | 14822 | 1.11 | 0.25 | Secondary Fill. Blackish brown silty sand                                 |  |  |
| 14824 | Unexcavated feature |       | 0.25 |      | Posthole. Filled by dark blackish brown silty sand with frequent gravels. |  |  |
| 14825 | Unexcavated feature |       | 0.16 |      | Posthole. Filled by dark blackish brown silty sand with frequent gravels. |  |  |
| 14826 | Unexcavated feature |       | 0.28 |      | Posthole. Filled by dark blackish brown silty sand with frequent gravels. |  |  |
| 14827 | Unexcavated feature |       | 0.6  |      | Pit. Filled by dark blackish brown silty sand with frequent gravels.      |  |  |
| 14828 | Unexcavated feature |       | 0.18 |      | Posthole. Filled by dark blackish brown silty sand with frequent gravels. |  |  |
| 14829 | Unexcavated feature |       | 0.7  |      | Pit   |  |  |
| 14830 | Unexcavated feature |       | 0.8  |      | Posthole. Filled by dark blackish brown silty sand with frequent gravels. |  |  |
| 14831 | Unexcavated feature |       | 0.6  |      | Posthole. Filled by dark blackish brown silty sand with frequent gravels. |  |  |
| 14832 | Unexcavated feature |       | 0.42 |      | Posthole. Filled by dark blackish brown silty sand with frequent gravels. |  |  |
| 14833 | Unexcavated feature |       | 0.53 |      | Posthole. Filled by dark blackish brown silty sand with frequent gravels. |  |  |
| 14834 | Unexcavated feature |       | 0.6  |      | Posthole. Filled by dark blackish brown silty sand with frequent gravels. |  |  |
| 14835 | Unexcavated feature |       | 0.23 |      | Posthole. Filled by dark blackish   |  |  |

|       |                     |  |      |      |   |  |  |
|-------|---------------------|--|------|------|---|--|--|
|       |                     |  |      |      | brown silty sand with frequent gravels.                                   |  |  |
| 14836 | Unexcavated feature |  | 0.33 |      | Posthole. Filled by dark blackish brown silty sand with frequent gravels. |  |  |
| 14837 | Unexcavated feature |  | 0.3  |      | Posthole. Filled by dark blackish brown silty sand with frequent gravels. |  |  |
| 14838 | Cut                 |  | 0.29 | 0.09 | Posthole  |  |  |
| 14839 | Unexcavated feature |  | 0.18 |      | Posthole. Filled by dark blackish brown silty sand with frequent gravels. |  |  |
| 14840 | Unexcavated feature |  | 0.15 |      | Posthole. Filled by dark blackish brown silty sand with frequent gravels. |  |  |
| 14841 | Unexcavated feature |  | 0.31 |      | Posthole. Filled by dark blackish brown silty sand with frequent gravels. |  |  |
| 14842 | Unexcavated feature |  | 0.18 |      | Posthole. Filled by dark blackish brown silty sand with frequent gravels. |  |  |
| 14843 | Cut                 |  | 0.3  | 0.09 | Posthole  |  |  |
| 14844 | Unexcavated feature |  | 0.2  |      | Posthole. Filled by dark blackish brown silty sand with frequent gravels. |  |  |
| 14845 | Unexcavated feature |  | 0.35 |      | Posthole. Filled by dark blackish brown silty sand with frequent gravels. |  |  |
| 14846 | Layer               |  | 0.35 |      | Natural. Filled by dark blackish brown silty sand with frequent gravels.  |  |  |
| 14847 | Unexcavated feature |  | 1.8  |      | Tree Throw. Filled by greyish brown sandy silt with no inclusions         |  |  |
| 14848 | Unexcavated feature |  | 0.5  |      | Posthole. Filled by dark blackish brown silty sand with frequent gravels. |  |  |

|       |                     |       |      |      |   |  |  |
|-------|---------------------|-------|------|------|---|--|--|
| 14849 | Unexcavated feature |       | 0.55 |      | Ditch. Possible ditch terminus  |  |  |
| 14850 | Unexcavated feature |       | 0.85 |      | Ditch. Possible ditch terminus  |  |  |
| 14851 | Fill                | 14843 | 0.3  | 0.09 | Secondary Fill. Dark blackish brown silty sand with frequent gravels. |  |  |
| 14852 | Fill                | 14838 | 0.3  | 0.09 | Secondary Fill. mid greyish brown silty sand                          |  |  |

### Trench 149

|  |  |  |  |  |                |  |         |
|--|--|--|--|--|----------------|--|---------|
| General description  |  |  |  |  | Orientation    |  | WNW-ESE |
| Trench has one linear and a posthole. Consists of ploughsoil overlying gravel natural. |  |  |  |  | Length (m)     |  | 30      |
|  |  |  |  |  | Width (m)      |  | 2       |
|  |  |  |  |  | Avg. depth (m) |  | 0.38    |

| Context No. | Type  | Fill Of | Width (m) | Depth (m) | Description   | Finds | Date |
|-------------|-------|---------|-----------|-----------|---|-------|------|
| 14900       | Layer |         |           | 0.3       | Ploughsoil. Orange grey sandy silt with frequent rounded pebbles  |       |      |
| 14901       | Layer |         |           |           | Natural. Light yellow-orange silty sand with frequent flint pebbles and gravels   |       |      |
| 14902       | Cut   |         | 0.91      | 0.25      | Ditch   |       |      |
| 14903       | Fill  | 14902   | 0.91      | 0.25      | Primary Fill. Dark brown Loam Abundant gravel   |       |      |
| 14904       | Cut   |         | 0.4       | 0.26      | Natural Feature. Cut for a natural feature. Continues beyond northern LOE of trench. Filled by yellow grey sandy clay with rare rounded pebble and gravel inclusions. |       |      |
| 14905       | Cut   |         | 0.3       | 0.18      | Posthole. Cut for a straight sided posthole   |       |      |
| 14906       | Fill  | 14905   | 0.3       | 0.18      | Primary Fill. Orange grey silty sand with rare rounded gravel inclusions  |       |      |
| 14907       | Cut   |         | 0.75      |           | Natural Feature. Change in natural investigated.  |       |      |
| 14908       | Cut   |         | 1.71      |           | Natural Feature. Two interventions dug in natural feature   |       |      |

| 14909  | Cut   |         | 0.92      |           | Natural Feature.<br>Natural feature that was investigated.                                   |       |       |
|--|-------|---------|-----------|-----------|--|-------|-------|
| <b>Trench 150</b>  |       |         |           |           |  |       |       |
| General description  |       |         |           |           | Orientation  |       | N-S   |
| Trench contains two linears. Consists of ploughsoil overlying gravel natural.      |       |         |           |           | Length (m)   |       | 30    |
|  |       |         |           |           | Width (m)  |       | 2     |
|  |       |         |           |           | Avg. depth (m)   |       | 0.4   |
| Context No.  | Type  | Fill Of | Width (m) | Depth (m) | Description  | Finds | Date  |
| 15000  | Layer |         |           | 0.4       | Ploughsoil. Dark orange-brown sandy silt with frequent rounded pebbles                       |       |       |
| 15001  | Layer |         |           |           | Natural. Light yellow-orange sandy gravels with frequent rounded pebbles                     |       |       |
| 15002  | Cut   |         | 0.84      | 0.32      | Ditch  |       |       |
| 15003  | Fill  | 15002   | 0.84      | 0.32      | Secondary Fill. Greyish brown, gravelly sandy silt, loose, occasional bioturbation           | Pot   | Roman |
| 15004  | Cut   |         | 0.76      | 0.3       | Ditch  |       |       |
| 15005  | Fill  | 15004   | 0.76      | 0.3       | Secondary Fill. Greyish brown, gravelly sandy silt frequent bioturbation and rounded pebbles |       |       |
| 15006  | Cut   |         | 1.35      | 0.16      | Ditch  |       |       |
| 15007  | Fill  | 15006   | 1.35      | 0.16      | Secondary Fill. Light greyish brown, sandy silt, loose, frequent rounded pebbles             | Pot   | Roman |
| <b>Trench 151</b>  |       |         |           |           |  |       |       |
| General description  |       |         |           |           | Orientation  |       | W-E   |
| Trench devoid of archaeology consists of plough soil overlying natural clayey sand |       |         |           |           | Length (m)   |       | 30    |
|  |       |         |           |           | Width (m)  |       | 2     |
|  |       |         |           |           | Avg. depth (m)   |       | 0.3   |
| Context No.  | Type  | Fill Of | Width (m) | Depth (m) | Description  | Finds | Date  |
| 15100  | Layer |         | 2         | 0.3       | Ploughsoil. Dark brown, silty sand, occasional rounded stones                                |       |       |
| 15101  | Layer |         | 2         |           | Natural. Reddish clayey sand,  |       |       |

|  |       |         |           |           | occasional rounded stones   |       |      |
|--|-------|---------|-----------|-----------|---|-------|------|
| <b>Trench 152</b>  |       |         |           |           |   |       |      |
| General description  |       |         |           |           | Orientation   |       | E-W  |
| Trench devoid of archaeology consists of plough soil overlying natural clayey sand |       |         |           |           | Length (m)  |       | 30   |
|  |       |         |           |           | Width (m)   |       | 2    |
|  |       |         |           |           | Avg. depth (m)  |       | 0.35 |
| Context No.  | Type  | Fill Of | Width (m) | Depth (m) | Description   | Finds | Date |
| 15200  | Layer |         | 2         | 0.34      | Ploughsoil. Dark brown, sandy silt, occasional rounded stones                     |       |      |
| 15201  | Layer |         | 2         |           | Natural. Reddish brown, clayey sand, rare rounded stones                          |       |      |
| 15202  | Void  |         |           |           |   |       |      |
| <b>Trench 153</b>  |       |         |           |           |   |       |      |
| General description  |       |         |           |           | Orientation   |       | N-S  |
| Trench devoid of archaeology consists of plough soil overlying natural clayey sand |       |         |           |           | Length (m)  |       | 30   |
|  |       |         |           |           | Width (m)   |       | 2    |
|  |       |         |           |           | Avg. depth (m)  |       | 0.4  |
| Context No.  | Type  | Fill Of | Width (m) | Depth (m) | Description   | Finds | Date |
| 15300  | Layer |         | 2         | 0.4       | Ploughsoil. Dark brown, silty sand  |       |      |
| 15301  | Layer |         | 2         |           | Natural. Reddish brown, clayey sand, occasional rounded stones                    |       |      |
| <b>Trench 154</b>  |       |         |           |           |   |       |      |
| General description  |       |         |           |           | Orientation   |       | E-W  |
| Trench devoid of archaeology consists of plough soil overlying natural clayey sand |       |         |           |           | Length (m)  |       | 30   |
|  |       |         |           |           | Width (m)   |       | 2    |
|  |       |         |           |           | Avg. depth (m)  |       | 0.3  |
| Context No.  | Type  | Fill Of | Width (m) | Depth (m) | Description   | Finds | Date |
| 15400  | Layer |         | 2         | 0.3       | Ploughsoil. Dark brown, silty sand, occasional rounded stones                     |       |      |
| 15401  | Layer |         | 2         |           | Natural. Reddish brown, clayey sand, occasional rounded stones and fine manganese |       |      |
| <b>Trench 155</b>  |       |         |           |           |   |       |      |

| General description  |       |         |           |           |  | Orientation    | NE-SW   |
|--|-------|---------|-----------|-----------|--|----------------|---------|
| Trench devoid of archaeology. Consists of ploughsoil overlying sandy clay natural. |       |         |           |           |  | Length (m)     | 30      |
|  |       |         |           |           |  | Width (m)      | 2       |
|  |       |         |           |           |  | Avg. depth (m) | 0.35    |
| Context No.  | Type  | Fill Of | Width (m) | Depth (m) | Description  | Finds          | Date    |
| 15500  | Layer |         |           | 0.35      | Ploughsoil. Greyish brown sandy silt                                 |                |         |
| 15501  | Layer |         |           |           | Natural. Orange-brown sandy clay                                     |                |         |
| <b>Trench 156</b>  |       |         |           |           |  |                |         |
| General description  |       |         |           |           |  | Orientation    | NW-SE   |
| Trench contains one pit. Consists of ploughsoil overlying sandy clay natural.      |       |         |           |           |  | Length (m)     | 30      |
|  |       |         |           |           |  | Width (m)      | 2       |
|  |       |         |           |           |  | Avg. depth (m) | 0.42    |
| Context No.  | Type  | Fill Of | Width (m) | Depth (m) | Description  | Finds          | Date    |
| 15600  | Layer |         |           | 0.42      | Ploughsoil. Greyish brown sandy silt                                 |                |         |
| 15601  | Layer |         |           |           | Natural. Light reddish brown silty clay with rare pebble inclusions. |                |         |
| 15602  | Cut   |         | 0.37      | 0.2       | Pit  |                |         |
| 15603  | Fill  | 15602   | 0.37      | 0.2       | Secondary Fill. Dark brown-grey, sandy clay, firm                    |                |         |
| <b>Trench 157</b>  |       |         |           |           |  |                |         |
| General description  |       |         |           |           |  | Orientation    | ENE-WSW |
| Trench devoid of archaeology. Consists of ploughsoil overlying silty clay natural. |       |         |           |           |  | Length (m)     | 30      |
|  |       |         |           |           |  | Width (m)      | 2       |
|  |       |         |           |           |  | Avg. depth (m) | 0.45    |
| Context No.  | Type  | Fill Of | Width (m) | Depth (m) | Description  | Finds          | Date    |
| 15700  | Layer |         |           | 0.45      | Ploughsoil. Grey-brown sandy silt with rare gravel inclusions.       |                |         |
| 15701  | Layer |         |           |           | Natural. Light orange-brown silty clay with occasional gravels.      |                |         |
| <b>Trench 160</b>  |       |         |           |           |  |                |         |
| General description  |       |         |           |           |  | Orientation    | E-W     |
| Trench devoid of archaeology consists of plough soil overlying natural clayey sand |       |         |           |           |  | Length (m)     | 30      |
|  |       |         |           |           |  | Width (m)      | 2       |
|  |       |         |           |           |  | Avg. depth (m) | 0.35    |

| Context No. | Type  | Fill Of | Width (m) | Depth (m) | Description  | Finds | Date |
|-------------|-------|---------|-----------|-----------|--|-------|------|
| 16000       | Layer |         | 1         | 0.35      | Ploughsoil. Dark brown, silty sand, occasional rounded stones                        |       |      |
| 16001       | Layer |         | 2         |           | Natural. Reddish brown, clayey sand, rare rounded stones and frequent fine manganese |       |      |

#### Trench 161

|  |                |      |
|--|----------------|------|
| General description  | Orientation    | N-S  |
| Trench devoid of archaeology consists of plough soil overlying natural clayey sand | Length (m)     | 30   |
|  | Width (m)      | 2    |
|  | Avg. depth (m) | 0.35 |

| Context No. | Type  | Fill Of | Width (m) | Depth (m) | Description  | Finds | Date |
|-------------|-------|---------|-----------|-----------|--|-------|------|
| 16100       | Layer |         | 2         | 0.35      | Ploughsoil. Dark brown, silty sand, occasional rounded pebbles |       |      |
| 16101       | Layer |         | 2         |           | Natural. Reddish brown, clayey sand, rare rounded stones       |       |      |

#### Trench 164

|  |                |     |
|--|----------------|-----|
| General description  | Orientation    | E-W |
| Trench devoid of archaeology consists of plough soil and colluvium? Overlying silty sand natural | Length (m)     | 30  |
|  | Width (m)      | 2   |
|  | Avg. depth (m) | 0.6 |

| Context No. | Type  | Fill Of | Width (m) | Depth (m) | Description   | Finds | Date |
|-------------|-------|---------|-----------|-----------|---|-------|------|
| 16400       | Layer |         | 2         | 0.2       | Ploughsoil. Dark brown, silty sand, occasional rounded stones         |       |      |
| 16401       | Layer |         | 2         | 0.4       | Colluvial Layer. Brown, silty sand, occasional rounded stones         |       |      |
| 16402       | Layer |         | 2         |           | Natural. Light yellowish brown, sandy silt, occasional rounded stones |       |      |

#### Trench 165

|  |             |       |
|--|-------------|-------|
| General description  | Orientation | NE-SW |
| Trench contains one ditch. Consists of ploughsoil overlaying gravelled natural | Length (m)  | 30    |
|  | Width (m)   | 2.1   |

|             |       |         |           |           | Avg. depth (m)   | 0.4   |      |
|-------------|-------|---------|-----------|-----------|--|-------|------|
| Context No. | Type  | Fill Of | Width (m) | Depth (m) | Description  | Finds | Date |
| 16500       | Layer |         | 2.1       | 0.4       | Ploughsoil. Grey-brown, silty sand, loose. With rounded stone and potatoes |       |      |
| 16501       | Cut   |         | 0.59      | 0.05      | Ditch. Shallow ditch   |       |      |
| 16502       | Fill  | 16501   | 0.59      | 0.05      | Secondary Fill. Grey silty sand  |       |      |
| 16503       | Layer |         |           |           | Natural. Light brownish yellow silty sand with occasional gravel patches.  |       |      |

### Trench 166

|   |  |  |  |  |                |  |     |
|---|--|--|--|--|----------------|--|-----|
| General description   |  |  |  |  | Orientation    |  | E-W |
| Trench devoid of archaeology consists of plough soil overlying natural silty sand |  |  |  |  | Length (m)     |  | 30  |
|   |  |  |  |  | Width (m)      |  | 2   |
|   |  |  |  |  | Avg. depth (m) |  | 0.4 |

| Context No. | Type  | Fill Of | Width (m) | Depth (m) | Description   | Finds | Date |
|-------------|-------|---------|-----------|-----------|---|-------|------|
| 16600       | Layer |         | 2         | 0.4       | Ploughsoil. Dark brown Silty Sand, occasional rounded stones                |       |      |
| 16601       | Layer |         | 2         |           | Natural. Light yellowish brown with occasional rounded pebbles and hematite |       |      |

### Trench 167

|   |  |  |  |  |                |  |       |
|---|--|--|--|--|----------------|--|-------|
| General description   |  |  |  |  | Orientation    |  | NE-SW |
| Trench devoid of archaeology. Consists of ploughsoil overlying sandy natural. |  |  |  |  | Length (m)     |  | 30    |
|   |  |  |  |  | Width (m)      |  | 2     |
|   |  |  |  |  | Avg. depth (m) |  | 0.4   |

| Context No. | Type  | Fill Of | Width (m) | Depth (m) | Description   | Finds | Date |
|-------------|-------|---------|-----------|-----------|---|-------|------|
| 16700       | Layer |         |           | 0.4       | Ploughsoil. Grey-brown silty sand, loose with rounded stones  |       |      |
| 16701       | Layer |         |           |           | Natural. Light brownish yellow silty sand with gravel patches |       |      |

### Trench 168

|                     |  |  |  |  |             |  |     |
|---------------------|--|--|--|--|-------------|--|-----|
| General description |  |  |  |  | Orientation |  | N-S |
|                     |  |  |  |  | Length (m)  |  | 30  |



| Trench devoid of archaeology consists of plough soil and subsoil overlying natural sandy silt and gravel |       |         |           |           | Width (m)   | 2     |      |
|--|-------|---------|-----------|-----------|---|-------|------|
|  |       |         |           |           | Avg. depth (m)  | 0.4   |      |
| Context No.  | Type  | Fill Of | Width (m) | Depth (m) | Description   | Finds | Date |
| 16800  | Layer |         | 2         | 0.3       | Ploughsoil. Dark brown, silty sand occasional rounded stones                      |       |      |
| 16801  | Layer |         | 2         | 0.1       | Subsoil. Greyish brown, silty sand occasional rounded stones                      |       |      |
| 16802  | Layer |         | 2         |           | Natural. Light grey and brown silty sand and gravel                               |       |      |
| <b>Trench 169</b>  |       |         |           |           |   |       |      |
| General description  |       |         |           |           | Orientation   | E-W   |      |
| Trench contains one linear. Consists of ploughsoil overlying sand natural.                               |       |         |           |           | Length (m)  | 30    |      |
|  |       |         |           |           | Width (m)   | 2     |      |
|  |       |         |           |           | Avg. depth (m)  | 0.4   |      |
| Context No.  | Type  | Fill Of | Width (m) | Depth (m) | Description   | Finds | Date |
| 16900  | Layer |         |           | 0.4       | Ploughsoil. Greyish brown sandy silt with occasional rounded pebbles.             |       |      |
| 16901  | Layer |         |           |           | Natural. Light yellow-orange sand with occasional gravels                         |       |      |
| 16902  | Cut   |         | 1.26      | 0.28      | Ditch   |       |      |
| 16903  | Fill  | 16902   | 1.26      | 0.28      | Primary Fill. Grey-brown, sandy silt, frequent small rounded stone incl, no finds |       |      |
| 16904  | Cut   |         |           |           | Natural Feature   |       |      |
| <b>Trench 170</b>  |       |         |           |           |   |       |      |
| General description  |       |         |           |           | Orientation   | E-W   |      |
| Trench contains one ditch. Consists of ploughsoil and subsoil overlying sandy natural.                   |       |         |           |           | Length (m)  | 30    |      |
|  |       |         |           |           | Width (m)   | 2     |      |
|  |       |         |           |           | Avg. depth (m)  | 0.4   |      |
| Context No.  | Type  | Fill Of | Width (m) | Depth (m) | Description   | Finds | Date |
| 17000  | Layer |         |           | 0.26      | Ploughsoil. Dark greyish brown silty sand with rare pebble inclusions             |       |      |
| 17001  | Layer |         |           | 0.14      | Subsoil. Greyish brown, soft, silty sand  |       |      |
| 17002  | Layer |         |           |           | Natural. Light yellowish brown,   |       |      |

|  |                     |         |           |           | loose, silty sand, occasional gravel patches                   |                  |                  |
|--|---------------------|---------|-----------|-----------|--|------------------|------------------|
| 17003  | Cut                 |         | 1.25      | 0.32      | Ditch. N-S ditch   |                  |                  |
| 17004  | Fill                | 17003   | 1.25      | 0.32      | Secondary Fill. Soft greyish brown sandy silt                  |                  |                  |
| <b>Trench 171</b>  |                     |         |           |           |  |                  |                  |
| General description  |                     |         |           |           | Orientation  |                  | E-W              |
| Trench devoid of archaeology consists of plough soil overlying natural silty sand.                                 |                     |         |           |           | Length (m)   |                  | 30               |
|  |                     |         |           |           | Width (m)  |                  | 2                |
|  |                     |         |           |           | Avg. depth (m)   |                  | 0.35             |
| Context No.  | Type                | Fill Of | Width (m) | Depth (m) | Description  | Finds            | Date             |
| 17100  | Layer               |         | 2         | 0.35      | Ploughsoil. Dark brown, silty sand, occasional rounded pebbles |                  |                  |
| 17101  | Layer               |         | 2         |           | Natural. Yellowish brown, silty sand frequent gravel patches   |                  |                  |
| <b>Trench 172</b>  |                     |         |           |           |  |                  |                  |
| General description  |                     |         |           |           | Orientation  |                  | NW-SE            |
| Trench contains four ditches and two possible postholes. Consists of ploughsoil overlaying natural geology of sand |                     |         |           |           | Length (m)   |                  | 30               |
|  |                     |         |           |           | Width (m)  |                  | 2                |
|  |                     |         |           |           | Avg. depth (m)   |                  | 0.37             |
| Context No.  | Type                | Fill Of | Width (m) | Depth (m) | Description  | Finds            | Date             |
| 17200  | Layer               |         |           | 0.36      | Ploughsoil. Dark grey-brown, silty clay, firm                  |                  |                  |
| 17201  | Layer               |         |           |           | Natural. Grey-yellow, silty sand, friable                      |                  |                  |
| 17202  | Cut                 |         | 2.1       | 0.4       | Ditch  |                  |                  |
| 17203  | Fill                | 17202   | 1.4       | 0.34      | Secondary Fill. Grey-brown, silty sand, loose                  |                  |                  |
| 17204  | Cut                 |         | 0.76      | 0.46      | Ditch  |                  |                  |
| 17205  | Fill                | 17204   | 0.76      | 0.46      | Deliberate Backfill. Dark brown-grey, silty sand, loose        | Pot, animal bone | AD 140–240       |
| 17206  | Cut                 |         | 1.38      | 0.34      | Ditch  |                  |                  |
| 17207  | Fill                | 17206   | 1.38      | 0.34      | Secondary Fill. Mid grey-brown, silty sand, loose              |                  |                  |
| 17208  | Cut                 |         | 2.2       | 0.4       | Ditch  |                  |                  |
| 17209  | Fill                | 17208   | 2.2       | 0.4       | Secondary Fill. Dark grey-brown, silty sand, loose             | CBM, Fe          | C16–18, PMed/Mod |
| 17210  | Unexcavated feature |         |           | 0.27      | Posthole. Circular in plan. Grey-                              |                  |                  |

|   |                     |         |           |           | brown, silty sand, loose  |       |       |
|---|---------------------|---------|-----------|-----------|---|-------|-------|
| 17211   | Unexcavated feature |         |           | 0.24      | Posthole. Circular in plan. Grey-brown, silty sand, loose   |       |       |
| <b>Trench 173</b>   |                     |         |           |           |   |       |       |
| General description   |                     |         |           |           | Orientation   |       | NW-SE |
| Trench contains one large probable natural feature which was not bottomed. Consists of ploughsoil overlaying natural clayey sand. |                     |         |           |           | Length (m)  |       | 30    |
|   |                     |         |           |           | Width (m)   |       | 2.1   |
|   |                     |         |           |           | Avg. depth (m)  |       | 0.4   |
| Context No.   | Type                | Fill Of | Width (m) | Depth (m) | Description   | Finds | Date  |
| 17300   | Layer               |         | 2.1       | 0.4       | Ploughsoil. Grey-brown, silty sand, friable with rooting potatoes and rounded stone   |       |       |
| 17301   | Layer               |         | 2.1       |           | Natural. Light whiteish yellow with orange patches, silty sand, with gravel inclusions  |       |       |
| 17302   | Layer               |         |           |           | Colluvial Layer. Large natural feature across most of the base of the trench, grey sandy silt with occasional angular flint inclusions. |       |       |
| <b>Trench 174</b>   |                     |         |           |           |   |       |       |
| General description   |                     |         |           |           | Orientation   |       | NE-SW |
| Trench contains one ditch and one unexcavated feature. Consists of ploughsoil overlying sandy natural.                            |                     |         |           |           | Length (m)  |       | 30    |
|   |                     |         |           |           | Width (m)   |       | 2     |
|   |                     |         |           |           | Avg. depth (m)  |       | 0.4   |
| Context No.   | Type                | Fill Of | Width (m) | Depth (m) | Description   | Finds | Date  |
| 17400   | Layer               |         |           | 0.4       | Ploughsoil. Dark brown, silty sand, occasional rounded stones   |       |       |
| 17401   | Layer               |         |           |           | Natural. Yellowish brown, silty sand frequent gravel patches  |       |       |
| 17402   | Cut                 |         | 1.9       | 0.34      | Ditch. E-W  |       |       |
| 17403   | Fill                | 17402   | 1.9       | 0.34      | Secondary Fill. Loose, yellowish brown silty sand   |       |       |
| 17404   | Unexcavated feature |         | 1.35      |           | Other Cut. Brown silty sand. Possible ditch if not a  |       |       |

|   |       |         |           |           | spread of residual ploughsoil.   |            |        |
|---|-------|---------|-----------|-----------|--|------------|--------|
| <b>Trench 175</b>   |       |         |           |           |  |            |        |
| General description   |       |         |           |           | Orientation  |            | N-S    |
| Trench devoid of archaeology consists of plough soil overlying natural silty sand     |       |         |           |           | Length (m)   |            | 30     |
|   |       |         |           |           | Width (m)  |            | 2      |
|   |       |         |           |           | Avg. depth (m)   |            | 0.35   |
| Context No.   | Type  | Fill Of | Width (m) | Depth (m) | Description  | Finds      | Date   |
| 17500   | Layer |         | 2         | 0.35      | Ploughsoil. Dark brown, silty sand, occasional rounded stones                                      |            |        |
| 17501   | Layer |         | 2         |           | Natural. Light yellowish brown, loose, silty sand, occasional gravel patches and frequent hematite |            |        |
| <b>Trench 176</b>   |       |         |           |           |  |            |        |
| General description   |       |         |           |           | Orientation  |            | NW-SE  |
| Trench contains one ditch. Consists of ploughsoil and subsoil overlying natural sand. |       |         |           |           | Length (m)   |            | 30     |
|   |       |         |           |           | Width (m)  |            | 2.1    |
|   |       |         |           |           | Avg. depth (m)   |            | 0.4    |
| Context No.   | Type  | Fill Of | Width (m) | Depth (m) | Description  | Finds      | Date   |
| 17600   | Layer |         | 2.1       | 0.3       | Ploughsoil   |            |        |
| 17601   | Layer |         | 2.1       | 0.23      | Subsoil. Orangish brown silty sand, friable  |            |        |
| 17602   | Layer |         |           |           | Natural. Light whiteish yellow, silty sand, with gravel inclusions                                 |            |        |
| 17603   | Cut   |         | 1.54      | 0.14      | Ditch. E-W shallow ditch.  |            |        |
| 17604   | Fill  | 17603   | 1.54      | 0.14      | Secondary Fill. Dark brown sandy silt with occasional charcoal                                     | Pot, flint | MBA-IA |
| <b>Trench 177</b>   |       |         |           |           |  |            |        |
| General description   |       |         |           |           | Orientation  |            | NE-SW  |
| Trench contains one linear. Consists of ploughsoil overlying sandy natural.           |       |         |           |           | Length (m)   |            | 30     |
|   |       |         |           |           | Width (m)  |            | 2      |
|   |       |         |           |           | Avg. depth (m)   |            | 0.48   |
| Context No.   | Type  | Fill Of | Width (m) | Depth (m) | Description  | Finds      | Date   |
| 17700   | Layer |         |           | 0.4       | Ploughsoil. Greyish brown sandy silt.  |            |        |
| 17701   | Layer |         |           |           | Natural. Light orange yellow with  |            |        |

|   |                     |         |           |           | occasional gravel patches.   |       |         |
|---|---------------------|---------|-----------|-----------|--|-------|---------|
| 17702   | Cut                 |         | 1.58      | 0.32      | Ditch  |       |         |
| 17703   | Fill                | 17702   | 1.58      | 0.32      | Secondary Fill. Brown silty sand.  |       |         |
| <b>Trench 178</b>   |                     |         |           |           |  |       |         |
| General description   |                     |         |           |           | Orientation  |       | NE-SW   |
| Trench devoid of archaeology. Consists of ploughsoil overlying sandy natural. |                     |         |           |           | Length (m)   |       | 1.8     |
|   |                     |         |           |           | Width (m)  |       | 2       |
|   |                     |         |           |           | Avg. depth (m)   |       | 0.4     |
| Context No.   | Type                | Fill Of | Width (m) | Depth (m) | Description  | Finds | Date    |
| 17800   | Layer               |         |           | 0.4       | Ploughsoil. Dark greyish brown silty sand with occasional rounded pebbles.             |       |         |
| 17801   | Layer               |         |           |           | Natural. Light yellow-orange sand with occasional patches of gravel.                   |       |         |
| <b>Trench 179</b>   |                     |         |           |           |  |       |         |
| General description   |                     |         |           |           | Orientation  |       | ENE-WSW |
| Trench has one linear. Consists of ploughsoil overlying sand natural.         |                     |         |           |           | Length (m)   |       | 30      |
|   |                     |         |           |           | Width (m)  |       | 2       |
|   |                     |         |           |           | Avg. depth (m)   |       | 0.42    |
| Context No.   | Type                | Fill Of | Width (m) | Depth (m) | Description  | Finds | Date    |
| 17900   | Layer               |         |           | 0.35      | Ploughsoil. Dark grey-brown silty sand with occasional flint pebbles.                  |       |         |
| 17901   | Layer               |         |           |           | Natural. Light orange sand with occasional patches of gravel                           |       |         |
| 17902   | Cut                 |         | 0.6       | 0.26      | Ditch  |       |         |
| 17903   | Fill                | 17902   | 0.7       | 0.26      | Primary Fill. Grey-brown, silty loam. Some stone inclusions. Slag in fill. Single fill |       |         |
| 17904   | Unexcavated feature |         |           |           | Ditch. Ditch terminus, possible curvilinear. Fill silty loam, grey-brown.              |       |         |
| <b>Trench 180</b>   |                     |         |           |           |  |       |         |
| General description   |                     |         |           |           | Orientation  |       | NNW-SSE |
|   |                     |         |           |           | Length (m)   |       | 30      |

| Trench devoid of archaeology. Consists of ploughsoil overlying sand natural.                     |       |         |           |           | Width (m)   | 2     |          |
|--|-------|---------|-----------|-----------|---|-------|----------|
|  |       |         |           |           | Avg. depth (m)  | 0.45  |          |
| Context No.  | Type  | Fill Of | Width (m) | Depth (m) | Description   | Finds | Date     |
| 18000  | Layer |         |           | 0.35      | Ploughsoil. Dark greyish brown silty sand with rare pebble inclusions               |       |          |
| 18001  | Layer |         |           |           | Natural. Soft light yellow-orange sand with occasional patches of gravel.           |       |          |
| <b>Trench 181</b>  |       |         |           |           |   |       |          |
| General description  |       |         |           |           | Orientation   | NW-SE |          |
| Trench devoid of archaeology. Consists of ploughsoil overlying a sandy gravelled natural         |       |         |           |           | Length (m)  | 30    |          |
|  |       |         |           |           | Width (m)   | 2.1   |          |
|  |       |         |           |           | Avg. depth (m)  | 0.36  |          |
| Context No.  | Type  | Fill Of | Width (m) | Depth (m) | Description   | Finds | Date     |
| 18100  | Layer |         |           | 0.36      | Ploughsoil. Grey-brown, silty sand, friable with rooting potatoes and rounded stone |       |          |
| 18101  | Layer |         |           |           | Natural. Light whiteish yellow, silty sand, with gravel inclusions                  |       |          |
| <b>Trench 182</b>  |       |         |           |           |   |       |          |
| General description  |       |         |           |           | Orientation   | NE-SW |          |
| Trench devoid of archaeology. Consists of ploughsoil overlying natural                           |       |         |           |           | Length (m)  | 30    |          |
|  |       |         |           |           | Width (m)   |       |          |
|  |       |         |           |           | Avg. depth (m)  | 0.4   |          |
| Context No.  | Type  | Fill Of | Width (m) | Depth (m) | Description   | Finds | Date     |
| 18200  | Layer |         |           | 0.4       | Ploughsoil. Grey-brown silty sand, friable with rounded stones                      | Flint | PH (res) |
| 18201  | Layer |         |           |           | Natural. Light whiteish yellow, silty sand, with gravel inclusions                  |       |          |
| <b>Trench 183</b>  |       |         |           |           |   |       |          |
| General description  |       |         |           |           | Orientation   | NW-SE |          |
| Trench contains two ditches, one pit and one posthole. Consists of ploughsoil overlying natural. |       |         |           |           | Length (m)  | 30    |          |
|  |       |         |           |           | Width (m)   | 2.1   |          |
|  |       |         |           |           | Avg. depth (m)  | 0.36  |          |
| Context No.  | Type  | Fill Of | Width (m) | Depth (m) | Description   | Finds | Date     |

|       |       |       |      |      |   |  |  |
|-------|-------|-------|------|------|---|--|--|
| 18300 | Layer |       |      | 0.3  | Ploughsoil. Grey-brown, silty sand, friable with rooting potatoes and rounded stone |  |  |
| 18301 | Layer |       |      |      | Natural. Light whiteish yellow, silty sand, with gravel inclusions                  |  |  |
| 18302 | Cut   |       | 0.45 | 0.3  | Pit. Small pit cut by [18304]   |  |  |
| 18303 | Fill  | 18302 | 0.45 | 0.3  | Secondary Fill. Brownish grey. Sandy silt. Soft. Rare pebble inclusions             |  |  |
| 18304 | Cut   |       | 1.5  | 0.5  | Ditch   |  |  |
| 18305 | Cut   |       | 0.26 | 0.15 | Posthole  |  |  |
| 18306 | Fill  | 18304 | 0.45 | 0.2  | Secondary Fill. Blackish brown. Soft sandy silt.                                    |  |  |
| 18307 | Fill  | 18304 | 1.5  | 0.5  | Secondary Fill. Greyish brow. Sandy silt. Soft.                                     |  |  |
| 18308 | Fill  | 18305 | 0.25 | 0.15 | Secondary Fill. Orange-brown sandy silt. Soft.                                      |  |  |
| 18309 | Cut   |       | 1.75 | 0.18 | Ditch. Possible modern feature  |  |  |
| 18310 | Fill  | 18309 | 1.57 | 0.18 | Secondary Fill. Greyish brown, loose, sandy silt                                    |  |  |

#### Trench 184

|  |  |                |       |
|--|--|----------------|-------|
| General description  |  | Orientation    | NE-SW |
| Trench contains one ditch. Consists of ploughsoil overlaying natural geology of silty sand with gravel |  | Length (m)     | 30    |
|  |  | Width (m)      | 2.1   |
|  |  | Avg. depth (m) | 0.33  |

| Context No. | Type  | Fill Of | Width (m) | Depth (m) | Description   | Finds           | Date   |
|-------------|-------|---------|-----------|-----------|---|-----------------|--------|
| 18400       | Layer |         | 2.1       | 0.33      | Ploughsoil. Grey-brown, silty sand, friable with rooting potatoes and rounded stone |                 |        |
| 18401       | Layer |         |           |           | Natural. Light whiteish yellow, silty sand, with gravel inclusions                  |                 |        |
| 18402       | Cut   |         | 1.42      | 0.38      | Ditch   |                 |        |
| 18403       | Fill  | 18402   | 0.76      | 0.14      | Secondary Fill. Light brown-grey, silty sand, loose                                 | Pot, fired clay | LBA/IA |
| 18404       | Fill  | 18402   | 1.42      | 0.24      | Secondary Fill. Dark grey-brown, silty sand, loose                                  |                 |        |

| <b>Trench 185</b>  |       |         |           |           |   |                  |        |
|--|-------|---------|-----------|-----------|---|------------------|--------|
| General description  |       |         |           |           | Orientation   |                  | NW-SE  |
| Trench devoid of archaeology. Consists of ploughsoil overlaying silty gravelled natural          |       |         |           |           | Length (m)  |                  | 30     |
|  |       |         |           |           | Width (m)   |                  | 2.1    |
|  |       |         |           |           | Avg. depth (m)  |                  | 0.3    |
| Context No.  | Type  | Fill Of | Width (m) | Depth (m) | Description   | Finds            | Date   |
| 18500  | Layer |         | 2.1       | 0.3       | Ploughsoil. Grey-brown, silty sand, friable with rooting potatoes and rounded stone |                  |        |
| 18501  | Layer |         |           |           | Natural. Orangish yellow, silty sand, with gravel inclusions                        |                  |        |
| <b>Trench 186</b>  |       |         |           |           |   |                  |        |
| General description  |       |         |           |           | Orientation   |                  | NW-SE  |
| Trench contains three ditches. Consists of ploughsoil overlaying sandy gravelled natural         |       |         |           |           | Length (m)  |                  | 30     |
|  |       |         |           |           | Width (m)   |                  | 2.1    |
|  |       |         |           |           | Avg. depth (m)  |                  | 0.3    |
| Context No.  | Type  | Fill Of | Width (m) | Depth (m) | Description   | Finds            | Date   |
| 18600  | Layer |         |           | 0.3       | Ploughsoil. Grey-brown, silty sand, friable with rooting potatoes and rounded stone |                  |        |
| 18601  | Layer |         |           |           | Natural. Light whiteish yellow, silty sand, with gravel inclusions                  |                  |        |
| 18602  | Cut   |         | 1.2       | 0.22      | Ditch   |                  |        |
| 18603  | Fill  | 18602   | 1.2       | 0.22      | Primary Fill. Dark grey-brown, silty loam, frequent stone inclusions                | Pot              | Roman? |
| 18604  | Cut   |         | 1.2       | 0.2       | Ditch   |                  |        |
| 18605  | Fill  | 18604   | 1.2       | 0.2       | Primary Fill. Dark grey-brown, silty loam, frequent stone inclusions                |                  |        |
| 18606  | Cut   |         | 2         | 0.58      | Ditch   |                  |        |
| 18607  | Fill  | 18606   | 2         | 0.58      | Primary Fill. Dark grey-brown, silty loam, frequent stone incl                      | CBM, animal bone | C14-16 |
| <b>Trench 187</b>  |       |         |           |           |   |                  |        |
| General description  |       |         |           |           | Orientation   |                  | E-W    |
| Trench contains one ditch. Consists of ploughsoil overlaying a sand natural with frequent gravel |       |         |           |           | Length (m)  |                  | 30     |
|  |       |         |           |           | Width (m)   |                  | 2.1    |
|  |       |         |           |           | Avg. depth (m)  |                  | 0.33   |



| Context No. | Type  | Fill Of | Width (m) | Depth (m) | Description  | Finds | Date |
|-------------|-------|---------|-----------|-----------|--|-------|------|
| 18700       | Layer |         |           | 0.37      | Ploughsoil. Grey-brown, silty sand, friable                        |       |      |
| 18701       | Layer |         |           |           | Natural. Light whiteish yellow, silty sand, with gravel inclusions |       |      |
| 18702       | Cut   |         | 0.96      | 0.22      | Ditch  |       |      |
| 18703       | Fill  | 18702   | 0.96      | 0.22      | Secondary Fill. Dark grey-brown, silty sand, loose                 |       |      |

### Trench 188

|   |  |  |  |  |                |  |      |
|---|--|--|--|--|----------------|--|------|
| General description   |  |  |  |  | Orientation    |  | E-W  |
| Consists of ploughsoil overlaying a sandy gravelled natural |  |  |  |  | Length (m)     |  | 30   |
|   |  |  |  |  | Width (m)      |  | 2.1  |
|   |  |  |  |  | Avg. depth (m) |  | 0.32 |

| Context No. | Type  | Fill Of | Width (m) | Depth (m) | Description  | Finds | Date |
|-------------|-------|---------|-----------|-----------|--|-------|------|
| 18800       | Layer |         |           | 0.39      | Ploughsoil. Grey-brown, silty sand, friable                        |       |      |
| 18801       | Layer |         |           |           | Natural. Light whiteish yellow, silty sand, with gravel inclusions |       |      |
| 18802       | Cut   |         | 0.6       | 0.05      | Pit  |       |      |
| 18803       | Fill  | 18802   | 0.6       | 0.05      | Secondary Fill. loose dark grey sandy silt                         |       |      |
| 18804       | Cut   |         | 0.88      | 0.13      | Pit  |       |      |
| 18805       | Fill  | 18804   | 0.88      | 0.13      | Secondary Fill. Loose, dark blackish grey sandy silt               |       |      |

### Trench 189

|   |  |  |  |  |                |  |     |
|---|--|--|--|--|----------------|--|-----|
| General description   |  |  |  |  | Orientation    |  | E-W |
| Trench contains one ditch and two pits. Consists of ploughsoil and subsoil overlaying natural geology of silty sand with gravel |  |  |  |  | Length (m)     |  | 30  |
|   |  |  |  |  | Width (m)      |  | 2.1 |
|   |  |  |  |  | Avg. depth (m) |  | 0.4 |

| Context No. | Type  | Fill Of | Width (m) | Depth (m) | Description                                      | Finds | Date |
|-------------|-------|---------|-----------|-----------|--|-------|------|
| 18900       | Layer |         |           | 0.26      | Ploughsoil. Dark grey-brown, silty sand, friable |       |      |
| 18901       | Layer |         |           | 0.15      | Subsoil. Grey-brown, silty sand, friable         |       |      |
| 18902       | Layer |         |           |           | Natural. Grey-brown, silty sand, loose           |       |      |
| 18903       | Cut   |         | 1.12      | 0.26      | Ditch  |       |      |

|       |      |       |      |      |  |  |  |
|-------|------|-------|------|------|--|--|--|
| 18904 | Fill | 18903 | 1.12 | 0.26 | Secondary Fill.<br>Dark brown-grey,<br>silty sand, loose |  |  |
| 18905 | Cut  |       | 0.45 | 0.14 | Pit  |  |  |
| 18906 | Fill | 18905 | 0.45 | 0.14 | Secondary Fill.<br>Dark grey-brown,<br>silty sand, loose |  |  |
| 18907 | Cut  |       | 0.44 | 0.15 | Pit  |  |  |
| 18908 | Fill | 18907 | 0.44 | 0.15 | Secondary Fill.<br>Dark grey-brown,<br>silty sand, loose |  |  |

### Trench 190

| General description  |       |         |           |           | Orientation   | NE-SW |      |
|--|-------|---------|-----------|-----------|---|-------|------|
| Trench devoid of archaeology. Consists of ploughsoil overlaying silty clayey gravelled natural |       |         |           |           | Length (m)  | 30    |      |
|  |       |         |           |           | Width (m)   | 2.1   |      |
|  |       |         |           |           | Avg. depth (m)  | 0.29  |      |
| Context No.  | Type  | Fill Of | Width (m) | Depth (m) | Description   | Finds | Date |
| 19000  | Layer |         |           | 0.4       | Ploughsoil. Grey-brown, silty sand, friable                                       |       |      |
| 19001  | Layer |         |           |           | Natural. Light orange yellow, silty sand, with clay patches and gravel inclusions |       |      |

### Trench 191

| General description   |       |         |           |           | Orientation  | NW-SE |      |
|---|-------|---------|-----------|-----------|--|-------|------|
| Trench devoid of archaeology. Consists of ploughsoil overlaying a silty gravelled natural |       |         |           |           | Length (m)   | 30    |      |
|   |       |         |           |           | Width (m)  | 2.2   |      |
|   |       |         |           |           | Avg. depth (m)   | 0.3   |      |
| Context No.   | Type  | Fill Of | Width (m) | Depth (m) | Description  | Finds | Date |
| 19100   | Layer |         | 2.1       | 0.3       | Ploughsoil. Grey-brown silty sand, friable with rounded stone and potatoes present |       |      |
| 19101   | Layer |         | 2.1       |           | Natural. Brownish orange, silty sand with gravel throughout, compact               |       |      |

### Trench 192

| General description  |      |         |           |           | Orientation    | NE-SW |      |
|--|------|---------|-----------|-----------|----------------|-------|------|
| Trench contains one ditch. Consists of ploughsoil overlaying a silty gravelled natural |      |         |           |           | Length (m)     | 30    |      |
|  |      |         |           |           | Width (m)      | 2.1   |      |
|  |      |         |           |           | Avg. depth (m) | 0.4   |      |
| Context No.  | Type | Fill Of | Width (m) | Depth (m) | Description    | Finds | Date |

|       |       |       |      |      |  |                |        |
|-------|-------|-------|------|------|--|----------------|--------|
| 19200 | Layer |       |      | 0.4  | Ploughsoil. Grey-brown, silty sand, friable with rounded pebbles   |                |        |
| 19201 | Layer |       | 2.1  |      | Natural. Brownish orange silty sand with gravel throughout. Firm   |                |        |
| 19202 | Cut   |       | 0.88 | 0.15 | Ditch. Boundary seen on historic map   |                |        |
| 19203 | Fill  | 19202 | 0.88 | 0.15 | Secondary Fill. Dark brownish grey silty sand with occasional rounded pebbles, moderate charcoal fragments | Pot, Fe, glass | C19-20 |

### Trench 194

| General description   |       |         |           |           | Orientation   | E-W   |      |
|---|-------|---------|-----------|-----------|---|-------|------|
| Trench devoid of archaeology. Consisted of ploughsoil and subsoil overlaying the natural geology of light yellow silty sand including patches of brown red silty gravel mix |       |         |           |           | Length (m)  | 30    |      |
|   |       |         |           |           | Width (m)   | 2     |      |
|   |       |         |           |           | Avg. depth (m)  | 0.6   |      |
| Context No.   | Type  | Fill Of | Width (m) | Depth (m) | Description   | Finds | Date |
| 19400   | Layer |         |           | 0.37      | Ploughsoil. Dark brown grey silty sand                                      |       |      |
| 19401   | Layer |         |           | 0.23      | Subsoil. medium brown red sandy silt  |       |      |
| 19402   | Layer |         |           |           | Natural. Brown red silty gravel patches intermixed with yellow sand patches |       |      |
| 19403   | Void  |         |           |           |   |       |      |

### Trench 195

| General description  |       |         |           |           | Orientation                          | E-W   |      |
|--|-------|---------|-----------|-----------|--------------------------------------|-------|------|
| Trench revealed two ditches. Trench consists of ploughsoil overlying a gravelly sand natural |       |         |           |           | Length (m)                           | 30    |      |
|  |       |         |           |           | Width (m)                            | 2     |      |
|  |       |         |           |           | Avg. depth (m)                       | 0.45  |      |
| Context No.  | Type  | Fill Of | Width (m) | Depth (m) | Description                          | Finds | Date |
| 19500  | Layer |         |           | 0.37      | Ploughsoil. Dark grey clayey silt    |       |      |
| 19501  | Layer |         |           |           | Natural. Reddish brown gravelly sand |       |      |
| 19502  | Cut   |         | 1.15      | 0.13      | Ditch. NW-SE                         |       |      |
| 19503  | Fill  | 19502   | 1.15      | 0.13      | Primary Fill. Grey firm sandy silt   |       |      |

|       |                     |  |      |  |  |  |  |
|-------|---------------------|--|------|--|--|--|--|
| 19504 | Unexcavated feature |  | 1.32 |  | Ditch. NW-SE.<br>Excavated in TR198.<br>Dark grey sandy silt |  |  |
|-------|---------------------|--|------|--|--|--|--|

| Trench 196  |       |         |           |           |  |       |      |
|---|-------|---------|-----------|-----------|--|-------|------|
| General description   |       |         |           |           | Orientation  | E-W   |      |
| Trench devoid of archaeology. Consisted of ploughsoil and subsoil overlaying the natural geology of light yellow silty sand including patches of brown red silty gravel mix |       |         |           |           | Length (m)   | 30    |      |
|   |       |         |           |           | Width (m)  | 2     |      |
|   |       |         |           |           | Avg. depth (m)   | 0.56  |      |
| Context No.   | Type  | Fill Of | Width (m) | Depth (m) | Description  | Finds | Date |
| 19600   | Layer |         |           | 0.34      | Ploughsoil. Dark brownish grey sandy silt with inclusions of chalk nodules in frequent amounts |       |      |
| 19601   | Layer |         |           | 0.22      | Subsoil. medium brown red sandy silt   |       |      |
| 19602   | Layer |         |           |           | Natural. Light yellowish grey sand with occasional brownish red silty patches                  |       |      |
| 19603   | Cut   |         | 0.82      | 0.11      | Natural Feature. Tree throw hole. Dark brown firm sandy silt with charcoal inclusions.         |       |      |

| Trench 197  |       |         |           |           |  |       |      |
|---|-------|---------|-----------|-----------|--|-------|------|
| General description   |       |         |           |           | Orientation  | N-S   |      |
| Trench devoid of archaeology. Consisted of ploughsoil and subsoil overlaying the natural geology of light yellow silty sand including patches of brown red silty gravel mix |       |         |           |           | Length (m)   | 30    |      |
|   |       |         |           |           | Width (m)  | 2     |      |
|   |       |         |           |           | Avg. depth (m)   | 0.53  |      |
| Context No.   | Type  | Fill Of | Width (m) | Depth (m) | Description  | Finds | Date |
| 19700   | Layer |         |           | 0.31      | Ploughsoil. dark brown silty sand                              |       |      |
| 19701   | Layer |         |           | 0.24      | Subsoil. Brownish red sandy silt and light yellow sand pockets |       |      |
| 19702   | Layer |         |           |           | Natural. Yellow sand.  |       |      |
| 19703   | Void  |         |           |           |  |       |      |

| Trench 198          |  |  |  |  |             |           |  |
|---------------------|--|--|--|--|-------------|-----------|--|
| General description |  |  |  |  | Orientation | NNE - SSW |  |
|                     |  |  |  |  | Length (m)  | 30        |  |
|                     |  |  |  |  | Width (m)   | 2         |  |

| Trench revealed N-S aligned ditches. Consists of ploughsoil and subsoil overlying the natural geology of gravelly clay. |       |         |           |           | Avg. depth (m)  | 0.56  |        |
|---|-------|---------|-----------|-----------|---|-------|--------|
| Context No.   | Type  | Fill Of | Width (m) | Depth (m) | Description   | Finds | Date   |
| 19800   | Layer |         |           | 0.28      | Ploughsoil. Greyish brown, silty clay, frequent flecks of chalk and moderate small sub rounded stones |       |        |
| 19801   | Layer |         |           | 0.24      | Subsoil. Light brownish yellow, sandy clay, moderate small sub angled stones                          |       |        |
| 19802   | Layer |         |           | 0.56      | Natural. Brownish orange, sandy clay, frequent rooting and worm action                                |       |        |
| 19803   | Cut   |         | 1.8       | 0.44      | Ditch. Cut of modern boundary ditch   |       |        |
| 19804   | Fill  | 19803   | 1.8       | 0.44      | Deliberate Backfill. Fill of boundary ditch   | CBM   | C17-18 |
| 19805   | Cut   |         |           |           | Ditch   |       |        |
| 19806   | Fill  | 19805   |           |           | Other Fill  |       |        |
| 19807   | Fill  | 19805   |           |           | Other Fill  |       |        |
| 19808   | Fill  | 19805   |           |           | Other Fill  |       |        |

| <b>Trench 199</b>  |       |         |           |           |  |       |      |
|--|-------|---------|-----------|-----------|--|-------|------|
| General description  |       |         |           |           | Orientation  | NW-SE |      |
| Trench devoid of archaeology. Consisted of ploughsoil and subsoil overlying the natural geology of light yellow silty sand including patches of brown red silty gravel mix |       |         |           |           | Length (m)   | 30    |      |
|  |       |         |           |           | Width (m)  | 2     |      |
|  |       |         |           |           | Avg. depth (m)   | 0.52  |      |
| Context No.  | Type  | Fill Of | Width (m) | Depth (m) | Description  | Finds | Date |
| 19900  | Layer |         | 2         | 0.41      | Ploughsoil. Dark brown grey silty sand                   |       |      |
| 19901  | Layer |         |           | 0.17      | Subsoil. Brown red sandy silt                            |       |      |
| 19902  | Layer |         |           |           | Natural. Reddish yellow sand with patches of clayey silt |       |      |

| <b>Trench 200</b>  |      |         |           |           |                |       |      |
|--|------|---------|-----------|-----------|----------------|-------|------|
| General description  |      |         |           |           | Orientation    | NE-SE |      |
| Trench revealed a single ditch. Consisted of ploughsoil and subsoil overlying the natural geology of light yellow silty sand including patches of brown red silt |      |         |           |           | Length (m)     | 30    |      |
|  |      |         |           |           | Width (m)      | 2     |      |
|  |      |         |           |           | Avg. depth (m) | 0.5   |      |
| Context No.  | Type | Fill Of | Width (m) | Depth (m) | Description    | Finds | Date |

|       |       |  |      |      |   |       |  |
|-------|-------|--|------|------|---|-------|--|
| 20000 | Layer |  |      | 0.35 | Ploughsoil. Dark brown grey silty sand  |       |  |
| 20001 | Layer |  |      | 0.17 | Subsoil. Brownish red sandy silt  |       |  |
| 20002 | Layer |  |      |      | Natural. Brownish red silt with yellow sand patches as well as patches of brownish red sandy gravel patches |       |  |
| 20003 | Cut   |  | 0.67 | 0.26 | Ditch   |       |  |
| 20004 | Fill  |  | 0.67 | 0.26 | Tertiary Fill. Grey brown silty sand.   | Flint |  |

| Trench 201  |       |         |           |           |  |       |      |  |
|---|-------|---------|-----------|-----------|--|-------|------|--|
| General description   |       |         |           |           | Orientation                            | NW-SE |      |  |
| Trench devoid of archaeology. Trench consists of ploughsoil overlying a clayey sand natural |       |         |           |           | Length (m)                             | 30    |      |  |
|   |       |         |           |           | Width (m)                              | 2     |      |  |
|   |       |         |           |           | Avg. depth (m)                         | 0.38  |      |  |
| Context No.   | Type  | Fill Of | Width (m) | Depth (m) | Description                            | Finds | Date |  |
| 20100   | Layer |         |           | 0.38      | Ploughsoil. Dark grey firm clayey silt | Flint |      |  |
| 20101   | Layer |         |           |           | Natural. Reddish brown clayey silt     |       |      |  |

| Trench 202   |       |         |           |           |   |                                  |         |  |
|--|-------|---------|-----------|-----------|---|----------------------------------|---------|--|
| General description  |       |         |           |           | Orientation   | N-S                              |         |  |
| Trench revealed one ditch. Trench itself consists of ploughsoil overlying a natural geology of silty clay with gravel. |       |         |           |           | Length (m)  | 30                               |         |  |
|  |       |         |           |           | Width (m)   | 2                                |         |  |
|  |       |         |           |           | Avg. depth (m)                                      | 0.33                             |         |  |
| Context No.  | Type  | Fill Of | Width (m) | Depth (m) | Description   | Finds                            | Date    |  |
| 20200  | Layer |         |           | 0.33      | Ploughsoil. Brown grey silty clay.                  |                                  |         |  |
| 20201  | Layer |         |           |           | Natural. Light orange brown silty clay with gravel. |                                  |         |  |
| 20202  | Cut   |         | 1.8       | 0.5       | Ditch   |                                  |         |  |
| 20203  | Fill  | 20202   | 1         | 0.2       | Primary Fill. Orange brown sandy silt.              |                                  |         |  |
| 20204  | Fill  | 20202   | 1.3       | 0.23      | Secondary Fill. Yellow brown sandy silt             | Fe                               |         |  |
| 20205  | Fill  | 20202   | 1.8       | 0.16      | Tertiary Fill. Grey brown clayey silt.              | Glass, Fe nail?, Cu alloy handle | 19/20 C |  |

| Trench 203          |  |             |     |
|---------------------|--|-------------|-----|
| General description |  | Orientation | E-W |
|                     |  | Length (m)  | 30  |

| Trench devoid of archaeology. Trench consists of ploughsoil overlying a sandy gravel natural with E-W ploughscarring |       |         |           |           | Width (m)   | 2     |      |  |
|--|-------|---------|-----------|-----------|---|-------|------|--|
|  |       |         |           |           | Avg. depth (m)  | 0.37  |      |  |
| Context No.  | Type  | Fill Of | Width (m) | Depth (m) | Description   | Finds | Date |  |
| 20300  | Layer |         |           | 0.37      | Ploughsoil. Dark grey firm clayey silt                        |       |      |  |
| 20301  | Layer |         |           |           | Natural. Reddish brown gravelly sand with E-W plough scarring |       |      |  |

| <b>Trench 204</b>   |       |         |           |           |   |         |      |  |  |
|---|-------|---------|-----------|-----------|---|---------|------|--|--|
| General description   |       |         |           |           | Orientation   | WNW-ESE |      |  |  |
| Trench devoid of archaeology. Trench consists of ploughsoil overlying a gravelly sand |       |         |           |           | Length (m)  | 30      |      |  |  |
|   |       |         |           |           | Width (m)   | 2       |      |  |  |
|   |       |         |           |           | Avg. depth (m)  | 0.43    |      |  |  |
| Context No.   | Type  | Fill Of | Width (m) | Depth (m) | Description   | Finds   | Date |  |  |
| 20400   | Layer |         |           | 0.34      | Ploughsoil. Firm dark grey clayey silt  |         |      |  |  |
| 20401   | Layer |         |           |           | Natural. Reddish brown gravelly sand  |         |      |  |  |
| 20402   | Cut   |         | 0.67      | 0.09      | Natural Feature. Natural pit. Irregular in shape. Soft light brownish grey sandy silt |         |      |  |  |

| <b>Trench 205</b>   |       |         |           |           |  |       |      |  |  |
|---|-------|---------|-----------|-----------|--|-------|------|--|--|
| General description   |       |         |           |           | Orientation                            | NE-SW |      |  |  |
| Trench devoid of archaeology. Trench consists of ploughsoil and subsoil overlying a sandy gravel natural. |       |         |           |           | Length (m)                             | 30    |      |  |  |
|   |       |         |           |           | Width (m)                              | 2     |      |  |  |
|   |       |         |           |           | Avg. depth (m)                         | 0.54  |      |  |  |
| Context No.   | Type  | Fill Of | Width (m) | Depth (m) | Description                            | Finds | Date |  |  |
| 20500   | Layer |         |           | 0.39      | Ploughsoil. Dark grey firm clayey silt |       |      |  |  |
| 20501   | Layer |         |           | 0.1       | Subsoil. Greyish brown clayey silt     |       |      |  |  |
| 20502   | Layer |         |           |           | Natural. Reddish brown gravelly sand   |       |      |  |  |

| <b>Trench 206</b>   |       |         |           |           |                                     |       |      |  |  |
|---|-------|---------|-----------|-----------|-------------------------------------|-------|------|--|--|
| General description   |       |         |           |           | Orientation                         | N-S   |      |  |  |
| Trench devoid of archaeology. Consisted of ploughsoil and subsoil overlaying the natural geology of light grey clayey sands with gravel bands |       |         |           |           | Length (m)                          | 30    |      |  |  |
|   |       |         |           |           | Width (m)                           | 2     |      |  |  |
|   |       |         |           |           | Avg. depth (m)                      | 0.56  |      |  |  |
| Context No.   | Type  | Fill Of | Width (m) | Depth (m) | Description                         | Finds | Date |  |  |
| 20600   | Layer |         |           | 0.35      | Ploughsoil. Brown grey clayey silt. |       |      |  |  |
| 20601   | Layer |         |           | 0.3       | Subsoil. Grey yellow silty clay.    |       |      |  |  |

|       |       |  |  |  |  |  |  |
|-------|-------|--|--|--|--|--|--|
| 20602 | Layer |  |  |  | Natural. Light yellow grey clayey sands with gravel. |  |  |
|-------|-------|--|--|--|--|--|--|

| <b>Trench 207</b>   |       |         |           |           |  |       |      |
|---|-------|---------|-----------|-----------|--|-------|------|
| General description   |       |         |           |           | Orientation                                |       | E-W  |
| Trench revealed two ditches. Trench contains ploughsoil and subsoil overlying a natural geology of mid reddish brown clayey gravel. |       |         |           |           | Length (m)                                 |       | 30   |
|   |       |         |           |           | Width (m)                                  |       | 2    |
|   |       |         |           |           | Avg. depth (m)                             |       | 0.54 |
| Context No.   | Type  | Fill Of | Width (m) | Depth (m) | Description                                | Finds | Date |
| 20700   | Layer |         |           | 0.32      | Ploughsoil. Brownish grey silty clay.      |       |      |
| 20701   | Layer |         |           | 0.15      | Subsoil. Grey brown silty clay.            |       |      |
| 20702   | Layer |         |           |           | Natural. Reddish brown clayey gravel.      |       |      |
| 20703   | Cut   |         | 0.74      | 0.1       | Ditch                                      |       |      |
| 20704   | Fill  | 20703   | 0.74      | 0.1       | Primary Fill. Grey brown silty clay.       |       |      |
| 20705   | Cut   |         | 0.44      | 0.1       | Ditch                                      |       |      |
| 20706   | Fill  | 20705   | 0.44      | 0.1       | Primary Fill. Light grey brown silty clay. |       |      |

| <b>Trench 208</b>   |       |         |           |           |   |       |      |
|---|-------|---------|-----------|-----------|---|-------|------|
| General description   |       |         |           |           | Orientation   |       | E-W  |
| Trench revealed one ditch. Trench contains ploughsoil and subsoil overlying natural geology of light yellowish brown sand and mid greyish brown gravel. |       |         |           |           | Length (m)  |       | 30   |
|   |       |         |           |           | Width (m)   |       | 2    |
|   |       |         |           |           | Avg. depth (m)  |       | 0.5  |
| Context No.   | Type  | Fill Of | Width (m) | Depth (m) | Description   | Finds | Date |
| 20800   | Layer |         |           | 0.33      | Ploughsoil. Brownish grey silty clay.                             |       |      |
| 20801   | Layer |         |           | 0.12      | Subsoil. Light greyish brown silty clay.                          |       |      |
| 20802   | Layer |         |           |           | Natural. Light yellowish brown sand and mid greyish brown gravel. |       |      |
| 20803   | Cut   |         | 0.88      | 0.2       | Ditch   |       |      |
| 20804   | Fill  | 20803   | 0.88      | 0.2       | Primary Fill. Light yellowish grey clayey silt.                   |       |      |

| <b>Trench 209</b>  |      |         |           |           |                |       |      |
|--|------|---------|-----------|-----------|----------------|-------|------|
| General description  |      |         |           |           | Orientation    |       | N-S  |
| Trench devoid of archaeology. Trench contains ploughsoil and subsoil overlying the natural geology of light yellow brown sand and grey brown clay and gravel |      |         |           |           | Length (m)     |       | 30   |
|  |      |         |           |           | Width (m)      |       | 2    |
|  |      |         |           |           | Avg. depth (m) |       | 0.53 |
| Context No.  | Type | Fill Of | Width (m) | Depth (m) | Description    | Finds | Date |



|       |       |  |  |      |   |  |  |
|-------|-------|--|--|------|---|--|--|
| 20900 | Layer |  |  | 0.33 | Ploughsoil. Firm, Greyish brown, clay-silt                          |  |  |
| 20901 | Layer |  |  | 0.2  | Subsoil. Grey-brown silt-sand with occasional gravel patches        |  |  |
| 20902 | Layer |  |  |      | Natural. Light yellow-brown sand and grey brown clayey gravel bands |  |  |

| Trench 210   |       |         |           |           |   |       |      |
|--|-------|---------|-----------|-----------|---|-------|------|
| General description  |       |         |           |           | Orientation   |       | N-S  |
| Trench devoid of archaeology. Consisted of ploughsoil and subsoil overlaying the natural geology of orange- brown gravel and light yellow-brown sand bands |       |         |           |           | Length (m)  |       | 30   |
|  |       |         |           |           | Width (m)   |       | 2    |
|  |       |         |           |           | Avg. depth (m)  |       | 0.58 |
| Context No.  | Type  | Fill Of | Width (m) | Depth (m) | Description   | Finds | Date |
| 21000  | Layer |         |           |           | Ploughsoil. Firm, Greyish brown, clayey silt                          |       |      |
| 21001  | Layer |         |           | 0.23      | Subsoil. Light brown silty sand                                       |       |      |
| 21002  | Layer |         |           |           | Natural. Orangey brown layer gravel and light yellow brown sand bands |       |      |

| Trench 212   |       |         |           |           |   |       |      |
|--|-------|---------|-----------|-----------|---|-------|------|
| General description  |       |         |           |           | Orientation                                 |       | E-W  |
| Trench revealed a single ditch. Trench consists of ploughsoil and subsoil overlying a silty sand natural |       |         |           |           | Length (m)                                  |       | 30   |
|  |       |         |           |           | Width (m)                                   |       | 2    |
|  |       |         |           |           | Avg. depth (m)                              |       | 0.59 |
| Context No.  | Type  | Fill Of | Width (m) | Depth (m) | Description                                 | Finds | Date |
| 21200  | Layer |         |           | 0.42      | Ploughsoil. Dark grey clayey silt           |       |      |
| 21201  | Layer |         |           | 0.14      | Subsoil. Dark greyish brown sandy silt      |       |      |
| 21202  | Layer |         |           |           | Natural. Reddish brown silty sand           |       |      |
| 21203  | Cut   |         | 1.74      | 0.4       | Ditch. NE-SW                                |       |      |
| 21204  | Fill  | 21203   | 1.74      | 0.4       | Primary Fill. Brownish grey soft sandy silt |       |      |

| Trench 213   |  |  |  |  |                |  |     |
|--|--|--|--|--|----------------|--|-----|
| General description  |  |  |  |  | Orientation    |  | N-S |
| Trench devoid of archaeology. Consisted of ploughsoil and subsoil overlying the natural geology of sandy clay. |  |  |  |  | Length (m)     |  | 30  |
|  |  |  |  |  | Width (m)      |  | 2   |
|  |  |  |  |  | Avg. depth (m) |  | 0.6 |

| Context No. | Type  | Fill Of | Width (m) | Depth (m) | Description   | Finds | Date |
|-------------|-------|---------|-----------|-----------|---|-------|------|
| 21300       | Layer |         | 2         | 0.35      | Ploughsoil. Dark greyish brown, silty clay                                |       |      |
| 21301       | Layer |         | 2         | 0.33      | Subsoil. Greyish brown, silty clay  |       |      |
| 21302       | Layer |         | 2         |           | Natural. Dark reddish brown, sandy clay with patches of sand and gravelly |       |      |
| 21303       | Cut   |         | 1.65      | 0.36      | Natural Feature. Possible tree-throw. No finds.                           |       |      |

| Trench 214   |       |         |           |           |  |                       |                           |
|--|-------|---------|-----------|-----------|--|-----------------------|---------------------------|
| General description  |       |         |           |           | Orientation  |                       | N-S                       |
| Trench consists of ploughsoil and subsoil overlying a clay- sand natural |       |         |           |           | Length (m)   |                       | 30                        |
|  |       |         |           |           | Width (m)  |                       | 2                         |
|  |       |         |           |           | Avg. depth (m)   |                       | 0.55                      |
| Context No.  | Type  | Fill Of | Width (m) | Depth (m) | Description  | Finds                 | Date                      |
| 21400  | Layer |         |           | 0.28      | Ploughsoil. Dark grey clay- silt   |                       |                           |
| 21401  | Layer |         |           | 0.25      | Subsoil. Dark brown- grey firm clay- silt  |                       |                           |
| 21402  | Layer |         |           |           | Natural. Red-brown clay- sand  |                       |                           |
| 21403  | Cut   |         | 0.46      | 0.28      | Natural Feature? Irregular shape in plan. Firm dark brownish grey clay- silt.    |                       |                           |
| 21404  | Cut   |         | 0.71      | 0.21      | Natural Feature. Linear. Uneven base. Firm dark brownish grey clay- silt.        |                       |                           |
| 21405  | Cut   |         | 4.35      |           | Pit. Oval in shape. Soft dark brownish grey silt- sand with charcoal inclusions. |                       |                           |
| 21406  | Fill  | 21403   | 0.46      | 0.28      | Primary fill. Firm dark brownish grey clayey silt.                               | CBM                   | ?                         |
| 21407  | Fill  | 21404   | 0.71      | 0.21      | Primary fill. Firm dark brownish grey clayey silt.                               |                       |                           |
| 21408  | Fill  | 21405   | 4.35      | 0.32      | Soft dark brownish grey sandy silt   | Pot, Animal bone, CBM | Post-medieval (1805-1900) |

| Trench 215   |      |         |           |           |                |       |      |
|--|------|---------|-----------|-----------|----------------|-------|------|
| General description  |      |         |           |           | Orientation    |       | E-W  |
| Trench revealed one ditch. Trench itself consists of ploughsoil and subsoil overlying a natural geology of mid reddish brown silty clay. |      |         |           |           | Length (m)     |       | 30   |
|  |      |         |           |           | Width (m)      |       | 2    |
|  |      |         |           |           | Avg. depth (m) |       | 0.47 |
| Context No.  | Type | Fill Of | Width (m) | Depth (m) | Description    | Finds | Date |

|       |       |       |     |      |  |  |  |
|-------|-------|-------|-----|------|--|--|--|
| 21500 | Layer |       |     | 0.31 | Ploughsoil. Brownish grey silty clay.    |  |  |
| 21501 | Layer |       |     | 0.14 | Subsoil. Light brownish grey silty-clay. |  |  |
| 21502 | Layer |       |     |      | Natural. Reddish brown silty clay.       |  |  |
| 21503 | Cut   |       | 0.8 | 0.3  | Ditch                                    |  |  |
| 21504 | Fill  | 21503 | 0.8 | 0.3  | Primary Fill. Grey brown clayey silt.    |  |  |

| Trench 216  |       |         |           |           |  |       |      |
|---|-------|---------|-----------|-----------|--|-------|------|
| General description   |       |         |           |           | Orientation                                    |       | E-W  |
| Trench revealed a single ditch. Consists of ploughsoil and subsoil overlying natural geology of mid redd-brown sandy silt, with gravel patches. |       |         |           |           | Length (m)                                     |       | 30   |
|   |       |         |           |           | Width (m)                                      |       | 2    |
|   |       |         |           |           | Avg. depth (m)                                 |       | 0.6  |
| Context No.   | Type  | Fill Of | Width (m) | Depth (m) | Description                                    | Finds | Date |
| 21600   | Layer |         |           | 0.33      | Ploughsoil. Brownish grey silty clay.          |       |      |
| 21601   | Layer |         |           | 0.2       | Subsoil. Brownish grey silty clay.             |       |      |
| 21602   | Layer |         |           |           | Natural. Reddish brown sandy silt with gravel. |       |      |
| 21603   | Cut   |         | 1.06      | 0.12      | Other Cut                                      |       |      |
| 21604   | Fill  | 21603   | 1.06      | 0.12      | Primary Fill. Light greyish brown silty clay   |       |      |

| Trench 218  |       |         |           |           |  |                  |       |
|---|-------|---------|-----------|-----------|--|------------------|-------|
| General description   |       |         |           |           | Orientation  |                  | N-S   |
| Trench revealed devoid of archaeology. Consisted of ploughsoil and subsoil overlying the natural geology of bands of orangey brown sandy gravel and light yellowey brown sand |       |         |           |           | Length (m)   |                  | 30    |
|   |       |         |           |           | Width (m)  |                  | 2     |
|   |       |         |           |           | Avg. depth (m)   |                  | 0.53  |
| Context No.   | Type  | Fill Of | Width (m) | Depth (m) | Description  | Finds            | Date  |
| 21700   | Layer |         |           | 0.32      | Ploughsoil. Greyish-brown clayey silt  |                  |       |
| 21701   | Layer |         |           | 0.2       | Subsoil. Firm brown silty clay with frequent small sub angular gravel inclusions |                  |       |
| 21702   | Layer |         |           |           | Natural. Greyish orange sandy clay   |                  |       |
| 21703   | Cut   |         |           |           | Quarry   |                  |       |
| 21704   | Fill  | 21703   |           |           | Friable greyish brown sandy silt   | Pot, Flint flake | Roman |

| Trench 218   |  |  |  |  |                |  |      |
|--|--|--|--|--|----------------|--|------|
| General description  |  |  |  |  | Orientation    |  | N-S  |
| Trench devoid of archaeology. Consisted of ploughsoil and subsoil overlying the natural geology of bands of orangey brown sandy gravel and light yellowey brown sand |  |  |  |  | Length (m)     |  | 30   |
|  |  |  |  |  | Width (m)      |  | 2    |
|  |  |  |  |  | Avg. depth (m) |  | 0.53 |

| Context No. | Type  | Fill Of | Width (m) | Depth (m) | Description   | Finds | Date |
|-------------|-------|---------|-----------|-----------|---|-------|------|
| 21800       | Layer |         |           | 0.32      | Ploughsoil. Firm, greyish-brown, clayey silt                                |       |      |
| 21801       | Layer |         |           | 0.2       | Subsoil. Brown silty clay with frequent small sub angular gravel inclusions |       |      |
| 21802       | Layer |         |           |           | Natural. bands of orangey brown sandy gravel and light yellow brown sand    |       |      |

### Trench 219

| General description  |       |         |           |           | Orientation   | E-W   |      |
|--|-------|---------|-----------|-----------|---|-------|------|
| Trench devoid of archaeology. Consisted of ploughsoil and subsoil overlaying the natural geology of orangey brown sandy gravel |       |         |           |           | Length (m)  | 30    |      |
|  |       |         |           |           | Width (m)   | 2     |      |
|  |       |         |           |           | Avg. depth (m)  | 0.5   |      |
| Context No.  | Type  | Fill Of | Width (m) | Depth (m) | Description   | Finds | Date |
| 21900  | Layer |         |           | 0.35      | Ploughsoil. Firm, greyish-brown, clayey silt                            |       |      |
| 21901  | Layer |         |           | 0.15      | Subsoil. Brown silty clay with occasional pockets of sub angular gravel |       |      |
| 21902  | Layer |         |           |           | Natural. orangey brown sandy gravel                                     |       |      |

### Trench 220

| General description   |       |         |           |           | Orientation  | NW-SE |      |
|---|-------|---------|-----------|-----------|--|-------|------|
| Trench revealed two intercut ditches. Consists of ploughsoil and subsoil overlying natural geology of mid greyish-orange silty clay, with frequent gravel deposits. |       |         |           |           | Length (m)   | 30    |      |
|   |       |         |           |           | Width (m)  | 2     |      |
|   |       |         |           |           | Avg. depth (m)   | 0.58  |      |
| Context No.   | Type  | Fill Of | Width (m) | Depth (m) | Description  | Finds | Date |
| 22000   | Layer |         |           | 0.34      | Ploughsoil. Firm, greyish-brown, clayey silt   |       |      |
| 22001   | Layer |         |           | 0.24      | Subsoil. Moderately-compacted, light greyish brown, silty clay   |       |      |
| 22002   | Layer |         | 2         |           | Natural. Greyish-orange, silty clay with frequent gravel deposits  |       |      |
| 22003   | Cut   |         |           |           | Ditch  |       |      |
| 22004   | Cut   |         |           |           | Ditch. Firmly compacted, light greyish brown, silty clay with occasional small subrounded stones           |       |      |
| 22005   | Cut   |         | 0.68      | 0.15      | Ditch  |       |      |
| 22006   | Fill  | 22005   | 0.68      | 0.15      | Primary Fill. Firmly-compacted, greyish brown, silty clay with moderate amounts of small subangular stones |       |      |

| <b>Trench 221</b>  |       |         |           |           |  |           |         |
|--|-------|---------|-----------|-----------|--|-----------|---------|
| General description  |       |         |           |           | Orientation  |           | NE-SW   |
| Trench revealed four ditches. Consists of ploughsoil and subsoil overlying natural geology of mid reddish brown silty clay, with gravel patches. |       |         |           |           | Length (m)   |           | 30      |
|  |       |         |           |           | Width (m)  |           | 2       |
|  |       |         |           |           | Avg. depth (m)   |           | 0.46    |
| Context No.  | Type  | Fill Of | Width (m) | Depth (m) | Description  | Finds     | Date    |
| 22100  | Layer |         |           | 0.3       | Ploughsoil. Loose greyish brown clayey silt                      |           |         |
| 22101  | Layer |         |           | 0.11      | Subsoil. Soft dark greyish brown silty clay.                     |           |         |
| 22102  | Layer |         |           |           | Natural. Reddish brown, silty clay with gravel.                  |           |         |
| 22103  | Cut   |         | 0.94      | 0.23      | Ditch  |           |         |
| 22104  | Fill  | 22103   | 0.94      | 0.23      | Primary Fill. Greyish brown, silty clay                          | Pot       | LIA-ERB |
| 22105  | Cut   |         | 1.33      | 0.3       | Ditch  |           |         |
| 22106  | Fill  | 22105   | 1.33      | 0.3       | Primary Fill. Greyish brown silty clay.                          | Pot       | LBA-EIA |
| 22107  | Cut   |         | 0.54      | 0.26      | Ditch  |           |         |
| 22108  | Fill  | 22107   | 0.54      | 0.26      | Primary Fill. Brownish grey silty clay.                          | Clay Pipe | Pmed    |
| 22109  | Cut   |         | 1.06      | 0.16      | Natural Feature?   | Flint     |         |
| 22110  | Fill  | 22109   | 1.06      | 0.16      | Primary Fill. Firmly-compacted, light greyish-orange, silty clay |           |         |

| <b>Trench 222</b>   |       |         |           |           |  |       |         |
|---|-------|---------|-----------|-----------|--|-------|---------|
| General description   |       |         |           |           | Orientation  |       | NNW-SSE |
| Trench is devoid of archaeology. It consists of ploughsoil and subsoil above a reddish brown silty clay natural with occasional gravel deposits |       |         |           |           | Length (m)   |       | 30      |
|   |       |         |           |           | Width (m)  |       | 2       |
|   |       |         |           |           | Avg. depth (m)   |       | 0.44    |
| Context No.   | Type  | Fill Of | Width (m) | Depth (m) | Description  | Finds | Date    |
| 22200   | Layer |         |           | 0.38      | Ploughsoil. Firm, Greyish brown, clayey silt                       |       |         |
| 22201   | Layer |         |           | 0.06      | Subsoil. Moderately-compacted, light greyish brown, silty clay     |       |         |
| 22202   | Layer |         |           |           | Natural. Reddish brown, silty clay with occasional gravel deposits |       |         |
| 22203   | Cut   |         | 1         |           | Natural Feature  |       |         |

| <b>Trench 223</b>   |  |  |  |  |                |  |         |
|---|--|--|--|--|----------------|--|---------|
| General description   |  |  |  |  | Orientation    |  | NNW-SSE |
| Trench is devoid of archaeology. It consists of ploughsoil and subsoil above a mid orangish-brown, silty clay natural |  |  |  |  | Length (m)     |  | 30      |
|   |  |  |  |  | Width (m)      |  | 2       |
|   |  |  |  |  | Avg. depth (m) |  | 0.68    |

| Context No. | Type  | Fill Of | Width (m) | Depth (m) | Description  | Finds | Date |
|-------------|-------|---------|-----------|-----------|--|-------|------|
| 22300       | Layer |         |           | 0.41      | Ploughsoil. Firm, mid greyish brown, clayey silt               |       |      |
| 22301       | Layer |         |           | 0.27      | Subsoil. Moderately-compacted, light greyish brown, silty clay |       |      |
| 22302       | Layer |         | 2         |           | Natural. Mid orangish brown, silty clay                        |       |      |

| <b>Trench 224</b>  |       |         |           |           |   |       |      |
|--|-------|---------|-----------|-----------|---|-------|------|
| General description  |       |         |           |           | Orientation   | NE-SW |      |
| Trench revealed a single ditch and a natural feature. Consists of ploughsoil and subsoil overlying natural geology of light greyish orange silty clay. |       |         |           |           | Length (m)  | 30    |      |
|  |       |         |           |           | Width (m)   | 2     |      |
|  |       |         |           |           | Avg. depth (m)  | 0.59  |      |
| Context No.  | Type  | Fill Of | Width (m) | Depth (m) | Description   | Finds | Date |
| 22400  | Layer |         |           | 0.34      | Ploughsoil. Firm, mid greyish brown, clayey silt                |       |      |
| 22401  | Layer |         |           | 0.25      | Subsoil. Firm, light greyish brown, silty clay                  |       |      |
| 22402  | Layer |         | 2         |           | Natural. Light greyish orange, silty clay                       |       |      |
| 22403  | Cut   |         | 0.85      | 0.19      | Ditch   |       |      |
| 22404  | Fill  | 22403   | 0.85      | 0.19      | Primary Fill. Firmly-compacted, light brownish-grey, silty clay |       |      |
| 22405  | Cut   |         |           |           | Natural Feature   |       |      |

| <b>Trench 225</b>   |       |         |           |           |   |       |      |
|---|-------|---------|-----------|-----------|---|-------|------|
| General description   |       |         |           |           | Orientation   | NE-SW |      |
| Trench is devoid of archaeology. It consists of ploughsoil and subsoil above a mid reddish brown silty clay natural with occasional gravel inclusions |       |         |           |           | Length (m)  | 30    |      |
|   |       |         |           |           | Width (m)   | 2     |      |
|   |       |         |           |           | Avg. depth (m)  | 0.35  |      |
| Context No.   | Type  | Fill Of | Width (m) | Depth (m) | Description   | Finds | Date |
| 22500   | Layer |         |           | 0.24      | Ploughsoil. Firm, mid greyish brown, clayey silt                          |       |      |
| 22501   | Layer |         |           | 0.11      | Subsoil. Loose, light greyish brown, silty clay                           |       |      |
| 22502   | Layer |         | 2         |           | Natural. Mid reddish brown, silty clay with occasional gravel inclusions. |       |      |

| <b>Trench 226</b>   |  |  |  |  |             |       |  |
|---|--|--|--|--|-------------|-------|--|
| General description   |  |  |  |  | Orientation | NE-SW |  |
| Trench devoid of archaeology. Consists of ploughsoil and subsoil overlying natural geology of silty clay. |  |  |  |  | Length (m)  | 30    |  |
|   |  |  |  |  | Width (m)   | 2     |  |

|             |       |         |           |           |  | Avg. depth (m) | 0.56 |
|-------------|-------|---------|-----------|-----------|--|----------------|------|
| Context No. | Type  | Fill Of | Width (m) | Depth (m) | Description                              | Finds          | Date |
| 22600       | Layer |         |           | 0.34      | Ploughsoil. Mid brownish grey silty clay |                |      |
| 22601       | Layer |         |           | 0.22      | Subsoil. Light greyish brown silty clay  |                |      |
| 22602       | Layer |         |           |           | Natural. Mid reddish brown silty clay    |                |      |

| <b>Trench 227</b>   |       |         |           |           |  |       |              |
|---|-------|---------|-----------|-----------|--|-------|--------------|
| General description   |       |         |           |           | Orientation  | E-W   |              |
| Trench revealed a single ditch. Consists of ploughsoil and subsoil overlying natural geology of sandy clay. |       |         |           |           | Length (m)   | 30    |              |
|   |       |         |           |           | Width (m)  | 2     |              |
|   |       |         |           |           | Avg. depth (m)   | 0.7   |              |
| Context No.   | Type  | Fill Of | Width (m) | Depth (m) | Description  | Finds | Date         |
| 22700   | Layer |         |           |           | Ploughsoil. Mid brownish grey silty clay.                          |       |              |
| 22701   | Layer |         |           |           | Subsoil. Light greyish brown silty clay                            |       |              |
| 22702   | Layer |         |           |           | Natural. Mid reddish brown silty clay.                             |       |              |
| 22703   | Cut   |         | 1.05      |           | Ditch running roughly NE-SW  |       |              |
| 22704   | Fill  | 22703   | 1.05      |           | Placed Deposit. Dark brownish grey silt with much organic content. | Glass | C19th / 20th |

| <b>Trench 228</b>  |       |         |           |           |  |       |      |
|--|-------|---------|-----------|-----------|--|-------|------|
| General description  |       |         |           |           | Orientation                                  | N-S   |      |
| Trench devoid of archaeology. Trench consists of ploughsoil and subsoil overlying natural geology of silty clay. |       |         |           |           | Length (m)                                   | 30    |      |
|  |       |         |           |           | Width (m)                                    | 1.8   |      |
|  |       |         |           |           | Avg. depth (m)                               | 0.42  |      |
| Context No.  | Type  | Fill Of | Width (m) | Depth (m) | Description                                  | Finds | Date |
| 22800  | Layer |         |           | 0.34      | Ploughsoil. Dark brownish grey sandy silt.   |       |      |
| 22801  | Layer |         |           | 0.08      | Subsoil. Mid reddish brown clayey sand.      | Flint |      |
| 22802  | Layer |         |           | 0.24      | Alluvial Layer. Mid brownish red silty clay. | Flint |      |
| 22803  | Layer |         |           |           | Natural. Light yellowish brown sandy clay.   |       |      |

| <b>Trench 229</b>   |  |  |  |  |                |       |  |
|---|--|--|--|--|----------------|-------|--|
| General description   |  |  |  |  | Orientation    | NE-SW |  |
| Trench devoid of archaeology. Consists of ploughsoil and subsoil overlying natural geology of silty clay. |  |  |  |  | Length (m)     | 30    |  |
|   |  |  |  |  | Width (m)      | 1.8   |  |
|   |  |  |  |  | Avg. depth (m) | 0.36  |  |

| Context No. | Type  | Fill Of | Width (m) | Depth (m) | Description                                | Finds | Date |
|-------------|-------|---------|-----------|-----------|--|-------|------|
| 22900       | Layer |         |           | 0.29      | Ploughsoil. Dark brownish grey sandy silt. |       |      |
| 22901       | Layer |         |           | 0.07      | Subsoil. Mid orangish brown clayey sand.   |       |      |
| 22902       | Layer |         |           |           | Natural. Mid brownish orange sandy clay.   |       |      |

| Trench 230   |       |         |           |           |  |             |      |
|--|-------|---------|-----------|-----------|--|-------------|------|
| General description  |       |         |           |           | Orientation                                    | E-W         |      |
| Trench revealed one ditch. Consists of ploughsoil, subsoil and alluvial layer overlying natural geology of silty clay. |       |         |           |           | Length (m)                                     | 30          |      |
|  |       |         |           |           | Width (m)                                      | 1.8         |      |
|  |       |         |           |           | Avg. depth (m)                                 | 0.68        |      |
| Context No.  | Type  | Fill Of | Width (m) | Depth (m) | Description                                    | Finds       | Date |
| 23000  | Layer |         |           | 0.32      | Ploughsoil. Dark brownish grey clayey silt.    |             |      |
| 23001  | Layer |         |           | 0.05      | Subsoil. Mid yellowish brown silty clay.       |             |      |
| 23002  | Layer |         |           | 0.29      | Alluvial Layer. Mid orangish brown sandy clay. | Burnt Flint |      |
| 23003  | Layer |         |           |           | Natural. Mid brownish orange sandy clay.       |             |      |
| 23004  | Cut   |         | 1.55      | 0.27      | Ditch  |             |      |
| 23005  | Fill  | 23004   | 1.55      | 0.29      | Secondary Fill. Mid blueish grey sandy clay    | Fe strip    | ?    |
| 23006  | Cut   |         | 3.3       | 0.4       | Possible ditch                                 |             |      |
| 23007  | Fill  | 23006   |           |           | Light blueish grey sandy clay                  |             |      |

| Trench 231  |       |         |           |           |  |       |      |
|---|-------|---------|-----------|-----------|--|-------|------|
| General description   |       |         |           |           | Orientation                                  | N-S   |      |
| Trench revealed one pit. Consists of ploughsoil and subsoil overlying natural geology of sandy gravels. |       |         |           |           | Length (m)                                   | 30    |      |
|   |       |         |           |           | Width (m)                                    | 2     |      |
|   |       |         |           |           | Avg. depth (m)                               |       |      |
| Context No.   | Type  | Fill Of | Width (m) | Depth (m) | Description                                  | Finds | Date |
| 23100   | Layer |         |           | 0.27      | Ploughsoil. Dark brownish grey clayey silt.  |       |      |
| 23101   | Layer |         |           | 0.14      | Subsoil. Mid yellowish brown silty clay      |       |      |
| 23102   | Layer |         |           |           | Natural. Mid yellowish brown sandy gravels.  | Flint |      |
| 23103   | Cut   |         | 0.97      | 0.49+     | Pit. Not bottomed                            |       |      |
| 23104   | Fill  | 23103   | 0.97      | 0.49      | Primary Fill. Light blueish grey sandy clay. |       |      |

| Trench 232          |  |  |  |  |             |     |  |
|---------------------|--|--|--|--|-------------|-----|--|
| General description |  |  |  |  | Orientation | E-W |  |



| Consists of ploughsoil and subsoil overlying natural geology of silty clay with gravels. |       |         |           |           |   | Length (m)     | 30   |
|--|-------|---------|-----------|-----------|---|----------------|------|
|  |       |         |           |           |   | Width (m)      | 2    |
|  |       |         |           |           |   | Avg. depth (m) |      |
| Context No.  | Type  | Fill Of | Width (m) | Depth (m) | Description   | Finds          | Date |
| 23200  | Layer |         |           | 0.36      | Ploughsoil. Dark brownish grey clayey silt.         |                |      |
| 23201  | Layer |         |           | 0.24      | Subsoil. Mid yellowish brown clayey silt.           |                |      |
| 23202  | Layer |         |           |           | Natural. Mid reddish brown silty clay with gravels. |                |      |
| 23203  | Cut   |         | 0.52      | 0.27      | Ditch   |                |      |
| 23204  | Fill  | 23203   |           | 0.27      | Greyish blue silty clay                             |                |      |

| <b>Trench 235</b>  |                     |         |           |           |  |                |       |
|--|---------------------|---------|-----------|-----------|--|----------------|-------|
| General description  |                     |         |           |           |  | Orientation    | NW-SE |
| Trench devoid of archaeology. Trench consists of ploughsoil, subsoil and alluvial layers overlying a silty clay natural. |                     |         |           |           |  | Length (m)     | 30    |
|  |                     |         |           |           |  | Width (m)      | 1.8   |
|  |                     |         |           |           |  | Avg. depth (m) | 0.42  |
| Context No.  | Type                | Fill Of | Width (m) | Depth (m) | Description  | Finds          | Date  |
| 23500  | Layer               |         |           | 0.34      | Ploughsoil. Dark brownish grey sandy silt.   | Flint          |       |
| 23501  | Layer               |         |           | 0.08      | Subsoil. Orangish brown clayey sand.   | Flint          |       |
| 23502  | Layer               |         |           |           | Natural. Brownish red silty clay with gravels.   | Flint          |       |
| 23503  | Void                |         |           |           |  |                |       |
| 23504  | Layer               |         |           |           | Alluvial Layer. Blueish grey clayey gravel. Below 23505, and not bottomed due to being below 1m. |                |       |
| 23505  | Layer               |         |           | 0.18      | Alluvial Layer. Orange brown silty clay, Freq small stones. Below 23506 and over 23504.          |                |       |
| 23506  | Layer               |         |           | 0.33      | Alluvial Layer. Reddish brown clayey silt overlying 23505. Rare flint on the surface.            | Flint          |       |
| 23507  | Unexcavated feature |         | 1.02      |           | Ditch  |                |       |

| <b>Trench 236</b>   |  |  |  |  |  |             |     |
|---|--|--|--|--|--|-------------|-----|
| General description   |  |  |  |  |  | Orientation | N-S |
| Trench devoid of archaeology. Consists of ploughsoil and subsoil overlying natural geology of silty clay. |  |  |  |  |  | Length (m)  | 30  |
|   |  |  |  |  |  | Width (m)   | 1.8 |

|             |       |         |           |           |   | Avg. depth (m) | 0.4<br>2 |
|-------------|-------|---------|-----------|-----------|---|----------------|----------|
| Context No. | Type  | Fill Of | Width (m) | Depth (m) | Description   | Finds          | Date     |
| 23600       | Layer |         |           | 0.36      | Ploughsoil. Dark brownish grey sandy silt.          |                |          |
| 23601       | Layer |         |           | 0.06      | Subsoil. Mid orangish brown clayey sand.            | Flint          |          |
| 23602       | Layer |         |           |           | Natural. Mid reddish brown silty clay with gravels. |                |          |

| <b>Trench 237</b>   |                     |         |           |           |   |       |      |
|---|---------------------|---------|-----------|-----------|---|-------|------|
| General description   |                     |         |           |           | Orientation   | E-W   |      |
| Trench revealed four ditches. Consists of ploughsoil and subsoil overlying natural geology of silty clay. |                     |         |           |           | Length (m)  | 30    |      |
|   |                     |         |           |           | Width (m)   | 1.8   |      |
|   |                     |         |           |           | Avg. depth (m)  |       |      |
| Context No.   | Type                | Fill Of | Width (m) | Depth (m) | Description   | Finds | Date |
| 23700   | Layer               |         |           | 0.34      | Ploughsoil. Dark brownish grey sandy silt.              |       |      |
| 23701   | Layer               |         |           | 0.1       | Subsoil. Mid yellowish brown clayey sand.               | Flint |      |
| 23702   | Layer               |         |           |           | Alluvial Layer. Mid brownish orange sandy clay          |       |      |
| 23703   | Layer               |         |           |           | Natural. Mid brownish red silty clay.                   |       |      |
| 23704   | Cut                 |         | 0.6       | 0.2       | Ditch   |       |      |
| 23705   | Fill                | 23704   |           |           | Primary Fill. Mid bluish grey sandy clay.               |       |      |
| 23706   | Cut                 |         | 1.08      | 0.24      | Ditch   |       |      |
| 23707   | Fill                | 23706   | 1.08      | 0.24      | Primary Fill. Mottled bluish grey and brown sandy clay. |       |      |
| 23708   | Cut                 |         | 2.19      | 0.21      | Ditch   |       |      |
| 23709   | Fill                | 23708   | 2.19      | 0.21      | Primary Fill. Mid greyish blue silty clay.              |       |      |
| 23710   | Cut                 |         | 1.44      | 0.38+     | Ditch. Not bottomed                                     |       |      |
| 23711   | Fill                | 23710   | 1.44      | 0.38      | Primary Fill. Blueish grey sandy clay                   |       |      |
| 23712   | Unexcavated feature |         |           |           | Ditch. Mid grey sandy clay                              |       |      |

| <b>Trench 238</b>   |      |         |           |           |                |       |      |
|---|------|---------|-----------|-----------|----------------|-------|------|
| General description   |      |         |           |           | Orientation    | NE-SW |      |
| Trench devoid of archaeology. Trench consists of ploughsoil and subsoil overlying natural geology of silty clay with gravels. |      |         |           |           | Length (m)     | 30    |      |
|   |      |         |           |           | Width (m)      | 1.8   |      |
|   |      |         |           |           | Avg. depth (m) | 0.45  |      |
| Context No.   | Type | Fill Of | Width (m) | Depth (m) | Description    | Finds | Date |

|       |       |  |  |      |   |  |  |
|-------|-------|--|--|------|---|--|--|
| 23800 | Layer |  |  | 0.38 | Ploughsoil. Dark brownish grey clayey silt. |  |  |
| 23801 | Layer |  |  | 0.08 | Subsoil. Mid yellowish brown silty clay.    |  |  |
| 23802 | Layer |  |  |      | Natural. Mid reddish brown sandy gravels.   |  |  |

| Trench 239   |       |         |           |           |   |       |      |
|--|-------|---------|-----------|-----------|---|-------|------|
| General description  |       |         |           |           | Orientation                                 | NW-SE |      |
| Trench devoid of archaeology. Consists of ploughsoil and subsoil overlying natural geology of sandy clay with gravels. |       |         |           |           | Length (m)                                  | 30    |      |
|  |       |         |           |           | Width (m)                                   | 1.8   |      |
|  |       |         |           |           | Avg. depth (m)                              | 0.38  |      |
| Context No.  | Type  | Fill Of | Width (m) | Depth (m) | Description                                 | Finds | Date |
| 23900  | Layer |         |           | 0.32      | Ploughsoil. Dark brownish grey sandy silt.  |       |      |
| 23901  | Layer |         |           | 0.06      | Subsoil. Light orangish brown, clayey sand. |       |      |
| 23902  | Layer |         |           |           | Natural. Mid brownish red sandy clay.       |       |      |

| Trench 240  |       |         |           |           |  |       |      |
|---|-------|---------|-----------|-----------|--|-------|------|
| General description   |       |         |           |           | Orientation                                | E-W   |      |
| Trench devoid of archaeology. Consists of ploughsoil and subsoil overlying natural geology of sandy clay with gravelly patches. |       |         |           |           | Length (m)                                 | 30    |      |
|   |       |         |           |           | Width (m)                                  | 1.8   |      |
|   |       |         |           |           | Avg. depth (m)                             | 0.44  |      |
| Context No.   | Type  | Fill Of | Width (m) | Depth (m) | Description                                | Finds | Date |
| 24000   | Layer |         |           | 0.35      | Ploughsoil. Dark brownish grey sandy silt. | Flint |      |
| 24001   | Layer |         |           | 0.09      | Subsoil. Light orangish brown clayey sand. |       |      |
| 24002   | Layer |         |           |           | Natural. Mid brownish red sandy clay.      |       |      |

| Trench 241  |      |         |           |           |                |       |      |
|---|------|---------|-----------|-----------|----------------|-------|------|
| General description   |      |         |           |           | Orientation    | NE-SW |      |
| Trench devoid of archaeology. Consists of ploughsoil and subsoil overlying natural geology of sandy clay with gravelly patches. |      |         |           |           | Length (m)     | 30    |      |
|   |      |         |           |           | Width (m)      | 1.8   |      |
|   |      |         |           |           | Avg. depth (m) | 0.39  |      |
| Context No.   | Type | Fill Of | Width (m) | Depth (m) | Description    | Finds | Date |

|       |       |  |  |      |  |  |  |
|-------|-------|--|--|------|--|--|--|
| 24100 | Layer |  |  | 0.3  | Ploughsoil. Dark brownish grey sandy silt.         |  |  |
| 24101 | Layer |  |  | 0.07 | Subsoil. Light reddish brown sandy clay.           |  |  |
| 24102 | Layer |  |  |      | Natural. Mid brownish red sandy clay with gravels. |  |  |

| Trench 242          |       |         |           |           |  |       |      |
|---------------------|-------|---------|-----------|-----------|--|-------|------|
| General description |       |         |           |           | Orientation                                    | N-S   |      |
|                     |       |         |           |           | Length (m)                                     | 30    |      |
|                     |       |         |           |           | Width (m)                                      | 1.8   |      |
|                     |       |         |           |           | Avg. depth (m)                                 | 0.37  |      |
| Context No.         | Type  | Fill Of | Width (m) | Depth (m) | Description                                    | Finds | Date |
| 24200               | Layer |         |           | 0.3       | Ploughsoil. Dark brownish grey sandy silt.     |       |      |
| 24201               | Layer |         |           | 0.07      | Subsoil. Light reddish brown sandy clay.       |       |      |
| 24202               | Layer |         |           |           | Natural. Brownish red sandy clay with gravels. | Flint |      |

| Trench 243  |                     |         |           |           |   |                  |        |
|---|---------------------|---------|-----------|-----------|---|------------------|--------|
| General description   |                     |         |           |           | Orientation   | E-W              |        |
| Trench revealed three ditches. Consists of ploughsoil and subsoil overlying natural geology of sandy clay with gravels. |                     |         |           |           | Length (m)  | 30               |        |
|   |                     |         |           |           | Width (m)   | 1.8              |        |
|   |                     |         |           |           | Avg. depth (m)  | 0.49             |        |
| Context No.   | Type                | Fill Of | Width (m) | Depth (m) | Description   | Finds            | Date   |
| 24300   | Layer               |         |           | 0.37      | Ploughsoil. Dark brownish grey sandy silt.                        | Flint            |        |
| 24301   | Layer               |         |           | 0.12      | Subsoil. Light reddish brown sandy clay.                          |                  |        |
| 24302   | Layer               |         |           |           | Natural. Brownish red sandy clay with gravels.                    | Flint            |        |
| 24303   | Cut                 |         | 0.64      | 0.18      | Ditch. NW-SE  |                  |        |
| 24304   | Fill                | 24303   | 0.64      | 0.18      | Primary Fill. Firm light yellowish grey clayey silt               | Pot, Burnt flint | MBA-IA |
| 24305   | Cut                 |         | 1.29      | 0.27      | Ditch. NW-SE  |                  |        |
| 24306   | Fill                | 24305   | 1.29      | 0.27      | Primary Fill. Light yellowish blue firm clayey silt               | Flint            |        |
| 24307   | Unexcavated feature |         | 3.19      |           | Ditch. Boundary ditch exc. In 244. Dark greyish brown clayey silt |                  |        |

| Trench 244 |  |  |  |  |  |  |  |
|------------|--|--|--|--|--|--|--|
|------------|--|--|--|--|--|--|--|

| General description  |                     |         |           |           |   | Orientation        | E-W  |
|--|---------------------|---------|-----------|-----------|---|--------------------|------|
| Trench revealed three ditches. Consists of ploughsoil and subsoil overlying natural geology of sandy clay. |                     |         |           |           |   | Length (m)         | 50   |
|  |                     |         |           |           |   | Width (m)          | 1.8  |
|  |                     |         |           |           |   | Avg. depth (m)     | 0.47 |
| Context No.  | Type                | Fill Of | Width (m) | Depth (m) | Description   | Finds              | Date |
| 24400  | Layer               |         |           | 0.37      | Ploughsoil. Dark brownish grey sandy silt.          |                    |      |
| 24401  | Layer               |         |           | 0.11      | Subsoil. Light reddish brown clayey sand.           |                    |      |
| 24402  | Layer               |         |           |           | Natural. Mid brownish orange sandy clay.            | Flint              |      |
| 24403  | Cut                 |         | 3.58      | 0.53      | Ditch. N-S  |                    |      |
| 24404  | Cut                 |         | 2.6       | 0.54      | Ditch. N-S  |                    |      |
| 24405  | Fill                | 24403   | 2.61      | 0.36      | Secondary Fill. Soft dark greyish brown clayey silt | Animal bone, flint |      |
| 24406  | Fill                | 24404   | 2.6       | 0.54      | Secondary Fill. Soft dark reddish brown clayey silt |                    |      |
| 24407  | Fill                | 24404   | 0.61      | 0.2       | Primary Fill. Soft dark reddish brown silty clay    |                    |      |
| 24408  | Unexcavated feature |         |           |           | Ditch. Same as ditch in 247 and 248.                |                    |      |
| 24409  | Fill                | 24403   |           | 0.25      | Primary Fill. Light blueish grey firm clayey silt   |                    |      |

### Trench 245

| General description   |       |         |           |           |   | Orientation    | N-S  |
|---|-------|---------|-----------|-----------|---|----------------|------|
| Trench revealed one ditch. Consists of ploughsoil and subsoil overlying natural geology of sandy clay with gravels. |       |         |           |           |   | Length (m)     | 30   |
|   |       |         |           |           |   | Width (m)      | 1.8  |
|   |       |         |           |           |   | Avg. depth (m) | 0.48 |
| Context No.   | Type  | Fill Of | Width (m) | Depth (m) | Description   | Finds          | Date |
| 24500   | Layer |         |           | 0.36      | Ploughsoil. Dark brownish grey sandy silt.                | Flint          |      |
| 24501   | Layer |         |           | 0.12      | Subsoil. Light orangish brown sandy clay.                 | Flint          |      |
| 24502   | Layer |         |           |           | Natural. Light brownish orange sandy clay.                |                |      |
| 24503   | Cut   |         | 1.06      | 0.42      | Ditch. NW-SE  |                |      |
| 24504   | Fill  | 24503   | 1.06      | 0.42      | Primary Fill. Mid greyish blue silty clay. Compact. <S28> |                |      |

### Trench 246

|   |  |  |  |  |  |             |       |
|---|--|--|--|--|--|-------------|-------|
| General description   |  |  |  |  |  | Orientation | NE-SW |
| Trench revealed one ditch. Consists of ploughsoil and subsoil overlying natural geology of sandy clay with gravels. |  |  |  |  |  | Length (m)  | 30    |
|   |  |  |  |  |  | Width (m)   | 1.8   |

|             |       |         |           |           |   | Avg. depth (m) | 0.47      |
|-------------|-------|---------|-----------|-----------|---|----------------|-----------|
| Context No. | Type  | Fill Of | Width (m) | Depth (m) | Description                                       | Finds          | Date      |
| 24600       | Layer |         |           | 0.36      | Ploughsoil. Dark brownish grey sandy silt.        |                |           |
| 24601       | Layer |         |           | 0.11      | Subsoil. Light orangish brown sandy clay.         |                |           |
| 24602       | Layer |         |           |           | Natural. Light to mid brownish orange sandy clay. |                |           |
| 24603       | Cut   |         | 1.7       | 0.42      | Ditch   |                |           |
| 24604       | Fill  | 24603   | 1.56      | 0.6       | Primary Fill. Mid greyish orange sandy clay.      | CBM            | Pmed C16? |
| 24605       | Void  |         |           |           |   |                |           |

| <b>Trench 247</b>  |       |         |           |           |   |                    |      |
|--|-------|---------|-----------|-----------|---|--------------------|------|
| General description  |       |         |           |           | Orientation   | NW-SE              |      |
| Trench revealed three ditches and a layer. Consists of ploughsoil and subsoil overlying natural geology of sandy clay. |       |         |           |           | Length (m)  | 30                 |      |
|  |       |         |           |           | Width (m)   | 1.8                |      |
|  |       |         |           |           | Avg. depth (m)  | 0.45               |      |
| Context No.  | Type  | Fill Of | Width (m) | Depth (m) | Description   | Finds              | Date |
| 24700  | Layer |         |           | 0.35      | Ploughsoil. Dark brownish grey sandy silt.  |                    |      |
| 24701  | Layer |         |           | 0.11      | Subsoil. Light orangish brown clayey sand.  |                    |      |
| 24702  | Layer |         |           |           | Natural. Mid brownish orange sandy clay.  |                    |      |
| 24703  | Cut   |         | 0.46      | 0.35      | Ditch. Cut of ditch running E-W   |                    |      |
| 24704  | Fill  | 24703   | 0.46      | 0.35      | Placed Deposit. Med greyish brown, silty clay, occ. unworked flint                |                    |      |
| 24705  | Cut   |         | 1.96      | 0.54      | Ditch. Cut of ditch   |                    |      |
| 24706  | Fill  | 24705   | 0.12      | 0.48      | Mid yellowish brown, silty clay, occ. Small sub angled stones                     |                    |      |
| 24707  | Fill  | 24705   | 0.3       | 1.68      | Lower fill. Mid greyish black with blue hue, silty clay, frequent charcoal pieces |                    |      |
| 24708  | Fill  | 24705   | 1.96      | 0.28      | Top fill. Med mottled yellowish brown, silty clay, v. occ. animal bone and glass  | Animal bone, Glass | 20C  |

|       |       |       |      |      |  |       |              |
|-------|-------|-------|------|------|--|-------|--------------|
| 24709 | Cut   |       | 1.08 | 0.36 | Ditch. Cut of ditch  |       |              |
| 24710 | Fill  | 24709 | 0.82 | 0.12 | Primary Fill. Med orangish brown, silty clay, occasional small sub angled stones |       |              |
| 24711 | Fill  | 24709 | 1.08 | 0.24 | Secondary Fill. Light orangish brown, silty clay, occasional sub angled stones   |       |              |
| 24712 | Layer |       | 2.44 | 0.24 | Other Layer. Med yellowish brown, silty clay.                                    | Glass | L19/E20<br>C |

| <b>Trench 248</b>   |                     |         |           |           |  |                |      |
|---|---------------------|---------|-----------|-----------|--|----------------|------|
| General description   |                     |         |           |           |  | Orientation    | N-S  |
| Trench revealed one ditch. Consists of ploughsoil and subsoil overlying natural geology of sandy clay with gravels. |                     |         |           |           |  | Length (m)     | 30   |
|   |                     |         |           |           |  | Width (m)      | 1.8  |
|   |                     |         |           |           |  | Avg. depth (m) | 0.48 |
| Context No.   | Type                | Fill Of | Width (m) | Depth (m) | Description                                | Finds          | Date |
| 24800   | Layer               |         |           | 0.37      | Ploughsoil. Dark brownish grey sandy silt. |                |      |
| 24801   | Layer               |         |           | 0.11      | Subsoil. Light orangish brown clayey sand. |                |      |
| 24802   | Layer               |         |           |           | Natural. Mid brownish orange sandy clay.   |                |      |
| 24803   | Unexcavated feature |         |           |           | Ditch. Modern ditch found in Trench 247    |                |      |

| <b>Trench 249</b>  |       |         |           |           |  |                |      |
|--|-------|---------|-----------|-----------|--|----------------|------|
| General description  |       |         |           |           |  | Orientation    | N-S  |
| Trench devoid of archaeology. Consists of ploughsoil and subsoil overlying natural geology of sandy clay with gravels. |       |         |           |           |  | Length (m)     | 30   |
|  |       |         |           |           |  | Width (m)      | 1.8  |
|  |       |         |           |           |  | Avg. depth (m) | 0.48 |
| Context No.  | Type  | Fill of | Width (m) | Depth (m) | Description                                | Finds          | Date |
| 24900  | Layer |         |           | 0.36      | Ploughsoil. Dark brownish grey sandy silt  |                |      |
| 24901  | Layer |         |           | 0.12      | Subsoil. Light orangish brown clayey sand. |                |      |
| 24902  | Layer |         |           |           | Natural. Mid brownish orange sandy clay.   |                |      |

| <b>Trench 250</b>  |  |  |  |  |  |                |  |
|--|--|--|--|--|--|----------------|--|
| General description  |  |  |  |  |  | Orientation    |  |
| Trench devoid of archaeology. Consists of ploughsoil and subsoil overlying natural geology of sandy clay with gravels. |  |  |  |  |  | Length (m)     |  |
|  |  |  |  |  |  | Width (m)      |  |
|  |  |  |  |  |  | Avg. depth (m) |  |

| Context No. | Type  | Fill of | Width (m) | Depth (m) | Description                                | Finds | Date |
|-------------|-------|---------|-----------|-----------|--|-------|------|
| 24900       | Layer |         |           | 0.36      | Ploughsoil. Dark brownish grey sandy silt. |       |      |
| 24901       | Layer |         |           | 0.12      | Subsoil. Light orangish brown clayey sand. |       |      |
| 24902       | 0.14  |         |           |           | Natural. Mid brownish orange sandy clay.   |       |      |

| <b>Trench 251</b>   |       |         |           |           |  |       |      |
|---|-------|---------|-----------|-----------|--|-------|------|
| General description   |       |         |           |           | Orientation                                | E-W   |      |
| Trench devoid of archaeology. Consists of ploughsoil and subsoil overlying natural geology of sandy clay with gravelly patches. |       |         |           |           | Length (m)                                 | 30    |      |
|   |       |         |           |           | Width (m)                                  | 1.8   |      |
|   |       |         |           |           | Avg. depth (m)                             | 0.48  |      |
| Context No.   | Type  | Fill of | Width (m) | Depth (m) | Description                                | Finds | Date |
| 24900   | Layer |         |           | 0.36      | Ploughsoil. Dark brownish grey sandy silt. |       |      |
| 24901   | Layer |         |           | 0.14      | Subsoil. Light orangish brown clayey sand. |       |      |
| 24902   | Layer |         |           |           | Natural. Mid brownish orange sandy clay.   |       |      |

| <b>Trench 270</b>   |       |         |           |           |  |         |      |
|---|-------|---------|-----------|-----------|--|---------|------|
| General description   |       |         |           |           | Orientation  | NNW-SSE |      |
| Trench devoid of archaeology. Trench consists of ploughsoil and made ground. Natural geology not exposed. |       |         |           |           | Length (m)   | 30      |      |
|   |       |         |           |           | Width (m)  | 2       |      |
|   |       |         |           |           | Avg. depth (m)   | 0.36    |      |
| Context No.   | Type  | Fill Of | Width (m) | Depth (m) | Description  | Finds   | Date |
| 27000   | Layer |         | 2         | 0.28      | Ploughsoil. Loose mid greyish brown silty clay.  |         |      |
| 27001   | Layer |         | 2         | 0.08      | Other Layer. Modern made ground. Loose brownish yellow silty sand, grey and orange mottling. |         |      |

| <b>Trench 271</b>   |       |         |           |           |   |         |      |
|---|-------|---------|-----------|-----------|---|---------|------|
| General description   |       |         |           |           | Orientation                                     | NEE-SWW |      |
| Trench devoid of archaeology. Trench consists of ploughsoil and made ground. Natural geology not exposed. |       |         |           |           | Length (m)                                      | 30      |      |
|   |       |         |           |           | Width (m)                                       | 2       |      |
|   |       |         |           |           | Avg. depth (m)                                  | 1.5     |      |
| Context No.   | Type  | Fill Of | Width (m) | Depth (m) | Description                                     | Finds   | Date |
| 27100   | Layer |         | 2         | 0.26      | Ploughsoil. Loose mid grayish brown silty clay. |         |      |



|       |       |  |   |      |   |  |  |
|-------|-------|--|---|------|---|--|--|
| 27101 | Layer |  | 2 | 0.68 | Other Layer. Modern made ground. Soft brownish yellow silty sand, grey and orange mottling. |  |  |
| 27102 | Layer |  |   |      | Other Layer. Made ground. Firm mid greyish blue clay.                                       |  |  |
| 27103 | Void  |  |   |      |   |  |  |

| Trench 272  |       |         |           |           |   |         |      |
|---|-------|---------|-----------|-----------|---|---------|------|
| General description   |       |         |           |           | Orientation   | NNW-SSE |      |
| Trench devoid of archaeology. Trench consists of ploughsoil and made ground. Natural geology not exposed. |       |         |           |           | Length (m)  | 30      |      |
|   |       |         |           |           | Width (m)   | 2       |      |
|   |       |         |           |           | Avg. depth (m)  | 0.92    |      |
| Context No.   | Type  | Fill Of | Width (m) | Depth (m) | Description   | Finds   | Date |
| 27200   | Layer |         | 2         | 0.24      | Ploughsoil. Loose mid greyish brown silty clay.       |         |      |
| 27201   | Layer |         |           | 0.66      | Other Layer. Made ground. Soft yellowish orange sand. |         |      |

| Trench 273  |       |         |           |           |   |         |      |
|---|-------|---------|-----------|-----------|---|---------|------|
| General description   |       |         |           |           | Orientation   | NEE-SWW |      |
| Trench devoid of archaeology. Trench consists of ploughsoil and made ground. Natural geology not exposed. |       |         |           |           | Length (m)  | 30      |      |
|   |       |         |           |           | Width (m)   | 2       |      |
|   |       |         |           |           | Avg. depth (m)  | 1.5     |      |
| Context No.   | Type  | Fill Of | Width (m) | Depth (m) | Description   | Finds   | Date |
| 27300   | Layer |         | 2         | 0.21      | Ploughsoil. Loose mid greyish brown silty clay.   |         |      |
| 27301   | Layer |         | 2         | 0.59      | Other Layer. Modern made ground. Soft brownish yellow silty sand, grey and orange mottling. |         |      |
| 27302   | Layer |         |           |           | Other Layer. Made ground. Firm mid reddish brown clayey gravels                             |         |      |

| Trench 274  |       |         |           |           |   |             |      |
|---|-------|---------|-----------|-----------|---|-------------|------|
| General description   |       |         |           |           | Orientation   | NNW-SSE     |      |
| Trench devoid of archaeology. Trench consists of ploughsoil and made ground. Natural geology not exposed. |       |         |           |           | Length (m)  | 30          |      |
|   |       |         |           |           | Width (m)   | 2           |      |
|   |       |         |           |           | Avg. depth (m)  | 0.95        |      |
| Context No.   | Type  | Fill Of | Width (m) | Depth (m) | Description   | Finds       | Date |
| 27400   | Layer |         |           | 0.28      | Ploughsoil. Loose mid greyish brown clayey silt.                      | Animal Bone |      |
| 27401   | Layer |         |           | 0.72      | Other Layer. Modern made up ground. Soft light Green and orange sand. |             |      |

| <b>Trench 275</b>   |       |         |           |           |   |       |         |
|---|-------|---------|-----------|-----------|---|-------|---------|
| General description   |       |         |           |           | Orientation   |       | NEE-SWW |
| Trench devoid of archaeology. Trench consists of ploughsoil and made ground. Natural geology not exposed. |       |         |           |           | Length (m)  |       | 30      |
|   |       |         |           |           | Width (m)   |       | 2       |
|   |       |         |           |           | Avg. depth (m)  |       | 1.5     |
| Context No.   | Type  | Fill Of | Width (m) | Depth (m) | Description   | Finds | Date    |
| 27500   | Layer |         |           | 0.34      | Ploughsoil. Loose mid greyish brown clayey silt                       |       |         |
| 27501   | Layer |         |           | 0.59      | Other Layer. Modern made up ground . Soft light yellowish green sand. |       |         |

| <b>Trench 276</b>   |       |         |           |           |   |       |      |
|---|-------|---------|-----------|-----------|---|-------|------|
| General description   |       |         |           |           | Orientation   |       | N-S  |
| Trench devoid of archaeology. Trench consists of ploughsoil and made ground. Natural geology not exposed. |       |         |           |           | Length (m)  |       | 30   |
|   |       |         |           |           | Width (m)   |       | 2    |
|   |       |         |           |           | Avg. depth (m)  |       | 0.75 |
| Context No.   | Type  | Fill Of | Width (m) | Depth (m) | Description   | Finds | Date |
| 27600   | Layer |         |           | 0.32      | Ploughsoil. Loose mid greyish brown clayey silt                                 |       |      |
| 27601   | Layer |         |           | 0.64      | Other Layer. Modern made up ground. Soft light yellowish green and orange sand. |       |      |

| <b>Trench 277</b>   |       |         |           |           |   |       |         |
|---|-------|---------|-----------|-----------|---|-------|---------|
| General description   |       |         |           |           | Orientation   |       | NEE-SWW |
| Trench consists of ploughsoil and made ground. Natural geology not exposed. |       |         |           |           | Length (m)  |       | 30      |
|   |       |         |           |           | Width (m)   |       | 2       |
|   |       |         |           |           | Avg. depth (m)  |       | 0.97    |
| Context No.   | Type  | Fill Of | Width (m) | Depth (m) | Description   | Finds | Date    |
| 27700   | Layer |         | 2         | 0.34      | Ploughsoil. Loose mid greyish brown silty clay.   |       |         |
| 27701   | Layer |         | 2         | 0.66      | Other Layer. Modern made ground. Soft brownish yellow silty sand, grey and orange mottling. |       |         |
| 27702   | Layer |         |           |           | Other Layer. Made up ground. Soft brownish orange sand.                                     |       |         |

| <b>Trench 278</b>   |  |  |  |  |             |  |         |
|---|--|--|--|--|-------------|--|---------|
| General description   |  |  |  |  | Orientation |  | NNW-SSE |
| Trench devoid of archaeology. Trench consists of ploughsoil and made ground. Natural geology not exposed. |  |  |  |  | Length (m)  |  | 30      |
|   |  |  |  |  | Width (m)   |  | 2       |

|             |       |         |           |           |   | Avg. depth (m) | 0.7  |
|-------------|-------|---------|-----------|-----------|---|----------------|------|
| Context No. | Type  | Fill Of | Width (m) | Depth (m) | Description   | Finds          | Date |
| 27800       | Layer |         | 2         | 0.28      | Ploughsoil. Loose mid greyish brown silt clay.  |                |      |
| 27801       | Layer |         | 2         | 0.68      | Other Layer. Modern made ground. Soft brownish yellow silty sand, grey and orange mottling. Frequent building refuse. |                |      |

| <b>Trench 279</b>   |       |         |           |           |  |         |      |
|---|-------|---------|-----------|-----------|--|---------|------|
| General description   |       |         |           |           | Orientation  | NEE-SWW |      |
| Trench devoid of archaeology. Trench consists of ploughsoil and made ground. Natural geology not exposed. |       |         |           |           | Length (m)   | 30      |      |
|   |       |         |           |           | Width (m)  | 2       |      |
|   |       |         |           |           | Avg. depth (m)   | 1.5     |      |
| Context No.   | Type  | Fill Of | Width (m) | Depth (m) | Description  | Finds   | Date |
| 27900   | Layer |         | 2         | 0.32      | Ploughsoil. Loose mid greyish brown silty clay.  |         |      |
| 27901   | Layer |         | 2         | 0.62      | Other Layer. Made up ground. Soft light Brownish orange sandy gravel and dark greyish brown clays. |         |      |
| 27902   | Void  |         |           |           |  |         |      |
| 27903   | Void  |         |           |           |  |         |      |
| 27904   | Layer |         |           |           | Other Layer. Made up ground. Loose brownish orange sand and concrete rubble.                       |         |      |

| <b>Trench 280</b>  |       |         |           |           |   |         |      |
|--|-------|---------|-----------|-----------|---|---------|------|
| General description  |       |         |           |           | Orientation   | NNE-SSW |      |
| Trench revealed the edge of modern quarrying. Trench consists of ploughsoil and made ground. Natural geology partially exposed as sandy gravels. |       |         |           |           | Length (m)  | 30      |      |
|  |       |         |           |           | Width (m)   | 2       |      |
|  |       |         |           |           | Avg. depth (m)  | 0.8     |      |
| Context No.  | Type  | Fill Of | Width (m) | Depth (m) | Description   | Finds   | Date |
| 28000  | Layer |         |           | 0.61      | Ploughsoil. Loose mid greyish brown clayey silt.                              |         |      |
| 28001  | Layer |         |           | 0.42      | Other Layer. Made up ground . Soft dark greyish brown clayey silt and gravel. |         |      |
| 28002  | Layer |         |           | 0.26      | Natural. Firm mid reddish brown sandy clay.                                   |         |      |

| <b>Trench 281</b>   |  |  |  |  |             |         |  |
|---------------------|--|--|--|--|-------------|---------|--|
| General description |  |  |  |  | Orientation | ENE-WSW |  |
|                     |  |  |  |  | Length (m)  | 30      |  |

| Trench devoid of archaeology. Trench consists of ploughsoil and madeground. Natural geology not exposed. |       |         |           |           |  | Width (m)      | 2    |
|--|-------|---------|-----------|-----------|--|----------------|------|
|  |       |         |           |           |  | Avg. depth (m) | 0.65 |
| Context No.  | Type  | Fill Of | Width (m) | Depth (m) | Description  | Finds          | Date |
| 28100  | Layer |         |           | 0.36      | Ploughsoil. Loose mid greyish brown clayey silt                  |                |      |
| 28101  | Void  |         |           |           |  |                |      |
| 28102  | Layer |         |           | 0.36      | Other Layer. Made up ground. Soft dark brownish grey sandy clay. |                |      |
| 28103  | Layer |         |           | 0.35      | Natural. Compact mid reddish brown sandy gravel.                 |                |      |

| Trench 282  |       |         |           |           |  |                |         |
|---|-------|---------|-----------|-----------|--|----------------|---------|
| General description   |       |         |           |           |  | Orientation    | NNE-SSW |
| Trench devoid of archaeology. Trench consists of ploughsoil overlying a sandy clay natural. |       |         |           |           |  | Length (m)     | 30      |
|   |       |         |           |           |  | Width (m)      | 2       |
|   |       |         |           |           |  | Avg. depth (m) | 0.5     |
| Context No.   | Type  | Fill Of | Width (m) | Depth (m) | Description                                      | Finds          | Date    |
| 28200   | Layer |         |           | 0.37      | Ploughsoil. Loose mid greyish brown clayey silt. |                |         |
| 28201   | Layer |         |           |           | Natural. Firm mid reddish brown sandy clay.      |                |         |

| Trench 283   |       |         |           |           |   |                |         |
|--|-------|---------|-----------|-----------|---|----------------|---------|
| General description  |       |         |           |           |   | Orientation    | NEE-SWW |
| Trench revealed two ditches. Trench consists of ploughsoil and subsoil overlying a sandy clay natural. |       |         |           |           |   | Length (m)     | 30      |
|  |       |         |           |           |   | Width (m)      | 2       |
|  |       |         |           |           |   | Avg. depth (m) | 0.66    |
| Context No.  | Type  | Fill Of | Width (m) | Depth (m) | Description   | Finds          | Date    |
| 28300  | Layer |         |           | 0.36      | Ploughsoil. Loose mid greyish brown clayey silt.                                |                |         |
| 28301  | Layer |         |           | 0.26      | Subsoil. Firm mid brownish grey clayey silt.                                    |                |         |
| 28302  | Layer |         |           |           | Natural. Firm mid reddish brown sandy clay with gravels.                        |                |         |
| 28303  | Cut   |         | 1.15      | 0.36      | Ditch. Linear N-S, Concave base.  | Pot            | Med     |
| 28304  | Fill  | 28303   | 1.15      | 0.36      | Primary Fill. Hard mid reddish brown clayey gravel fill.                        | Pot            | Roman   |
| 28305  | Cut   |         | 0.71      | 0.63+     | Ditch. Steep sides very vertical. Base not reached within 1 metre.              |                |         |
| 28306  | Fill  | 28305   |           | 0.63      | Primary Fill. Soft dark brownish grey silt. Not fully exc due to 1m limitation. | CBM            | C17-18  |

| Trench 284 |  |  |  |  |  |  |  |
|------------|--|--|--|--|--|--|--|
|------------|--|--|--|--|--|--|--|

| General description  |       |         |           |           |  | Orientation  | NNE-SSW |
|--|-------|---------|-----------|-----------|--|--|---------|
| Trench revealed three ditches and one pit. Trench consists of ploughsoil and subsoil overlying a sandy clay natural. |       |         |           |           |  | Length (m)   | 30      |
|  |       |         |           |           |  | Width (m)  | 2       |
|  |       |         |           |           |  | Avg. depth (m)   | 0.5     |
| Context No.  | Type  | Fill Of | Width (m) | Depth (m) | Description  | Finds  | Date    |
| 28400  | Layer |         |           | 0.36      | Ploughsoil. Loose mid brownish grey sandy silt.  |  |         |
| 28401  | Layer |         |           | 0.25      | Subsoil. Soft mid brownish grey clayey silt  |  |         |
| 28402  | Layer |         |           |           | Natural. Firm mid reddish brown sandy clay   |  |         |
| 28403  | Cut   |         | 0.86      | 0.37      | Natural Feature. Sub-circular tree-throw with concave base and irregular sides. Dark greyish brown sandy clay with frequent small sub rounded stone inclusions.  |  |         |
| 28404  | Cut   |         | 0.94      | 0.21      | Ditch. Linear ditch running NE-SW.   |  |         |
| 28405  | Fill  | 28404   | 0.94      | 0.21      | Primary Fill. Dark greyish brown sandy clay with occ. small sub-rounded stones.  | Slag   |         |
| 28406  | Cut   |         | 0.7       | 0.15      | Pit. sub-circular charcoal rich pit, shallow sides with steeper break of slope, against W bulk   |  |         |
| 28407  | Fill  | 28406   | 0.7       | 0.15      | Primary Fill. Soft dark grayish brown silty clay with frequent small charcoal throughout, occasional small flints and occasional small flecks of burnt clay. <S27>.  | Slag   |         |
| 28408  | Cut   |         | 0.5       | 0.4       | Ditch. Possible ditch running nnw-sse, slightly irregular rounded base moderate steep sides  |  |         |
| 28409  | Fill  | 28408   | 0.5       | 0.4       | Secondary Fill. Sedimentary infill, light orangey grey very fine clayey silt, firm, rare small pebbles   | Pot  | Med     |
| 28410  | Cut   |         | 2.84+     | 0.4+      | Ditch. Ditch not fully excavated due to depth and width. Possible relationship with another ditch running parallel. SE/NW. Mod sloping side on SW back with a gentle slope on NE bank. Base not reached.                                       |  |         |
| 28411  | Fill  | 28410   | 1.35      | 0.4       | Secondary Fill. Mid slightly greyish brown silty clay with occasional small flints and pebbles/large rounded flints and pebbles at base. Occasional charcoal flecks especially at interface with natural. Infrequent potsherds and animal bone | Pot<br>Med,<br>CBM<br>Pmed,<br>Slag<br>incl tap<br>slag,<br>Animal<br>bone | Pmed?   |

|       |      |       |      |     |  |                              |     |
|-------|------|-------|------|-----|--|------------------------------|-----|
|       |      |       |      |     | concentrated near top of fill. Rare Cbm tile.  |                              |     |
| 28412 | Fill | 28410 | 0.77 | 0.4 | Secondary Fill. Mid yellowish brown with grey mottling. Mod compact sandy clay. Occ small sub- angular stone inclusions  | Pot, Slag                    | Med |
| 28413 | Fill | 28410 | 0.66 | 0.4 | Primary Fill. Dark brownish grey mod compact sandy clay with frequent charcoal flecks and occ. small sub-angular stones. | Pot, Slag, Stone Quern frags | Med |

| Trench 285   |       |         |           |           |   |                          |         |
|--|-------|---------|-----------|-----------|---|--------------------------|---------|
| General description  |       |         |           |           | Orientation   |                          | NEE-SWW |
| Trench revealed one ditch. Trench consists of ploughsoil and subsoil overlying a sandy clay natural. |       |         |           |           | Length (m)  |                          | 30      |
|  |       |         |           |           | Width (m)   |                          | 2       |
|  |       |         |           |           | Avg. depth (m)  |                          | 0.3     |
| Context No.  | Type  | Fill Of | Width (m) | Depth (m) | Description   | Finds                    | Date    |
| 28500  | Layer |         |           | 0.26      | Ploughsoil. Loose mid greyish brown clayey silt.  |                          |         |
| 28501  | Layer |         |           | 0.08      | Subsoil. Soft dark greyish brown silty clay.  |                          |         |
| 28502  | Layer |         |           |           | Natural. Firm mid reddish brown sandy clay.   |                          |         |
| 28503  | Cut   |         | 1.15      | 0.3       | Ditch. Linear ditch running NNW-SSE with moderate concave sides and a moderately flat base. |                          |         |
| 28504  | Fill  | 28503   | 1.15      | 0.3       | Primary Fill. Firm mid orange-brown silty-clay with occasional charcoal.                    | Pot, slag, Stone (Quern) | Med     |

| Trench 286  |       |         |           |           |  |       |         |
|---|-------|---------|-----------|-----------|--|-------|---------|
| General description   |       |         |           |           | Orientation                                      |       | NNW-SSE |
| Trench devoid of archaeology. Trench consists of ploughsoil and subsoil overlying a sandy clay natural. |       |         |           |           | Length (m)                                       |       | 30      |
|   |       |         |           |           | Width (m)  |       | 2       |
|   |       |         |           |           | Avg. depth (m)                                   |       | 0.5     |
| Context No.   | Type  | Fill Of | Width (m) | Depth (m) | Description                                      | Finds | Date    |
| 28600   | Layer |         |           | 0.35      | Ploughsoil. Loose mid greyish brown clayey silt. |       |         |
| 28601   | Layer |         |           | 0.26      | Subsoil. Soft light greyish brown silty clay.    |       |         |
| 28602   | Layer |         |           |           | Natural. Firm mid reddish brown sandy clay.      |       |         |

| Trench 287          |  |  |  |  |             |  |         |
|---------------------|--|--|--|--|-------------|--|---------|
| General description |  |  |  |  | Orientation |  | NEE-SWW |

| Trench devoid of archaeology. Trench consists of ploughsoil and subsoil overlying a sandy clay natural. |       |         |           |           |  | Length (m)     | 30   |
|---|-------|---------|-----------|-----------|--|----------------|------|
|   |       |         |           |           |  | Width (m)      | 2    |
|   |       |         |           |           |  | Avg. depth (m) | 0.35 |
| Context No.   | Type  | Fill Of | Width (m) | Depth (m) | Description                                      | Finds          | Date |
| 28700   | Layer |         |           | 0.26      | Ploughsoil. Loose mid greyish brown clayey silt. |                |      |
| 28701   | Layer |         |           | 0.12      | Subsoil. Soft dark greyish brown silty clay.     |                |      |
| 28702   | Layer |         |           |           | Natural. Firm mid reddish brown sandy clay.      |                |      |

| <b>Trench 288</b>   |       |         |           |           |  |                |         |
|---|-------|---------|-----------|-----------|--|----------------|---------|
| General description   |       |         |           |           |  | Orientation    | NNW-SSE |
| Trench devoid of archaeology. Trench consists of ploughsoil and subsoil overlying a silty clay natural. |       |         |           |           |  | Length (m)     | 30      |
|   |       |         |           |           |  | Width (m)      | 2       |
|   |       |         |           |           |  | Avg. depth (m) | 0.3     |
| Context No.   | Type  | Fill Of | Width (m) | Depth (m) | Description                                      | Finds          | Date    |
| 28800   | Layer |         |           | 0.22      | Ploughsoil. Loose mid greyish brown clayey silt. |                |         |
| 28801   | Layer |         |           | 0.11      | Subsoil. Soft dark greyish brown silty clay.     |                |         |
| 28802   | Layer |         |           |           | Natural. Firm mid reddish brown sandy clay .     |                |         |

| <b>Trench 289</b>  |       |         |           |           |  |                |       |
|--|-------|---------|-----------|-----------|--|----------------|-------|
| General description  |       |         |           |           |  | Orientation    | NE-SW |
| Trench devoid of archaeology. Consisted of ploughsoil and subsoil overlying the natural geology. |       |         |           |           |  | Length (m)     | 30    |
|  |       |         |           |           |  | Width (m)      | 1.8   |
|  |       |         |           |           |  | Avg. depth (m) | 0.42  |
| Context No.  | Type  | Fill Of | Width (m) | Depth (m) | Description  | Finds          | Date  |
| 28900  | Layer |         |           | 0.3       | Ploughsoil. Dark greyish brown, silty clay. Contains some gravels, pebbles and limestones. |                |       |
| 28901  | Layer |         |           | 0.1       | Subsoil. Mid brown, silty clay. Includes some gravels, pebbles and limestones.             |                |       |
| 28902  | Layer |         |           |           | Natural. Light brown, sandy clay. Includes some gravels and pebbles.                       |                |       |

| <b>Trench 290</b>  |  |  |  |  |  |                |      |
|--|--|--|--|--|--|----------------|------|
| General description  |  |  |  |  |  | Orientation    | N-S  |
| Trench devoid of archaeology. Consisted of ploughsoil and subsoil overlying the natural geology. |  |  |  |  |  | Length (m)     | 30   |
|  |  |  |  |  |  | Width (m)      | 1.8  |
|  |  |  |  |  |  | Avg. depth (m) | 0.48 |

| Context No. | Type  | Fill Of | Width (m) | Depth (m) | Description   | Finds | Date |
|-------------|-------|---------|-----------|-----------|---|-------|------|
| 29000       | Layer |         |           | 0.3       | Ploughsoil. Dark greyish brown, silty clay. Contains a lot of sub-rounded stones and pebbles.                         |       |      |
| 29001       | Layer |         |           | 0.16      | Subsoil. Mid brown, silty sand. Includes also some pebbles and limestones.  |       |      |
| 29002       | Layer |         |           |           | Natural. Light yellowish brown, sandy silt. Includes some patches of pebbles' gravels as result of alluvial activity. |       |      |

### Trench 291

| General description  |       |         |           |           | Orientation  | N-S   |      |
|--|-------|---------|-----------|-----------|--|-------|------|
| Trench devoid of archaeology. Consisted of ploughsoil and subsoil covering a sandy clay natural. |       |         |           |           | Length (m)   | 30    |      |
|  |       |         |           |           | Width (m)  | 1.8   |      |
|  |       |         |           |           | Avg. depth (m)   | 0.48  |      |
| Context No.  | Type  | Fill Of | Width (m) | Depth (m) | Description  | Finds | Date |
| 29100  | Layer |         |           | 0.32      | Ploughsoil. Dark greyish brown, silty clay. Includes some gravels, pebbles and limestones. |       |      |
| 29101  | Layer |         |           | 0.15      | Subsoil. Mid brown, silty clay. Contains some pebbles and limestones.                      |       |      |
| 29102  | Layer |         |           |           | Natural. Sandy clay gravel   |       |      |

### Trench 292

| General description   |       |         |           |           | Orientation  | NE-SW |      |
|---|-------|---------|-----------|-----------|--|-------|------|
| Trench devoid of archaeology. Consisted of ploughsoil and subsoil covering a sand and gravel natural geology. |       |         |           |           | Length (m)   | 30    |      |
|   |       |         |           |           | Width (m)  | 1.8   |      |
|   |       |         |           |           | Avg. depth (m)   | 0.48  |      |
| Context No.   | Type  | Fill Of | Width (m) | Depth (m) | Description  | Finds | Date |
| 29200   | Layer |         |           | 0.35      | Ploughsoil. Dark greyish brown, silty clay. Contains some gravels, pebbles and limestones. |       |      |
| 29201   | Layer |         |           | 0.13      | Subsoil. Mid reddish brown, sandy clay. Includes some sub-rounded and pebbles' gravels.    |       |      |
| 29202   | Layer |         |           |           | Natural. Light orangey yellow, sandy sand. Includes sub-rounded and pebbles' gravels.      |       |      |

### Trench 293

| General description   |  |  |  |  | Orientation    | NW-SE |
|---|--|--|--|--|----------------|-------|
| Trench devoid of archaeology. Consisted of ploughsoil and subsoil covering a sand and gravel natural geology. |  |  |  |  | Length (m)     | 30    |
|   |  |  |  |  | Width (m)      | 1.8   |
|   |  |  |  |  | Avg. depth (m) | 0.42  |



| Context No. | Type  | Fill Of | Width (m) | Depth (m) | Description                             | Finds | Date |
|-------------|-------|---------|-----------|-----------|---|-------|------|
| 29300       | Layer |         |           | 0.3       | Ploughsoil. Dark brown. silty clay      |       |      |
| 29301       | Layer |         |           | 0.12      | Subsoil. Mid orangey brown silty clay   |       |      |
| 29302       | Layer |         |           |           | Natural. Light reddish brown sandy clay |       |      |

#### Trench 294

| General description   |       |         |           |           | Orientation  | NE-SW |      |
|---|-------|---------|-----------|-----------|--|-------|------|
| Trench devoid of archaeology. Consisted of ploughsoil and subsoil covering a sand and gravel natural geology. |       |         |           |           | Length (m)   | 30    |      |
|   |       |         |           |           | Width (m)  | 1.8   |      |
|   |       |         |           |           | Avg. depth (m)   | 0.42  |      |
| Context No.   | Type  | Fill Of | Width (m) | Depth (m) | Description  | Finds | Date |
| 29400   | Layer |         |           | 0.3       | Ploughsoil. Dark greyish brown. Silty clay. Loose texture.   |       |      |
| 29401   | Layer |         |           | 0.15      | Subsoil. Mid brown. Silty clay. Friable texture.   |       |      |
| 29402   | Layer |         |           |           | Natural. Light yellowish orange. Sandy clay with also so many rounded gravels' patches. Loose texture. |       |      |

#### Trench 295

| General description   |       |         |           |           | Orientation  | NE-SW |      |
|---|-------|---------|-----------|-----------|--|-------|------|
| Trench devoid of archaeology. Consisted of ploughsoil and subsoil covering a sand and gravel natural geology. |       |         |           |           | Length (m)   | 30    |      |
|   |       |         |           |           | Width (m)  | 1.8   |      |
|   |       |         |           |           | Avg. depth (m)   | 0.41  |      |
| Context No.   | Type  | Fill Of | Width (m) | Depth (m) | Description  | Finds | Date |
| 29500   | Layer |         |           | 0.3       | Ploughsoil. Dark greyish brown. Silty clay. Friable texture.   |       |      |
| 29501   | Layer |         |           | 0.1       | Subsoil. Mid orangey brown. Silty clay. Friable texture.   |       |      |
| 29502   | Layer |         |           |           | Natural. Light orangey brown. Sandy clay, with some rounded gravels' patches (pebbles) as result of the alluvial deposition. |       |      |

#### Trench 296

| General description   |      |         |           |           | Orientation    | NE-SW |      |
|---|------|---------|-----------|-----------|----------------|-------|------|
| Trench devoid of archaeology. Consisted of ploughsoil and subsoil covering a sand and gravel natural geology. |      |         |           |           | Length (m)     | 30    |      |
|   |      |         |           |           | Width (m)      | 1.8   |      |
|   |      |         |           |           | Avg. depth (m) | 0.41  |      |
| Context No.   | Type | Fill Of | Width (m) | Depth (m) | Description    | Finds | Date |

|       |       |  |  |     |  |  |  |
|-------|-------|--|--|-----|--|--|--|
| 29600 | Layer |  |  | 0.3 | Ploughsoil. Dark brown silty clay.       |  |  |
| 29601 | Layer |  |  | 0.1 | Subsoil. Light greyish brown sandy silt  |  |  |
| 29602 | Layer |  |  |     | Natural. Light greyish yellow sand clay. |  |  |

| Trench 297  |       |         |           |           |   |       |       |
|---|-------|---------|-----------|-----------|---|-------|-------|
| General description   |       |         |           |           | Orientation   |       | NW-SE |
| Trench devoid of archaeology. Consisted of ploughsoil and subsoil covering a sand and gravel natural geology. There is one natural feature towards the north. |       |         |           |           | Length (m)  |       | 30    |
|   |       |         |           |           | Width (m)   |       | 1.8   |
|   |       |         |           |           | Avg. depth (m)  |       | 0.38  |
| Context No.   | Type  | Fill Of | Width (m) | Depth (m) | Description   | Finds | Date  |
| 29700   | Layer |         | 1.8       | 0.3       | Ploughsoil. Dark greyish brown.   |       |       |
| 29701   | Layer |         | 1.8       | 0.08      | Subsoil. Mid brown. Silty clay.   |       |       |
| 29702   | Layer |         | 1.8       |           | Natural. Light orangey brown. Sandy clay with some patches of pebbles   |       |       |
| 29703   | Cut   |         |           |           | Natural Feature. It seems to be a natural cut (erosion) filled by some gravelly soil (sub-rounded gravels and pebbles) as a result of some alluvial deposition. |       |       |

| Trench 298   |       |         |           |           |  |       |       |
|--|-------|---------|-----------|-----------|--|-------|-------|
| General description  |       |         |           |           | Orientation                                      |       | NW-SE |
| Trench consists of ploughsoil overlying a sandy clay natural. Trench revealed one ENE-WSW ditch. |       |         |           |           | Length (m)                                       |       | 30    |
|  |       |         |           |           | Width (m)  |       | 1.8   |
|  |       |         |           |           | Avg. depth (m)                                   |       | 0.38  |
| Context No.  | Type  | Fill Of | Width (m) | Depth (m) | Description                                      | Finds | Date  |
| 29800  | Layer |         | 1.8       | 0.38      | Ploughsoil. Dark brown/grey clayey silt.         |       |       |
| 29801  | Layer |         | 1.8       |           | Natural. Pale yellow/grey clay                   |       |       |
| 29802  | Cut   |         | 1.27      | 0.52+     | Ditch- not bottomed.                             |       |       |
| 29803  | Fill  | 29802   | 0.8       | 0.25      | Deliberate Backfill. Dark grey/brown clayey silt |       |       |
| 29804  | Fill  | 29802   | 1.27      | 0.29      | Deliberate Backfill. Dark brown/grey clayey silt |       |       |

| Trench 299  |  |  |  |  |             |  |       |
|---|--|--|--|--|-------------|--|-------|
| General description   |  |  |  |  | Orientation |  | NE-SW |
| Trench devoid of archaeology. Consisted of ploughsoil and subsoil covering a sand and gravel natural geology. |  |  |  |  | Length (m)  |  | 30    |
|   |  |  |  |  | Width (m)   |  | 1.8   |

|             |       |         |           |           |  | Avg. depth (m) | 0.4  |
|-------------|-------|---------|-----------|-----------|--|----------------|------|
| Context No. | Type  | Fill Of | Width (m) | Depth (m) | Description  | Finds          | Date |
| 29900       | Layer |         |           | 0.3       | Ploughsoil. Dark greyish brown, silty clay. Contains some gravels, pebbles and limestones. |                |      |
| 29901       | Layer |         |           | 0.1       | Subsoil. Mid brown, silty clay. Includes some gravels, pebbles and limestones.             |                |      |
| 29902       | Layer |         |           |           | Natural. Pale reddish brown, sandy clay. Includes some pebble patches.                     |                |      |

| <b>Trench 300</b>  |                     |         |           |           |   |              |       |
|--|---------------------|---------|-----------|-----------|---|--------------|-------|
| General description  |                     |         |           |           | Orientation   |              | NW-SE |
| Trench consists of ploughsoil and subsoil covering a sandy clay natural. Trench revealed one unexcavated ditch which has been excavated in Trenches 298 and 303. |                     |         |           |           | Length (m)  |              | 30    |
|  |                     |         |           |           | Width (m)   |              | 1.8   |
|  |                     |         |           |           | Avg. depth (m)  |              | 0.42  |
| Context No.  | Type                | Fill Of | Width (m) | Depth (m) | Description   | Finds        | Date  |
| 30000  | Layer               |         | 1.8       | 0.3       | Ploughsoil. Dark greyish brown, silty clay.   |              |       |
| 30001  | Layer               |         | 1.8       | 0.12      | Subsoil. Mid orangey brown, silty clay.   |              |       |
| 30002  | Layer               |         | 1.8       |           | Natural. Mid reddish brown, sandy clay.   |              |       |
| 30003  | Unexcavated feature |         | 1.26      |           | Ditch. Field boundary that belongs to a late 19th or early 20th century plot of land. It's the same boundary that we have already recorded in Trenches 298 and 303. | Fe strip/bar |       |

| <b>Trench 301</b>   |       |         |           |           |   |       |       |
|---|-------|---------|-----------|-----------|---|-------|-------|
| General description   |       |         |           |           | Orientation   |       | NE-SW |
| Trench devoid of archaeology. Consisted of ploughsoil and subsoil covering a sand and gravel natural geology. |       |         |           |           | Length (m)  |       | 30    |
|   |       |         |           |           | Width (m)   |       | 1.8   |
|   |       |         |           |           | Avg. depth (m)  |       | 0.38  |
| Context No.   | Type  | Fill Of | Width (m) | Depth (m) | Description   | Finds | Date  |
| 30100   | Layer |         |           | 0.3       | Ploughsoil. Dark greyish brown, silty clay. Includes some gravels, pebbles and limestones.                |       |       |
| 30101   | Layer |         |           | 0.08      | Subsoil. Mid reddish brown. Includes also some limestones and pebbles.                                    |       |       |
| 30102   | Layer |         |           |           | Natural. Light brown, sandy clay. Contains some gravelly patches (mainly sub-rounded stones and pebbles). |       |       |

| <b>Trench 302</b>   |  |  |  |  |             |  |       |
|---------------------|--|--|--|--|-------------|--|-------|
| General description |  |  |  |  | Orientation |  | NW-SE |

| Trench devoid of archaeology. Consisted of ploughsoil and subsoil covering a sand and gravel natural geology. |       |         |           |           |  | Length (m)     | 30   |
|---|-------|---------|-----------|-----------|--|----------------|------|
|   |       |         |           |           |  | Width (m)      | 1.8  |
|   |       |         |           |           |  | Avg. depth (m) | 0.38 |
| Context No.   | Type  | Fill Of | Width (m) | Depth (m) | Description  | Finds          | Date |
| 30200   | Layer |         |           | 0.3       | Ploughsoil. Dark greyish brown layer. Loose texture. |                |      |
| 30201   | Layer |         |           | 0.08      | Subsoil. Mid brown. Friable texture.                 |                |      |
| 30202   | Layer |         |           |           | Natural. Mid orangey brown. Sandy clay.              |                |      |

| <b>Trench 303</b>  |       |         |           |           |   |                  |       |
|--|-------|---------|-----------|-----------|---|------------------|-------|
| General description<br>Trench revealed a historic boundary ditch at the eastern end. It consisted of ploughsoil and subsoil overlying the natural geology. |       |         |           |           |   | Orientation      | NE-SW |
|  |       |         |           |           |   | Length (m)       | 30    |
|  |       |         |           |           |   | Width (m)        | 1.8   |
|  |       |         |           |           |   | Avg. depth (m)   | 0.35  |
| Context No.  | Type  | Fill Of | Width (m) | Depth (m) | Description   | Finds            | Date  |
| 30300  | Layer |         |           | 0.3       | Ploughsoil. Dark greyish brown layer. Loose texture.          |                  |       |
| 30301  | Layer |         |           | 0.05      | Subsoil. Mid greyish brown. Quite compacted texture.          |                  |       |
| 30302  | Layer |         |           |           | Natural. Light brown natural. Clayey clay. Compacted texture. |                  |       |
| 30303  | Cut   |         | 2.38      | 0.54      | Ditch. Modern ditch   |                  |       |
| 30304  | Fill  | 30303   | 1.51      | 0.34      | Secondary Fill. Mid blackish brown soft clayey silt           | CBM, Animal bone | Pmed  |
| 30305  | Fill  | 30303   | 2.38      | 0.32      | Secondary Fill. Mid yellowish brown soft clayey silt          |                  |       |
| 30306  | Fill  | 30303   | 0.48      | 0.18      | Secondary Fill. Mid blackish brown soft clayey silt           |                  |       |

### B.1 Prehistoric Pottery

By Alex Davies

#### Introduction

- B.1.1 Some 75 sherds weighing 200g were found over 25 contexts in 21 trenches (Table 1). The assemblage is poorly preserved with a mean sherd weight of just 2.6g, suggesting that the material has been subject to a significant degree of fragmentation and dispersal after initial discard. The material in many of the contexts could be residual or intrusive.
- B.1.2 There are very few diagnostic sherds. There are only two rims, one very small, and none of the material is decorated. Spot-dating is almost entirely based on fabrics. Almost all the material is flint tempered, with the exception of two sherds that contain only quartz sand. The spot-date ranges for most of the contexts are broad, reflecting the continuing use of flint as a tempering agent in the region over long periods of time (Evans *et al.* 2016, 70, 105, 160, 379-80), and the small and fragmentary nature of the assemblage dominated by body sherds.

#### Methodology

- B.1.3 Pottery from each context was scanned, with spot dates given based on the latest material present. Fabrics were recorded in order of their approximate frequency in any one context. The two most common inclusion types were noted, using the following fabric codes:
- FI – Flint
  - Qs – Quartz sand
- B.1.4 The grade of the fabric was also recorded with a number suffix, ranging from 1 (fine) to 4 (very coarse).

#### Early Neolithic

- B.1.5 Two contexts (8803 and 8804) have been spot dated to the early Neolithic (probably Plain Bowl) on the basis of their poorly sorted coarse flint fabrics that stands out from the well sorted later prehistoric material from this site and the wider scheme. Three further contexts (9610, 7206 and 6104) produced sherds in a similar fabric, but the spot dates are less certain, as the sherds are very small and abraded; even if they are this date, they could be residual in later contexts.

#### Middle and late Bronze Age

- B.1.6 None of the material was diagnostically middle Bronze Age, although many of the flint-tempered body sherds could be of this date.
- B.1.7 Pottery from context 9805 is probably middle or late Bronze Age in date on the basis of its coarse fabric, although this date is very tentative.
- B.1.8 At least two contexts contained pottery of probable late Bronze Age date (1705 and 18403). Context 1705 contained the only diagnostic rim sherd, and this was incurving, probably from a late Bronze Age hook-rim jar. The pottery in context 18403 is spot

dated to the late Bronze Age/iron Age, but a late Bronze Age perforated clay slab was also found in the context, showing its late Bronze Age date.

- B.1.9 A slight shoulder was found in context 9608 that probably belongs to a late Bronze Age or Iron Age vessel, although this is tentative. A shoulder or angle that was fingertipped was found in 22106 that is late Bronze Age or early Iron Age.

### Iron Age

- B.1.10 No certain Iron Age pottery was found, but contexts 7102 and 10205 have been tentatively spot-dated to the Iron Age, as these were the only sherds that did not contain flint. Sand slowly replaced flint in pottery fabrics through the Iron Age in the region, and any contexts containing sandy fabrics are perhaps more likely to have been Iron Age in date rather than Bronze Age (Mucking: Brudenell 2016a, 160; 2016b, 380; South Hornchurch: Harrison 2000, 337–8). However, quantities recovered from this evaluation are very small, making such comments tentative. Contexts containing sand and flint are 9303, 10605, 14703 and 14711.

- B.1.11 A complete absence of glauconitic sand makes a middle Iron Age presence unlikely. If any of the material is indeed Iron Age, it is more likely that this is early Iron Age in date.

### Retention

- B.1.12 The pottery has future research value and should all be retained.

| Context | Count | Weight (g) | Fabric                        | Spot date           | Comment                              |
|---------|-------|------------|-------------------------------|---------------------|--------------------------------------|
| 1705    | 2     | 6          | FI2                           | LBA                 | Incurving rim. Could be IA?          |
| 1707    | 1     | 3          | FI2                           | MBA-IA              |                                      |
| 4206    | 1     | 1          | FI2                           | MBA-IA              | Very small and abraded               |
| 4406    | 3     | 1          | FI2                           | MBA-IA              | Very small and abraded               |
| 6104    | 2     | 8          | FI3 (poorly sorted);<br>QsFI2 | E Neo?              | Poss MBA-IA                          |
| 6106    | 2     | 1          | QsFI2                         | MBA-IA              | Very small. Rim                      |
| 7102    | 1     | 4          | Qs2                           | IA?                 | Very abraded                         |
| 7206    | 1     | 1          | FI3 (poorly sorted)           | E Neo, or<br>MBA-IA | Very abraded                         |
| 7704    | 4     | 2          | FI2                           | MBA-IA              |                                      |
| 8803    | 3     | 8          | FI3 (poorly sorted)           | E Neo               |                                      |
| 8804    | 1     | 4          | FI3 (poorly sorted)           | E Neo               |                                      |
| 9303    | 11    | 23         | QsFI2                         | MBA-IA              | Probably IA? Base                    |
| 9608    | 3     | 2          | FI2                           | LBA/IA?             | Slight shoulder? Not very diagnostic |
| 9610    | 2     | 2          | FI3                           | E Neo or<br>MBA-IA  | Very small and abraded               |
| 9805    | 3     | 12         | FI3                           | MBA-IA              | Base. Coarse, more likely M/LBA      |
| 10004   | 4     | 16         | FI2; FI3                      | MBA-IA              |                                      |
| 10205   | 1     | 3          | Qs2                           | IA?                 | Very abraded. Sample 22              |
| 10605   | 1     | 3          | FIQs2                         | MBA-IA              | Poss IA?                             |
| 14703   | 1     | 1          | FIQs2                         | MBA-IA              | Very abraded. Poss IA?               |

| <b>Context</b> | <b>Count</b> | <b>Weight (g)</b> | <b>Fabric</b> | <b>Spot date</b> | <b>Comment</b>                         |
|----------------|--------------|-------------------|---------------|------------------|--|
| 14711          | 1            | 3                 | QsFI2         | MBA-IA           | Very abraded. Poss IA?                 |
| 17604          | 10           | 41                | FI3; FI2      | MBA-IA           |  |
| 18403          | 1            | 13                | FI2           | LBA/IA           | LBA - context contains perforated slab |
| 22106          | 7            | 23                | FI2           | LBA-EIA          | Shoulder/angle and fingertipping       |
| 24304          | 6            | 4                 | FI2           | MBA-IA           |  |
| <b>Total</b>   | <b>75</b>    | <b>200g</b>       |               |                  |  |

Table 1: Prehistoric pottery assemblage

## B.2 Late Iron Age and Roman Pottery

By Edward Biddulph

### Introduction

B.2.1 Some 222 sherds of late Iron Age and Roman pottery, weighing 3147g, were recovered from the evaluation (Table 2). Context groups were sorted into fabrics and each fabric group quantified by sherd count and weight in grams. Fabrics were assigned codes devised by the Essex County Council Field Archaeology Unit (cf. Biddulph *et al.* 2015). Forms were identified by rim and quantified by minimum number of vessels (MV) and estimated vessel equivalents (EVE), which measure the surviving percentage of the rim circumference (thus, 0.25 EVE equals 25%). Forms codes were taken from Going's Chelmsford typology (Going 1987). Forms and fabrics are quantified in Tables 2 and 3.

| Fabric       | Description                             | Count      | Weight (g)  | MV        | EVE         |
|--------------|---|------------|-------------|-----------|-------------|
| ABAET        | South Spanish amphora fabric (BAT AM 1) | 1          | 44          |           |             |
| BSW          | Black-surfaced wares                    | 33         | 979         | 3         | 0.25        |
| BUF          | Miscellaneous buff wares                | 4          | 27          |           |             |
| BUFM         | Miscellaneous buff ware mortaria        | 2          | 398         | 2         | 0.23        |
| EGSW         | East Gaulish samian ware                | 1          | 31          | 1         | 0.06        |
| ESH          | Early shell-tempered ware               | 20         | 55          |           |             |
| GRF          | Fine grey wares                         | 11         | 106         |           |             |
| GROG         | Fine grog-tempered ware (SOB GT)        | 2          | 30          |           |             |
| GRS          | Sandy grey wares                        | 114        | 1312        | 10        | 1.34        |
| HAR          | Hadham grey ware (HAD RE 1)             | 1          | 4           |           |             |
| MICW         | Miscellaneous Iron Age coarse wares     | 4          | 12          |           |             |
| NKG          | North Kent grey ware (UPC FR)           | 4          | 22          |           |             |
| RED          | Miscellaneous red wares                 | 7          | 21          |           |             |
| STOR         | Storage jar fabrics                     | 3          | 65          |           |             |
| UPOT         | Unidentified pottery                    | 10         | 5           |           |             |
| <b>Total</b> |   | <b>220</b> | <b>3140</b> | <b>17</b> | <b>2.02</b> |

Table 2: Quantification of late Iron Age and Roman fabrics (codes in brackets from Tomber and Dore 1998)

| Form         | Description                                  | BSW  | BUFM | EGSW | GRS  | Total EVE |
|--------------|--|------|------|------|------|-----------|
| B5           | Incipient bead-and-flanged dish              | 0.05 |      |      | 0.22 | 0.27      |
| C (Drag. 37) | Decorated hemispherical bowl                 |      |      | 0.1  |      | 0.06      |
| D3.2         | Mortarium with tall bead and drooping flange |      | 0.18 |      |      | 0.18      |
| D11          | Hammerhead mortarium                         |      | 0.05 |      |      | 0.05      |
| E            | Bowl-jar or wide-mouthed jar                 |      |      |      | 0.23 | 0.23      |
| G            | Jar  |      |      |      | 0.58 | 0.44      |
| G5.5         | Neckless, lid-seated jar                     |      |      |      | 0.07 | 0.58      |
| G10          | Wide-mouthed and cordoned necked jar         |      |      |      | 0.17 | 0.17      |



| Form             | Description                       | BSW         | BUFM        | EGSW       | GRS         | Total EVE   |
|------------------|-----------------------------------|-------------|-------------|------------|-------------|-------------|
| G11              | Neckless, everted rim jar         | 0.11        |             |            |             | 0.11        |
| G23/G24          | Oval-bodied necked jar            | 0.09        |             |            |             | 0.09        |
| G37.1            | Narrow-necked jar with hooked rim |             |             |            | 0.21        | 0.21        |
| <b>Total EVE</b> |                                   | <b>0.25</b> | <b>0.23</b> | <b>0.1</b> | <b>1.48</b> | <b>2.02</b> |

Table 3: Quantification by EVE of Roman pottery forms

### Assemblage composition

- B.2.2 Six context-groups, representing 13% of the assemblage by sherd count, were spot-dated to the late Iron Age or early Roman period. These were recovered from Trenches 73, 139, 148, 186 and 221. Contexts 7312 (ditch 7311), 13903 (ditch 13902) and 18603 (ditch 18602) contained shell-tempered pottery (ESH) dating from the early 1st to mid-2nd century AD. Pottery from another fill of ditch 13902 (context 13904) contained grog-tempered ware (GROG), which was accompanied by Roman-period black-burnished ware (BSW). It is possible that all the pottery from the feature was deposited after c AD 43. Grog-tempered pottery was also recovered from context 22104, a fill of ditch 22103.
- B.2.3 Some 36% of the assemblage by sherd count belonged to context-groups spot-dated to the middle Roman period (c AD 120-250). The pottery was recovered from six contexts recorded in Trenches 76, 140, 142, 143, 145, and 172. A relatively large group was recovered from context 14206 (pit 14205). Pottery diagnostic of the period from this group included a lid-seated jar (type G5.5) in sandy grey ware (GRS) and at least three incipient bead-and-flanges dishes (type B5) in fabrics GRS and BSW. Going (1987, 15) dates the dishes to the mid- to late 3rd century, but at Mucking (Jefferies and Lucy 2016, 177) the form is suggested to have been current from the late 2nd century. The examples here, however, may well have been made at Orsett itself, where the form is known to have been produced in the early/mid-3rd century (Cheer 1998, 98, 101, fig. 63, no. 21). Overall, a date for deposition within the late 2nd or first half of the 3rd century or later is likely for this group.
- B.2.4 Activity at this time is supported by the presence of a decorated bowl (Drag. 37) in East Gaulish samian ware (EGSW) from context 17205 (ditch 17204), a narrow-necked jar (G37) in fabric GRS from context 14512 (ditch 14510), and two buff ware mortaria (BUFM) from contexts 4604 (ditch 4503) and 14313 (ditch 14312). The mortaria is likely to have arrived from Heybridge, where production of such vessels in the later 2nd and early 3rd century is attested (Biddulph 2015, figs 317 and 318). Context 2404, a fill of ditch 2403, contained a sherd of Hadham grey ware (HAR), which dates from the late 2nd century onwards. It was with a small sherd of a flint-and-sand-tempered fabric (MICW) that is likely to be Iron Age and therefore residual.
- B.2.5 Three groups from Trenches 89, 140 and 143 contained pottery dating to the early to middle Roman period (c AD 43/50-250/70) and represented 15% of the assemblage by sherd count. Pottery included North Kent grey ware (NKG) from context 14005 (ditch 14002), a possible bag-shaped beaker in fabric GRF from context 14313 (ditch 14312), and a sherd from a South Spanish amphora (ABAET) from context 8903. The last was residual, being found with medieval pottery.
- B.2.6 A large proportion of the assemblage, 35% by sherd count, was from context-groups that could not be dated closely within the Roman period (c AD 43-410). This material

was collected from Trenches 7, 33, 71, 76, 78, 83, 93, 104, 112, 142, 144, 148, 150, 217 and 283. The pottery typically comprised undiagnostic sherds in coarse wares (BSW, GRF, GRS and RED). Some jar rims were noted, but none could be identified to precise type.

## Discussion

- B.2.7 The assemblage spans the late Iron Age and Roman periods, with the emphasis on the middle Roman period. It is possible that some of the pottery was deposited in the late Iron Age. However, it is notable that no relatively large groups containing pottery of late Iron Age tradition exclusively were recovered and that most grog-tempered ware was associated with Roman-period fabrics, suggesting that all deposition was of Roman or later date. No groups dated with certainty to the late Roman period were recovered.
- B.2.8 With much of the diagnostic pottery being consistent with a later 2nd or early/mid-3rd century date, it is a strong possibility that at least a proportion of the pottery was manufactured locally and fired in the kilns uncovered at Orsett Cock (Cheer 1998). That the B5-type dish was among the potters' repertoire has already been noted, and the G5.5 jar is also attested as a local product (Cheer 1998, fig. 63, no. 12). However, the Orsett kilns form part of a much wider zone of pottery production in the south Essex/Thameside region, and it is possible that pottery recovered from the current site was supplied by other workshops. For example, a cordoned, necked jar (type G10) in fabric GRS from context 14206 is similar to types made at Mucking (Jefferies and Lucy 2016, fig. 3.19, type FB01) and Dagenham (Biddulph 2010). Other sources of pottery include the North Kent marshes (NKG), Much Hadham in Hertfordshire (HAR), East Gaul (EGSW), Southern Spain (ABAET), and Heybridge (BUFM).
- B.2.9 The condition of the assemblage is mixed. It has a mean sherd weight (weight divided by sherd count) of 14.3g and a mean EVE or 'completeness' value (EVE divided by MV) of 0.12 EVE, which is indicative of the presence of relatively large sherds; a near-complete beaker, for instance, was found in context 14313. However, some context-groups consisted of little more than crumbs weighing less than 1g.
- B.2.10 While the assemblage was distributed across the evaluation area, pottery deposition was concentrated in the southern area of the evaluation in Land Parcel 3. Trenches 139, 140, 142, 143, and 150 contained relatively large amounts of pottery by sherd count, while the 'best-preserved' pottery – that is, pottery with high MSWs and above-average mean EVE values – was recorded in Trenches 142, 143, and 145. This suggests that deposition was concentrated in the southern area and that the pottery in this area had been deposited comparatively rapidly after initial breakage. Trenches in this area targeted features within a system of enclosures, which may have provided a focus of settlement. Elsewhere, the distribution of pottery was sparse and the pottery in poorer condition, suggesting that these areas were more peripheral to areas of use and that the pottery had undergone multiple episodes of redeposition.

## Recommendations for retention

- B.2.11 The pottery reported on here has the potential to inform future research through reanalysis, and thus it is recommended that all the pottery is retained. This follows the advice set out in the *Standard for Pottery Studies in Archaeology* (PCRG *et al.* 2016).

## B.3 Medieval Pottery

By John Cotter

### Introduction and methodology

- B.3.1 A total of 143 sherds of medieval and post-medieval pottery, weighing 1508g, was recovered from 12 contexts. Ordinary domestic wares were recovered. A range of pottery dating from perhaps the early/mid Anglo-Saxon period to the 19th century was identified. Nearly all of this, however, is medieval.
- B.3.2 All the pottery was scanned during the present assessment, and spot dates were provided for each context. Each context group was quantified by sherd count and weight and recorded on a spot-dating spreadsheet. The pottery is mostly in a very fragmentary and abraded condition, but some fresh sherds are also present.
- B.3.3 The context spot date is the date bracket during which the latest pottery types or fabrics are estimated to have been produced or were in general circulation. Comments on the range of fabrics were recorded, usually with mention of vessel form (jugs, bowls etc.) and any other attributes worthy of note (eg. decoration etc.). Fabric codes referred to are those of the Museum of London (MOLA 2014). Where appropriate, these are cross referenced to the fabric codes used by Essex County Council (Cotter 2000, 12–13). The range of pottery is described in some detail in Table 4 and is therefore only summarised below.

| Context | Spot-date   | Sherds | Weight | Comments  |
|---------|-------------|--------|--------|---|
| 104     | c 1550-1900 | 2      | 6      | 2x scraps post-med redware (PMR). 1 glazed; the other very abraded (or poss post-med tile/CBM?)   |
| 712     | c 1580-1750 | 2      | 8      | 1x bo (body sherd) black-glazed redware (PMBL) probably from a cylindrical mug. 1x bo PMR   |
| 3110    | 13-15C?     | 1      | 14     | Identification uncertain as sherd very abraded. Probably not Roman (seen by Edward Biddulph). Possibly a thick-walled narrow-necked late medieval drinking jug (or bottle?) in one of the medieval Surrey whitewares - possibly Kingston-type ware (KING, c 1250-1400) or Cheam (CHEA, c 1350-1500)? Wheel-thrown with surfaces mostly worn-off. Uniform sandy cream-buff fabric. No evidence of glaze surviving. Possibly weathered and plough-damaged, or water-worn by river/stream etc? |
| 4208    | 13-15C?     | 1      | 1      | Rounded scrap in same fabric as in (3110) but finer (KING/CHEA?). Traces of surfaces. Or unidentifiable?  |
| 7604    | c 400-750   | 7      | 104    | Probably 1 jar-like vessel. Anglo-Saxon organic-tempered ware (CHAF). Joining sherds from crudely handmade, slightly odd, slightly shouldered form with plain upright rim (3 rim sherds) and parts of rounded base. Fine silty fabric - abundant voids from burnt-out organic temper. Black fabric. Probably sooted   |

| Context | Spot-date    | Sherds | Weight | Comments  |
|---------|--------------|--------|--------|---|
| 8903    | c 1000-1225? | 10     | 312    | Probably all 1 vessel. Handmade cooking pot profile in shelly ware with everted squared rim and sagging base. Fairly large. Coarse shelly inclusions - mostly dissolved. Also, sparse-moderate grainy pellets/lumps of light brown-yellow sandy clay or weathered sandstone (resembling grog)? Possibly Essex EMSHX (c 1000-1225)? Or London early med shelly ware (EMSH, c 1050-1150)? Sooted/scorched   |
| 10402   | c 1270-1350  | 1      | 2      | Worn bo from jug. Fine orange sandy with some coarser quartz grains. Probably Mill Green ware (MG). Outside covered with white slip under a clear yellow glaze with some green flecks   |
| 10405   | c 1270-1350  | 97     | 936    | Minimum 10-12 vessels. Mainly one cooking pot profile with short horiz flanged rim in Mill Green coarseware (MG COAR, fine with just a scatter of quartz grits), one sherd of latter vess has an applied thumbed vertical strip; sooted ext. Bos from other MG COAR cook pots in coarser fabric, 1 with int clear glaze. 1x sagging base from wide bowl in MG COAR & a squared cook pot rim - both in an oxidised fabric containing sparse dissolved shell inclusions. 4x smallish sherds from Mill Green ware (MG) jugs with ext white slip under clear or green-flecked glaze, including a rod/oval-section jug handle. 1x MG COAR handle terminal from a pipkin or skillet. 1x flat base (diam 70mm) from drinking jug or bottle in Fabric 20 greyware (RCWX, fabric related to MG COAR?). Approx 10 other sherds F20, & c 20 sherds from cook pots with thumbed strips in Essex shelly-sandy ware (London SSWX; Essex Fabric 12C) the shell content is only sparse-moderate in this fabric. |
| 14116   | c 1175-1400  | 5      | 45     | Probably all Essex grey sandy ware (Essex Fabric 20/London RCWX)? All bos including 2 joining probably from jug shoulder (wheel-turned?). All sherds weathered with most of original surfaces missing. Mainly grey, or grey-brown with fine silty matrix and moderate-abundant coarse rounded/polished quartz grains and some rare angular flint. Sherds include part of a broken everted neck/rim  |
| 14208   | c 1480-1600  | 1      | 20     | Jar/pipkin with everted thickened/beaded rim. Essex-type early post-medieval redware (40EA; similar London PMRE). Glaze specks on neck. Very fresh condition  |
| 19203   | c 1820-1900  | 1      | 6      | Transfer-printed ware (TPW). Bo from ?jug in very hard ironstone-type fabric with blurred light blue floral printed decoration  |
| 21408   | c 1805-1900  | 1      | 6      | Bowl base sherd. Refined whiteware (REFW)   |

| Context      | Spot-date    | Sherds     | Weight      | Comments  |
|--------------|--------------|------------|-------------|---|
| 28409        | c 1100-1350? | 1          | 14          | Fresh body sherd (bo) from large globular vessel - probably a cooking pot (traces of sooting ext). Thin-walled, possibly handmade or slow-turned? Hard-fired shell-tempered fabric with moderate medium-coarse shell inclusions (mostly voided) in a smooth almost sand-free matrix. Grey surfaces with a sandwich core comprising broad orange-brown margins and thin dark grey inner core. Sparse medium-coarse quartz inclusions and sparse coarse rounded orange-brown iron-rich clay pellets or iron oxide. Some fine mica on surfaces. Not very diagnostic but more likely medieval than Roman - despite being quite hard-fired. Possibly 13C - like shelly ware in the Mill Green/Chelmsford area? Essex Fabric 12C? (Seen by Ed Biddulph) |
| 28411        | c 1100-1300? | 2          | 8           | Small worn bos in smooth sand-free brown fabric with abundant coarse voided shell inclusions. 2 vess. Smooth silty matrix. Low-fired. Essex Fabric 12A/B (London code SEMS - South Essex shell-tempered ware)?  |
| 28412        | c 1100-1300? | 4          | 8           | Small worn shelly ware bos as in 28411. All heavily sooted ext - cooking pots?  |
| 28413        | 13-14C?      | 3          | 12          | 2x small worn shelly ware bos as in 28411 but with moderate shell (Essex Fabric 12A/B)? Sooted ext. 1x oxidised fine orange-brown flattish bo, surfaces worn-off. Fine silty matrix with rare-sparse shell voids. Similar to some fine Mill green ware (MG) variant fabrics containing rare-sparse shell - if so might date c 1250-1350? Identification uncertain though (Essex Fabric 12A?)  |
| 28504        | c 1100-1300? | 4          | 6           | 3x small worn shelly ware bos as in 28411 (Essex Fabric 12A/B? 1 vess?). 1x bo in related but sandier grey-brown fabric with abundant fine-medium rounded quartz, sparse-medium shell voids and sparse inclusions of white and pale grey angular flint - probably a medieval shelly-sandy ware (Essex Fabric 12C)   |
| <b>TOTAL</b> |              | <b>143</b> | <b>1508</b> |   |

Table 4: Description of post-Roman pottery by context

## Discussion

- B.3.4 The pottery comprises ordinary domestic wares typical of this part of south Essex and ranges in date from the early/mid Anglo-Saxon period to the 19th century. Medieval wares of the later 13th to 14th century, however, predominate.
- B.3.5 Context 7604 produced fresh sherds, including rims, from a single jar in early to middle Anglo-Saxon organic-tempered ware (Fabric code CHAF). This ware has a broad date range in south-east England (mainly c AD 400–750) and shows little or

no typological change during the period. Some occupation during this date is therefore attested here.

- B.3.6 A cooking pot profile in Essex-type early medieval shelly ware (EMSHX) came from another context (8903). This probably dates to c 1000–1225.
- B.3.7 Most of the pottery here (97 sherds) came from a single context (10405). This can be dated to c 1270–1350 with a fair degree of confidence because of the presence of glazed and white-slipped jug sherds in Mill Green ware (MG). Mill Green ware was produced at Ingatestone in central Essex and had a wide distribution in Essex and the Thames estuary area. Mill Green coarse ware (MG COAR) was another product of this industry. The same context includes one or two well-preserved cooking pots in this fabric, a bowl base and a probable pipkin (saucepan) handle. Sherds of Essex medieval grey sandy ware (Fabric 20/RCWX) are also present, including the base of a small drinking jug or bottle. Sherds from shelly-sandy ware cooking pots (London SSWX; Essex Fabric12C) are present here too. Altogether the pottery from this context – and one or two others close by – attests to significant occupation here in the late medieval period.
- B.3.8 A small number of post-medieval redware sherds (PMRE, PMR, PMBL) and a two 19th-century sherds (TPW, REFW) were also recovered.

#### **Recommendations regarding the conservation, discard and retention of material**

- B.3.9 The pottery here has potential to inform research through reanalysis. The decorated Anglo-Saxon sherd is quite unusual and should be researched further. It should all therefore be retained and properly catalogued and reported at some future date, along with material from any subsequent formal excavations in this area.

## B.4 Flint

By Lawrence Billington

### Introduction

- B.4.1 A total of 77 struck flints were recovered during the evaluation, alongside a relatively large assemblage of 4351g (over 1000 fragments) of unworked burnt flint, the latter derived mostly from a series of cremation burials investigated in Trench 136.
- B.4.2 The assemblage was catalogued directly onto an Excel spreadsheet and the artefacts were classified according to a system of broad artefact/debitage types based on standard definitions for post-glacial lithic assemblages from southern Britain (eg Bamford 1985, 72-77; Healy 1988, 48-9; Butler 2005). Additional information on selected technological and non-metric attributes of the material (including platform type/preparation, hammer mode and dorsal cortex coverage) was also recorded using standard classifications and terminology based largely on those set out by Inizan and colleagues (1999).
- B.4.3 A summary quantification catalogue of the assemblage is provided in Table 5 and a catalogue by context in Table 6, with full details of the recording retained in the project archive.

| Type                          | Count         |
|-------------------------------|---------------|
| Chip                          | 3             |
| Irregular waste               | 4             |
| Flake                         | 38            |
| Blade/let                     | 10            |
| Blade-like flake              | 9             |
| Crested blade                 | 1             |
| End scraper                   | 1             |
| Side scraper                  | 1             |
| Piercer                       | 1             |
| Misc. retouched               | 1             |
| Serrated blade                | 1             |
| Irreg. core                   | 1             |
| Multi. platform core          | 1             |
| Tested nodule                 | 3             |
| Core on flake                 | 1             |
| Hammerstone                   | 1             |
| <b>Total worked</b>           | <b>77</b>     |
| <b>Unworked burnt</b>         | <b>519</b>    |
| <b>Unworked burnt wt. (g)</b> | <b>4350.5</b> |

Table 5. Summary quantification of the flint assemblage

### Raw materials and condition

- B.4.4 The struck flint is varied in terms of colour and texture but was generally fine grained and of good knapping quality, with surviving cortical surface suggesting most of the flint derived from small to medium sized cobbles/nodules with abraded and weathered surfaces suggesting a source from secondary deposits of gravel, probably including those of the Boyn Hill Gravel member, which outcrops across the western part of the evaluated area. Two large tested/minimally worked cobbles of this kind of gravel flint were recovered from subsoil deposits in Trench 235 and 245, and probably

represented the on-site procurement and testing of material. Possible non-local raw material is represented by two flakes of Bullhead flint (from natural deposit 243030, Trench 242 and fill of ditch 20004, Trench 200), and a very small number pieces with relatively fresh unweathered cortical surfaces where also recorded, and these may represent material derived from deposits more closely associated with the parent chalk.

- B.4.5 Gravel derived flint appears to have been the main source of material in the assemblage of predominantly early Neolithic flintwork recovered during excavation of the Orsett causewayed enclosure, immediately to the south of the site (Bonsall 1978), and in the very large multi-period assemblage accumulated during the excavations on the Boyn Hill terrace gravels at Mucking, little more than 2km to the south-east, although here, as in the present assemblage, small quantities of Bullhead flint and possible chalk flint were also recorded west (Healey 2016, 53).
- B.4.6 The condition of the worked flint varied but a high proportion displayed at least some slight edge damage/rounding, whilst other pieces – especially those from ploughsoil contexts – had more severe edge damage. Cortication ('patination') was entirely absent.

#### **Worked flint: quantification and distribution**

- B.4.7 The worked flint was very thinly distributed, with the 77 pieces deriving from 52 individual contexts recorded from 35 of the excavated trenches. Over a third of this material was recovered from the fills of cut features (29 pieces). Given the very low densities of flintwork recovered from cut features and the condition of the flintwork from these contexts, it seems likely that the vast majority represents residual material inadvertently caught up in the fills of later features. A further 19 pieces came from ploughsoil or subsoil deposits, with 17 pieces coming from natural deposits ('natural' and alluvial layers).
- B.4.8 Although the distribution of the flint has not been analysed in detail, the majority of the assemblage derives from two main areas of trenching; the first from the large block of trenches on the gravels in the south-western part of the area (Trenches 37-150) and from a block of trenches in the north-western part of the area on the head deposits north-west of Orsett (Trenches 228-251). A total of 41 worked flints (53% of the assemblage) came from Trenches 37-150, deriving from cut features and ploughsoil deposits with something of a concentration in the area of Trenches 87, 88 and 96 (which collectively produced ten worked flints). The area of Trenches 228-251 produced 31 flints (40% of the assemblage), and here most of the flintwork was recovered in low densities from ploughsoil deposits and underlying subsoils, alluvial layers and the natural.

#### **Worked flint: technology, typology and dating**

- B.4.9 This relatively small assemblage is dominated by unretouched removals, alongside three cores, three 'tested nodules'/minimally worked cores, five retouched tools and a fragment of hammerstone.
- B.4.10 The assemblage includes a substantial blade-based component, with blades and blade-like flakes making up almost a third of unretouched removals. There are no clear differences in the prevalence or distribution of this blade-based material across the area, with both of the main groups/assemblages of flintwork from Trenches 37-150 and 228-251 having relatively high proportions of blades and bladelets. There is



significant variation in the character of these blade-based products, with a small number of prismatic bladelets/blades probably representing Mesolithic material, alongside a larger number of somewhat less regular/standardised pieces more likely to be of earlier Neolithic date. Most distinctive among this material is the distal portion of a crested blade (on bullhead flint) from natural deposit 24202, Trench 242 – most likely to be of Mesolithic date. This same deposit also yielded the proximal portion of a large blade or blade-like flake (33m wide) with a finely faceted striking platform and with clear evidence for intentional breakage in the form of an impact mark and wedge shaped fracture lines at its distal break. This piece may derive from a later Neolithic prepared platform core (cf. Levallois-like technologies, Ballin 2011) or, possibly, could even be of late glacial (Upper Palaeolithic) date.

- B.4.11 Alongside this distinctive blade-base material, the remainder of the assemblage is dominated by simple flake-based removals, generally hard hammer struck from unprepared, plain or cortical striking platforms. Little of this material is in any way diagnostic, but much is likely to date to the late Neolithic or early Bronze Age. There is no clear indication of especially crudely/expediently worked material suggestive of a later Bronze Age or Iron Age date.
- B.4.12 Apart from several minimally worked/tested nodules/cobbles, the few cores recovered consist of a small irregular flake core (alluvial layer 23506, Trench 235), a multiple platform blade/narrow flake core (pit 4203, Trench 42) and a core on a flake, bearing narrow, burin-like bladelet removals from one edge (ploughsoil 23500, Trench 235). The last two are likely to be of Mesolithic or earlier Neolithic date.
- B.4.13 Of the retouched tools in the assemblage, the most notable is a serrated blade from the ploughsoil of Trench 88, made on a fine secondary blade blank. This piece bears very fine serrations along one lateral edge (accompanied by some faint use-gloss or polish), as well as some with some limited dorsal retouch at its distal end. Serrated pieces such as this are a long-lived form, but they are especially common in early Neolithic assemblages, and locally this piece can be compared with early Neolithic examples recovered from the lower fills of the ditch of the Orsett causewayed enclosure (Bonsall, 1978, fig. 24, nos 3 and 4). The other retouched tools are not chronologically diagnostic and consist of a simple convex end scraper from the ploughsoil of Trench 96, an irregular side scraper (with ventral retouch) from natural layer 23102 (Trench 231), a short piercer from alluvial layer 22802 (Trench 228) and the distal end of a robust narrow flake or blade with some direct distal retouch from natural layer 23502 (Trench 235).
- B.4.14 Alongside this distinctive blade-base material, the remainder of the assemblage is dominated by simple flake-based removals, generally hard hammer struck from unprepared, plain or cortical striking platforms. Little of this material is in any way diagnostic, but much is likely to date to the late Neolithic or early Bronze Age. There is no clear indication of especially crudely or expediently worked material suggestive of a later Bronze Age or Iron Age date.

### **Unworked burnt flint**

- B.4.15 Apart from small quantities of material from various features investigated across the evaluation area (see Table 5), the vast majority of the unworked burnt flint was recovered from a series of cremation burials investigated in Trench 136. This material was recovered from the wet-sieved residues of bulk samples taken from the three

cremation burials (13609, 13610 and 13613), and comprises a total of 3687g (some 1040 pieces) of heavily burnt, fractured/shattered fragments of flint.

- B.4.16 Full quantification of the burnt flint recovered from each of the samples from these burials are provided in Table 5. In summary, wet sieving of four samples from cremation 13610 produced 2025g of burnt flint, four samples from cremation 13609 produced 1638g of burnt flint and three samples from cremation 13613 produced a much smaller assemblage of 24g of burnt flint. The material from all these features was closely comparable, consisting of highly fragmented angular pieces which have experienced severe thermal fracturing. This is reflected in a low mean clast weight of around 3.5g, with the mass of the assemblage consisting of small pieces and spalls alongside a small number of fractured cobbles/pebbles up to c 70mm in maximum dimension.
- B.4.17 Although small quantities of burnt flint, presumably inadvertently caught up in the pyre, are a frequent inclusion in prehistoric and Roman cremation deposits, assemblages of this size are unusual. In this context the reason for its occurrence here is not clear. It is possible that the pyre site was located on an exposed gravel surface and that heat-affected stones were gathered up from the pyre during recovery of the cremated bone, or perhaps even that part of the pyre structure included gravel in its construction, but either way it seems clear that little attempt was made to exclude the burnt flint from the material selected for burial.

### **Discussion**

- B.4.18 Given the scale of the evaluation, the worked flint assemblage is relatively small and there are no large or coherent individual assemblages. That said, the assemblage provides some indication of prehistoric activity at that site, and it is notable that this includes evidence for early Neolithic activity which may be broadly contemporary with the construction and use of the nearby Orsett causewayed enclosure. Perhaps the most significant aspect of the assemblage is the recovery of small quantities of flintwork from natural deposits and alluvial layer from trenches in the north-western part of the evaluated area (Trenches 228, 230, 231, 235, 242, 243 and 244). Although occurring in very low densities this material does hint at the possibility for the preservation of relatively undisturbed lithic scatters in this area, although in this case the trenching does not appear to have located any significant scatters.
- B.4.19 In terms of the general distribution and density of flintwork, while it is difficult to make comparisons between assemblages such as this, derived from trial trenching, with those from more intensively excavated sites, the intensity of prehistoric activity across much of the evaluated area seems to be significantly lower than seen on the main areas of the gravel terraces slightly further south, as exemplified by the excavations at Mucking, where episodic Neolithic and early Bronze Age occupation was indicated by the very extensive lithic assemblage and occasional pits and pit clusters associated with contemporary pottery (Evans *et al.* 2016).
- B.4.20 The large assemblages of burnt flint from the cremation burials on Trench 136 are unusual, and if further work is carried out at the site, this material should be reconsidered in the light of any dating evidence for the burials.

| Context | Cut/Parent | Context type    | Sample | Chip | Irregular waste | Flake | Blade/let | Blade-like flake | Crested blade | End scraper | Side scraper | Piercer | Misc. retouched | Serrated blade | Irreg. core | Multi. platform core | Tested nodule | Core on flake | Hammerstone | Total worked | Unworked burnt | Unworked burnt wt. (g) |
|---------|------------|-----------------|--------|------|-----------------|-------|-----------|------------------|---------------|-------------|--------------|---------|-----------------|----------------|-------------|----------------------|---------------|---------------|-------------|--------------|----------------|------------------------|
| 4005    | 0          | Subsoil         |        |      |                 | 2     |           |                  |               |             |              |         |                 |                |             |                      |               |               |             | 2            |                |                        |
| 4204    | 4203       | Pit             |        |      |                 |       |           |                  |               |             |              |         |                 |                |             | 1                    |               |               |             | 1            |                |                        |
| 4406    | 4405       | Ditch           |        |      |                 | 1     |           |                  |               |             |              |         |                 |                |             |                      |               |               |             | 1            |                |                        |
| 4606    | 4605       | Ditch           | 26     |      |                 |       |           |                  |               |             |              |         |                 |                |             |                      |               |               |             |              | 2              | 12                     |
| 6104    | 6103       | Ring Ditch      |        |      |                 | 1     |           |                  |               |             |              |         |                 |                |             |                      |               |               |             | 1            |                |                        |
| 6108    | 6107       | Ditch           |        |      |                 |       |           | 1                |               |             |              |         |                 |                |             |                      |               |               |             | 1            |                |                        |
| 6205    | 6203       | Ditch           |        |      |                 |       |           |                  |               |             |              |         |                 |                |             |                      |               |               |             |              | 1              | 21                     |
| 6404    | 6403       | Ditch           |        |      |                 | 1     |           |                  |               |             |              |         |                 |                |             |                      |               |               |             | 1            | 12             | 143                    |
| 6409    | 6408       | Ditch           |        |      |                 | 2     |           |                  |               |             |              |         |                 |                |             |                      |               |               |             | 2            | 7              | 164                    |
| 6900    | 6900       | Ploughsoil      |        |      |                 | 1     |           |                  |               |             |              |         |                 |                |             |                      |               |               |             | 1            |                |                        |
| 6904    | 6903       | Pit             |        |      |                 |       |           | 1                |               |             |              |         |                 |                |             |                      |               |               |             | 1            |                |                        |
| 7102    | 7103       | Pit             |        |      |                 | 1     |           |                  |               |             |              |         |                 |                |             |                      |               |               |             | 1            |                |                        |
| 7206    | 7205       | Ditch           |        |      |                 | 1     |           |                  |               |             |              |         |                 |                |             |                      |               |               |             | 1            |                |                        |
| 7506    | 7505       | Pit             |        |      |                 |       |           | 1                |               |             |              |         |                 |                |             |                      |               |               |             | 1            |                |                        |
| 7604    | 7603       | Pit             |        |      |                 | 1     |           |                  |               |             |              |         |                 |                |             |                      |               |               |             | 1            |                |                        |
| 7605    | 7603       | Pit             |        |      | 1               | 1     |           |                  |               |             |              |         |                 |                |             |                      |               |               |             | 2            |                |                        |
| 8703    | 0          | Natural feature |        |      |                 | 1     | 1         |                  |               |             |              |         |                 |                |             |                      |               |               |             | 2            |                |                        |
| 8800    | 8800       | Ploughsoil      |        |      |                 |       |           |                  |               |             |              |         |                 | 1              |             |                      |               |               |             | 1            |                |                        |
| 8803    | 8802       | Pit             |        | 1    |                 | 2     |           |                  |               |             |              |         |                 |                |             |                      |               |               |             | 3            |                |                        |
| 8804    | 8802       | Pit             |        | 1    |                 |       |           | 1                |               |             |              |         |                 |                |             |                      |               |               |             | 2            |                |                        |
| 9303    | 9302       | Pit             |        | 1    |                 |       |           |                  |               |             |              |         |                 |                |             |                      |               |               |             | 1            |                |                        |
| 9600    | 9600       | Ploughsoil      |        |      |                 |       |           |                  |               | 1           |              |         |                 |                |             |                      |               |               |             | 1            |                |                        |
| 9608    | 9607       | Ditch           |        |      |                 |       | 1         |                  |               |             |              |         |                 |                |             |                      |               |               |             | 1            |                |                        |
| 9803    | 9802       | Ditch           |        |      |                 | 1     |           |                  |               |             |              |         |                 |                |             |                      |               |               |             | 1            |                |                        |
| 9805    | 9804       | Pit             |        |      |                 | 2     |           |                  |               |             |              |         |                 |                |             |                      |               |               |             | 2            |                |                        |

| Context | Cut/Parent | Context type  | Sample | Chip | Irregular waste | Flake | Blade/let | Blade-like flake | Crested blade | End scraper | Side scraper | Piercer | Misc. retouched | Serrated blade | Irreg. core | Multi. platform core | Tested nodule | Core on flake | Hammerstone | Total worked | Unworked burnt | Unworked burnt wt. (g) |
|---------|------------|---------------|--------|------|-----------------|-------|-----------|------------------|---------------|-------------|--------------|---------|-----------------|----------------|-------------|----------------------|---------------|---------------|-------------|--------------|----------------|------------------------|
| 10004   | 10003      | Ditch         |        |      |                 |       |           |                  |               |             |              |         |                 |                |             |                      |               |               | 1           | 1            | 1              | 18                     |
| 10400   | 10400      | Ploughsoil    |        |      |                 |       |           | 1                |               |             |              |         |                 |                |             |                      |               |               |             | 1            |                |                        |
| 10405   | 10404      | Pit           |        |      |                 | 1     |           | 1                |               |             |              |         |                 |                |             |                      |               |               |             | 2            |                |                        |
| 10605   | 10604      | Ditch         |        |      |                 | 1     |           |                  |               |             |              |         |                 |                |             |                      |               |               |             | 1            |                |                        |
| 13611   | 13610      | Cremation Cut | 4      |      |                 |       |           |                  |               |             |              |         |                 |                |             |                      |               |               |             |              | 103            | 963                    |
| 13611   | 13610      | Cremation Cut | 5      |      |                 |       |           |                  |               |             |              |         |                 |                |             |                      |               |               |             |              | 181            | 1030                   |
| 13611   | 13610      | Cremation Cut | 6      |      |                 |       |           |                  |               |             |              |         |                 |                |             |                      |               |               |             |              | 16             | 23                     |
| 13611   | 13610      | Cremation Cut | 12     |      |                 |       |           |                  |               |             |              |         |                 |                |             |                      |               |               |             |              | 1              | 9                      |
| 13612   | 13609      | Cremation Cut | 8      |      |                 | 1     |           |                  |               |             |              |         |                 |                |             |                      |               |               |             | 1            | 33             | 570                    |
| 13612   | 13609      | Cremation Cut | 11     |      |                 |       |           |                  |               |             |              |         |                 |                |             |                      |               |               |             |              | 0              | 17                     |
| 13612   | 13609      | Cremation Cut | 12     |      |                 |       |           |                  |               |             |              |         |                 |                |             |                      |               |               |             |              | 116            | 1007                   |
| 13612   | 13609      | Cremation Cut | 15     |      |                 |       |           |                  |               |             |              |         |                 |                |             |                      |               |               |             |              | 6              | 44.1                   |
| 13614   | 13613      | Cremation Cut | 10     |      |                 |       |           |                  |               |             |              |         |                 |                |             |                      |               |               |             |              | 1              | 9                      |
| 13614   | 13613      | Cremation Cut | 13     |      |                 |       |           |                  |               |             |              |         |                 |                |             |                      |               |               |             |              | 3              | 9                      |
| 13614   | 13613      | Cremation Cut | 16     |      |                 |       |           |                  |               |             |              |         |                 |                |             |                      |               |               |             |              | 2              | 6                      |
| 14005   | 14002      | Ditch         |        |      | 1               | 3     |           |                  |               |             |              |         |                 |                |             |                      |               |               |             | 4            |                |                        |
| 14206   | 14205      | Pit           | 14     |      |                 |       |           |                  |               |             |              |         |                 |                |             |                      |               |               |             |              | 18             | 32.4                   |

| Context | Cut/Parent | Context type   | Sample | Chip | Irregular waste | Flake | Blade/let | Blade-like flake | Crested blade | End scraper | Side scraper | Piercer | Misc. retouched | Serrated blade | Irreg. core | Multi. platform core | Tested nodule | Core on flake | Hammerstone | Total worked | Unworked burnt | Unworked burnt wt. (g) |      |
|---------|------------|----------------|--------|------|-----------------|-------|-----------|------------------|---------------|-------------|--------------|---------|-----------------|----------------|-------------|----------------------|---------------|---------------|-------------|--------------|----------------|------------------------|------|
| 14805   | 14804      | Pit            | 2      |      |                 |       |           |                  |               |             |              |         |                 |                |             |                      |               |               |             |              | 4              | 22                     |      |
| 17604   | 17603      | Ditch          |        |      |                 |       |           |                  |               |             |              |         |                 |                |             |                      |               |               |             |              | 1              | 6                      |      |
| 18200   | 18200      | Ploughsoil     |        |      |                 | 1     |           |                  |               |             |              |         |                 |                |             |                      |               |               |             |              | 1              |                        |      |
| 20004   | 20003      | Ditch          |        |      |                 | 1     |           |                  |               |             |              |         |                 |                |             |                      |               |               |             |              | 1              |                        |      |
| 20100   | 20100      | Ploughsoil     |        |      |                 |       |           | 1                |               |             |              |         |                 |                |             |                      |               |               |             |              | 1              |                        |      |
| 21704   | 21703      | Quarry         |        |      |                 | 1     |           |                  |               |             |              |         |                 |                |             |                      |               |               |             |              | 1              |                        |      |
| 22110   | 22109      | Ditch          |        |      |                 | 1     |           |                  |               |             |              |         |                 |                |             |                      |               |               |             |              | 1              |                        |      |
| 22801   | 22801      | Subsoil        |        |      |                 | 1     |           |                  |               |             |              |         |                 |                |             |                      |               |               |             |              | 1              |                        |      |
| 22802   | 22802      | Alluvial Layer |        |      |                 |       | 1         |                  |               |             |              | 1       |                 |                |             |                      |               |               |             |              | 2              |                        |      |
| 23002   | 23002      | Alluvial Layer |        |      |                 |       |           |                  |               |             |              |         |                 |                |             |                      |               |               |             |              | 5              | 140                    |      |
| 23102   | 23102      | Natural        |        |      |                 |       |           |                  |               |             | 1            |         |                 |                |             |                      |               |               |             |              | 1              |                        |      |
| 23500   | 23500      | Ploughsoil     |        |      |                 |       |           |                  |               |             |              |         |                 |                |             |                      |               | 1             |             |              | 1              |                        |      |
| 23501   | 23501      | Subsoil        |        |      |                 |       |           |                  |               |             |              |         |                 |                |             |                      | 1             |               |             |              | 1              | 8.8                    |      |
| 23502   | 23502      | Natural        |        |      | 1               |       |           |                  |               |             |              |         | 1               |                |             |                      |               |               |             |              | 2              |                        |      |
| 23506   | 23506      | Alluvial Layer |        |      | 1               | 1     |           |                  |               |             |              |         |                 |                | 1           |                      |               |               |             |              | 3              |                        |      |
| 23601   | 23601      | Subsoil        |        |      |                 | 1     |           |                  |               |             |              |         |                 |                |             |                      |               |               |             |              | 1              |                        |      |
| 23701   | 23701      | Subsoil        |        |      |                 |       | 1         |                  |               |             |              |         |                 |                |             |                      |               |               |             |              | 1              | 4                      | 41.5 |
| 24000   | 24000      | Ploughsoil     |        |      |                 | 1     |           |                  |               |             |              |         |                 |                |             |                      |               |               |             |              | 1              |                        |      |
| 24202   | 24202      | Natural        |        |      |                 |       | 1         |                  | 1             |             |              |         |                 |                |             |                      | 1             |               |             |              | 3              |                        |      |
| 24300   | 24300      | Ploughsoil     |        |      |                 | 1     | 2         |                  |               |             |              |         |                 |                |             |                      |               |               |             |              | 3              |                        |      |
| 24302   | 24302      | Natural        |        |      |                 | 1     | 2         |                  |               |             |              |         |                 |                |             |                      |               |               |             |              | 3              |                        |      |
| 24304   | 24303      | Ditch          |        |      |                 |       |           |                  |               |             |              |         |                 |                |             |                      |               |               |             |              | 1              | 55.3                   |      |
| 24306   | 24305      | Ditch          |        |      |                 |       | 1         | 1                |               |             |              |         |                 |                |             |                      |               |               |             |              | 2              |                        |      |
| 24402   | 24402      | Natural        |        |      |                 | 3     |           |                  |               |             |              |         |                 |                |             |                      |               |               |             |              | 3              |                        |      |

| Context | Cut/Parent | Context type | Sample | Chip | Irregular waste | Flake | Blade/let | Blade-like flake | Crested blade | End scraper | Side scraper | Piercer | Misc. retouched | Serrated blade | Irreg. core | Multi. platform core | Tested nodule | Core on flake | Hammerstone | Total worked | Unworked burnt | Unworked burnt wt. (g) |  |
|---------|------------|--------------|--------|------|-----------------|-------|-----------|------------------|---------------|-------------|--------------|---------|-----------------|----------------|-------------|----------------------|---------------|---------------|-------------|--------------|----------------|------------------------|--|
| 24403   | 0          | Ditch        |        |      |                 |       |           | 1                |               |             |              |         |                 |                |             |                      |               |               |             |              | 1              |                        |  |
| 24500   | 24500      | Ploughsoil   |        |      |                 | 1     |           |                  |               |             |              |         |                 |                |             |                      |               |               |             |              | 1              |                        |  |
| 24501   | 24501      | Subsoil      |        |      |                 |       |           |                  |               |             |              |         |                 |                |             |                      | 1             |               |             |              | 1              |                        |  |

Table 6: Flint assemblage

## **B.5 Fired Clay**

By Alex Davies

- B.5.1 A single piece of fired clay was found in context 18403. This is from a late Bronze Age perforated slab or plate. The piece weighs 40g and measures 48 x 42 x 15mm. It is from the corner of the object, surviving up to the edge of the nearest perforation. The rim on one of the edges is a dished U-shape. The fabric includes fine-moderate flint, very similar to the pottery sherd found in the same context. These are common late Bronze Age finds in the lower Thames Valley/estuary (Harrison 2000).

### **Retention**

- B.5.2 The piece has future research value and should be retained.

## B.6 Ceramic Building Material

By Kirsty Smith and Cynthia Poole

### Introduction and methodology

- B.6.1 A modest assemblage of ceramic building material (CBM) amounting to 84 fragments weighing 5.7kg was recovered from Trenches 1, 5, 7, 25, 47, 76, 89, 105, 122, 142, 172, 186, 198, 214, 246, 283, and 303. The majority of the assemblage was post-medieval in date although ten fragments of Roman tile and one fragment of medieval tile was also recovered. The fragments of Roman tile were heavily abraded and poorly preserved (except for two fragments of tegula), whereas the post-medieval material had moderate abrasion and several larger fragments of brick were well preserved. The assemblage had a mean fragment weight of 155g.
- B.6.2 The assemblage has been fully recorded on an Excel spreadsheet in accordance with guidelines set out by the Archaeological Ceramic Building Materials Group (ACBMG 2007) and is summarised in the table below (Table 7). The record includes quantification, details of fabric type, form, and evidence of use/reuse (burning etc). Fabrics were characterised on the basis of macroscopic features supplemented by the use of x40 hand lens for finer constituents.

### Roman tile

- B.6.3 Roman tile comprised two fragments of tegula roofing tile, four fragments of flat tile and four fragments of possible tegula weighing in total 629g. Dating cannot be more precise than Roman for this small assemblage. These fragments were made in a variety of red/pink-orange fine sandy fabric with mica inclusions. The two joining fragments of tegula from context 112 were worn but were relatively well preserved and had a standard rectangular upper cutaway 41mm long. These fragments were recovered from ditch 111 in Trench 1. The flange was 13.5mm wide and had possibly been removed deliberately for reuse as a flat tile. The other four fragments of Roman tile were 17-23mm thick and were from pit 7606, ditch 8902 and pit 14205. These fragments had burning on one or more surfaces, perhaps indicating reuse of the material in an oven or hearth. The four fragments of possible tegula from ditch 30303 were worn and moderately to heavily abraded. Two of the fragments appeared to have part of a rounded flange (profile E) surviving and were 30mm and 33mm wide. The other two fragments from this context were heavily abraded but were made of the same fabric.

### Medieval CBM

- B.6.4 One late medieval (or early post-medieval) peg tile of 14th-16th century date was recovered from Trench 186 (context 18607). This weighed 161g and measured 15mm thick. It was made in an orange-pink sandy fabric, containing iron oxide grit inclusions. The tile was roughly finished and had an uneven peg hole at one end that measured 12.8mm in diameter. A fragment of flat roof tile in the same fabric was recovered from Trench 246 (context 24604). This was 13.5mm thick and weighed 70g.

### Post-medieval CBM

#### *Brick*

- B.6.5 The post-medieval brick comprised 52 fragments (3781g) which were found in ditches within Trenches 5, 7, 25, 122, 198, 246 and 303. Brick was also found in one unexcavated pit in Trench 47. The majority of these bricks were made from a moderately sandy orange-red fabric apart from the bricks from 4703, 19804 and



30304 which were a dark purple/red brown colour. The inclusions within these brick fragments varied. The bricks from Trenches 7 and 47 had black cinder, coarse flint and quartzite inclusions up to 5mm size. The heavily abraded fragments from Trench 246 also had black cinder inclusions. The bricks from Trenches 5, 25 and 122 had cream clay pellets and iron grit inclusions. Three bricks, from context 504, 713 and 2508 were more complete than the others, the first two being 55mm thick and the brick from 2508 being 66mm thick. The bricks from contexts 504, 19804 and 30304 were dated to the 17th-18th century and the brick from 713 to the 16th-17th century. The brick from 2508 was more regular with sharp arrises, probably produced in a metal lined stock mould, and dates to the 18th-19th century. The rest of the bricks comprised amorphous fragments and could not be dated more precisely than post-medieval.

### *Flooring*

- B.6.6 Two fragments of floor tile/paviours (647g) were recovered from Trenches 5 and 105. The tile from 504 was made in an orange sandy fabric with cream striations and contained iron oxide grit and mica inclusions. The unglazed brick paviour or floor tile was 39mm thick and had creasing along one edge and burning on the tip of one edge. This paviour was dated to the 17th-18th century. The paviour from context 10505 was made from an orange-pink fabric with mica and black cinder inclusions. This brick paviour had a regular finish, creased edge surface and angular arrises, possibly indicating that a metal mould was used. This paviour dated to the 18th-19th century.

### *Roof tile*

- B.6.7 Ten fragments of post-medieval flat rectangular roof tile (489g), probably of peg tile form, were recorded from Trenches 105, 172, 186, 214, 283 and 284. These were all made from an orange-pink or light orange sandy fabric, and the fabrics from contexts 10505 and 17209 had mica inclusions. The earliest piece was a peg tile from 18607 dated to 14th-16th century. It had a rough finish, measured 15mm thick and was pierced by an irregular peg hole measuring 13mm in diameter. The roof tile from 17209 was 13mm thick and dated to the 16th-18th century. The later roof tile was all thinner measuring 10-12mm thick. The peg tile from context 28306 was dated to the 17th-19th century and the peg hole was 12mm in diameter. The roof tile from context 28411 was broadly the same date. The fragment of roof tile from context 21408 was made of a finer fabric and was later in date (later 18th-19th century). The fragment of tile from 10505 could not be dated more precisely than the post-medieval period.

### *Miscellaneous*

- B.6.8 One fragment of possible CBM from context 7606 (4g) was made of a mauve, coarse sandy fabric. Two fragments (7g) from context 21406 were made from an orange fabric with occasional ferruginous inclusions. These fragments were small, and the forms could not be determined.
- B.6.9 One fragment of a curved stoneware pipe was recorded in context 30304 from ditch 30303. This was made from cream/white stoneware with black grits up to 3mm long. The inside and the outside surfaces had brown glaze and the pipe was 15mm thick. This pipe is 19th century in date.

| Context | Spot date     | Count | Weight (g) | Form                        | Comments  |
|---------|---------------|-------|------------|-----------------------------|---|
| 112     | Roman         | 2     | 152        | Tegula                      | Tegula joining pieces (fresh break). Standard upper cut away 41mm long. Flange (13.5mm wide) removed possibly for reuse. Thickness 25mm |
| 504     | c 17–18       | 1     | 333        | Brick paviour or floor tile | Unglazed floor tile with creasing along the edge and burning on tip of one edge. Thickness 39mm   |
| 504     | c 17–18       | 1     | 413        | Brick                       | Brick – similar date to floor tile in 504. Three surfaces. Thickness 55mm   |
| 504     | Post-medieval | 5     | 6          | Unknown                     | Five small frags of unknown type with burning on the surface (burnt grey) probably part of the floor tile                               |
| 710     | Post-medieval | 13    | 221        | Brick                       | Amorphous frags of brick with chalk inclusions  |
| 712     | Post-medieval | 8     | 442        | Brick                       | Amorphous frags of brick with chalk grit and flint pebbles  |
| 713     | c 16–17       | 2     | 629        | Brick                       | Two bricks (part of). Two surfaces on each. Thickness 55mm  |
| 2508    | c 18–19       | 2     | 1128       | Brick                       | Two bricks (part of). Regular angles – metal lined stock mould? Three surfaces. Thickness 66mm  |
| 4703    | Post-medieval | 1     | 251        | Brick                       | Brick with pebble inclusions, one surface   |
| 7606    | Roman         | 2     | 64         | Flat tile                   | Burning on lower surface and underfired. Thickness 22mm   |
| 7606    | Undated       | 1     | 4          | Indeterminate               | Amorphous frag – uncertain CBM/FC/stone?  |
| 8903    | Roman         | 1     | 91         | Flat tile                   | burning on base and the broken edge suggest reuse. Thickness 17mm   |
| 10505   | Post-medieval | 1     | 8          | Roof: flat                  |   |
| 10505   | c 18–19       | 1     | 314        | Brick paviour               | Creased surface. Angular edges – metal mould. Two surfaces. Thickness 49mm  |
| 12203   | Post-medieval | 16    | 226        | Brick                       | Amorphous frags of brick with iron oxide inclusions   |
| 14206   | Roman         | 1     | 104        | Flat tile                   | underfired, base missing. Burning on upper surface and heat discoloured. Thickness 23mm   |
| 17209   | c 16–18       | 4     | 159        | Roof: flat                  | Flat tile, red with grey/red core. Thickness 13mm   |
| 18607   | c 14–16       | 1     | 161        | Roof: peg                   | Peg hole uneven (12.8mm diameter). Rough finish. Broken edge worn to a bevel on one corner – reused. Thickness 15mm                     |
| 19804   | Pmed C17-18   | 1     | 291        | Brick                       |   |

| Context | Spot date      | Count | Weight (g) | Form          | Comments  |
|---------|----------------|-------|------------|---------------|---|
| 21406   | Pmed           | 2     | 7          | Indeterminate |   |
| 21408   | Pmed<br>L18-19 | 1     | 67         | Roof: flat    | Fine striations on the top surface and one edge. Early type of extruded tile? |
| 24604   | Pmed           | 3     | 58         | Brick?        | Heavily abraded   |
| 24604   | C14-16         | 1     | 70         | Roof: flat    |   |
| 28306   | Pmed<br>C17-18 | 1     | 17         | Roof: peg     | peg hole (40%) 12mm in diam   |
| 28411   | Pmed<br>C17-18 | 2     | 77         | Roof: flat    |   |
| 30304   | Roman          | 4     | 218        | Tegula        | Tegula (two small frags) and two other heavily abraded frags                  |
| 30304   | Pmed<br>C17-18 | 5     | 122        | Brick         | Heavily abraded   |
| 30304   | Pmed C19       | 1     | 115        | Pipe          | Sewer or drainpipe  |

Table 7: Ceramic building material assemblage

## Conclusions

- B.6.10 The assemblage is moderate in size, and the material is fragmentary but includes a few larger fragments of post-medieval brick and brick paviour.
- B.6.11 The amount of Roman tile is very small, especially when compared to the amount of Roman pottery recovered. The tile occurred as a sparse scatter across the site in Trenches 1, 76, 89, 142 and 303, coinciding with the occurrence of Roman pottery, which spanned the late Iron Age and Roman periods but with the main emphasis on the middle Roman period. Trench 142 is located in the northern part of the rectilinear Roman settlement recorded during the LTC evaluation in Land Parcel 3. Trenches 76 and 89 are located 400m north-west of this settlement. Trench 303 is located 400m north of this settlement. This settlement originated in the late Iron Age/early Roman period with the large enclosure constructed in the middle Roman period (Highways England 2020). Trench 1 is located 500m west of a Roman settlement at Orsett Cock which originated in the late Iron Age and continued in use until the early 4th century (Carter 1988). The flat tile showed signs of burning, which suggests reuse of the material in oven or hearth structures, as does the deflanging of the tegula. The Roman CBM was moderately to heavily abraded suggesting that the material underwent several episodes of disturbance and redeposition before reaching its final resting place. The small quantity of Roman tile recovered compared to pottery is perhaps surprising, as by the middle Roman period one might expect some surplus tile to be filtering down to lower status settlements. It suggests that the Roman settlement just south of the site (Land Parcel 3) and at Orsett Cock may have had no direct links to higher status settlement such as a villa, from which disused tile could be obtained.
- B.6.12 The majority of the assemblage is post-medieval in date. The earliest items are a peg tile and flat roof tile of 14th-16th century date. The peg tile was found in Trench 186, located in the south-eastern part of the site and south of Stanford Road. The flat tile was found in Trench 246, just west of Fen Lane and in the north-western part of the site.
- B.6.13 The post-medieval CBM was found at a number of foci across the site. Almost half of the material recovered was found in Trenches 5 and 7, plus a smaller group from

Trench 25 were located in the north-eastern block of the site, bounded by Stanford Road (A1013), Brentwood Road and Rectory Road. Trench 303 was located just east of Mill Lane and north of the Stanford Road. Trenches 47 and 105 were located in the western part of the site and north of Stanford Road and south of the A13. Trench 122 was located south of the Stanford Road and west of Hornsby Lane. Trenches 172 and 186 were located in the central part of the site and south of Stanford Road. Trenches 198, 214, 283 and 284 were located in the eastern part of the site, north of Stanford Road and north-east and south-east of Barrington's' Farm. These trenches rarely produced more than a single item each (the fragments from Trench 122 probably represent a single shattered brick fragment). Trench 246 contained three fragments of heavily abraded post-medieval brick. This trench was situated west of Fen Lane. Later 19th century OS maps indicate a number of farms and cottages stood along Stanford Road, Rectory Road, Mill Lane, Brentwood Road, Fen Lane, and Hornsby Lane. It is possible that the post-medieval brick and tile originated from some of these farms and cottages. The concentration of CBM in Trenches 5 and 7 possibly relates to a building of 17th-century date in the vicinity, perhaps one which fronted Rectory Road. Elsewhere the post-medieval CBM may represent casual loss, most probably dispersed by agricultural activity.

### **Recommendations**

- B.6.14 The assemblage provides some supplementary dating evidence for the contexts on site but has limited intrinsic research value except perhaps for some tentative association with post-medieval buildings in the locality.
- B.6.15 In general, the archive record together with any items recommended for retention should be sufficient in any wider research encompassing the site or the material. A small selection of diagnostic pieces providing a representative sample of fabrics and forms should be retained as indicated in the archive record. Other material may be discarded upon completion of the project prior to archiving.

## B.7 Metals

By Anni Byard

### Introduction and methodology

B.7.1 A total of 72 metal pieces (638.3g) comprising c 23 objects were recovered during the evaluations (Table 8). This total comprised 71 iron fragments (589.3g) and two of copper alloy (50.9g) from nine contexts across eight trenches. Most of the artefacts are of later post-medieval or early modern date, while three objects may date to the Roman period.

B.7.2 All the metalwork was scanned during the present assessment and where possible century, or broad period dates were assigned. Objects were quantified by type count and weight by context and recorded on a spreadsheet.

| Context | Material       | Count | Weight (g) | Object  | Date    | Description  |
|---------|----------------|-------|------------|---------|---------|--|
| 6804    | Fe             | 10    | 300        | Vessel? | PM/ Mod | Six refitting fragments of a bucket hoop, probably from the top of the bucket. Four small, loose fragments. Probably 19th-early 20th century |
| 10505   | Leather/<br>Fe | 1     | 44.5       | Shoe    | PM/ Mod | Leather boot heel with hobnails.   |
| 10505   | Fe             | 4     | 53.5       | Chain?  | PM/ Mod | Four loops / links, corroded together, plus one loose, incomplete possible oval link.  |
| 10505   | Fe             | 1     | 27.7       |         | PM/ Mod | Heavily corroded rod(s). Uncertain function  |
| 10505   | Fe             | 2     | 12.6       |         | PM/ Mod | Heavily corroded iron fragments including a possible nail  |
| 13403   | Fe             | 38    |            | Vessel? | PM/ Mod | 38 fragments of thin iron sheet. Two pieces have been rolled to create a hollow 'rim'.   |
| 13903   | Cu alloy       | 1     | 1.9        | Coin    | Roman   | Very worn and corroded probable radiate. AD 260–296. SF 1  |
| 13903   | Fe             | 1     | 6.9        |         | Roman?  | Corroded sheet fragment  |
| 13903   | Fe             | 1     | 21.9       |         | Roman?  | Curved bar   |
| 17209   | Fe             | 1     | 32.5       | Ring    | PM/ Mod | Flat, circular iron ring, uneven width and uneven central circular hole. SF 2. Washer-like object, uncertain function. Probable PM /Mod      |
| 17209   | Fe             | 1     | 11         | Nail    |         | Encrusted short rectangular rod, probably a nail shank   |
| 19203   | Fe             | 1     | 21.1       | Rod     |         | Sub-rectangular-sectioned rod or bar, 131mm length. Uncertain function   |

| Context | Material | Count | Weight (g) | Object | Date       | Description   |
|---------|----------|-------|------------|--------|------------|---|
| 19203   | Fe       | 1     | 22         | Rod    |            | Tapering rod of rectangular section, bent. 165mm length. Uncertain function           |
| 19203   | Fe       | 1     | 6.6        | Nail   |            | U-shaped staple, 40mm length.   |
| 19203   | Fe       | 1     | 10.2       | Nail   | PM?        | Rectangular shank with square head  |
| 20204   | Fe       | 4     | 7.9        | Nail   | Query      | Nail fragments, uncertain date  |
| 20205   | Cu alloy | 1     | 49         | Handle | 19th-E20th | Curved bar handle with rounded / scrolled terminals. Screw threads. Cupboard/door etc |
| 20205   | Fe       | 1     | 3          | Nail   | PM?        | Encrusted nail with corroded stem, head not visible                                   |
| 23005   | Fe       | 1     | 6          | Query  | PM?        | Folded bar / strip, uncertain function or date  |

Table 8: Description of metalwork by context

## Discussion

- B.7.3 The metalwork assemblage comprises mostly fragmentary iron objects of later post-medieval or early modern, generally the 19th or early 20th century. A copper alloy Roman coin from Trench 139 is of probable later 3rd century date and the oldest identifiable object in the assemblage. The second copper alloy object, a handle from an item of furniture, is of 19th or early 20th-century date.
- B.7.4 Notable finds include a bucket hoop of six re-fitting pieces from Trench 68 (context 6804). The hoop is formed of an iron band approximately 34mm deep with a folded over section on one edge which is probably the rim of the vessel. This fold creates an internal lip which may have secured wooden staves. No rivet holes were visible on initial inspection. The reassembled hoop has a diameter of 200mm.
- B.7.5 Trench 105 produced the largest amount of metalwork, comprising eight objects. This includes the remains of a leather boot heel (context 10505). Of probable 19th-century date, the heel comprises three pieces of leather, layered, with no obvious stitching holes. The heel retains ten hobnails, of which all heads are broken and missing. The hobnail arrangement appears random. The lack of stitch holes through the leather could suggest adhesive, an early 20th century development. However, the sole could also be nailed through to the upper, a technique developed from the 1860s.
- B.7.6 A collection of four loops or possible chain rings/links were recovered from the same context. These are all corroded into one mass. It is uncertain whether any loops inter-link. The form of link could date anywhere from the Roman to modern era, although the latter is more likely. They may be harness related.
- B.7.7 The remaining three iron objects from Trench 105 (context 10505) are corroded rod fragments, including a possible nail stem.

B.7.8 Trench 139 yielded two iron objects: a curved bar and a corroded sheet fragment of uncertain date. The copper alloy coin recovered from this trench is extremely worn and corroded but is probably a radiate issue of the later 3rd century AD (c AD 260-96). All these objects were recovered from context 13903.

B.7.9 The remaining objects comprise a rod section flat iron ring (possibly a large washer-like object) from Trench 172, and two rod sections, a U-staple and a nail with square head from Trench 192. The staple and nail are likely to be of post-medieval or early modern date. Corroded nail fragments were recovered from Trench 202 and an unidentified folded iron fragment from Trench 230.

B.7.1 Recommendations regarding the conservation, discard, and retention of material

B.7.10 The assemblage is small and generally of modern date. The objects of probable Roman date from Trench 139 should be retained, as should the bucket hoop from Trench 68. The leather shoe fragment and chain links from Trench 10505 should be retained, but the remaining objects from this trench are of little value and have been fully recorded so could be discarded, as could the rest of the assemblage.

## B.8 Glass

By Anni Byard

### Introduction and methodology

- B.8.1 A total of 21 pieces of glass (541.4g) were recovered from seven contexts across six trenches. The assemblage is generally of later 19th or 20th century date (Table 9).
- B.8.2 The glass was scanned during the present assessment and where possible century, or broad period dates were assigned. Shards were quantified by count and weight by context and recorded on a spreadsheet.

| Context | Count | Weight (g) | Object  | Date          | Description   |
|---------|-------|------------|---------|---------------|---|
| 6205    | 5     | 16.4       | Bottle  | 19/20th C     | Shards from the same light green wine bottle. Probably later 19th / 20th century  |
| 12203   | 1     | 34.1       | Bottle  | 18th/19th C   | Basal / heel rim shard from a dark green probable wine bottle.  |
| 13404   | 2     | 30         | Bottle  | 19thC         | Bulbous neck shard from a 19th century cylinder bottle. Dark olive green.   |
| 19203   | 6     | 52         | Bottle  | 19/20th C     | Body shards from a dark olive-green wine bottle. Probably moulded. One fragment appears knapped.  |
| 19203   | 2     | 10.5       | Bottle  | 19/20th C     | Two body shards of clear glass, small milk bottle or similar. The larger fragment appears to have been knapped.   |
| 19203   | 1     | 2.4        | Query   | 19/20th C     | Thick, light aqua blue clear curved shard. Thickness of glass (5mm) suggests later 20th century.  |
| 20205   | 1     | 50         | Bottle  | L19/20th C    | Dark green wine bottle body shard, probably early / mid-20th century  |
| 20205   | 1     | 275        | Window  | Mid-20th C    | Colourless (slight green tint) translucent but not transparent safety glass with narrow diagonal ribbed decoration on one surface. Two straight edges remain. 6.9mm thick. 20th century, probably 1960s |
| 24708   | 1     | 16         | Window  | Mid-20th C    | Thick green tinted window glass, probably a type of safety glass  |
| 24712   | 1     | 55         | Inkwell | L19th/e20th C | Incomplete moulded inkwell missing rim and upper neck. Light green tinted glass. Pen rest slot down one side. Broadly cylindrical but slightly mis-formed. Crude, wavy, bubbly glass, c 1880-1910?      |

Table 9: Description of glass assemblage by context

- B.8.3 Most of the glass comprises wine bottle fragments of olive-green hue. A basal or heel rim shard in a dark green glass with surface weathering is from a wine bottle of later 18th, but more likely, 19th century date. This appears to be the earliest fragment from the evaluation.



- B.8.4 Of note are two shards from Trench 192 (context 19203). In a collection of nine shards from this context, two pieces display probable knapping. This suggests that the fragments were reutilised after their original disposal. Knapped glass of late post-medieval or modern date is recorded from other 18th and 19th-century sites in the UK (in East London) as well as in indigenous communities at historic sites in New Zealand, Australia and America.
- B.8.5 A large fragment of 6.9mm thick ribbed safety glass was recovered from Trench 202. It is likely to be of mid-20th-century date, probably 1960s. A similar piece was recovered from Trench 247.
- B.8.6 Trench 247 yielded a near-complete ink well of late 19th or earlier 20th-century date (c 1880-1910?). The inkwell is moulded in two pieces from a light green tinted glass. The inkwell is broadly cylindrical but is malformed, and has crude, wavy and bubbly glass. The rim and upper section of the neck is missing. A deep vertical groove is likely a pen rest although vertical rests are unusual, with horizontal being the norm.

**Recommendations regarding the conservation, discard, and retention of material**

- B.8.7 Further research and investigation are needed into the glass objects to ascertain if they have been intentionally knapped or if the flaking is a product of some other factor. Should they prove to have been knapped, they should be illustrated and published in a suitable publication and retained.
- B.8.8 The inkwell is an interesting piece due to the vertical rest and could be retained. The remaining glass is of modern date and offers little potential to inform subsequent works so it could be discarded.

## B.9 Worked Stone

By Ruth Shaffrey

- B.9.1 A total of 17 pieces of stone were recovered and submitted for analysis and are summarised below (Table 10). Worked fragments were recovered from four trenches with a variety of other natural material (ferruginous sandstone, greensand and chert) recovered as possible items of worked stone. These were examined with a x10 magnification hand lens for signs of use. Worked or utilised items were recorded, and details entered into a Microsoft Excel spreadsheet.
- B.9.2 A single whetstone was recovered from context 8903. This is made of a grey schist known as Norwegian Rag. Norwegian Rag was the stone type most commonly used for whetstones in Britain from the 9th century onwards (Hansen 2009). It is not found in Roman contexts.
- B.9.3 Fragments of Mayen lava weighing were recovered from contexts 14307, 28413 and 28504. These are too degraded for anything to be said about their form but as Mayen lava is only known to have been imported for use as rotary querns, it is assumed that this was their function. It is likely that they are of Roman date because these were first introduced to Britain at the time of the Roman conquest in AD43 and were widely used thereafter, but Saxon or medieval dates are also possible.

### Recommendations regarding the conservation, discard, and retention of material

- B.9.4 All the unworked stone can be discarded as can the lava fragments, as these are too small to be suitable for geochemical or petrographic analysis. The whetstone should be retained.

| Context | Function     | Notes   | Lithology             |
|---------|--------------|---|-----------------------|
| 8903    | Whetstone    | End portion of rectangular sectioned whetstone with flat faces and edges and sharp arises. Measures >57mm long x 28mm wide x 7-10mm thick | Schist, Norwegian Rag |
| 14307   | Rotary quern | Two degraded fragments  | Mayen lava            |
| 28413   | Rotary quern | Three degraded fragments  | Mayen lava            |
| 28504   | Rotary quern | Three degraded fragments with part of a worked surface  | Mayen lava            |

Table 10: Description of worked stone assemblage by context

## B.10 Slag

by Geraldine Crann

- B.10.1 Fragments of iron slag or associated magnetic material weighing a total of 601g were recovered from six contexts, five in Trench 284, the sixth in Trench 285 (Table 11). The material was weighed and counted, and examined with the naked eye and x10 magnification.
- B.10.2 The quantities in all contexts were small, but did include tap slag from 28411 indicating smelting and spheroids and hammerscale from 28407 indicating smithing. The associated dating is mostly medieval, suggesting medieval ironworking.

| Context | Description  |
|---------|--|
| 28405   | One fragment magnetic slag, 35g                                    |
| 28407   | <27> Thirteen fragments magnetic slag, 8g                          |
| 28407   | <27> 57g of magnetic material including spheroids and hammerscale. |
| 28411   | Five fragments magnetic slag including tap slag, 207g              |
| 28412   | Seven fragments magnetic slag, 163g                                |
| 28413   | Two fragments magnetic slag, 61g                                   |
| 28504   | One fragment magnetic slag, 70g                                    |

Table 11: Description of slag assemblage by context

### Recommendations regarding the conservation, discard, and retention of material

- B.10.3 Although the quantities are small, they are clearly derived from ironworking of medieval and/or post-medieval date, and so should be retained in case they are required for future specialist analysis.

## B.11 Clay Tobacco Pipe

by John Cotter

- B.11.1 Two pieces of clay pipe weighing 6g were recovered from two contexts. These are fully described below.
- B.11.2 Context (22108) Spot-date: Late 18th to 19th century. Description: 1 piece (weight 2g). Stem fragment (length 25mm). Slender with narrow stem bore. Fairly fresh condition.
- B.11.3 Context (30304) Spot-date: 19th century. Description: 1 piece (weight 4g). Stem fragment with trace of a spur (length 43mm). Slender with narrow stem bore. Very fresh condition.

### **Recommendations regarding the conservation, discard and retention of material**

- B.11.4 The pipes here have little potential for further study and could be discarded if so desired.

### C.1 Environmental Samples

By Richard Palmer

#### Introduction

- C.1.1 Thirty bulk samples were collected as part of the evaluation. The aim of sampling was to evaluate the preservation and range of palaeoenvironmental remains across the area and with the intention of recovering environmental evidence of industrial or domestic activity on the Site.

#### Method

- C.1.2 The samples were processed in their entirety at Oxford Archaeology using a modified Siraf-type water flotation machine. The flots were collected in a 250µm mesh and residues in a 500µm mesh and dried. The residue fractions were sorted by eye and with the aid of a magnet, while the flot material was sorted using a low power (x10) binocular microscope to extract cereal grains and chaff, smaller seeds and other quantifiable remains.

#### Results

- C.1.3 Sample summary and flot abundance data is presented in Table 12. Identifications of plant macrofossils are preliminary and taxonomy follows Stace (1997) for wild plants and Zohary *et al* (2012) for cereals.
- C.1.4 **Trench 33.** Sample 1 from fill 3304 of ditch 3303 produced a modest flot. Most of the material has surface concretions, but identification was still possible in most cases. The grain is often fragmented and consists of wheat (*Triticum* sp.) and possible oat (cf. *Avena* sp.). Charred goosefoot seeds are also present (*Chenopodium* sp.), and the recovered glume bases have spelt-like characteristics (*Triticum spelta*). Roman pottery was recovered from the residue.
- C.1.5 **Trench 46.** Sample 26 from fill 4606 of ditch 4605 produced a large flot. The charcoal includes some ring porous fragments and roundwood in the form of twig fragments. Most of the grain is wheat, with a little oat also present. Many legumes of various sizes were also recovered, the largest being about 4mm, and are probably a mix of vetches. A bedstraw seed (*Galium* sp.) was also identified. A little burnt flint was extracted from the residue.
- C.1.6 **Trench 54.** Sample 29 from fill 5404 of pit 5403 produced a poor flot and the residue produced no artefacts.
- C.1.7 **Trench 64.** Sample 30 from fill 6409 of ditch 6408 produced a small flot. The single grain is incomplete but has characteristics of oat (*Avena* sp.). The charred weed seeds include speedwell and dock (*Rumex* sp.) and a few legumes up to 4mm in size are also present. No artefacts were recovered from the residue.
- C.1.8 **Trench 76.** Sample 25 from fill 7604 of pit 7614 produced a large flot. Some of the charcoal fragments are >10mm in size, and multiple species are present in the assemblage. Grain includes barley (*Hordeum vulgare*) and possible wheat. Anglo-Saxon pottery, fired clay and burnt stone were recovered from the residue.

- C.1.9 **Trench 102.** Sample 22 from fill 10205 of pit 10203 produced a flot consisting of a small quantity of charcoal. Possible Iron Age pottery was recovered from the residue.
- C.1.10 **Trench 113.** Sample 3 from fill 11303 of pit 11302 produced a flot consisting of a small quantity of charcoal. No artefacts were recovered from the residue.
- C.1.11 **Trench 136.** The bulk of the samples from this site were collected as spits through three cremation burial cuts encountered in this trench.
- C.1.12 Eight samples were collected from cremation 13609 (samples 8, 11, 12, 15, 18, 20, 21, 24). Seven of them were from fill 13612, which includes spits through the cremation burial and the surrounding material. Sample 21 was from fill 13615, comprising material underlying the cremation deposit. Charcoal was recovered from all samples, some of which is ring porous, and occasional speedwell seeds (*Veronica* sp.) are also present. Calcined bone was recovered from all residues except 20 and 21, and burnt flint was present in multiple residues.
- C.1.13 Four samples were collected from early-middle Bronze Age cremation burial 13610 (samples 4–7), all from fill 13611. Sample 4 was a 50L bulk sample, so the standard 40L was processed as laid out in the method section, with the excess 10L being wet sieved to 500µm to enable bones and artefacts to be recovered. Samples 4, 5 and 6 produced large quantities of charcoal, with a wheat fragment also recovered from sample 5. Calcined bone and burnt flint were recovered from the residues of samples 4, 5 and 6, with no artefacts present in the residue from sample 7.
- C.1.14 Six samples were collected from cremation burial 13613 (samples 10, 13, 16, 17, 19, 23), all from fill 13614. Charcoal was recovered from all samples, some of which is ring porous, and speedwell seeds are present in several. Calcined bone was recovered from the residues of all samples except sample 19, and burnt flint was recovered from several residues.
- C.1.15 **Trench 142.** Sample 14 from fill 14206 of pit 14205 produced a large flot. A significant portion of the charcoal is roundwood in the form of twig fragments, some up to 8mm in diameter and 4–5cm in length. The grain is a mixture of wheat and barley, with wheat glume bases and barley rachis also recovered. The weed assemblage includes dock seeds (*Rumex* sp.) and a number of small Fabaceae, most likely vetches. Burnt flint, pottery and fired clay were recovered from the residue. The deposit is dated to the middle Roman period.
- C.1.16 **Trench 143.** Sample 9 from fill 14310 of ditch 14309 produced a modest flot. The main component of the flot is a terrestrial mollusc assemblage. Bone and slag were recovered from the residue.
- C.1.17 **Trench 148.** Sample 2 from fill 14805 of pit 14804 produced a poor flot. All material is <2mm in size, with a speedwell seed and some small vetch fragments being identified. Burnt flint and fired clay were recovered from the residue. The feature is dated to the early Roman period.
- C.1.18 **Trench 245.** Sample 28 from fill 24504 of ditch 24503 produced a sandy flot. Charred material consists of rare, unquantified, non-diagnostic charcoal flecks smaller than 2mm which may have blown in from a fire at some distance from the feature. No artefacts were recovered from the residue.

C.1.19 **Trench 284.** Sample 27 from fill 28407 of pit 28406 produced a modest flot. The charcoal includes ring porous type and the small number of charred grains include wheat and barley. Slag and hammerscale were recovered from the residue.

### Discussion

C.1.20 In general, there is good potential for the recovery of charred material on site. Available spot dating is limited, partly because many of the samples are from cremations. A terminal early Bronze Age radiocarbon determination was obtained for cremation 13610.

C.1.21 The charred plant remains recovered in the samples provide a broad indication of activities taking place on some parts of the site during the middle Bronze Age- Roman periods. The range of cereals is generally consistent with those typically cultivated in southern England for these periods. There is some evidence indicating the dumping or accumulation of domestic settlement waste particularly in the vicinity of Trenches 33 and 46, but currently samples from these areas are undated. The wild plant seeds recovered are generally those typical of grassland, field margins and arable environments. There is no indication that waterlogged (anaerobic) deposits are present at the site.

C.1.22 The flots from ditches 3303, 4605 and pit 14205 may merit further analysis if securely dated, and should be considered alongside samples recovered from any future excavation. Subsequent analysis for species identification would also be worthwhile for those of the cremation samples that contain at least 100 potentially identifiable charcoal samples once securely dated. Twig roundwood in several samples offer opportunities for radiocarbon dating.

| Sample no. | Context no. | Feature/<br>deposit | Date | Sample vol.<br>(L) | Flot vol. (ml) | Charcoal<br>>2mm | Grain | Chaff | Weeds | Molluscs | Other | Notes                     |
|------------|-------------|---------------------|------|--------------------|----------------|------------------|-------|-------|-------|----------|-------|---------------------------|
| 1          | 3304        | 3303                | RB   | 40                 | 50             | ++               | +++   | +++   | ++    |          |       | 10YR 5/2 silty clay       |
| 2          | 14805       | 14804               | ERB  | 3                  | 5              |                  |       |       | +     |          | +     | 7.5YR 4/4 sandy clay loam |
| 3          | 11303       | 11302               |      | 16                 | 25             | ++               |       |       |       |          |       | 10YR 4/4 sandy silt loam  |
| 4          | 13611       | 13610               | MBA  | 40                 | 200            | ++++             |       |       | +     |          |       | 7.5YR 3/2 sandy silt loam |
| 5          | 13611       | 13610               | MBA  | 35                 | 150            | ++++             | +     |       |       |          |       | 7.5YR 3/2 sandy silt loam |
| 6          | 13611       | 13610               | MBA  | 10                 | 25             | +++              |       |       |       |          |       | 7.5YR 3/2 sandy silt loam |
| 7          | 13611       | 13610               | MBA  | 10                 | 5              | +                |       |       |       |          |       | 7.5YR 3/2 sandy silt loam |
| 8          | 13612       | 13609               |      | 40                 | 200            | ++++             |       |       | ++    |          |       | 7.5YR 3/4 silt loam       |
| 9          | 14310       | 14309               |      | 40                 | 50             | ++               |       |       |       | +++      |       | 7.5YR 4/6 loamy sand      |
| 10         | 13614       | 13613               |      | 4                  | 50             | +++              |       |       | +     |          |       | 10YR 3/3 sandy silt loam  |
| 11         | 13612       | 13609               |      | 30                 | 150            | ++++             |       |       | +     |          |       | 10YR 3/3 sandy silt loam  |
| 12         | 13612       | 13609               |      | 30                 | 200            | ++++             |       |       | +     |          |       | 10YR 3/4 sandy silt loam  |

| Sample no. | Context no. | Feature/<br>deposit | Date        | Sample vol.<br>(L) | Flot vol. (ml) | Charcoal<br>>2mm | Grain | Chaff | Weeds | Molluscs | Other | Notes                                |
|------------|-------------|---------------------|-------------|--------------------|----------------|------------------|-------|-------|-------|----------|-------|--------------------------------------|
| 13         | 13614       | 13613               |             | 5                  | 25             | +++              |       |       |       |          |       | 10YR 4/4 sandy silt loam             |
| 14         | 14206       | 14205               | LIA-MRB     | 18                 | 210            | ++++             | ++    | +     | +++   |          |       | 7.5YR 3/2 sandy loam                 |
| 15         | 13612       | 13609               |             | 20                 | 50             | +++              |       |       | +     |          |       | 10YR 3/4 sandy silt loam             |
| 16         | 13614       | 13613               |             | 8                  | 20             | ++               |       |       | +     |          |       | 7.5YR 4/4 sandy silt loam            |
| 17         | 13614       | 13613               |             | 5                  | 5              | ++               |       |       |       |          |       | 7.5YR 4/4 sandy silt loam            |
| 18         | 13612       | 13609               |             | 5                  | 10             | ++               |       |       |       |          |       | 10YR 3/3 sandy silt loam             |
| 19         | 13614       | 13613               |             | 4                  | 5              | +                |       |       | +     | +        |       | 10YR 4/6 sandy silt loam             |
| 20         | 13612       | 13609               |             | 3                  | 10             | ++               |       |       | +     |          |       | 7.5YR 3/4 sand                       |
| 21         | 13615       | 13609               |             | 10                 | 10             | +                |       |       | +     |          |       | 10YR 4/3 sandy silt loam             |
| 22         | 10205       | 10203               | IA          | 18                 | 25             | ++               |       |       |       |          |       | 7.5YR 5/4 silty clay loam            |
| 23         | 13614       | 13613               |             | 8                  | 10             | +                |       |       | +     |          |       | 7.5YR 4/6 sand                       |
| 24         | 13612       | 13609               |             | 20                 | 10             | ++               |       |       | +     |          |       | 7.5YR 4/6 sand                       |
| 25         | 7604        | 7614                | LIA-MRB/Sax | 36                 | 375            | ++++             | ++    |       | +     |          |       | 7.5YR 4/4 loamy sand                 |
| 26         | 4606        | 4605                |             | 38                 | 100            | ++++             | ++++  |       | +     |          | +++   | 10YR 4/3 loamy sand                  |
| 27         | 28407       | 28406               |             | 16                 | 30             | ++++             | +     |       |       | +        |       | Orangey brown clayey silt            |
| 28         | 24505       | 24503               |             | 40                 | 25             |                  |       |       |       |          |       | Greyish and reddish brown silty clay |
| 29         | 5404        | 5403                | MBA-IA      | 25                 | 2              | +                |       |       |       |          |       | Greyish brown clayey silt            |
| 30         | 6409        | 6408                |             | 8                  | 10             | +++              | +     |       | ++    |          | +     | Greyish brown sandy silt             |

Key: +=present (up to 5 items), ++=frequent (5-25), +++=common (25-100), ++++=abundant (100+)

Table 12: Assessment of bulk samples



## C.2 Animal Bone

By Rebecca Nicholson and Adrienne Powell

### Introduction and methodology

- C.2.1 An estimated total of 153 animal bone fragments (number taking into account refitting fragments which are scored as 1 bone), weighing 838g, was recovered from the site (Table 13), all of which was collected by hand. Features on the site were dated based on associated ceramic finds, most of which were Roman, medieval or post-medieval. The bone came from 24 contexts in Trenches 5, 42, 43, 45, 72, 90, 104, 112, 114, 122, 142, 143, 172, 186, 214, 244, 247, 284 and 303.
- C.2.2 The animal bone was recorded in full, with the aid of the Oxford Archaeology skeletal reference collection and standard identification guides, using a diagnostic zone system (Serjeantson 1996). Bone condition was recorded on a semi-quantitative scale of 1 (as fresh) to 5 (extremely poor, corroded and crumbly). Where condition was difficult to score (eg burnt bone and teeth) condition was recorded as 0. Measurements were taken following von den Driesch (1976). Tooth wear was recorded following Grant (1982). Full records will be lodged with the site archive.

### Description

- C.2.3 Bone preservation varies depending on trench and period but, if considered by the number of fragments exhibiting each condition, then is typically fair–good (condition 2–3). This is, however, skewed by the presence of a partially complete and well-preserved foetal calf from 11207. The bone from contexts 9003, 10403 and 10405 are extremely eroded (condition 5), and only fragments of tooth enamel were recovered from 4312. No burnt bone was recovered. A mole (*Talpa europaea*) humerus from 14310 is in extremely good condition and is very probably intrusive, as is a small mammal metapodial from 7206.
- C.2.4 Notable elements of the assemblage include the partially complete foetal calf from ditch fill 11207. The majority of bone fragments are post-cranial, some of the head, including the mandible and maxilla, is missing. All epiphyses are unfused, and there is one example where metacarpal/metatarsal III and IV have not yet fused together. This burial accounts for 14 of the identified bones, as well as an estimated 45 indeterminate fragments. Two large mammal cervical vertebrae from animals of different sizes were also recovered from the same context.
- C.2.5 No bones were butchered, and no pathologies were observed. Other than the partial skeleton, there is no evidence for juvenile animals at the site and little ageing evidence at all. A loose cattle M3 from context 4208 is at Grant's (1982) wear stage k, equating to an elderly/senile animal (Halstead 1985, 219), a cattle acetabulum from context 4504 is fused, indicating an animal older than 7-10 months (Silver 1969) and a cattle left horn core base from context 24405 shows closure of the frontal-parietal suture, indicating an adult animal. Measurements on the horn core (basal circumference = 119mm, greatest diameter = 42.5mm, least diameter = 35.4mm) suggest it was from a small individual. Two sheep/goat bones, a distal humerus from context 18607 and a metacarpal from context 21408, were also fused, indicating animals older than 10 months and 18-24 months respectively. The metacarpal was the only other specimen in the assemblage which could be measured: the proximal breadth = 24.3mm, proximal depth = 17.8mm and shaft depth = 17.3mm.

| Context      | Period      | Cattle    | Horse    | Sheep/goat | Mole     | Large mammal | Medium mammal | Small mammal | Indet. Mammal | TOTAL      |
|--------------|-------------|-----------|----------|------------|----------|--------------|---------------|--------------|---------------|------------|
| 504          |             |           |          |            |          | 1            |               |              |               | 1          |
| 4208         | 13-15th C   | 1         |          |            |          |              |               |              |               | 1          |
| 4312         |             |           |          |            |          |              |               |              | 7             | 7          |
| 7206         | prehistoric |           |          |            |          |              |               | 1            |               | 1          |
| 4504         |             | 1         |          |            |          |              |               |              |               | 1          |
| 9004         |             | 1         |          |            |          |              |               |              |               | 1          |
| 10403        | Roman       |           |          |            |          | 1            |               |              |               | 1          |
| 10405        | 13-14th C   |           |          |            |          |              |               |              | 50*           | 50         |
| 11207        | Roman       | 14        |          |            |          | 2            |               |              | 45*           | 61         |
| 11403        |             |           |          |            |          |              | 10            |              |               | 10         |
| 12203        |             |           |          |            |          | 1            |               |              |               | 1          |
| 14204        | Roman       |           | 1        |            |          |              |               |              |               | 1          |
| 14310        |             |           |          |            | 1        |              |               |              |               | 1          |
| 17205        | Roman       |           |          |            |          |              | 2             |              |               | 2          |
| 18607        |             |           |          | 1          |          |              |               |              |               | 1          |
| 21408        | 19th C      |           |          | 1          |          |              |               |              |               | 1          |
| 24405        |             | 1         |          |            |          |              |               |              | 3             | 4          |
| 27408        |             |           |          |            |          | 1            |               |              |               | 1          |
| 28411        |             |           |          | 1          |          | 1            |               |              | 4             | 6          |
| 30304        |             |           |          |            |          | 1            |               |              |               | 1          |
| <b>TOTAL</b> |             | <b>18</b> | <b>1</b> | <b>3</b>   | <b>1</b> | <b>8</b>     | <b>12</b>     | <b>1</b>     | <b>109</b>    | <b>153</b> |

\*= small fragments, estimated number

Table 13: Animal bone assemblage, number of fragments by context and taxon

## Conclusions

- C.2.6 Animal bone is clearly present on site in the areas excavated, but it is possible that the calf from context 11207 is of later date than the ceramics within the fill, since the bone is fairly well-preserved despite being immature.

### Recommendations regarding the conservation, disposal or retention of material

- C.2.7 The bone assemblage is small and has been recorded in full. Retention in the archive is not considered to be a priority.

## C.3 Human Remains

By Helen Webb

### Introduction and provenance

- C.3.1 All deposits were recovered, processed and analysed in accordance with published guidelines (McKinley 2004).
- C.3.2 The human bone recovered from the archaeological evaluation at land bordering the A13 at Orsett, Essex (LTC3020), comprised three unurned deposits of cremated bone (13611 from pit 13610, 13612 from pit 13609 and 13614 from pit 13613). A small quantity of bone was also recovered from the primary fill (13615, sample 21) of pit 13609. This clearly originated from overlying deposit 13612, thus it is therefore included with this deposit.
- C.3.3 All three pits, which were closely adjacent to one another, were revealed within the south-eastern half of Trench 136. Immediately to the south-east of the cremation features were NE–SW aligned gully 13603 and ditch 13605.
- C.3.4 The largest of the three pits was 13610 (containing deposit 13611). This feature was roughly oval, measuring 1.10m in width with a depth of 0.20m. Deposit 13611 comprised a dark brown, loose clay-sand with charcoal, as well as fired flint fragments. Heat-affected natural was noted on the south-west edge of the feature.
- C.3.5 Pit 13613, the smallest of the three pits, measured 0.34m by 0.26m, with a depth of 0.09m. The fill (13614) comprised a soft, dark grey-black (charcoal-rich) sandy silt with frequent burnt bone. Pit 13609, immediately adjacent to the south-east of 13613, measured 0.87m by 0.65m, with a depth of 0.20m. This pit contained very dark grey-brown clayey sand, with occasional burnt flint/stone fragments and frequent charcoal. During excavation it was not clear, initially, that 13609 and 13613 were separate features, the upper fills (13612 and 13614) being mixed on the surface.
- C.3.6 All three of the pits were affected by plough truncation and this was probably the cause of the mixing of deposits 13612 and 13614. The features also suffered slight machine truncation.
- C.3.7 None of the cremation deposits yielded any artefacts, but cremated bone from layer 13611, the lowest fill in pit 13610, was submitted for radiocarbon dating, and gave a date range of 1690-1510 cal BC at 95% confidence (SUERC-96933; 3328 ± 24 BP). The other two cremations, which were also in the same trench, are also likely to be of similar date.

### Methodology

- C.3.8 All deposits were recovered, processed and analysed in accordance with published guidelines (McKinley 2004).
- C.3.9 The deposits were subject to whole earth recovery in the field, before being processed and analysed. Each feature was excavated in a series of spits, but for the purposes of analysis the spit-data was combined for each deposit. It should be noted here that the mixed material from the initial excavation of deposits 13612 and 13614 (prior to them being identified as separate features) was treated entirely separately from the rest of the deposits.

- C.3.10 Processing involved wet sieving the deposits, which sorted them into fractions of >10mm, 10–4mm, 4–2mm and 2–0.5mm. The >10mm and 10–4mm sieve fractions were fully sorted, separating the burnt bone from the extraneous material (e.g. stones). It was not viable to fully sort the 4–2mm fractions (some of the 4–2mm material from deposits 13612 and 13614 were sorted). Instead, a sample from each of these unsorted fractions was sorted and the percentage bone weight calculated. These percentages were then applied to the total weights of the unsorted samples to give an estimated bone weight for each. These estimated bone weights were as follows: 158.7g (deposit 13611); 63.3g (deposit 13612, in addition to 5.9g sorted); 20.8g (deposit 13614, in addition to 2.3g sorted); 34.4g (mixed deposit 13612/13614). These estimated weights are included in the total weights presented below.
- C.3.11 The smallest fraction sizes (2–0.5mm) were not sorted but were rapidly scanned for identifiable skeletal remains and artefacts. Estimations of the proportions of bone present within the 2–0.5mm fractions were made visually and are noted in the results below.
- C.3.12 All bone was analysed to record colour, weight and maximum fragment size. Total bone weights presented do not include bone from the 2–0.5mm fraction but do include the weight estimates calculated for the 4–2mm fractions.
- C.3.13 Each sieve fraction was examined for identifiable bone elements and the presence of pyre and/or grave goods. The minimum number of individuals (MNI) present was estimated based on the identification of repeated elements and/or the presence of juvenile and adult bones in the same deposit. Estimations of age were based on the development stage of tooth roots (Moorrees et al 1963; AlQahtani 2009), observations of completely fused epiphyses (Scheuer and Black 2000) and, more generally, the overall size/morphology of identified bones. No indicators of sex were identified.

## Results

- C.3.14 Full details of the osteological analysis are available in the archive.
- C.3.15 A summary of the osteological findings for each deposit is presented in Table 14. Because it was not possible to ascertain how much of the material comprising mixed deposits 13612 and 13614 came from each deposit, the data for the mixed material is presented separately.

| Context  | >10mm             | 10–4mm            | *4–2mm            | Total weight*    | Maximum fragment size    | Identified elements   | Colour               | MNI, age, sex                                    |
|--|-------------------|-------------------|-------------------|------------------|--------------------------|---|----------------------|--|
| 13611  | 375.2g<br>(44.4%) | 310.2g<br>(36.7%) | 158.7g<br>(18.8%) | 844.1g<br>(100%) | 62mm<br>(femur shaft)    | Skull vault, temporal frags (inc. petrous), maxilla, mandible, tooth roots, ribs, vertebral body/arch frags, humerus, radius, ulna, hand phalanx (prox), innominate, femur, patella, tibia, fibula                              | White<br>100%        | MNI = 1<br>Adult/adolescent<br>(>13 yrs)<br>?sex |
| **13612  | 310.7g<br>(56.7%) | 168.0g<br>(30.7%) | 69.2g<br>(12.6%)  | 547.9g<br>(100%) | 61mm<br>(?tibia shaft)   | Skull vault, maxilla, vertebral arch frags, sacrum, ribs, humerus, radius, ulna, carpal frag, hand phalanges, innominate, femur, patella, tibia, fibula, lateral cuneiform, metatarsal frags, foot sesamoid                     | White 99%<br>Grey 1% | MNI = 1<br>Adult/adolescent<br>(>13 yrs)<br>?sex |
| 13614  | 49.9g<br>(42.4%)  | 44.7g<br>(38.0%)  | 23.1g<br>(19.6%)  | 117.7g<br>(100%) | 47mm<br>(clavicle)       | Skull vault, loose sutural ossicle, temporal bone, maxilla, mandible (inc. L + R ramus, condyle frag), vertebral arch frags (inc. cervical vertebra), ribs, clavicle  | White<br>100%        | MNI = 1<br>Adult/adolescent<br>(>13 yrs)<br>?sex |
| Mixed deposit<br>(upper portions of 13612/13614) | 81.8g<br>(35.7%)  | 113.2g<br>(49.3%) | 34.4g<br>(15.0%)  | 229.4g<br>(100%) | 50mm<br>(?humerus shaft) | Skull vault, temporal bone (inc. petrous frag), maxilla, tooth roots (at least x4 teeth), vertebral arch frags, ribs, scapulam humerus, radius (inc. head frag), distal hand phalanx, femur, tibia, fibula, distal foot phalanx | White<br>100%        | MNI = 1<br>Adult/adolescent<br>(>13 yrs)<br>?sex |

\*All 4–2mm and total weights include the estimated 4–2mm weights (see Methods)

\*\*Weights for 13612 include the small quantity of bone from primary fill 13615 (4–2mm only)

Table 14: Summary of osteological findings

### *Bone weights*

- C.3.16 At 844.1g, the total weight of deposit 13611 falls well below the expected range for modern cremation deposits (1000–2400g, with an average of 1650g, McKinley 2000, 269). However, it does fall within the range for archaeologically recovered cremation deposits (600–900g, McKinley 2013, 154). It should be reiterated here that the deposit was affected by plough truncation, as well as probable slight machine truncation, and it is not known how much of the deposit may have been lost.
- C.3.17 Discrete deposit 13612 totalled 547.9g, whilst discrete deposit 13614 weighed just 117.7g. The mixed deposit, comprising a combination of the upper fills of 13612 and 13614, totalled 229.4g. As noted above, it was not possible discriminate between material from 13612 and 13614 within the mixed deposit, thus the total weights of each remain inconclusive. Furthermore, these features were also subject to plough, and probably also machine, truncation.

### *Fragmentation*

- C.3.18 In all three deposits, as well as the mixed material from 13612/13614, the largest proportions of bone were from the >10mm fractions. In deposit 13611, 44.4% of the total weight comprised fragments that were >10mm, compared with 56.7% in deposit 13612, 42.4% in deposit 13614 and 35.7% in mixed deposit 13612/13614. The smallest proportions of bone in all deposits, came from the 4–2mm fractions (18.8% in 13611, 12.6% in 13612, 19.6% in 13614 and 15.0% in the mixed material from 13612/13614).
- C.3.19 The largest bone fragments from each deposit were a 62mm length of femur shaft (13611), a 61mm length of probable tibia shaft (13612), a clavicle fragment measuring 47mm (13614) and a probable humerus shaft fragment measuring 50mm (mixed deposit 13612/13614).
- C.3.20 The unsorted 2–0.5mm residues all contained low, or very low, quantities of bone. Based on visual assessment, the estimated bone content (by volume) ranged from c 1% (discrete deposits 13612 and 13614, and mixed material from 13612/13614) to 5% (deposit 13611).

### *Skeletal Representation*

- C.3.21 Table 15 outlines the bone weights per skeletal region (skull, axial, upper limb, lower limb) as well as the unidentified bone weight, per deposit.

| Element/Context  | 13611                | 13612                | 13614                | Mixed deposit (13612/13614) |
|------------------|----------------------|----------------------|----------------------|-----------------------------|
| Skull            | 150.0g (17.8%)       | 0.6g (0.1%)          | 66.5g (56.5%)        | 23.1g (10.1%)               |
| Axial            | 27.9g (3.3%)         | 23.3g (4.3%)         | 3.3g (2.8%)          | 3.0g (1.3%)                 |
| Upper limb       | 58.5g (6.9%)         | 66.6g (12.2%)        | 3.2g (2.7%)          | 28.2g (12.3%)               |
| Lower limb       | 112.5g (13.3%)       | 111.8g (20.4%)       | / (0%)               | 15.9g (6.9%)                |
| Total identified | 348.9g (41.3%)       | 202.3g (36.9g)       | 73.0g (62.0%)        | 70.2g (30.6%)               |
| Unidentified     | 495.2g (58.7%)       | 345.6g (63.1%)       | 44.7g (38.0%)        | 159.2g (69.4%)              |
| <b>Total</b>     | <b>844.1g (100%)</b> | <b>547.9g (100%)</b> | <b>117.7g (100%)</b> | <b>229.4g (100%)</b>        |

Table 15: Bone weights per body region

- C.3.22 Of the total weight, 41.3% (348.9g) of deposit 13611 could be identified to skeletal element. Skull fragments, including cranial vault, temporal bone fragments (including a petrous fragment), maxilla, mandible, tooth roots, made up 17.8% of the total bone weight, or 43% (150.0g/348.9g), of the identified bone weight. Skull fragments often

make up a significant proportion of identified bone weights because they are easily identifiable, even amongst the smaller fractions. Lower limb bone fragments, including innominate, femur, patella, tibia and fibula fragments, made up the next largest proportion of identified bone (13.3% of the total deposit weight, or 32.2% (112.5g/348.9g) of the identified bone). Upper limb bone fragments (humerus, radius and ulna fragments, and a proximal hand phalanx) and axial bone fragments (ribs and vertebral body/arch fragments) made up far smaller proportions of the identified bone (16.8% (58.5g/348.9g) and 8.0% (27.9g/348.9g) respectively). Axial bone fragments often make up only a small proportion of the total bone weight, not only because they weigh proportionally less within a complete skeleton, but because they are made up largely of trabecular (spongy) bone, which does not survive as well in the burial environment. Unidentified bone fragments made up over half (58.7%) of the total weight of the deposit, and almost 30% of the unidentified bone comprised unidentified long bone fragments, a common finding in archaeological cremation deposits.

- C.3.23 The distribution of bone by skeletal region within deposits 13612 and 13614 is interesting. Whilst the mixing of the upper parts of these deposits precludes any firm conclusions to be made regarding the proportions of bone per skeletal region (i.e. because it is unclear how much of each skeletal region identified within the mixed material relates to either deposit 13612 or deposit 13614), it is notable that only a very small quantity of skull fragments (including cranial vault and maxilla) was identified in discrete deposit 13612 (0.6g, making up 0.1% (0.6g/547.9g) of the total weight, or 0.3% (0.6g/202.3g) of the identified bone weight). Conversely, the majority of the identified bone in discrete deposit 13614 comprised skull fragments (66.5g, making up 56.5% (66.5g/117.7g) of the total weight, or 87.5% (66.5g/73.0g) of the identified bone weight). These included cranial vault fragments, a loose sutural ossicle, temporal bone fragments, maxilla and mandible fragments (including left and right ramus, and a condyle fragment). Further, the identified bone from deposit 13612 largely comprised lower limb bone fragments (111.8g, making up 20.4% (111.8g/547.9g) of the total weight, or 55.3% (111.8g/202.3g) of the identified bone weight), including femur, patella, tibia and fibula fragments, a partial lateral cuneiform, metatarsal fragments and a probable foot sesamoid. No lower limb bone fragments were identified in 13614 at all. All skeletal regions were represented within the mixed material from deposits 13612 and 13614.

#### *Colour of the cremated bone*

- C.3.24 The colour of cremated bone reflects the degree of oxidation and is thus an indication of the efficiency of the cremation, in terms of the quantity of fuel used to build the pyre, the temperature attained in various parts of the pyre, and the length of time over which the cremation was undertaken (McKinley 2004, 11). Colour may range from brown/orange (unburnt), to black (charred: c 300°C), through hues of blue and grey (incompletely oxidised, up to c 600°C) to white (fully oxidised, >600°C) (*ibid.*).
- C.3.25 The burnt bone from all deposits was completely white (calcined), with the exception of a few fragments (c 1%) in deposit 13612, which were light grey in colour. Amongst the grey coloured fragments was a distal hand phalanx.

#### *Demography*

- C.3.26 In the absence of any obvious repeated elements, the minimum number of individuals (MNI) represented in each deposit was one.

C.3.27 In all three discrete deposits (13611, 13612, 13614), the size, thickness and morphology of the bones was in keeping with adult, or possibly adolescent, remains. although there were no precise indicators of age. In deposit 13611 and mixed deposit 13612/13614 a number of tooth roots were observed. Most of these were incomplete/fragmented, and therefore unidentified, but where the apices were observable, these were all complete. No more precise indicators of age were present within the deposits, nor were there any indicators of sex.

#### *Pathology and non-metric traits*

C.3.28 Non-metric traits are minor anomalies of skeletal anatomy that may be environmentally or genetically induced (Mays 1998; Tyrrell 2000). The only non-metric trait observed was a loose sutural ossicle within deposit 13614. Some variations in the sutures of the skull, such as lambdoid ossicles, have been proven to be under significant genetic control (Torgersen 1951a; 1951b; 1954; Sjøvold 1987).

C.3.29 No lesions of pathology were observed.

#### *Pyre/grave goods*

C.3.30 No evidence for pyre or grave goods was identified within any of the deposits.

### **Discussion**

C.3.31 The human bone assemblage comprised three unurned cremation deposits (13611, 13612, 13614) from earth-cut pits, as well as a deposit collected separately, comprising the mixed upper fills of deposits 13612 and 13614. Deposit 13611 was dated to the transition from the early-middle Bronze Age; the other two cremations have not been radiocarbon dated, but are likely to belong to the same period.

C.3.32 Each of the deposits had an MNI of one, and in all cases the remains were in keeping with adult, or possibly adolescent, remains, although no precise age, or sex, estimations could be made. No pathological lesions were observed.

C.3.33 With a total weight of 844.1g, deposit 13611 was the largest. This also came from the largest of the pit features (1.1m wide). Although the weight falls within the range expected for archaeologically recovered deposits (600–900g, McKinley 2013, 154), it is unknown how much bone may have been lost as a result of disturbance/truncation. Aside from cremated bone, the deposit also included pyre debris, with the surrounding matrix also including charcoal and burnt stone fragments. The observation, during excavation, that the natural around the south-western edge of the deposit was heat-affected, indicates that the remains were still very hot when they were deposited, presumably having been tipped into the pit from this side. It was considered that the feature may have represented the very base of an *in situ* cremation pyre pit, the upper part having been truncated by plough/machine, but this seems unlikely given that only the south-western edge of the remaining feature exhibited evidence for heating.

C.3.34 Interpretation of deposits 13612 and 13614 is difficult. As noted above, the upper fills were mixed on the surface, it only becoming apparent that there were two separate features as the upper parts of the deposits were removed. The total weights of the discrete deposits were 547.9g (13612) and 117.7g (13614), both below the expected range for archaeologically recovered cremation deposits (see above, McKinley 2013, 154). However, a significant quantity of bone (229.4g) was recovered from the mixed material and it is not known how much of this derived from each deposit.



- C.3.35 When the proportions of each skeletal region represented within the discrete deposits (13612 and 13614) were calculated, an interesting pattern was noted. An unusually low proportion of skull fragments was noted in deposit 13612, compared with a notably high proportion of skull fragments within deposit 13614. Conversely, a notably high proportion of lower limb bones was identified in deposit 13612, with no lower limb bones positively identified within 13614 at all. It is, of course, unclear how the quantities of skull and lower limb bone fragments within the mixed material from these deposits would affect these figures, but it is tempting to suggest that the two features may in fact contain remains from the same individual, the different skeletal regions being split between the features. It is assumed that the mixing of deposits 13612 and 13614 simply occurred due to plough disturbance of two closely adjacent pits. Whilst this seems like the most likely scenario, it should not be discounted that the apparently separate features were in fact all that remained of a single feature, appearing falsely as separate features due to a markedly undulating base and the sides of the pit largely being lost due to truncation by ploughing. If this were the case, then the observed patterns in skeletal representation between deposits 13612 and 13614 would indicate that the remains had been placed in some sort of order within the feature.
- C.3.36 As with 13611, both 13612 and 13614 contained charcoal and burnt stone, indicating that pyre debris formed part of the deposit/s. The south-western edge of pit 13609 (containing 13612) also comprised heat-affected natural, as seen in pit 13610 (containing 13611). As noted above, this indicates that the material was hot when it was deposited. If none of these features are *in situ* pyre pits (indeed, the archaeology does not seem to support this), then the pyre site/s must have been nearby, the remains having been buried quickly after the end of the cremation process.
- C.3.37 Overall, the bones from all deposits were predominantly white (fully oxidised). This indicates that the corpse/s would have been placed on the pyre in such a way as to maintain a consistent high temperature and oxygen supply (McKinley 2013, 158), enabling a temperature in excess of 600°C (McKinley 2004, 11). A high proportion of fully oxidised bone is a common observation in archaeological cremation burials (McKinley 2006, 84). The few non-white fragments in deposit 13612, representing lower temperatures, included a hand phalanx and it may be that these elements were closer to the edges of the pyre, where such high temperatures had perhaps not been reached.
- C.3.38 It is recommended that these remains are retained for future research, given the potential for further works in the surrounding area, at which point it may be beneficial to carry out radiocarbon dating. Dating would allow for further discussion of their significance in the archaeological record. All deposits have suitable fragments for dating.
- C.3.39 The assemblage is currently held at Oxford Archaeology under Ministry of Justice burial licence 19-0317. This licence is valid until 8th December 2025, by which time the remains must have been reburied. In the event that the remains are not ready for reburial by this time the licence should be deferred by application to the Ministry of Justice. Deferring the licence so that the human bone can be deposited with a local museum is recommended, considering the future research potential.

## C.4 Radiocarbon dating

By Rebecca Nicholson

- C.4.1 A single sample of cremated human bone, comprising a probable femur fragment from context 13611 was submitted to the Scottish Universities Environmental Research Centre (SUERC) for radiocarbon dating by Accelerator Mass Spectrometry (AMS). The sample was processed using the methods described in Dunbar et al (2016). The laboratory maintains a continuous program of internal quality control in addition to participation in international inter-comparisons (Scott et al 2010). These tests indicate no laboratory offset and demonstrate the validity of the precision quoted.
- C.4.2 The reported result is a conventional radiocarbon age (Stuiver and Polach 1977) corrected for total fractionation effects and quoted in accordance with the international standard known as the Trondheim convention (Stuiver and Kra 1986). Calibration was performed using OxCal 4.4.4 and INTCAL20 (Bronk Ramsey 2009, 2021; Reimer et al. 2020) with the end points rounded outwards to 5 years and quoted in the form recommended by Mook (1986).

| Lab. reference        | Sample | Context | Material                     | $\delta^{13}\text{C}$ (‰) | Radiocarbon Age (BP) | Calibrated date (at 95.4%)                         |
|-----------------------|--------|---------|------------------------------|---------------------------|----------------------|--|
| SUERC-96933 (GU57271) | n/a    | 13611   | Cremated human bone cf femur | -20.1                     | 3328 ±24             | 1685-1650 cal BC (5.3%), 1645-1515 cal. BC (90.1%) |

Table 16. Radiocarbon sample detail and calculated age range

- ACBMG, 2007 *Ceramic building material, minimum standards for recovery, curation, analysis and publication*, Archaeological Ceramic Building Materials Group
- Allen, T with Evans, G, forthcoming The medieval kitchen and demolished south range at Headstone Manor, Harrow, Middlesex, and other discoveries during watching brief 2016-2017, LAMAS
- Bamford, H, 1985 *Briar Hill: excavation 1974–1978*. Northampton: Northampton Development Corporation Archaeol Monogr **3**
- BGS, 2020 *Geology of Britain Viewer*. Retrieved from <http://mapapps.bgs.ac.uk/geologyofbritain/home.html>
- Biddulph, E, 2010 The Roman pottery, in E. Biddulph, K. Brady, B. M. Ford and P. Murray, Roman settlement, pottery production and a cemetery in the Beam valley, (Dagenham), *Trans Essex Soc Archaeol Hist* **1**, 121–9
- Biddulph, E, 2015 Pottery production at Heybridge, in M. Atkinson and S. J. Preston, Heybridge: a late Iron Age and Roman settlement, excavations at Elms Farm 1993–5, volume 2. *Internet Archaeology* **40**, <http://dx.doi.org/10.11141/ia.40.1.biddulph>
- Biddulph, E, Compton, J, and Martin, T S, 2015 The late Iron Age and Roman pottery, in in M. Atkinson and S. J. Preston, Heybridge: a late Iron Age and Roman settlement, excavations at Elms Farm 1993–5, volume 2. *Internet Archaeology* **40**, <http://dx.doi.org/10.11141/ia.40.1.biddulph1>
- Bettley, B and Pevsner, N, 2007 *The Buildings of England, Essex*
- Bonsall, C, 1978 The flint industry, in J. Hedges and D. Buckley, Excavations at a Neolithic causewayed enclosure, Orsett, Essex, 1975. *Proc Prehist Soc* **44**, 255–9
- Bronk Ramsey, C, 2009 Bayesian analysis of radiocarbon dates, *Radiocarbon* **51**(1), 337–360
- Bronk Ramsey, C, 2021 OxCal Web interface build number: 132 Last Updated: 1/3/2021
- Brudenell, M, 2016a Late Bronze Age pottery, in Evans *et al.* 2016, 158–88
- Brudenell, M, 2016b Middle Iron Age pottery, in Evans *et al.* 2016, 365–93
- Butler, C, 2005 *Prehistoric flintwork*. Stroud: Tempus
- Carter, G, 1998 Excavations at the Orsett `Cock' Enclosure, Essex, 1976. Essex County Council: East Anglian Archaeology **86**
- ClfA, 2014a *Standard and guidance for archaeological evaluation*. Updated October 2020. Chartered Institute for Archaeologists. Retrieved from <http://archaeologists.net/sites/default/files/node-files/IfASG-Evaluation.pdf>

- CIfA, 2014b *Standard and guidance for the creation, compilation, transfer and deposition of archaeological archives*. Revised October 2020. Chartered Institute for Archaeologists. Retrieved from:  
[https://www.archaeologists.net/sites/default/files/CIFAS%26GArchives\\_4.pdf](https://www.archaeologists.net/sites/default/files/CIFAS%26GArchives_4.pdf)
- Cheer, P, 1998 The kiln pottery, in G. A. Carter, *Excavations at the Orsett 'Cock' enclosure, Essex, 1976*, *E Anglian Archaeol* **86**. Chelmsford: Essex County Council, 97–101
- Cotter, J P, 2000 *Post-Roman pottery from excavations in Colchester 1971–1985*. Colchester: Colchester Archaeological Report **7**
- Cotter, J, 2009 Ceramic Building Material, in Ford, B, Sykes, D and Gruszczynski, J, Resurfacing Works, Base Court, Hampton Court Palace (SAM Surrey No. 83), Oxford Archaeology South unpublished Post-excavation Assessment Report
- Driesch, A, von den, 1976 *A guide to the measurement of animal bones from archaeological sites*, Peabody Museum Bulletin **1**
- Dunbar, E, Cook, G T, Naysmith, P, Tripney, B G, and Xu, S, 2016 AMS 14C Dating at the Scottish Universities Environmental Research Centre (SUERC) Radiocarbon Dating Laboratory, *Radiocarbon*, **58**, 9–23
- English Heritage, 2015 *Management of Research Projects in the Historic Environment: The MoRPHE Project Managers' Guide*. Swindon: Centre for Archaeology Guidelines
- Evans, C, Appleby, G and Lucy, S, 2016 *Lives in the land: Mucking excavations by Margaret and Tom Jones, 1965-1978. Prehistory: context and summary*. Cambridge Archaeological Unit Landscape Archives Series: Historiography and Fieldwork 2/Mucking 6. Oxford: Oxbow Books
- Going, C J, 1987 *The Mansio and other sites in the south-eastern sector of the Caesaromagus: the Roman pottery*. London: CBA Res Rep **62**
- Grant, A, 1982 The use of tooth wear as a guide to the age of domestic ungulates, in B. Wilson, C. Grigson and S. Payne (eds), *Ageing and sexing animal bones from archaeological sites*. Oxford: BAR Brit Ser **109**, 91–108
- Halstead, P, 1985 A study of mandibular teeth from Romano-British contexts at Maxey, in: F. Pryor, C. French, D. Crowther, D. Gurney, G. Simpson and M. Taylor (eds), *The Fenland Project: archaeology and environment in the Lower Welland Valley, volume 1*, *E Anglian Archaeol* **27**. Cambridge: Cambridgeshire Archaeological Committee, 219–24
- Hansen, S C J, 2009 Whetstones from Viking Age Iceland. As part of the Trans-Atlantic trade in basic commodities, MA Thesis, University of Iceland
- Harrison, E, 2000 Pottery and fired clay, in E. Guttmann and J. Last, A late Bronze Age landscape at South Hornchurch, Essex. *Proc Prehist Soc* **66**, 337–44
- Healey, E, 2016 The worked flint, in Evans *et al.* 2016, 52–66

- Healy, F, 1988 *The Anglo-Saxon cemetery at Spong Hill, North Elmham, part VI: occupation during the seventh to second millennia BC*, E Anglian Archaeol **39**. Norfolk: Norfolk Archaeological Unit
- Hedges, J and Buckley, D G, 1978 Excavations at a Neolithic causewayed enclosure, Orsett, Essex, 1975. *Proc Prehist Soc* **44**, 219–308
- Highways England, 2018 Lower Thames Crossing: A Scheme Wide Specification for Archaeological Trial Trenching: unpublished document HE540039-CJV-GEN-GEN-SPE-HER-00001draft, Revision 1.05
- Inizan, M-L, Reduron-Ballinger, M, Roche, H and Tixier, J, 1999 *Technology and terminology of knapped stone*. Nanterre: Cercle de Recherches et d'Etudes Préhistoriques, CNRS
- Jefferies, R and Lucy, S, 2016 Romano-British pottery, in S. Lucy and C. Evans, *Romano-British settlement and cemeteries at Mucking: excavations by Margaret and Tom Jones, 1965–1978*. Cambridge Archaeological Unit Landscape Archives Series: Historiography and Fieldwork 3/Mucking 5. Oxford: Oxbow Books, 154–99
- Mays, S, 1998 *The archaeology of human bones*, London, Routledge
- McKinley, J I, 2000 Cremation burials, in B. Barber and D. Bowsher, *The eastern cemetery of Roman London. Excavations 1983-1990*, MoLAS Monogr **4**, 264–77
- McKinley, J I, 2004 Compiling a skeletal inventory: cremated human bone, in M. Brickley and J. I. McKinley (eds), *Guidelines to the standards for recording human remains*, IFA Paper No. **7**, BABAO and IFA, Southampton and Reading, 9–13
- McKinley, J I, 2006 Cremation...the cheap option?, in C. Knusel and R. Gowland (eds) *The social archaeology of funerary remains*, Oxford, Oxbow Books, 81-8
- McKinley, J I, 2013 Cremation: excavation and analysis, in S. Tarlow and L. Nilsson Stutz (eds) *The Oxford Handbook of the archaeology of death and burial*, Oxford, Oxford University Press, 147–72
- Medlycott, M (ed.), 2011 *Research and archaeology revisited: a revised framework for the East of England*, E Anglian Archaeol Occas Paper **24**. Association of Local Government Archaeological Officers
- MOLA, 2014 *London medieval and post-medieval pottery codes*. Museum of London Archaeology. <http://www.mola.org.uk/medieval-and-post-medieval-pottery-codes> (accessed 11 Jan 2019)
- Oxford Archaeology, 2019a Lower Thames Crossing scheme-wide written scheme of investigation for trial trenching south of the River Thames
- Oxford Archaeology, 2019b Lower Thames Crossing scheme-wide written scheme of investigation for trial trenching north of the River Thames

- Oxford Archaeology, 2020 Lower Thames Crossing detailed written scheme of investigation for trial trenching of Land Parcels 3 (north), 30–35 and 103–107
- Oxford Cotswold Archaeology, 2020 Lower Thames Crossing archaeological evaluation report for trial trenching of Land Parcel 3, Hornsby Lane, Orsett Heath, Essex
- Palmer, J J, 2019 Open Domesday. <https://opendomesday.org/place/>: University of Hull
- PCRG, SGRP, MPRG, 2016 *A standard for pottery studies in archaeology*, Prehistoric Ceramics Research Group, Study Group for Roman Pottery and Medieval Pottery Research Group
- Place Services, 2019 Lower Thames Crossing aerial investigation and mapping report, Essex County Council
- Reimer, P, Austin, W, Bard, E, Bayliss, A, Blackwell, P, Bronk Ramsey, C, *et al* 2020 The IntCal20 Northern Hemisphere radiocarbon age calibration curve (0–55 cal kBP), *Radiocarbon*, 62
- Scott, E M, Cook G, and Naysmith, P, 2010 The fifth international radiocarbon intercomparison (VIRI): an assessment of laboratory performance in stage 3, *Radiocarbon*, 53, 859–65
- Serjeantson, D, 1996 Animal bone, in S. Needham and T. Spence (eds), *Runnymede Bridge research excavations, volume 2: refuse and disposal at Area 16 East, Runnymede*. London: British Museum Press, 194–223
- Scheuer, L and Black, S, 2000 *Developmental Juvenile Osteology*. Oxford, Elsevier Academic Press
- Silver, I A, 1969 The ageing of domestic animals, in *Science in Archaeology* (eds D R Brothwell and E S Higgs), 283–302, London
- Sjøvold, T, 1987 Decorated skulls from Hallstatt, Austria: the development of a research project, in G Burenhult, A Carlsson, A Hyenstrand and T Sjøvold (eds) *Theoretical approaches to artifacts, settlement and society*, BAR Int Ser **366**, Oxford, 5–21
- Stace, C, 1997 *New Flora of the British Isles*. Cambridge, Cambridge University Press Books
- Stuiver, M and Polach, H A, 1977 Reporting of <sup>14</sup>C data, *Radiocarbon* **19**, 355–363
- Stuiver, M and Kra, R S, 1986 Editorial comment, *Radiocarbon*, **28**
- Subterranea Britannica, 2019 <https://www.subbrit.org.uk/orsett-roc-post/>
- Tomber, R and Dore, J, 1998 *The national Roman fabric reference collection: a handbook*. London: MOLAS Monogr **2**
- Torgersen, J H, 1951a. The developmental genetics and evolutionary meaning of the metopic suture, *American J Physical Anthropol* **9**, 193–205

- Torgersen, J H, 1951b Hereditary factors in the sutural patterns of the skull, *Acta Radiologica* **36**, 374–82
- Torgersen, J H, 1954 The occiput, the posterior cranial fossa and the cerebellar anatomy, in J. Jansen and A. Brodal (eds), *Aspects of cerebellar anatomy*, Gundersen, Oslo, 396–418
- Tyrrell, A, 2000 Skeletal assessment of non-metric traits and the assessment of inter- and intra-population diversity: past problems and future potential, in M Cox and S Mays (eds) *Human osteology in archaeology and forensic science*, Greenwich Medical Media, London, 289–306
- Wilkinson, T J, 1988 Archaeology and Environment in South Essex: Rescue Archaeology on the route of the A13 Grays By-pass, 1979/80. *East Anglian Archaeology* 42
- Zohary, D, Hopf, M and Weiss, E, 2012 *Domestication of Plants in the Old World: the origin and spread of cultivated plants in West Asia, Europe, and the Nile Valley*, 4th edition, Oxford, Clarendon Press

## Appendix E      Abbreviations and Glossary

---

**ADS** Archaeology Data Service. Digital archaeological archive

**CDM** Construction Design Manual. Health and safety guidance for the construction industry

**CPD** Continuing Professional Development

**CIfA** Chartered Institute for Archaeologists

**DBA** Desk Based Assessment. Detailed assessment of archaeology and other aspects of the historic environment

**DCO** Development Consent Order

**EIA** Environmental Impact Assessment. Detailed study of environmental impacts as directed under the Town and Country Planning (Environmental Impact Assessment) Regulations 2017 following on from EU Directive EIA Directive (85/337/EEC)

**ES** Environmental Statement. The principal environmental report detailing environmental impacts within an EIA

**GPS** Global Positioning System

**HER** Historic Environment Record

**LTC** Lower Thames Crossing

**MCIfA** Member of the Chartered Institute for Archaeologists

**MoRPHE** Management of Research Projects in the Historic Environment

**NMP** National Mapping Programme. A study of aerial photographs and digitisation of resulting data into GIS. Originally funded by Historic England

**OASIS** Online Access to the Index of archaeological investigations.  
The OASIS project brings together a number of strategic partners: the Archaeology Data Service, Historic England, Historic Environment Scotland, and the Royal Commission on the Ancient and Historical Monuments of Wales under the umbrella of the University of York

**OCN** Old County Number. Historic England's reference for material that is not readily-available online and may represent historic archaeological work that consists of paper archives or has yet to be formally reported on

**PINS** Planning Inspectorate

**RAMS** Risk Assessment Method Statement

**SMC** Scheduled monument consent

**TDR** Trusted Digital Repository

**UKIC** United Kingdom Institute for Conservation

**WSI** Written Project of Investigation. A detailed method statement for archaeological work

**WSL** – Western Southern Link  
The Western Southern Link (WSL) is an alternative for Short List Routes 2, 3 and 4 to the south of the River Thames.



## Appendix F Site Summary

---

|                           |  |
|---------------------------|--|
| <b>Site name:</b>         | Lower Thames Crossing Archaeological Evaluation Report for Trial Trenching of Land Parcels 3 (North), 30 and 35, Land Bordering the A13 at Orsett, Essex |
| <b>Site code:</b>         | LTC6T20  |
| <b>Grid Reference</b>     | NGR 564149, 180821   |
| <b>Type:</b>              | Evaluation   |
| <b>Date and duration:</b> | 28th September to 27th October 2020, and 17th May to 22nd July 2021  |
| <b>Area of Site</b>       | Approximately 47ha   |

### Location of archive:

The archive from LTC3020 (Land Parcels 3, 30 and 35) will form part of the overall trial trenching scheme archive. This will be deposited in a repository consistent with the standards required by the Museums and Galleries Commission following completion of the archaeological phase of this project. This may either be with the local receiving museum in Thurrock or, if no such repositories are available, with a repository for the whole project designated by LTC. LTC retain the overall responsibility for the successful deposition of the project archive.

Currently, the archive is held at Oxford Archaeology's head office, Janus House, Osney Mead, Oxford, Oxfordshire, OX2 0ES. Oxford Archaeology will store the archive for LTC for a maximum period of two years following the completion of the project. If the storage of the archive at OA's office extends past this period, an extension to the storage period and final deposition timetable will be reviewed by OA and LTC and agreed with the major stakeholders.

### Summary of Results:

Oxford Cotswold Archaeology was commissioned by Balfour Beatty to undertake a trial trench evaluation of Land Parcels 3 (North), 30, 31, 32, 34, 35, 103, 104 and 107 covered by WSI G of the Lower Thames Crossing Pre-Enabling Works. These Land Parcels are located either side of the A13, and to the south and east of Orsett within the county of Essex and Thurrock unitary authority (NGR 564149, 180821). A total of 167 trenches were excavated and recorded between 28th September and 27th October 2020 across Land Parcels 3, 30 and 35. A further 100 trenches were excavated in Land Parcels 31, 103, 104 and 107 between 17th May 2021 and 22nd July 2021, making a combined total of 267 trenches, over half of which contained archaeological features.

The evaluation revealed a range of archaeological activity dating from the early Neolithic (and possibly Mesolithic) onwards. A single pit containing early Neolithic pottery and flint was recorded in the north-east corner of Land Parcel 30 and residual artefacts of the same date were also recovered from the same area. Worked flint from Land Parcel 107 hint at the existence of earlier prehistoric flint scatters on the edge of the Mar Dyke valley in the north-western part of the site. Evidence of a ring ditch corresponding to a circular cropmark, although very heavily truncated, was found, and this may also be of earlier prehistoric date.

A group of 3 unaccompanied cremations, of which one was radiocarbon-dated to the transition from the early-middle Bronze Age, perhaps indicates a small cemetery group in

the west of Land Parcel 3 (North). Otherwise, the evaluation revealed scattered evidence for Bronze Age and Iron Age activity across Land Parcels 3, 30 and 107. There was a slight concentration of evidence in Land Parcel 30, where a low density of ditches and discrete features with small quantities of finds provided an indication of dispersed settlement and associated later prehistoric field systems. However, the limited size of the pottery assemblage and lack of diagnostic pieces has made it difficult to determine the periods of activity more precisely.

Rectilinear cropmarks indicating ditched enclosures in Land Parcel 3 north were confirmed to be Roman in date. Occupation spanned the early to middle Roman periods (mid-1st to later 3rd century AD), apparently peaking in the 2nd and 3rd centuries. There was little evidence that activity continued into the 4th century. Evidence from Trenches 135 to 150 revealed that the activity was well-defined within the ditched enclosures, and concentrations of pits and postholes with associated finds assemblages clearly demonstrate domestic settlement. Evidence for industrial activities is limited, but trial trenching from Hornsby Lane to the south and east has shown that these enclosures were linked to both pottery production and agricultural economies. The rectilinear system of cropmarks to the north of the A13 are likely to be of Roman date and also suggest a focus on an agricultural economy, but due to their peripheral location very few of these features provided reliable dating evidence.

Archaeological evidence dating after the Roman period was overall sparse, but notable features in Land Parcel 30 included an isolated pit of early/middle Anglo-Saxon date in Trench 76 and a medieval pit with a large assemblage of pottery in Trench 104 at the south-east corner. Two trenches in Land Parcel 104 contained features with medieval pottery, quern fragments and iron slag from both smelting and smithing. During the post-medieval period, the site was almost entirely used for agricultural activity.

A large number of undated features was found across most of the land parcels, and indicate that the density of activity of any of the periods mentioned above may well increase when more of these features are exposed and further dating evidence becomes available.

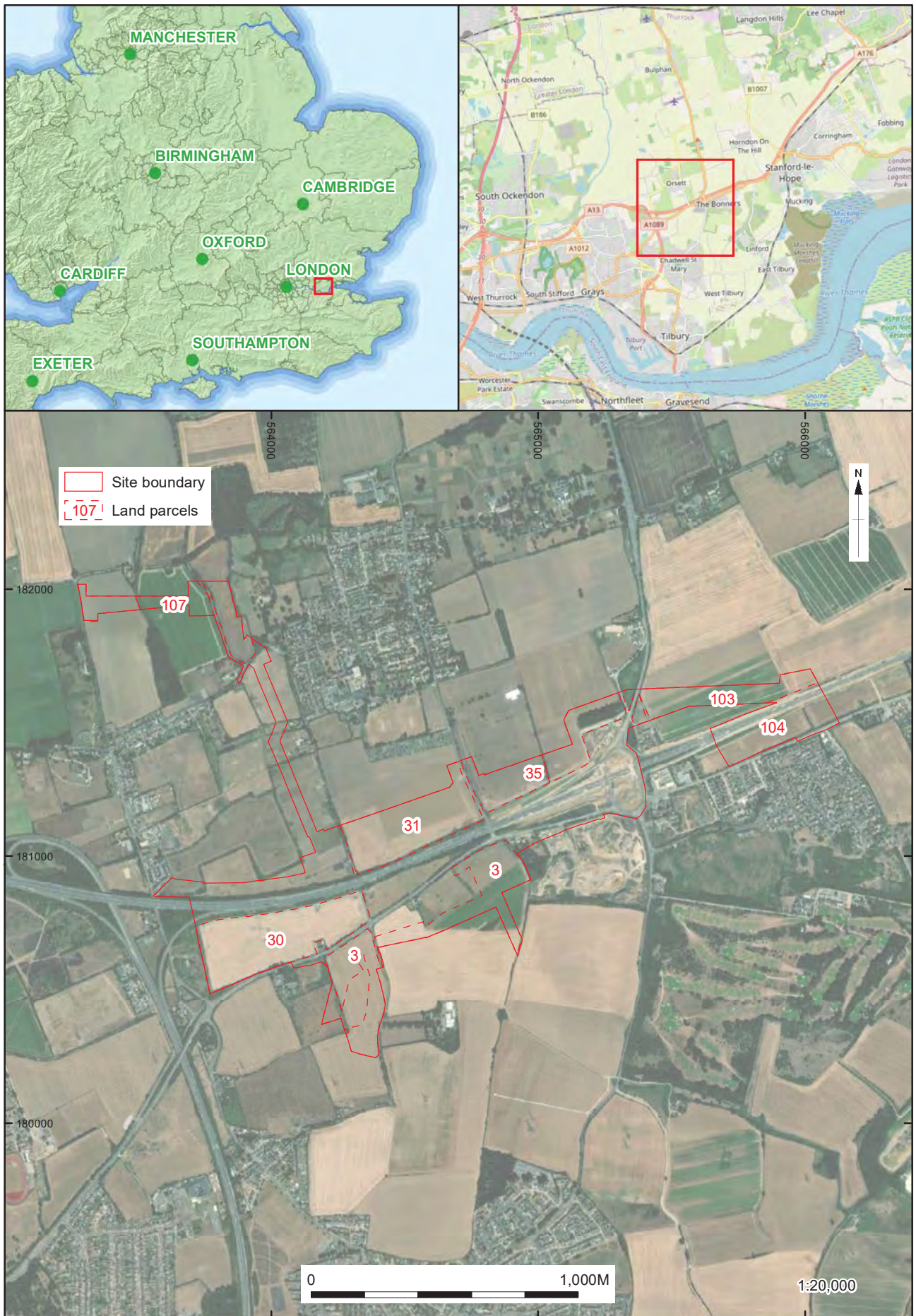

X:\ILTCEV\_Lower\_Thames\_Crossing\010Geomatics\03 GIS Projects - LTC3020\Figures\LTC3020\_Figure\_1\_(2021).mxd\benjamin.brown\29/09/2021

Figure 1: Site location

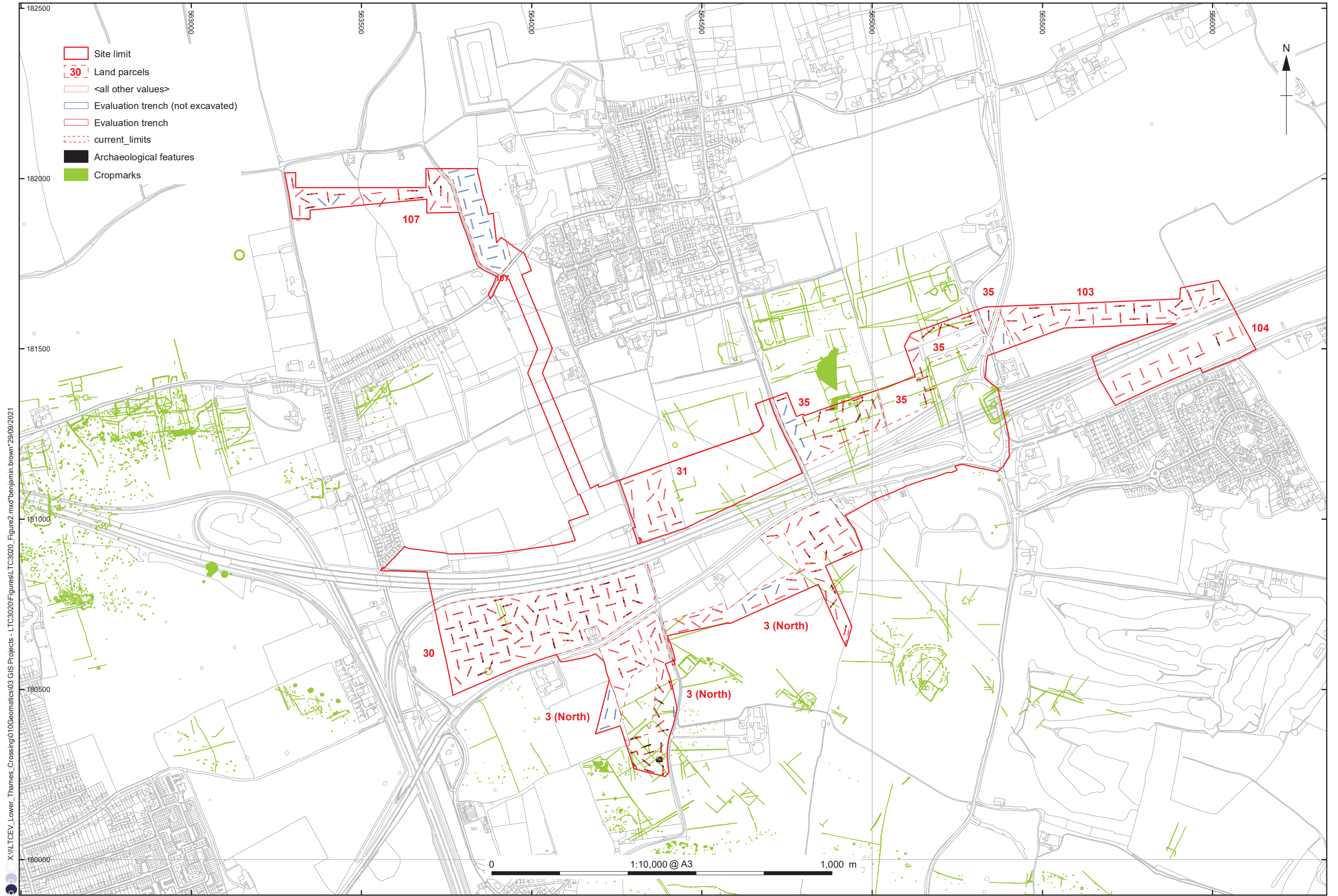

X:\ILTCEV\_Lower\_Thames\_Crossing\010Geomatics\03 GIS Projects - LTC3020\Figures\TC3020\_Figure2.mxd\benjamin.brown\29/09/2021

Contains Ordnance Survey data © Crown copyright and database right 2020, provided by client

Figure 2: Trench layout and cropmark features, Land Parcels 3 (North), 30, 31, 35, 103, 104 and 107

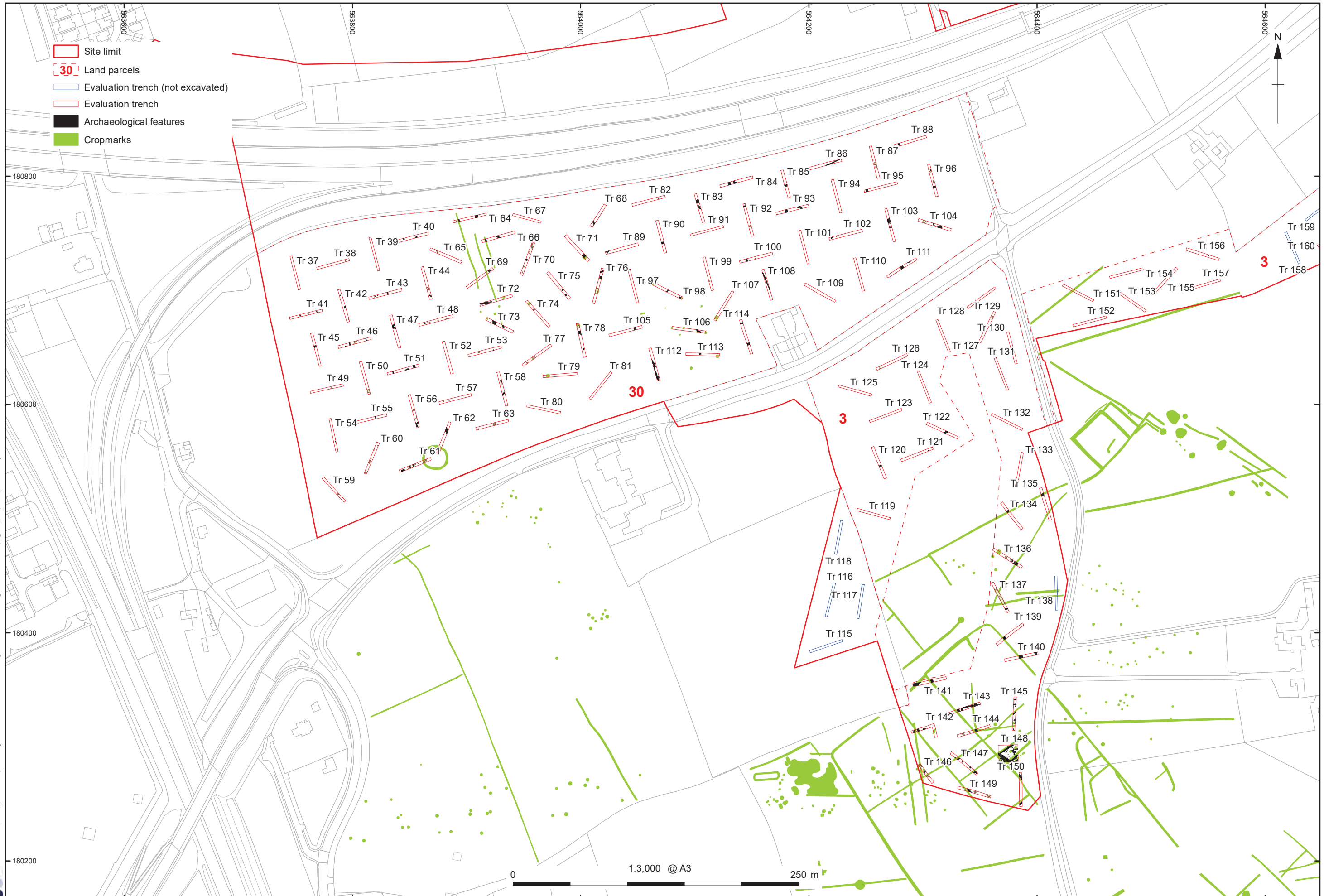

X:\ILTCEV\_Lower\_Thames\_Crossing\010Geomatics\03 GIS Projects - LTC3020\Figures\TC3020\_Figure\_3\_(2021).mxd\*benjamin.brown\*29/09/2021

Contains Ordnance Survey data © Crown copyright and database right 2020, provided by client

Figure 3: Trench layout showing archaeological features and cropmarks, Land Parcel 3 (North) and 30

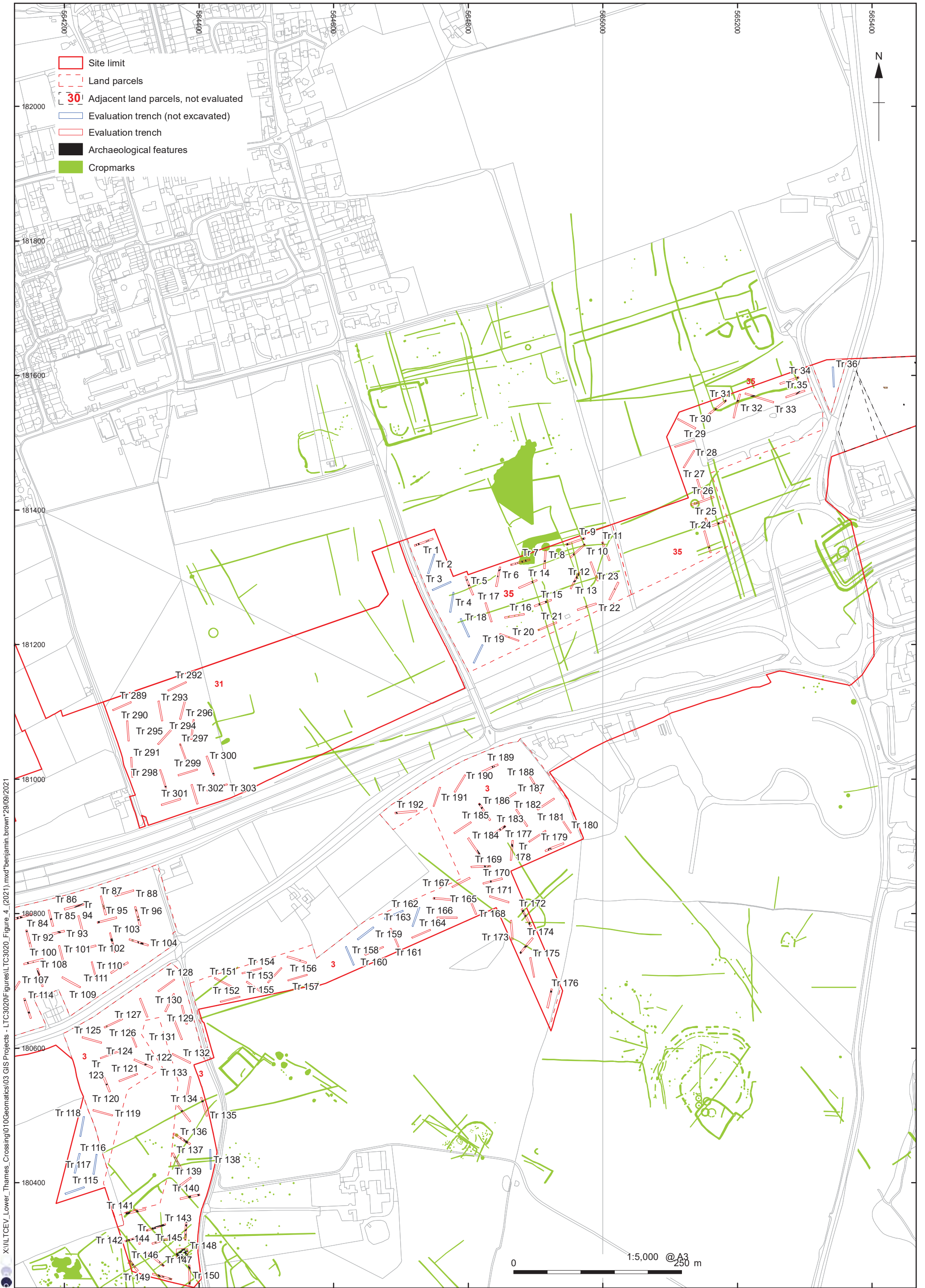

X:\ILTCEV\_Lower\_Thames\_Crossing\010\Geomatics\03 GIS Projects - LTC3020\Figures\TC3020\_Figure\_4\_(2021).mxd\benjamin.brown\*29/09/2021

Contains Ordnance Survey data © Crown copyright and database right 2020.

Figure 4: Trench layout showing archaeological features and cropmarks, Land Parcel 3 (North), 31 and 35

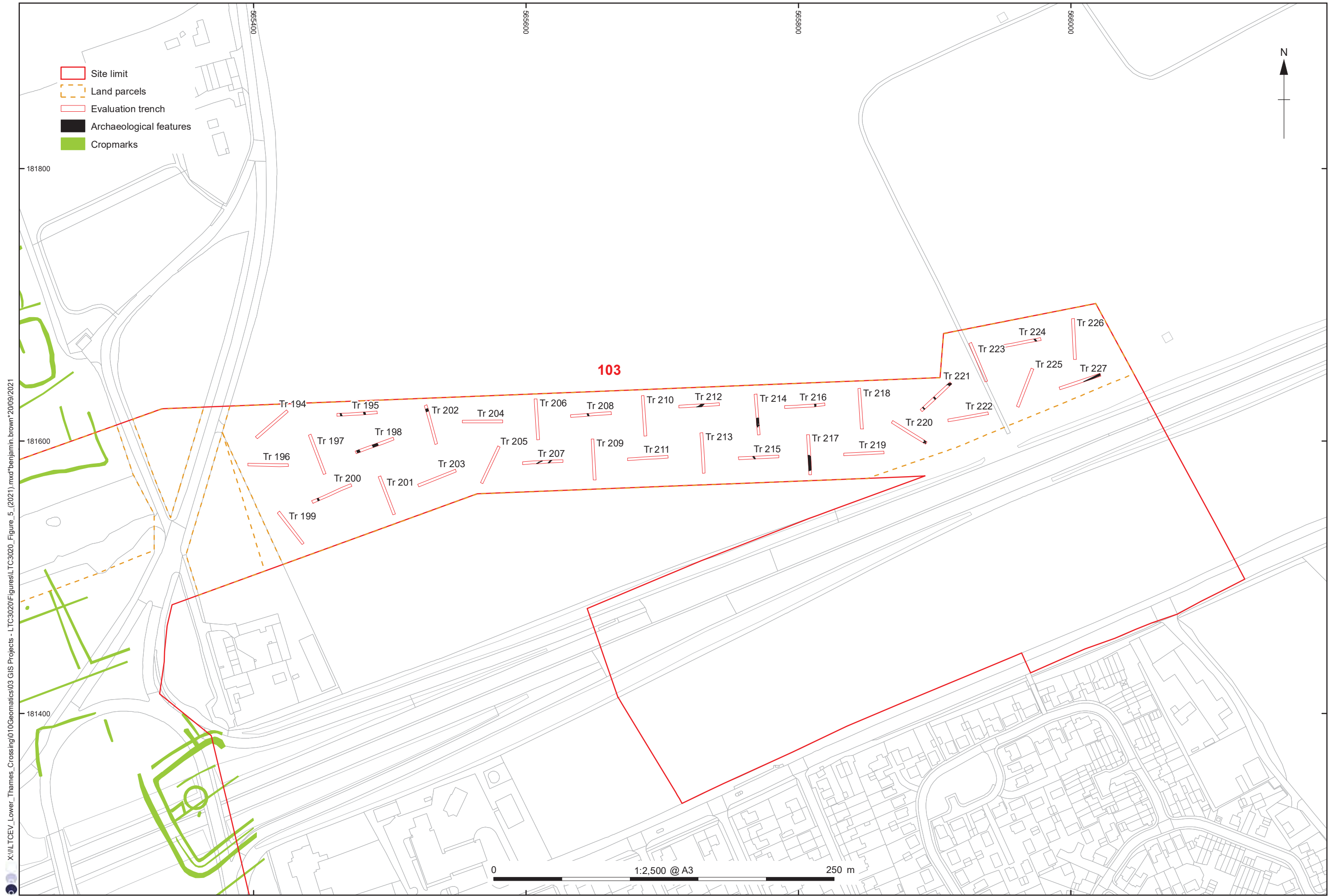

X:\ILTCEV\_Lower\_Thames\_Crossing\010\Geomatics\03 GIS Projects - LTC3020\Figures\LTC3020\_Figure\_5\_(2021).mxd\*benjamin.brown\*20/09/2021

Contains Ordnance Survey data © Crown copyright and database right 2020, provided by client

Figure 5: Trench layout showing archaeological features and cropmarks, Land Parcel 103

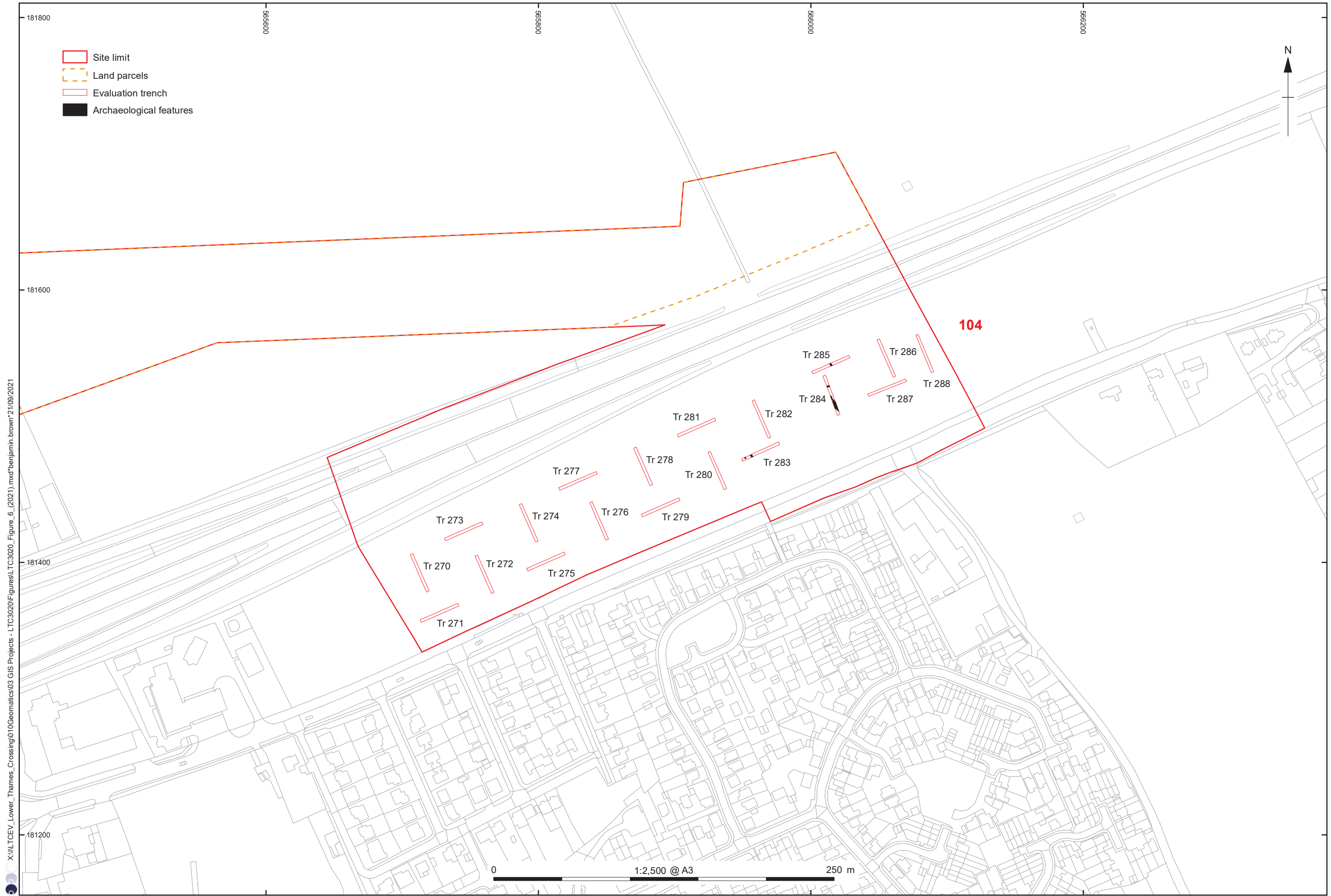
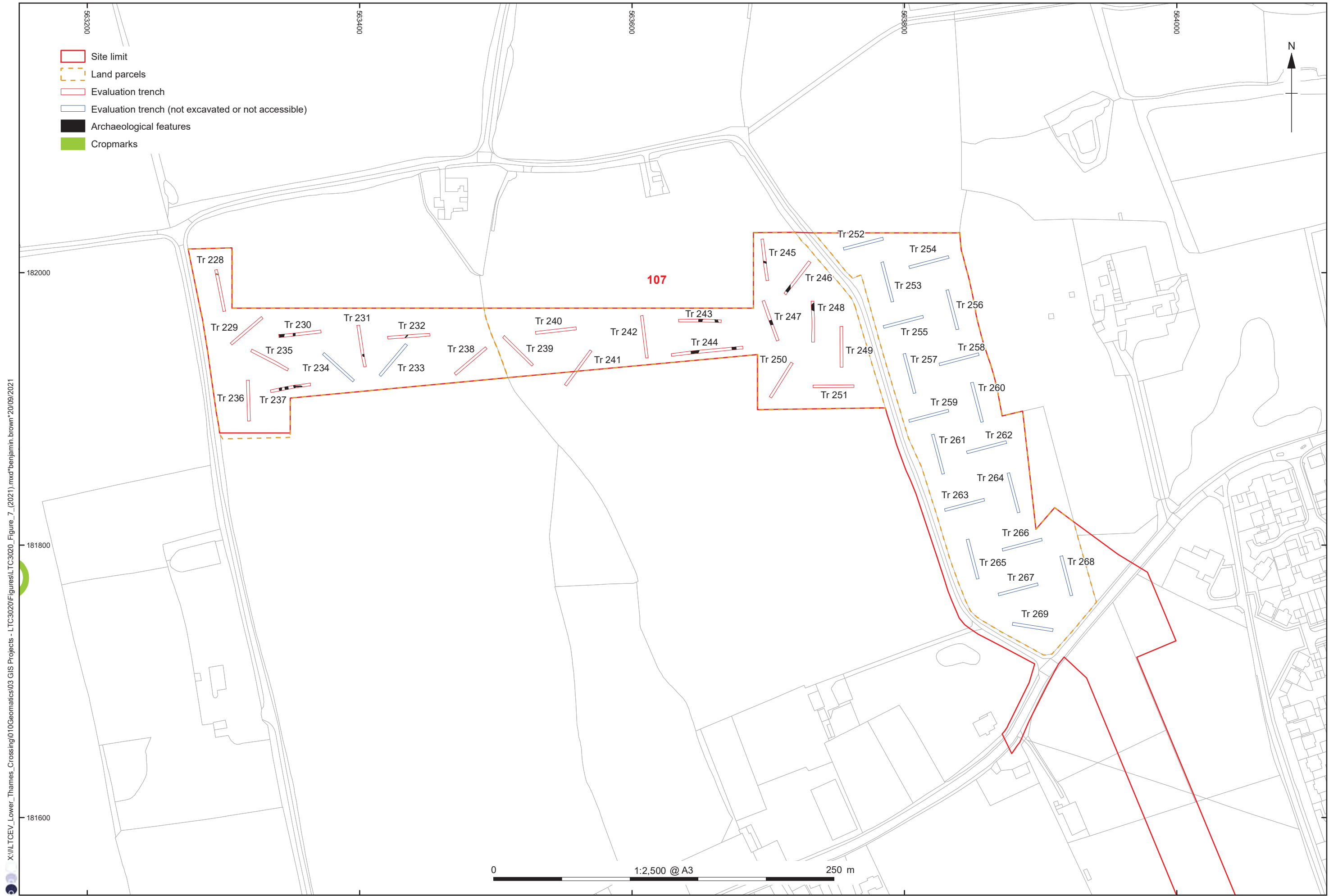

Figure 6: Trench layout showing archaeological features and cropmarks, Land Parcel 104





X:\ILTCEV\_Lower\_Thames\_Crossing\010\Geomatics\03 GIS Projects - LTC3020\Figures\TC3020\_Figure\_7\_(2021).mxd\*benjamin.brown\*20/09/2021

Contains Ordnance Survey data © Crown copyright and database right 2020, provided by client

Figure 7: Trench layout showing archaeological features and cropmarks, Land Parcel 107

X:\ILTCEV\_Lower\_Thames\_Crossing\010Geomatics\03 GIS Projects - LTC3020\Figures\TC3020\_Figure\_8\_(2021).mxd\*benjamin.brown\*21/09/2021

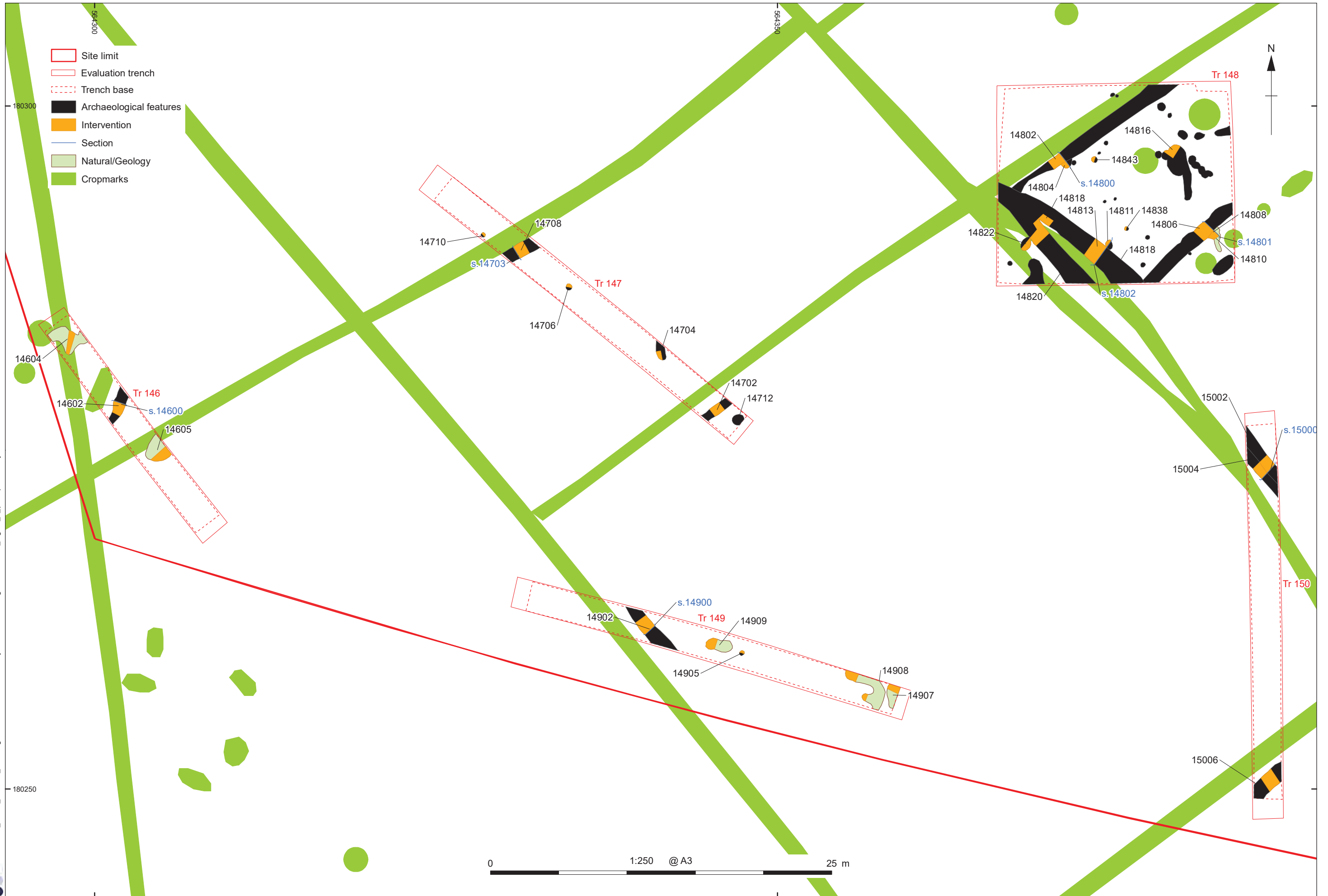

Contains Ordnance Survey data © Crown copyright and database right 2020, provided by client

Figure 8: Detailed plan of Trenches 146-50

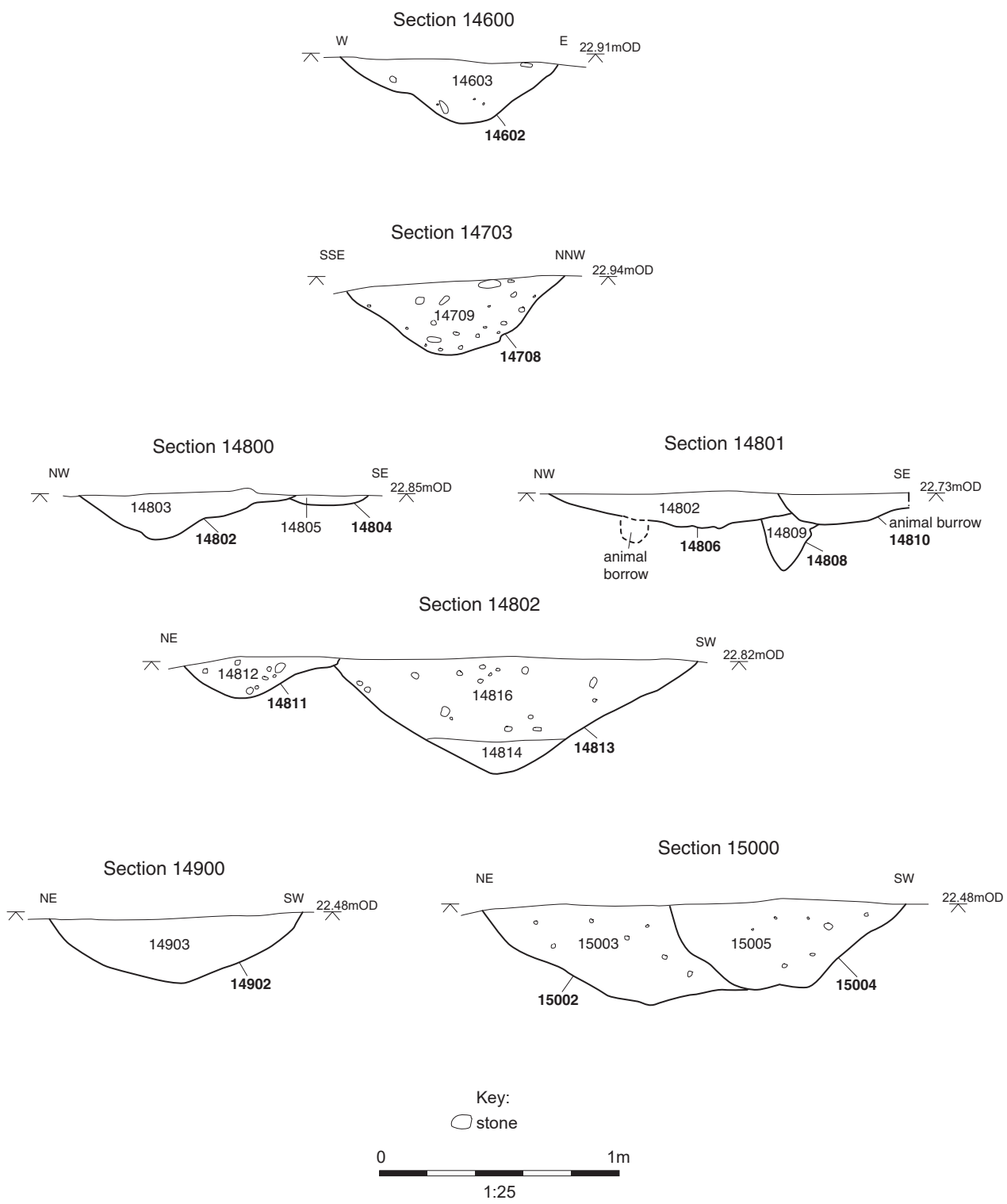
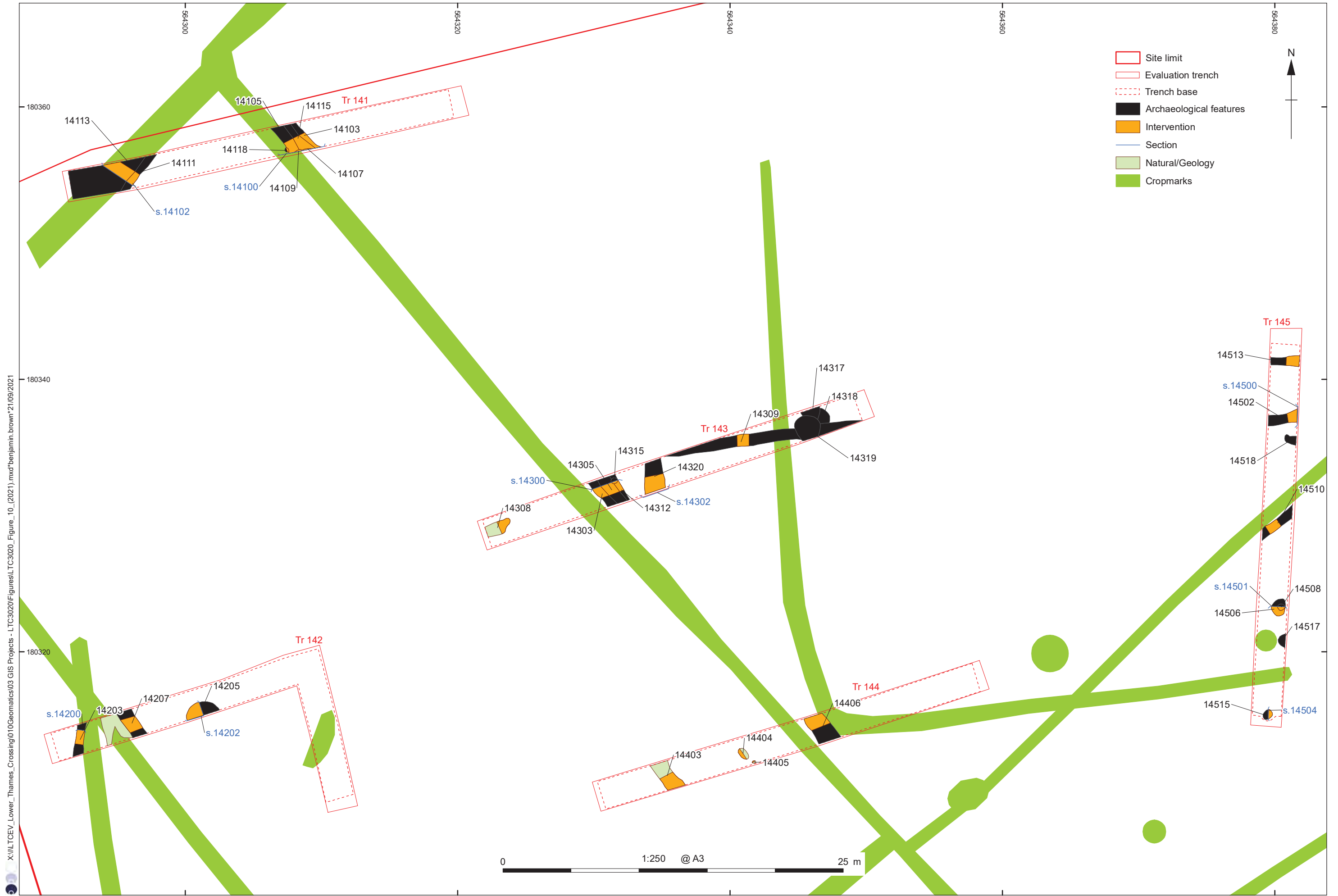

Figure 9: Sections, Trenches 146 – 50



X:\ILTCEV\_Lower\_Thames\_Crossing\010Geomatics\03 GIS Projects - LTC3020\Figures\LTC3020\_Figure\_10\_(2021).mxd\benjamin.brown\*21/09/2021

Contains Ordnance Survey data © Crown copyright and database right 2020, provided by client

Figure 10: Detailed plan of Trenches 141-5

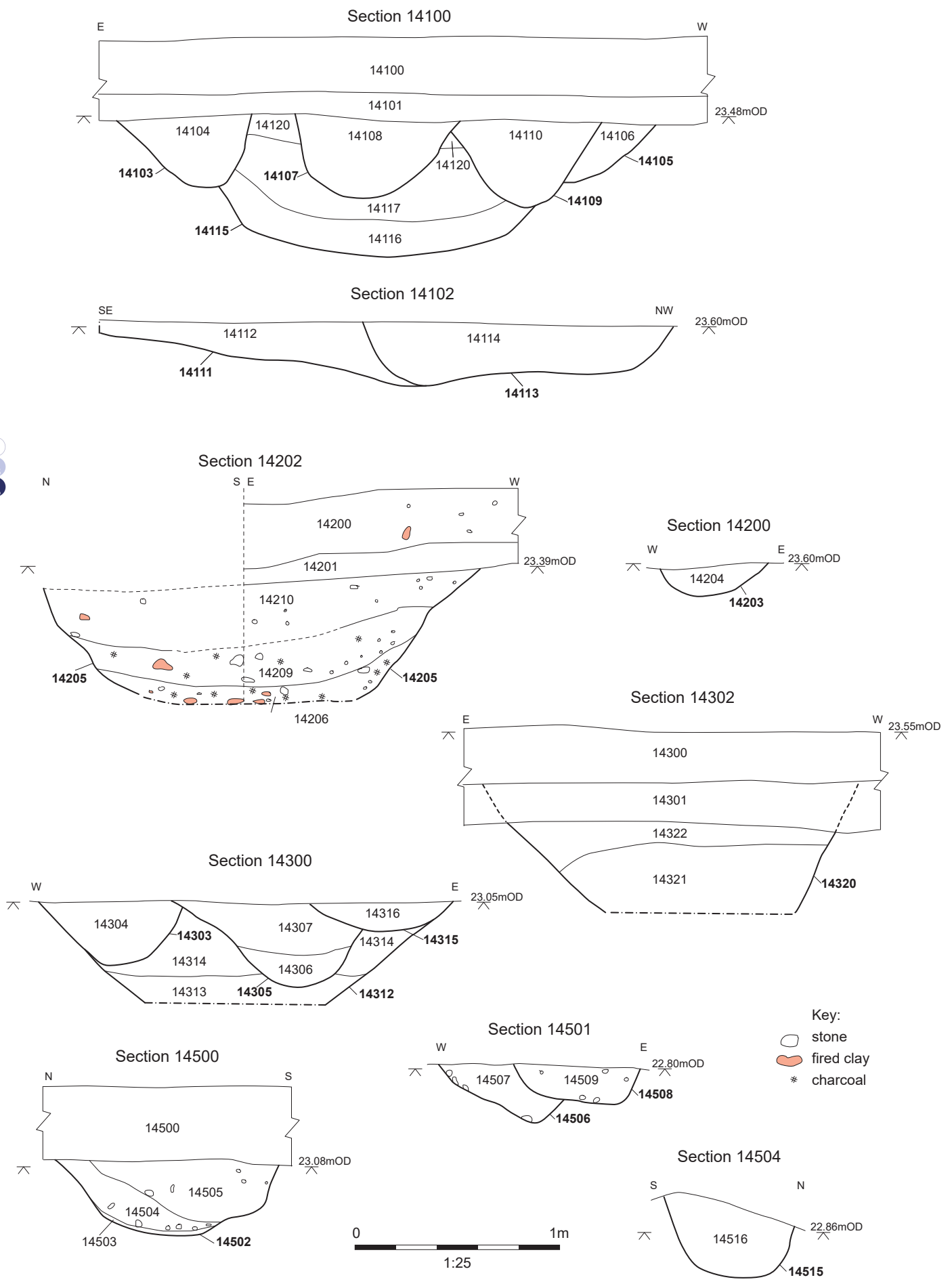
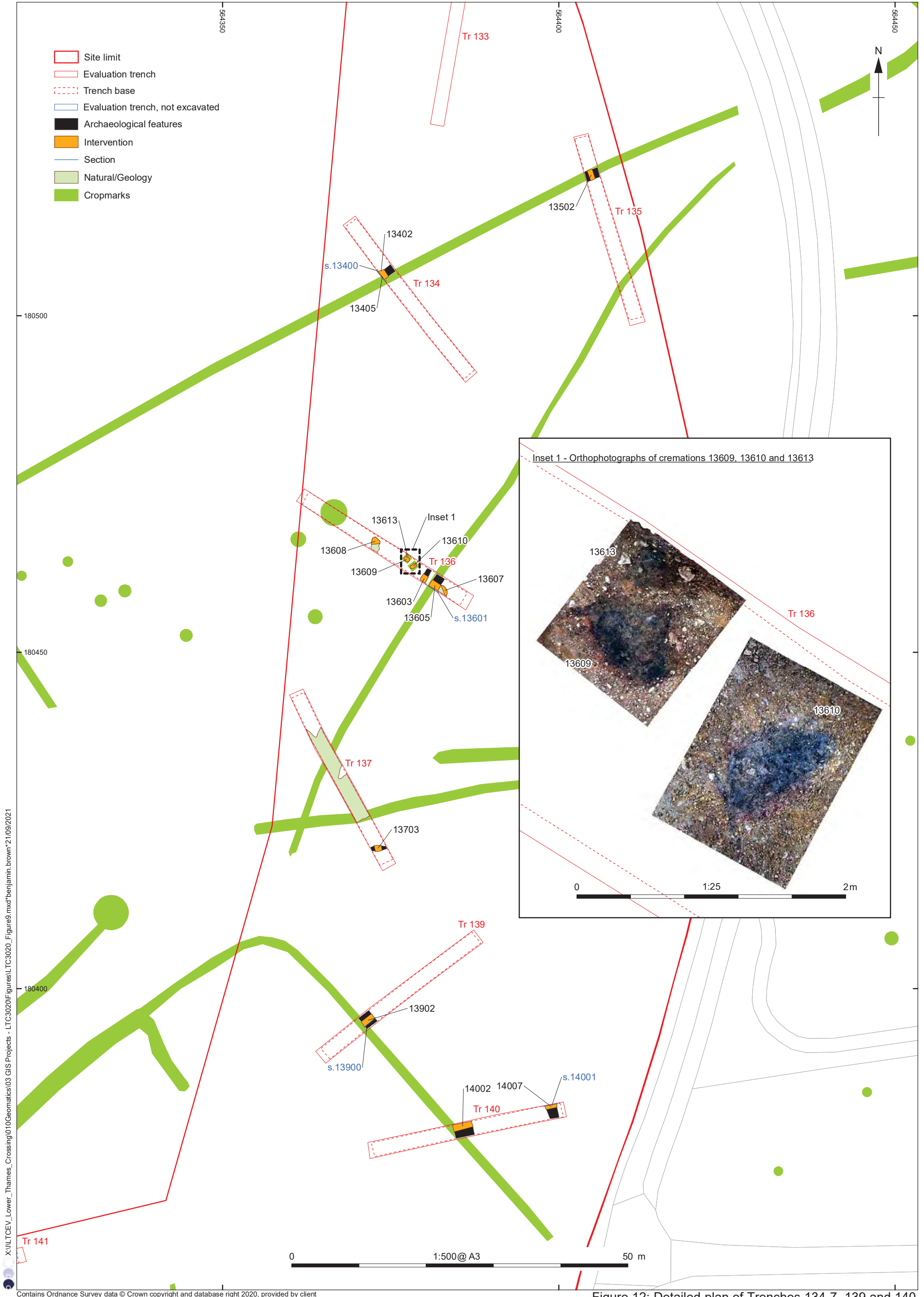

Figure 11: Sections, Trenches 141-3 and 145



X:\ILTCEV\_Lower\_Thames\_Crossing\010\Geomatics\03 GIS Projects - LTC3020\Figures\TC3020\_Figures9.mxd\*benjamin.brown\*21/09/2021

Contains Ordnance Survey data © Crown copyright and database right 2020, provided by client

Figure 12: Detailed plan of Trenches 134-7, 139 and 140

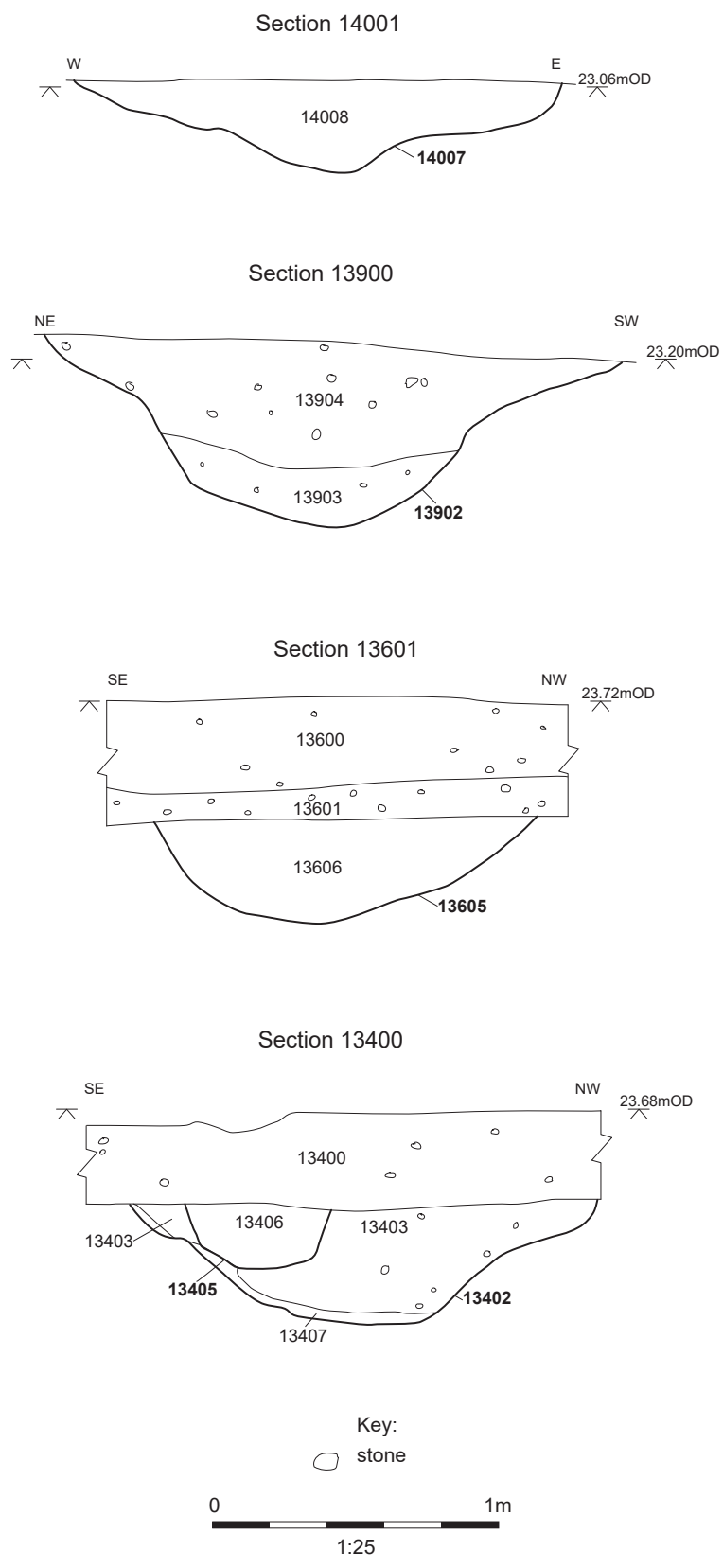

Figure 13: Sections, Trenches 134, 136, 139 and 140

X:\ILTCEV\_Lower\_Thames\_Crossing\010Geomatics\03 GIS Projects - LTC3020\Figures\TC3020\_Figure\_14\_(2021).mxd\benjamin.brown\21/09/2021

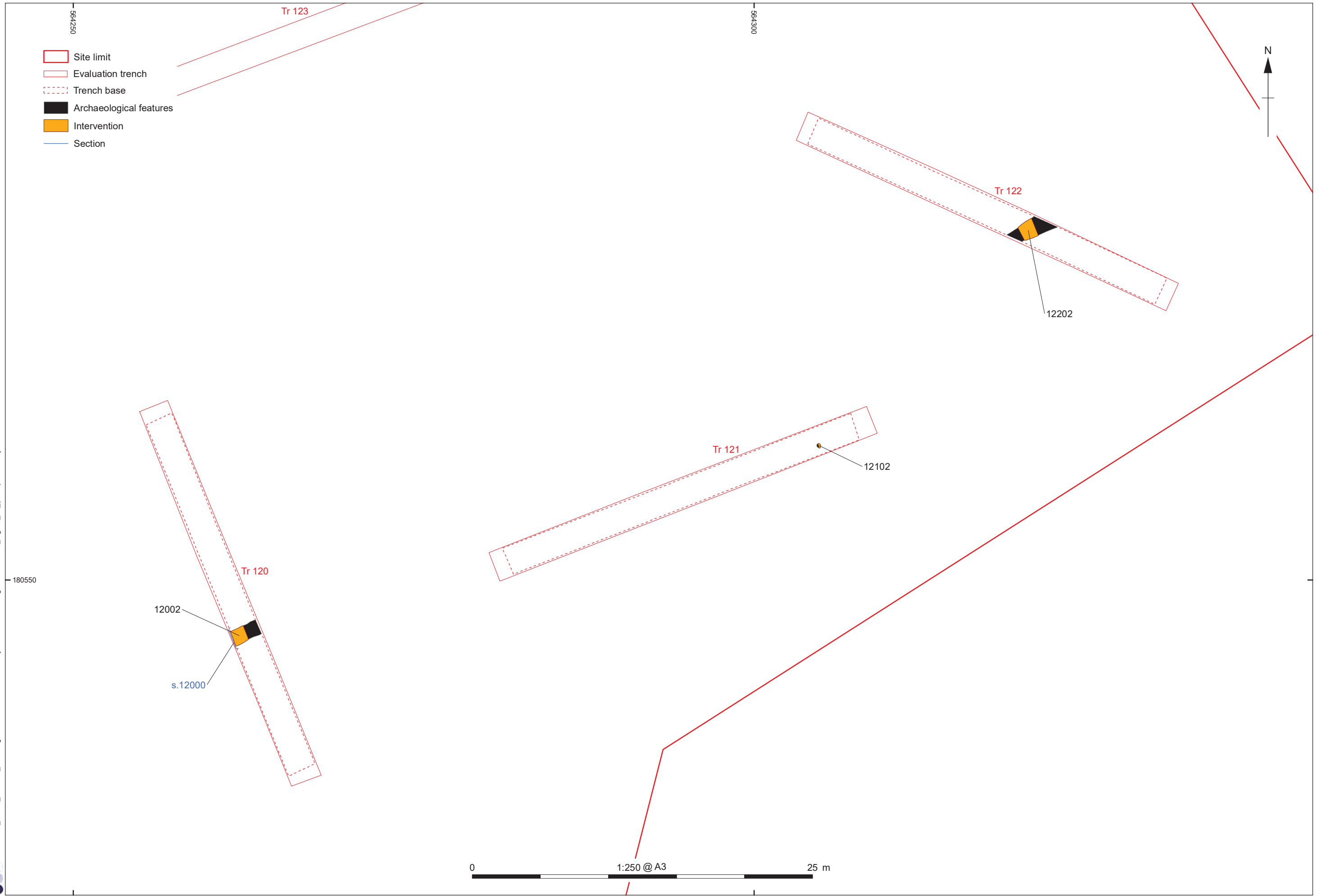
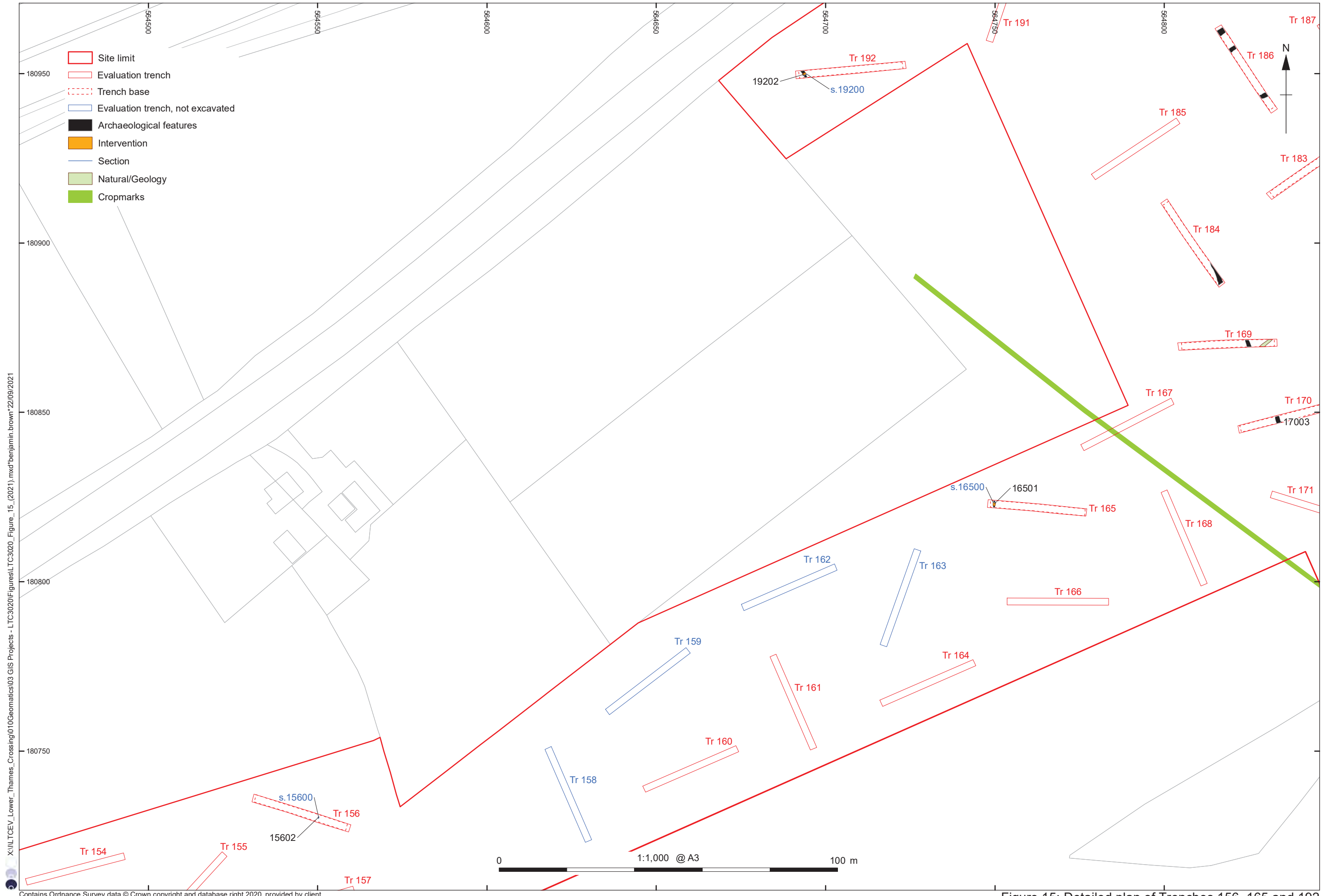

Figure 14: Detailed plan of Trenches 120-2





X:\ILTCEV\_Lower\_Thames\_Crossing\010Geomatics\03 GIS Projects - LTC3020\Figures\TC3020\_Figure\_15\_(2021).mxd\benjamin.brown\*22/09/2021

Contains Ordnance Survey data © Crown copyright and database right 2020, provided by client

Figure 15: Detailed plan of Trenches 156, 165 and 192

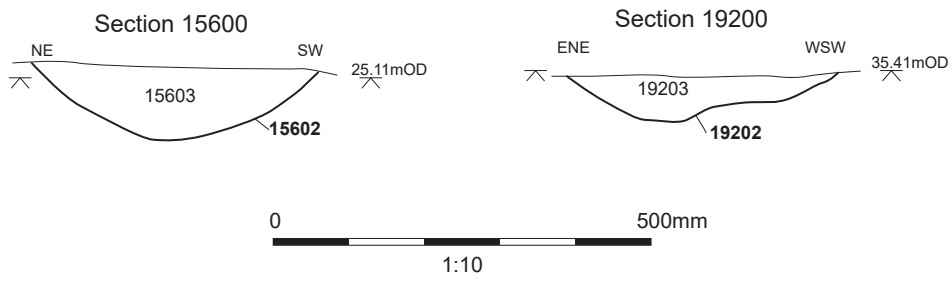
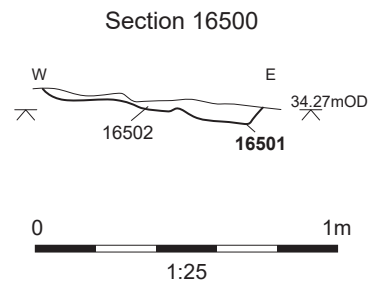
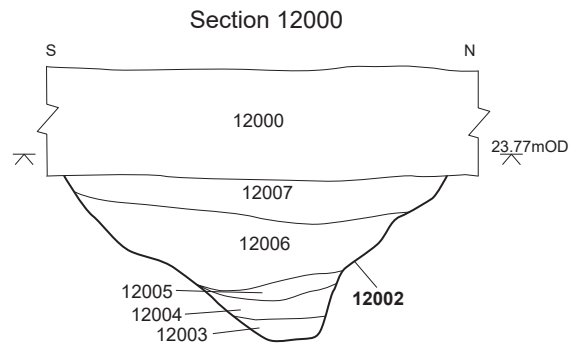
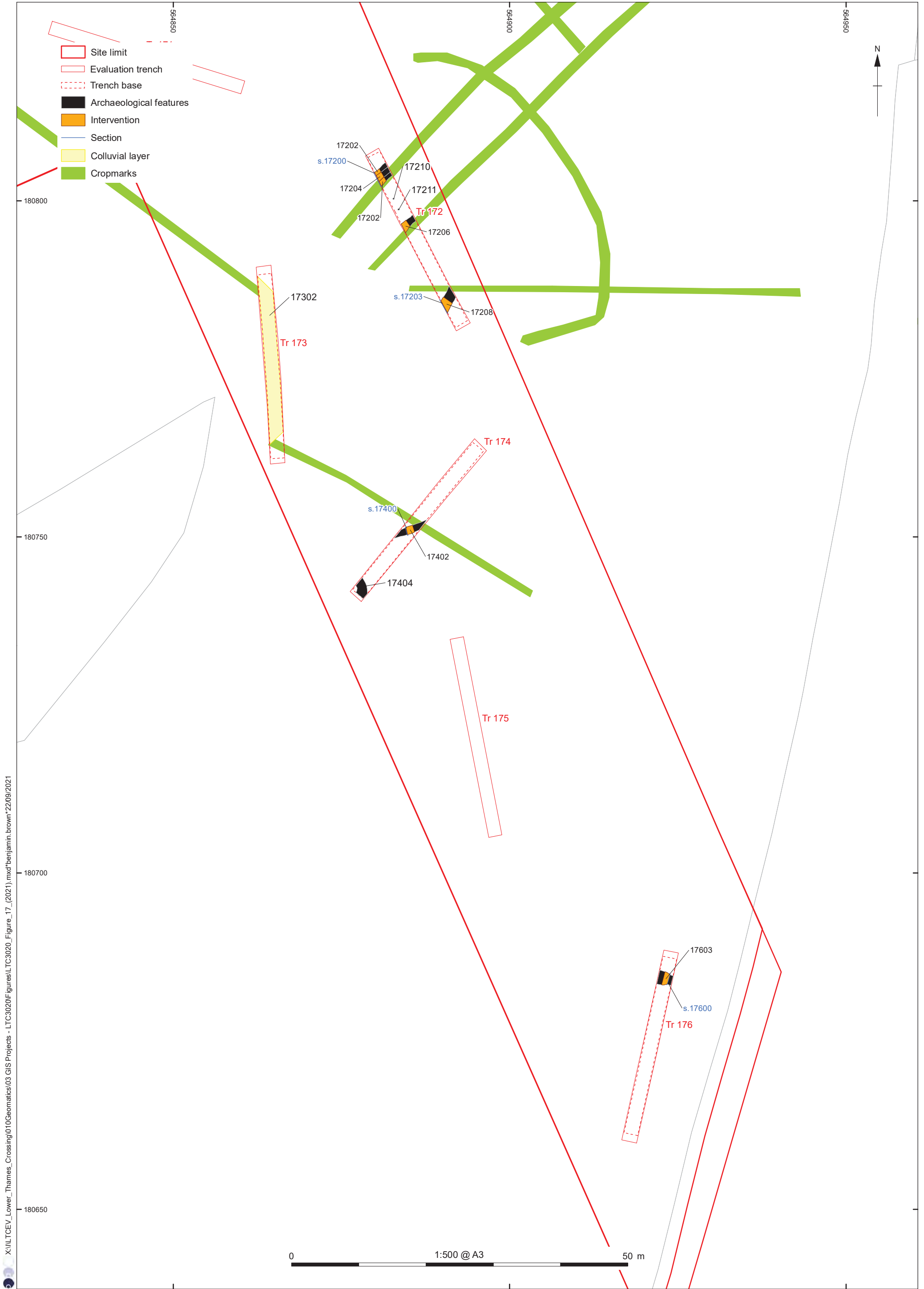

Figure 16: Sections, Trenches 120, 156, 165 and 192



X:\ILTCEV\_Lower\_Thames\_Crossing\010\Geomatics\03 GIS Projects - LTC3020\Figures\TC3020\_Figure\_17\_(2021).mxd\*benjamin.brown\*22/09/2021

Contains Ordnance Survey data © Crown copyright and database right 2020, provided by client

Figure 17: Detailed plan of Trenches 172-4 and 176

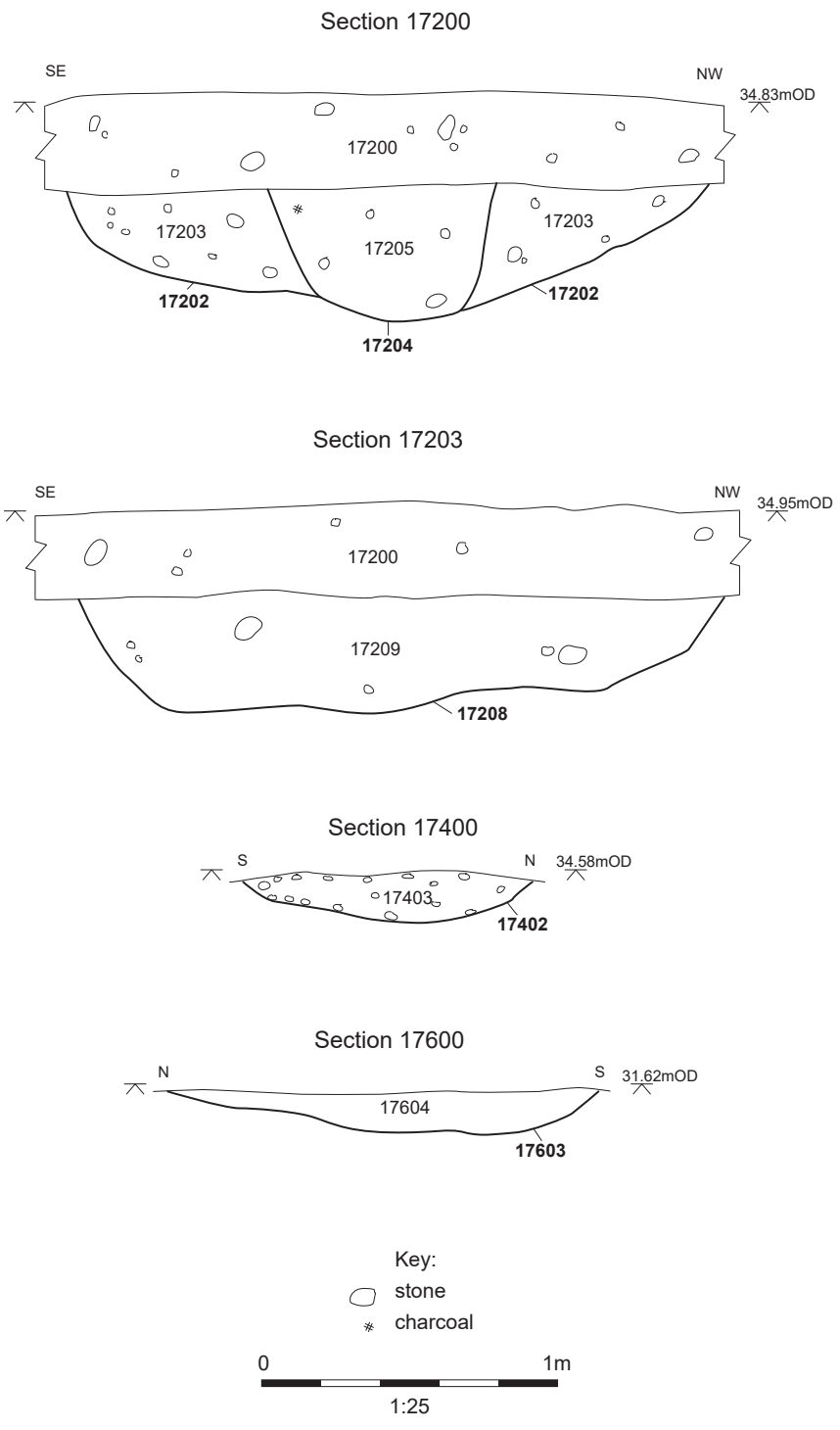
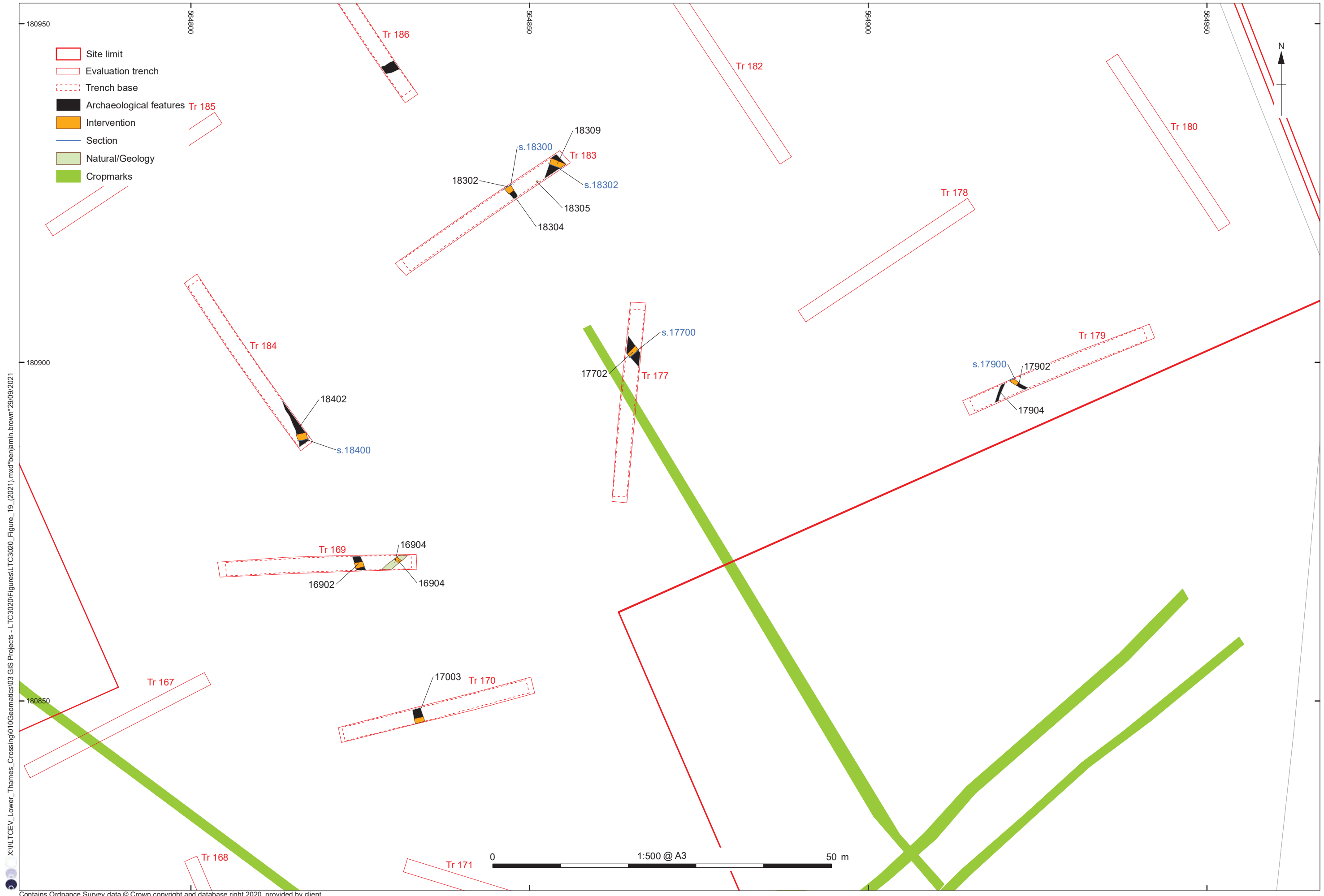

Figure 18: Sections, Trenches 172, 174 and 176



X:\ILTCEV\_Lower\_Thames\_Crossing\010Geomatics\03 GIS Projects - LTC3020\Figures\TC3020\_Figure\_19\_(2021).mxd\benjamin.brown\*29/09/2021

Contains Ordnance Survey data © Crown copyright and database right 2020, provided by client

Figure 19: Detailed plan of Trenches 169, 170, 177, 179, 183 and 184

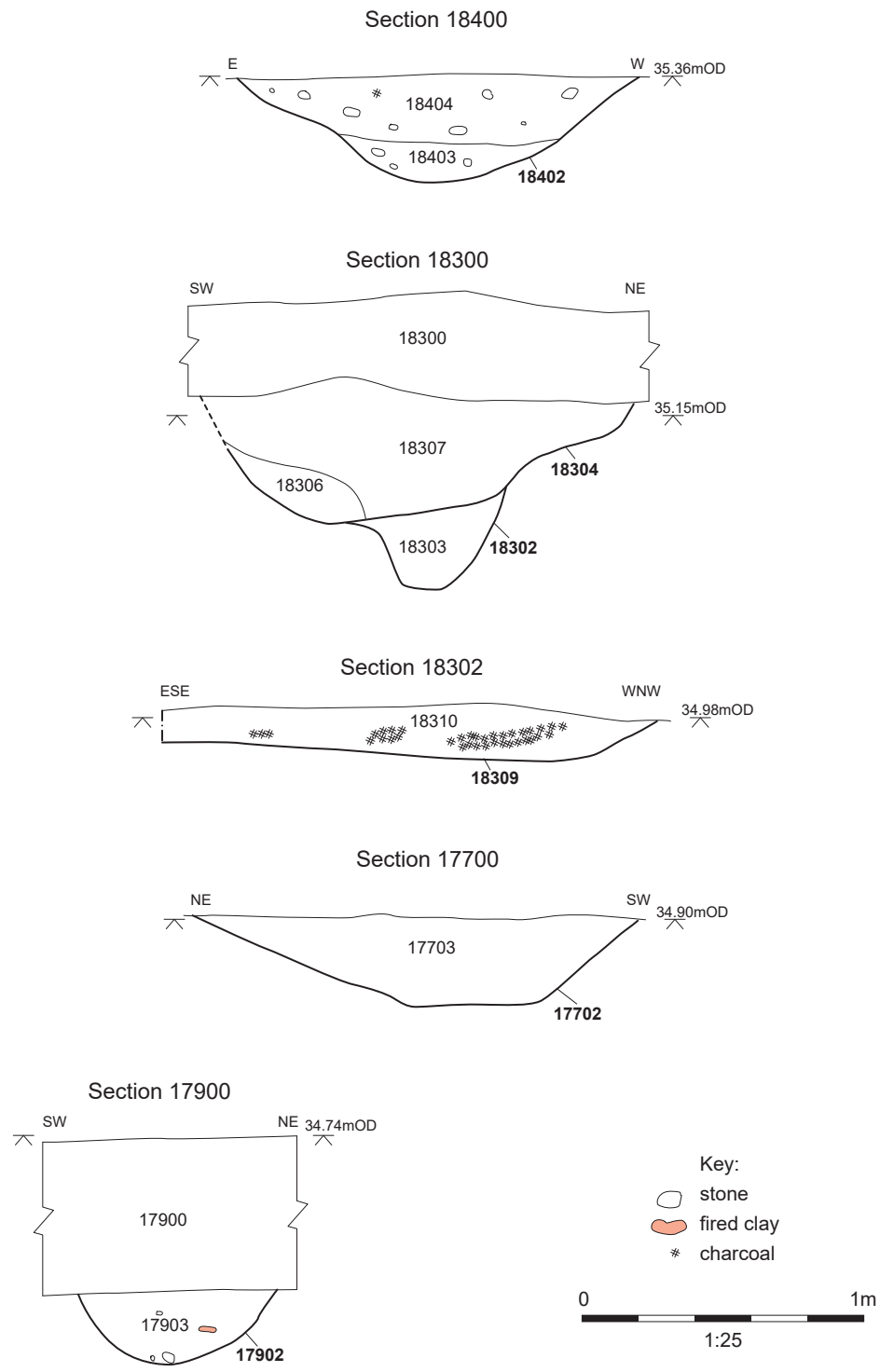

Figure 20: Sections, Trenches 177, 179, 183 and 184

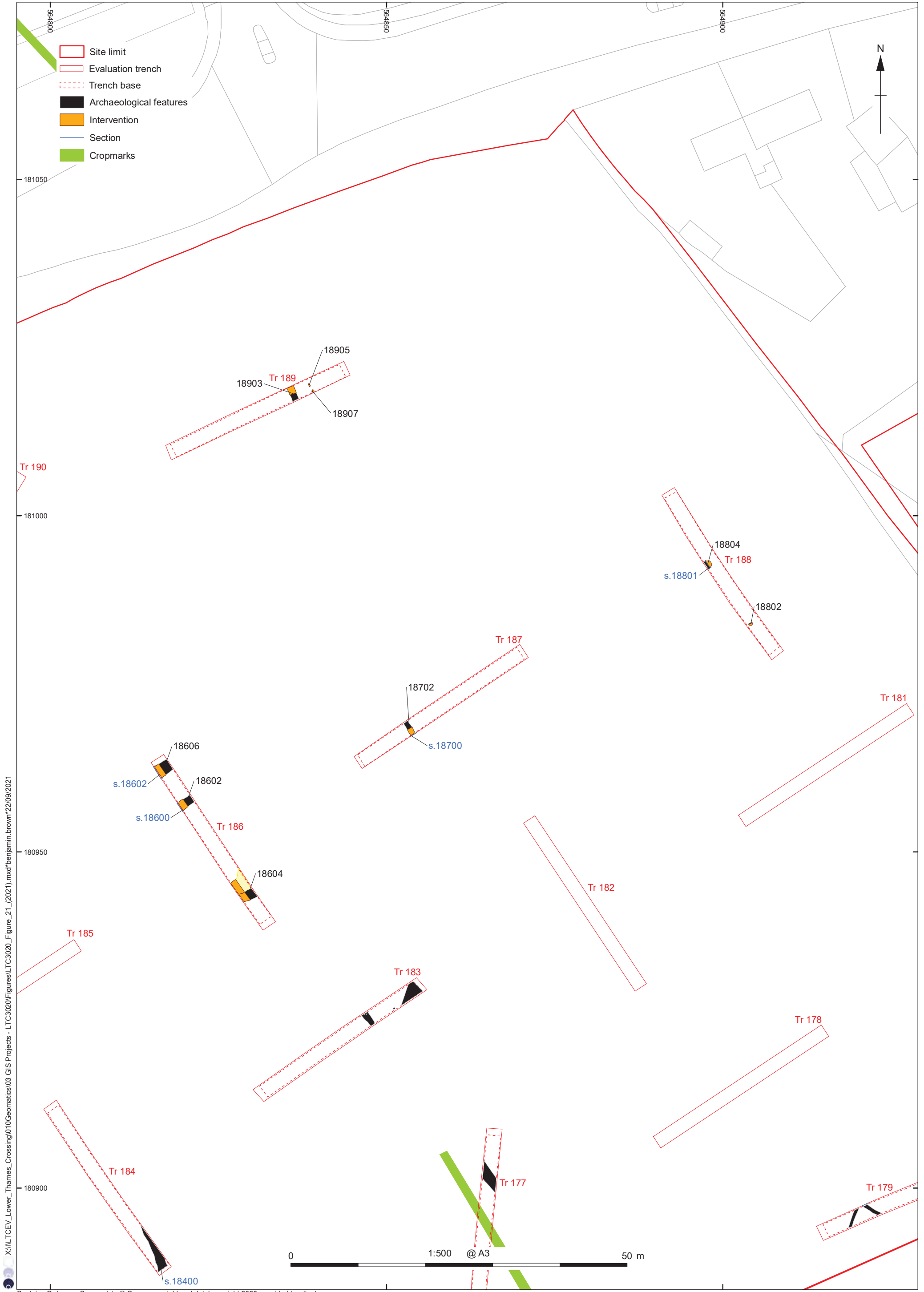

Figure 21: Detailed plan of Trenches 186-9

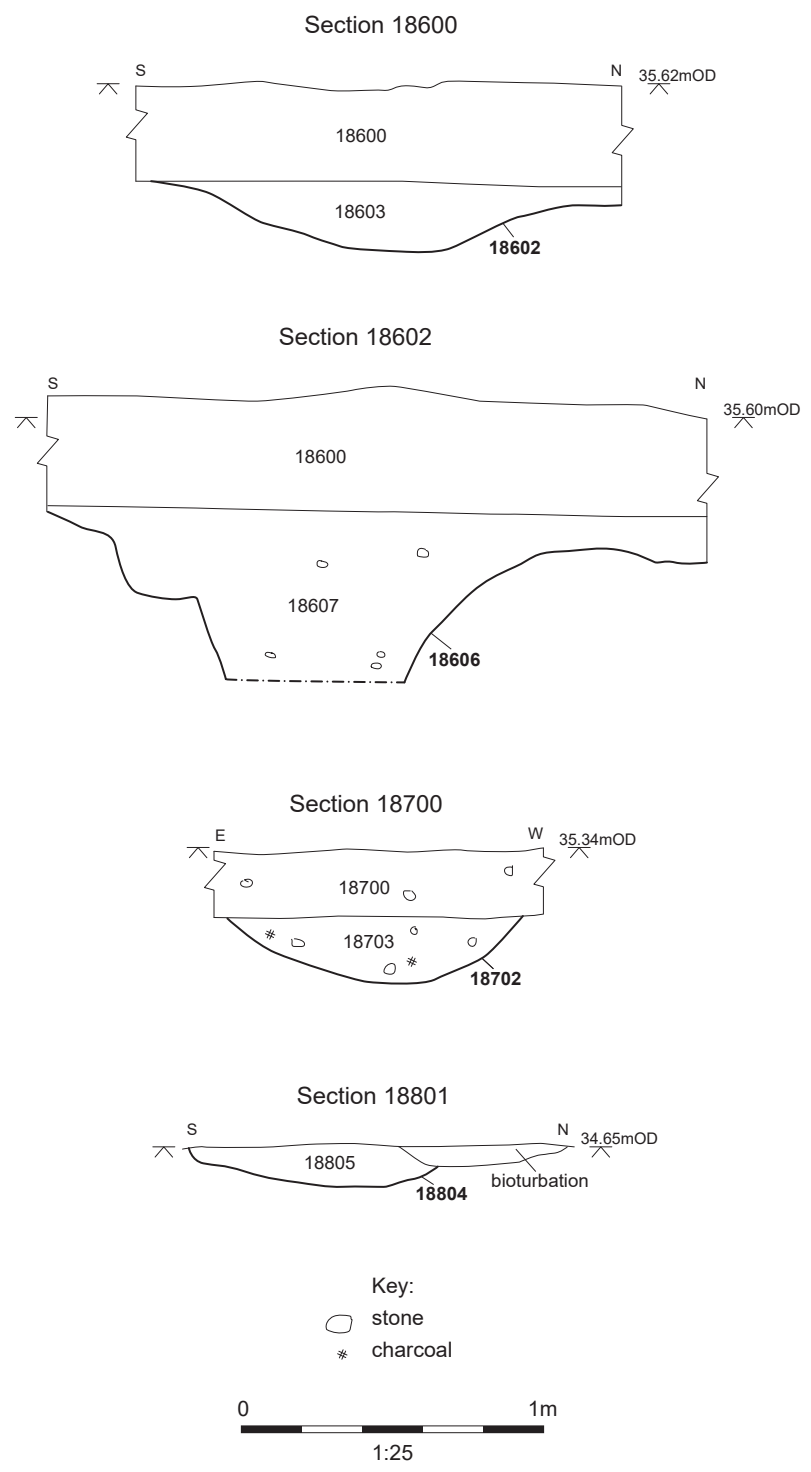

Figure 22: Sections, Trenches 186-8



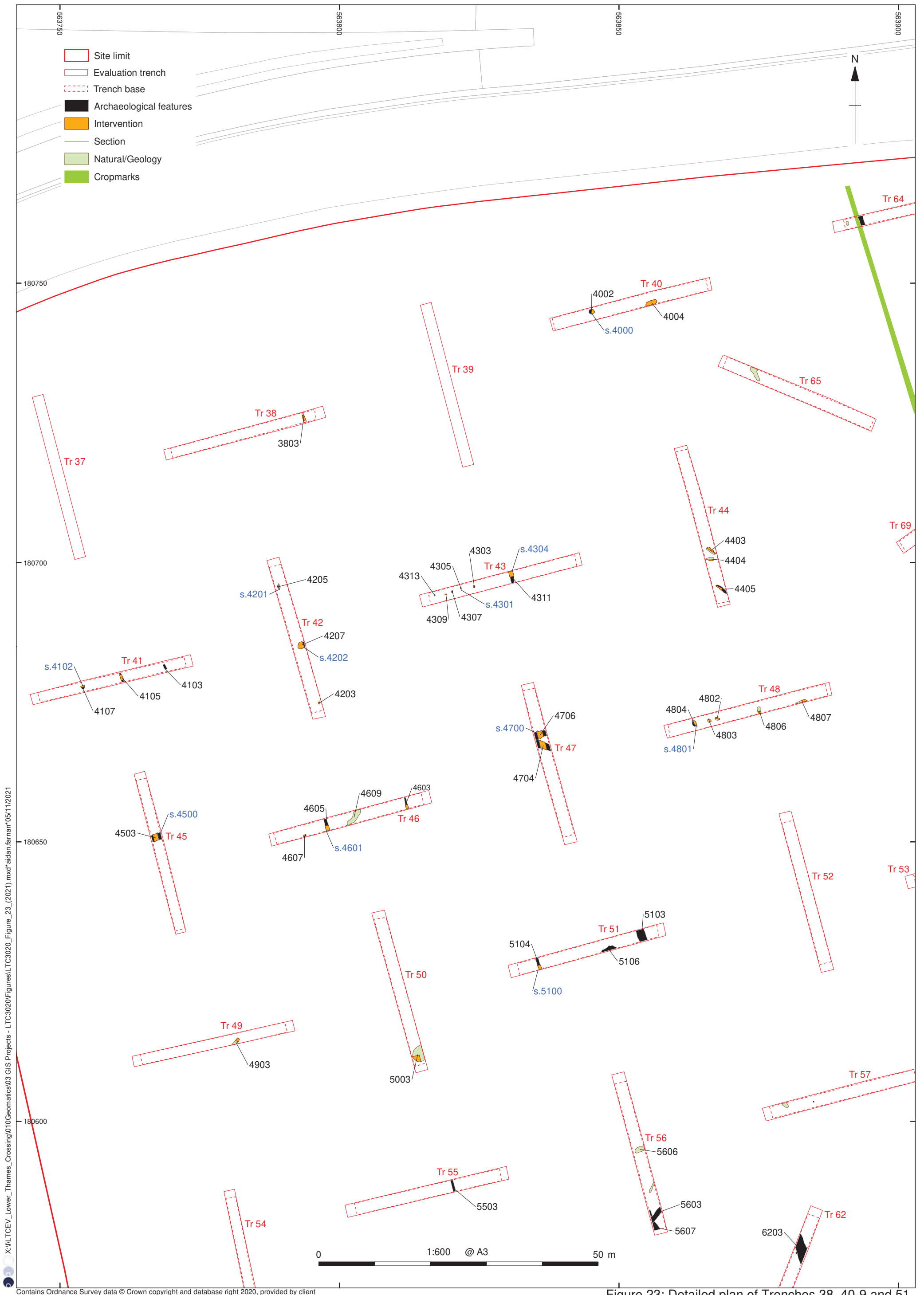

Figure 23: Detailed plan of Trenches 38, 40-9 and 51

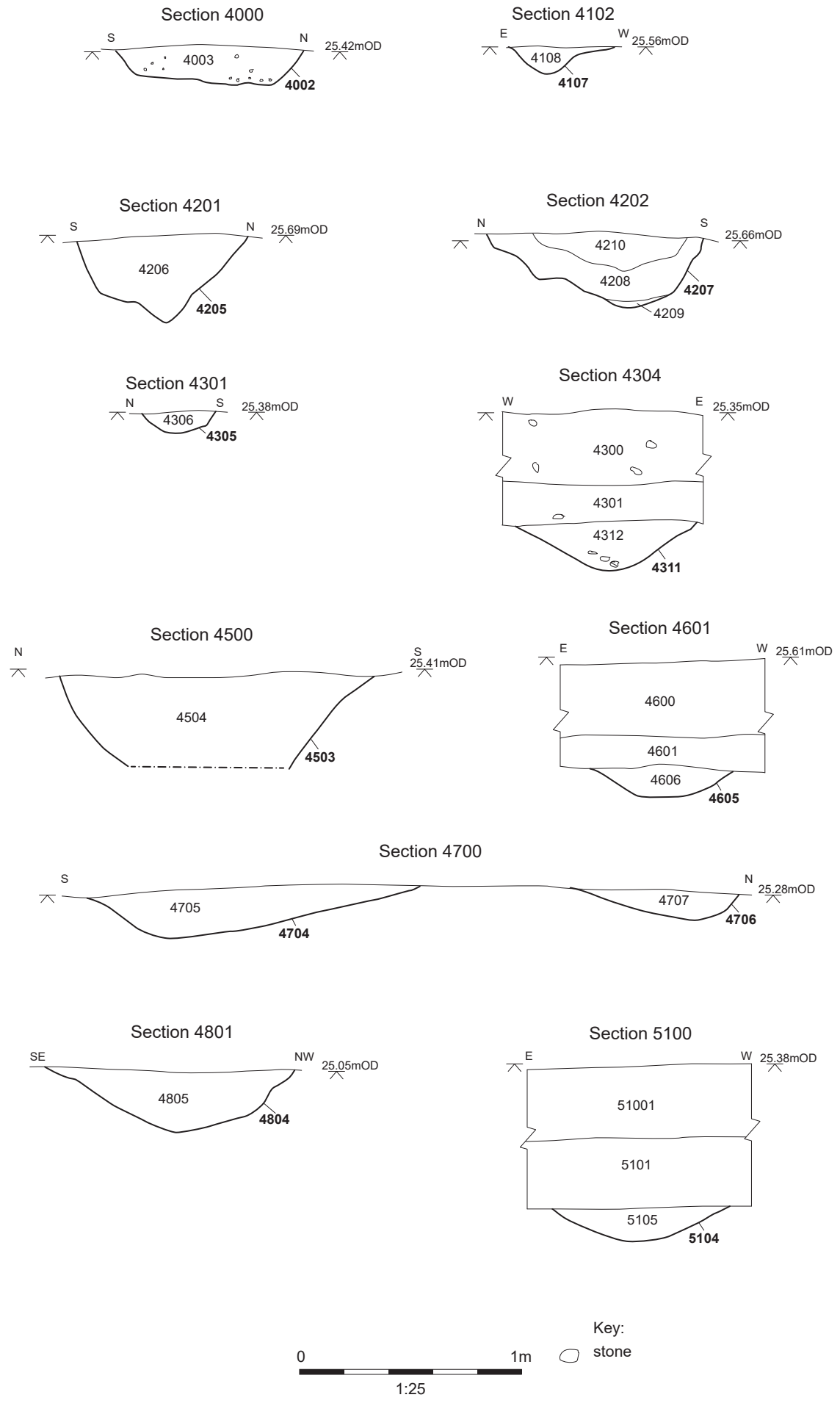
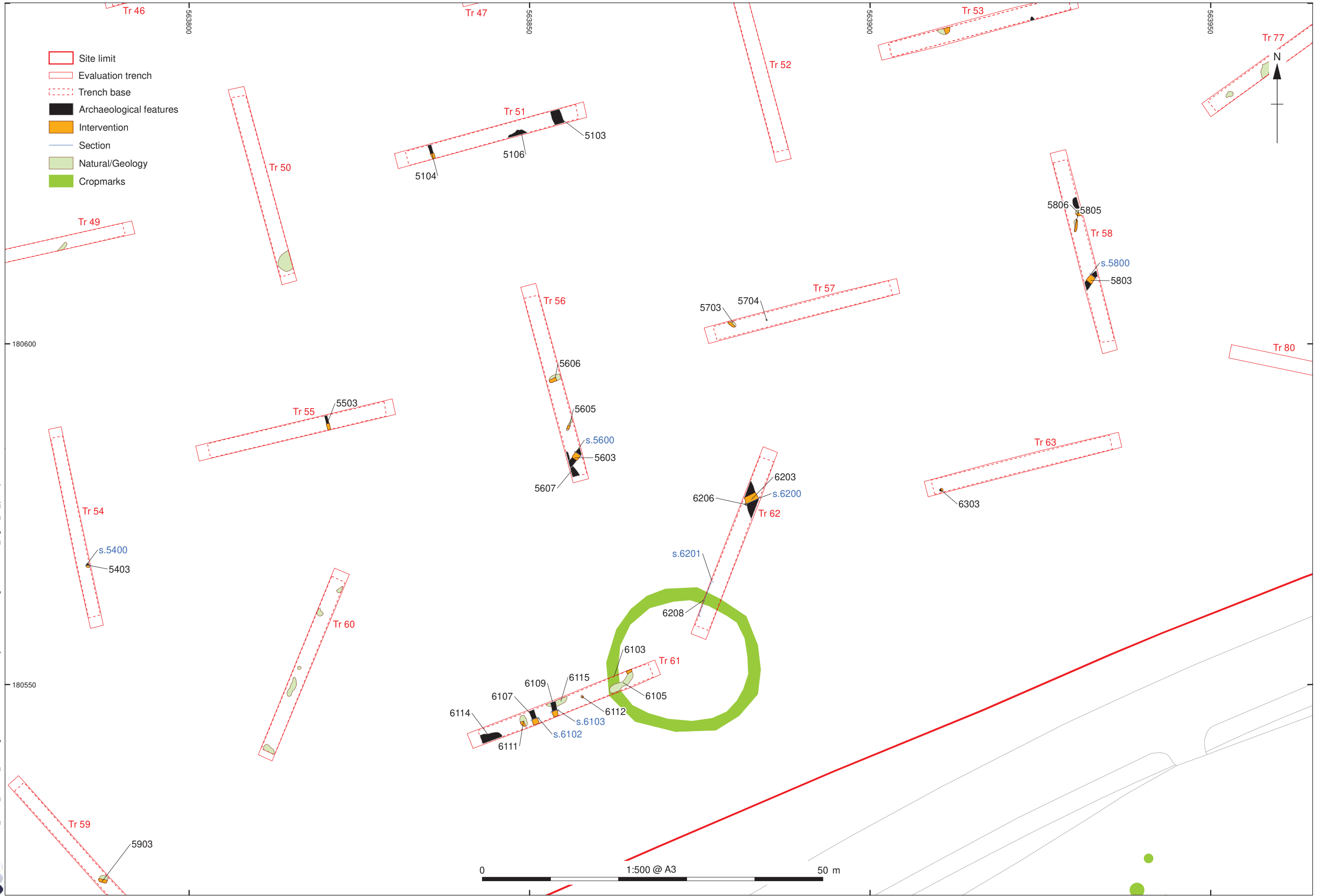

Figure 24: Sections, Trenches 40-3, 45-8 and 51

X:\ILTCEV\_Lower\_Thames\_Crossing\010Geomatics\03 GIS Projects - LTC3020\Figures\LTC3020\_Figure\_25\_(2021).mxd\aidan.farnan\05/11/2021



Contains Ordnance Survey data © Crown copyright and database right 2020, provided by client

Figure 25: Detailed plan of Trenches 51, 54-9 and 61-3

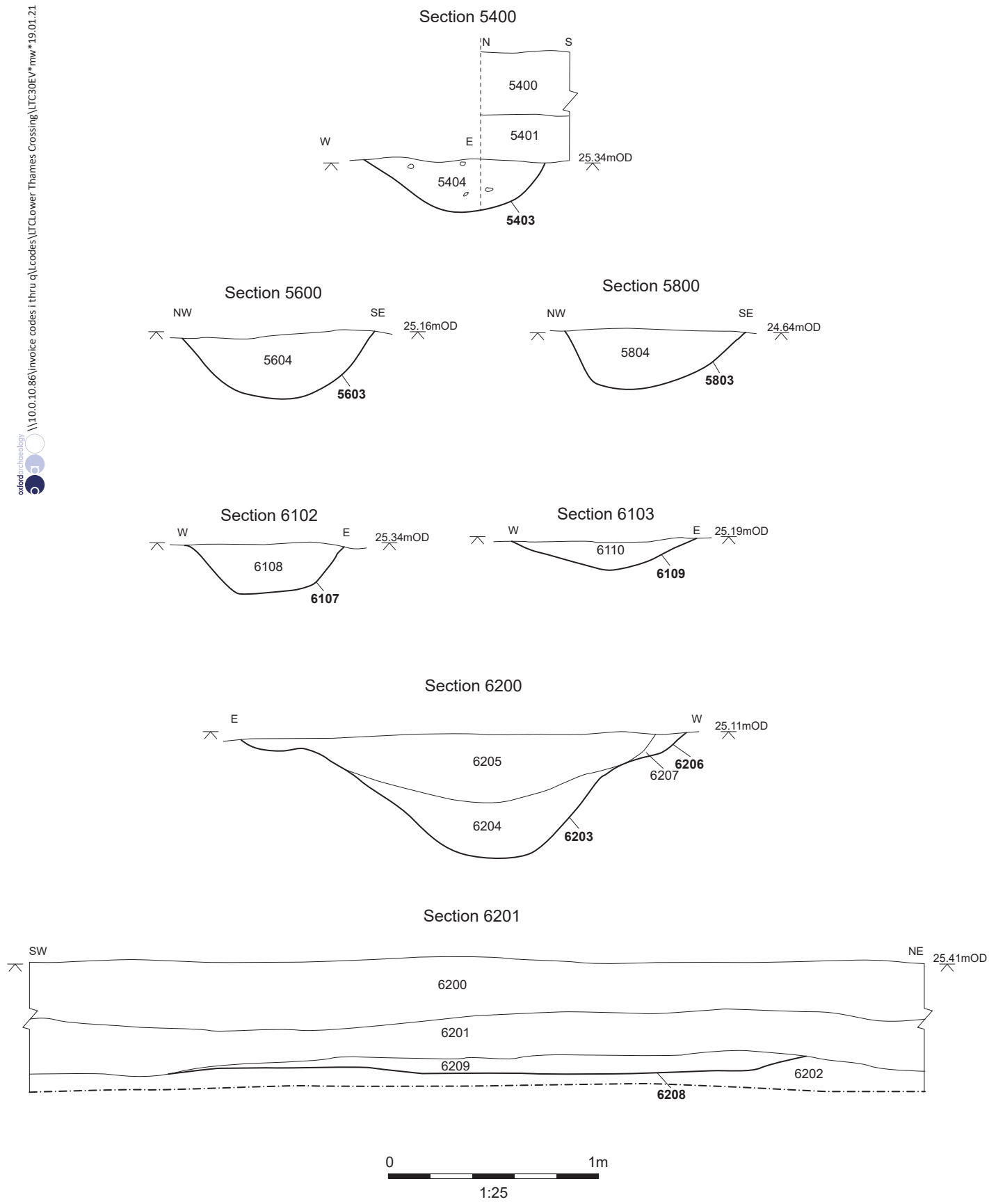
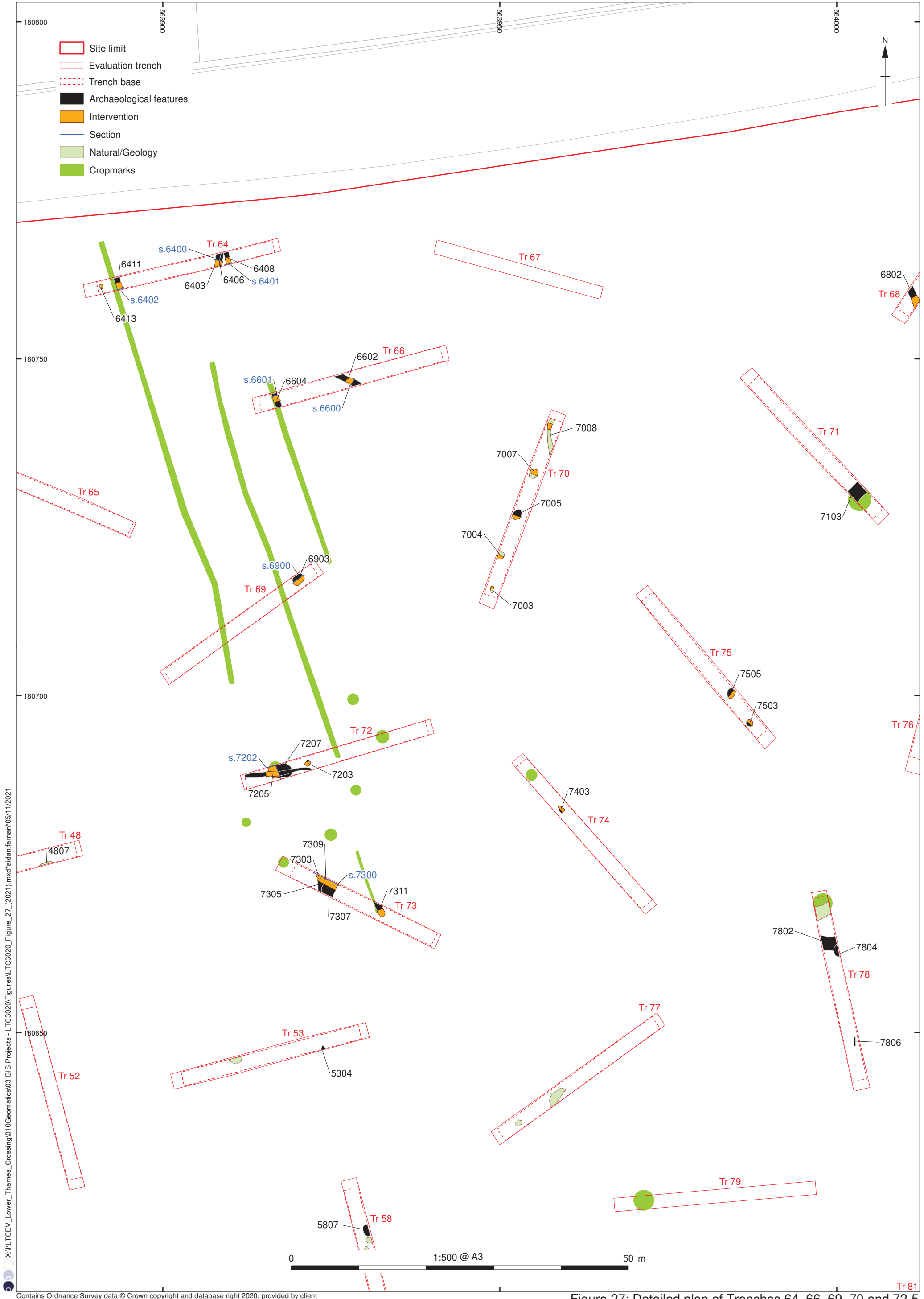

Figure 26: Sections, Trenches 54, 56, 58, 61 and 62



X:\ILTCEV\_Lower\_Thames\_Crossing\010\Geomatics\03 GIS Projects - ITC3020\Figures\TC3020\_Figure\_27\_(2021).mxd\*aidan.farman\*05/11/2021

Contains Ordnance Survey data © Crown copyright and database right 2020, provided by client

Figure 27: Detailed plan of Trenches 64, 66, 69, 70 and 72-5

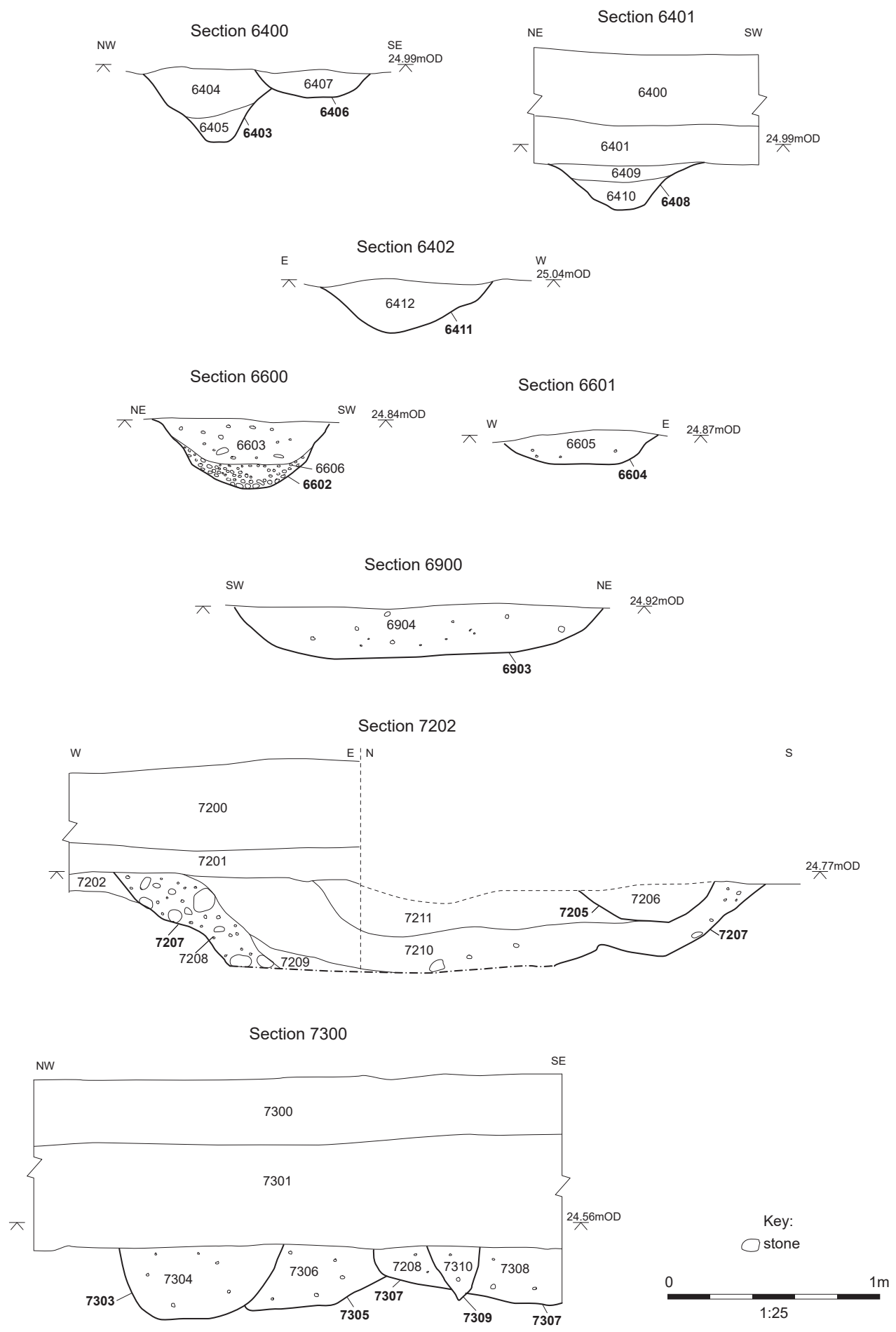

Figure 28: Sections, Trenches 64, 66, 69 and 72-3

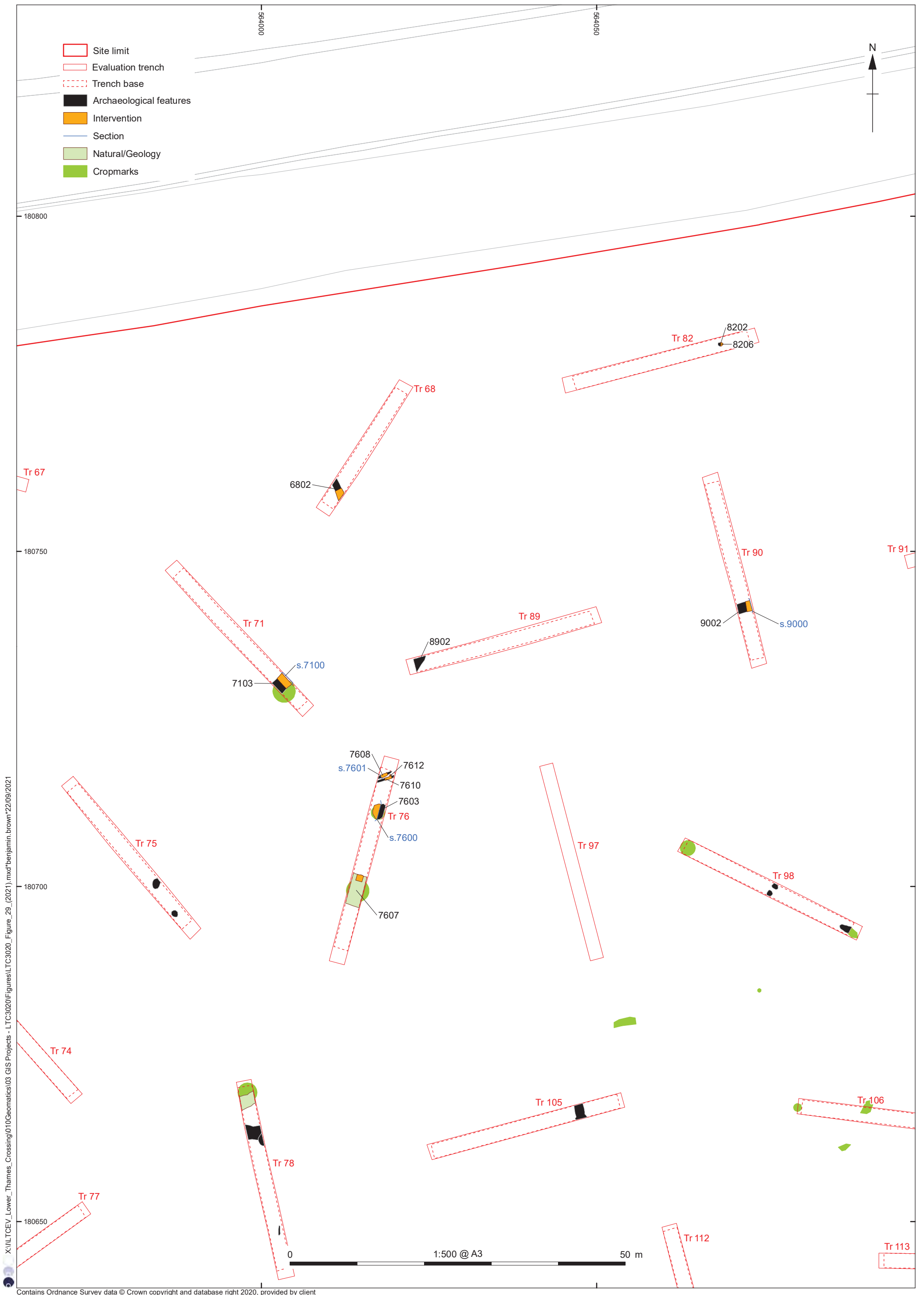

Figure 29: Detailed plan of Trenches 68, 71, 76, 82, 89 and 90

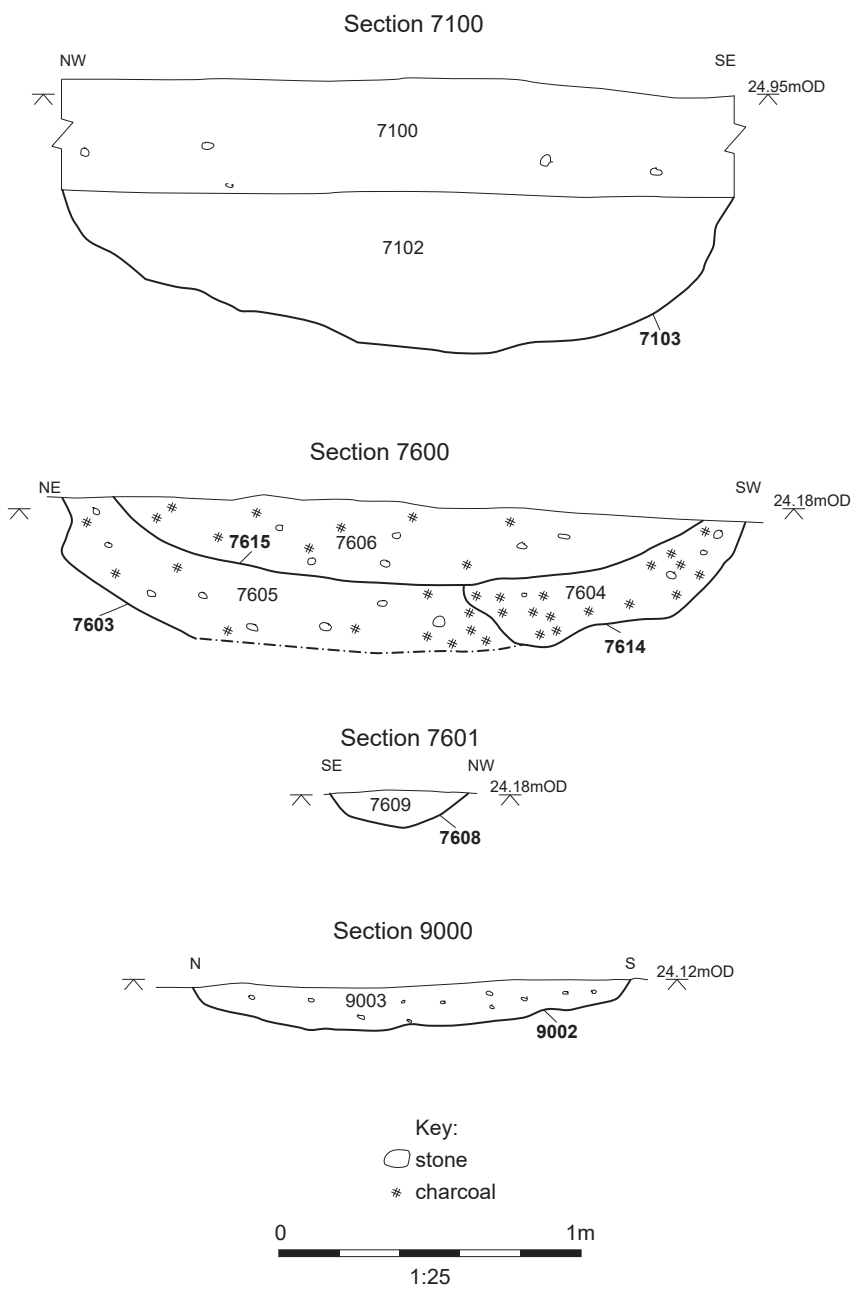
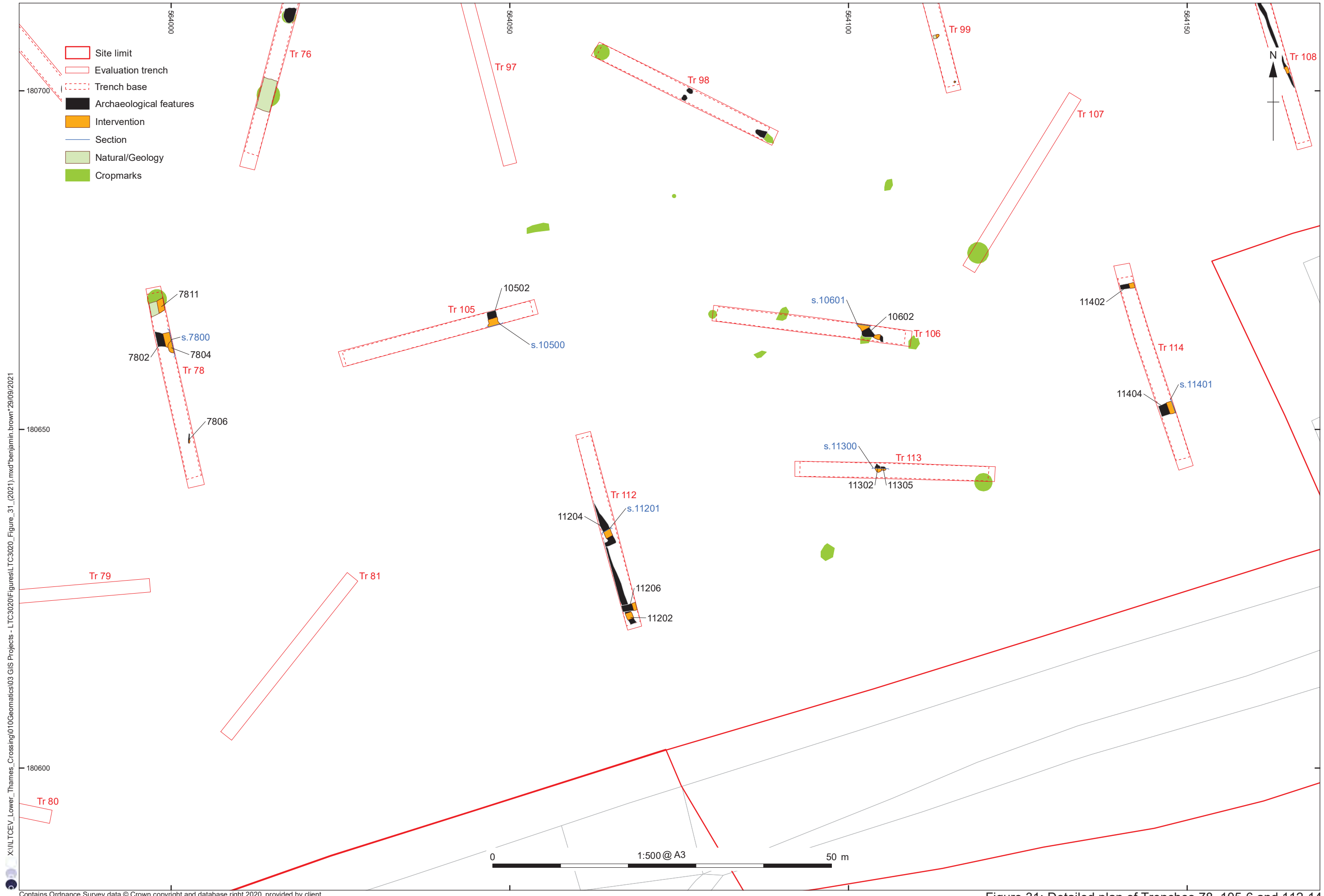

Figure 30: Sections, Trenches 71, 76 and 90





X:\ILTCEV\_Lower\_Thames\_Crossing\010\Geomatics\03 GIS Projects - LTC3020\Figures\TC3020\_Figure\_31\_(2021).mxd\benjamin.brown\*29/09/2021

Contains Ordnance Survey data © Crown copyright and database right 2020, provided by client

Figure 31: Detailed plan of Trenches 78, 105-6 and 112-14

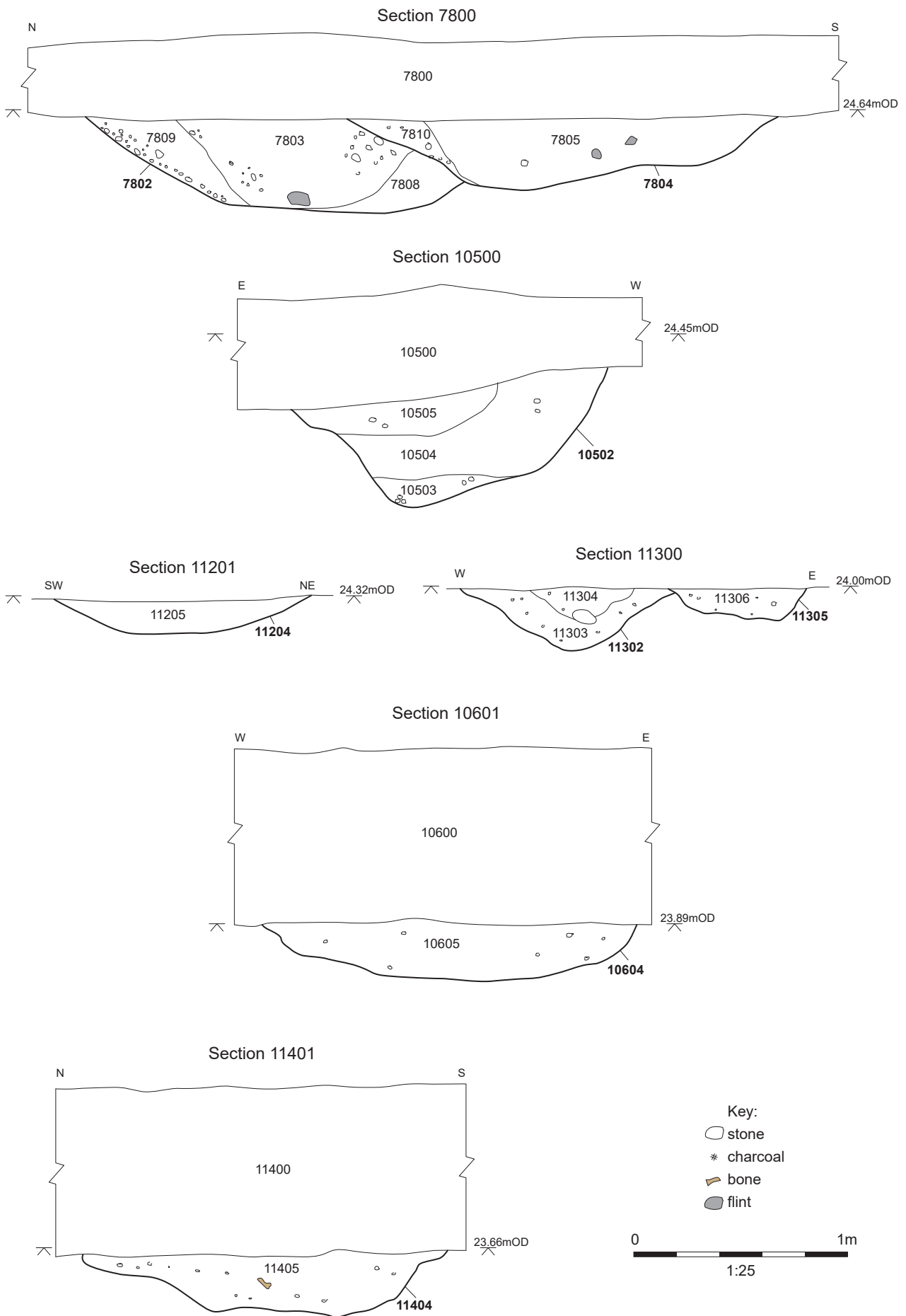
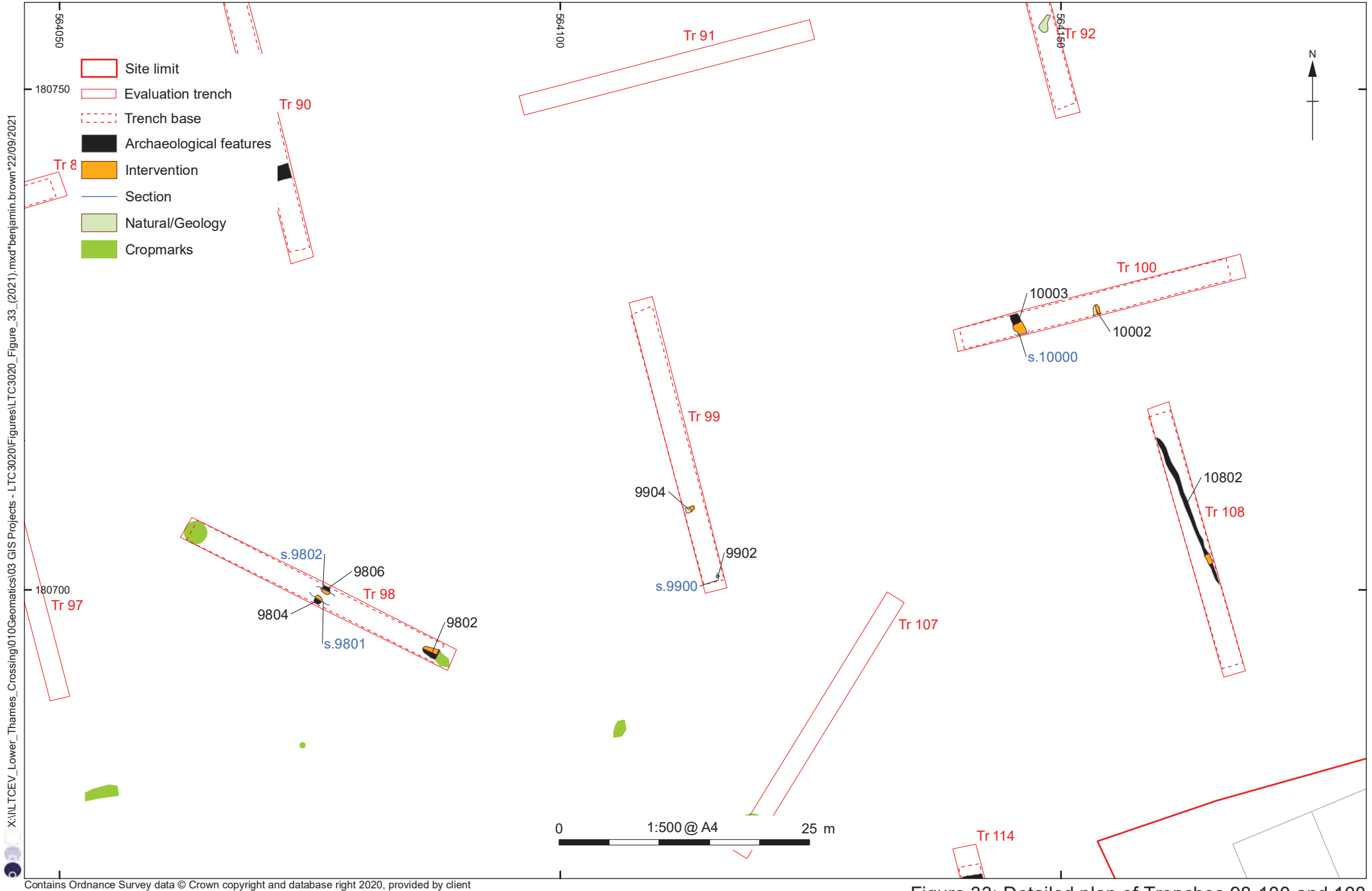

Figure 32: Sections, Trenches 78, 105-6 and 112-14



X:\ILT\CEV\_Lower\_Thames\_Crossing\010\Geomatics\03 GIS Projects - LTC3020\Figures\LTC3020\_Figure\_33\_(2021).mxd\benjamin.brown\22/09/2021

Contains Ordnance Survey data © Crown copyright and database right 2020, provided by client

Figure 33: Detailed plan of Trenches 98-100 and 108

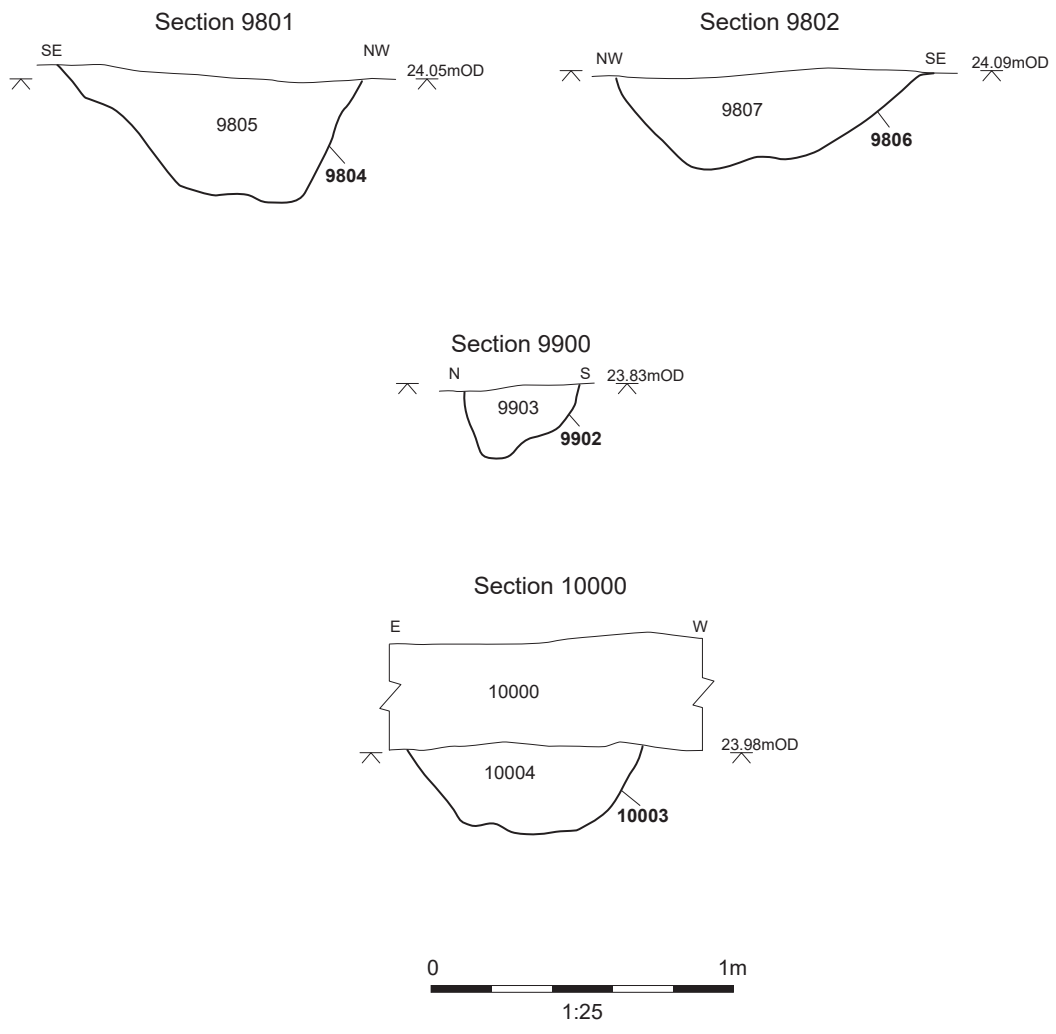
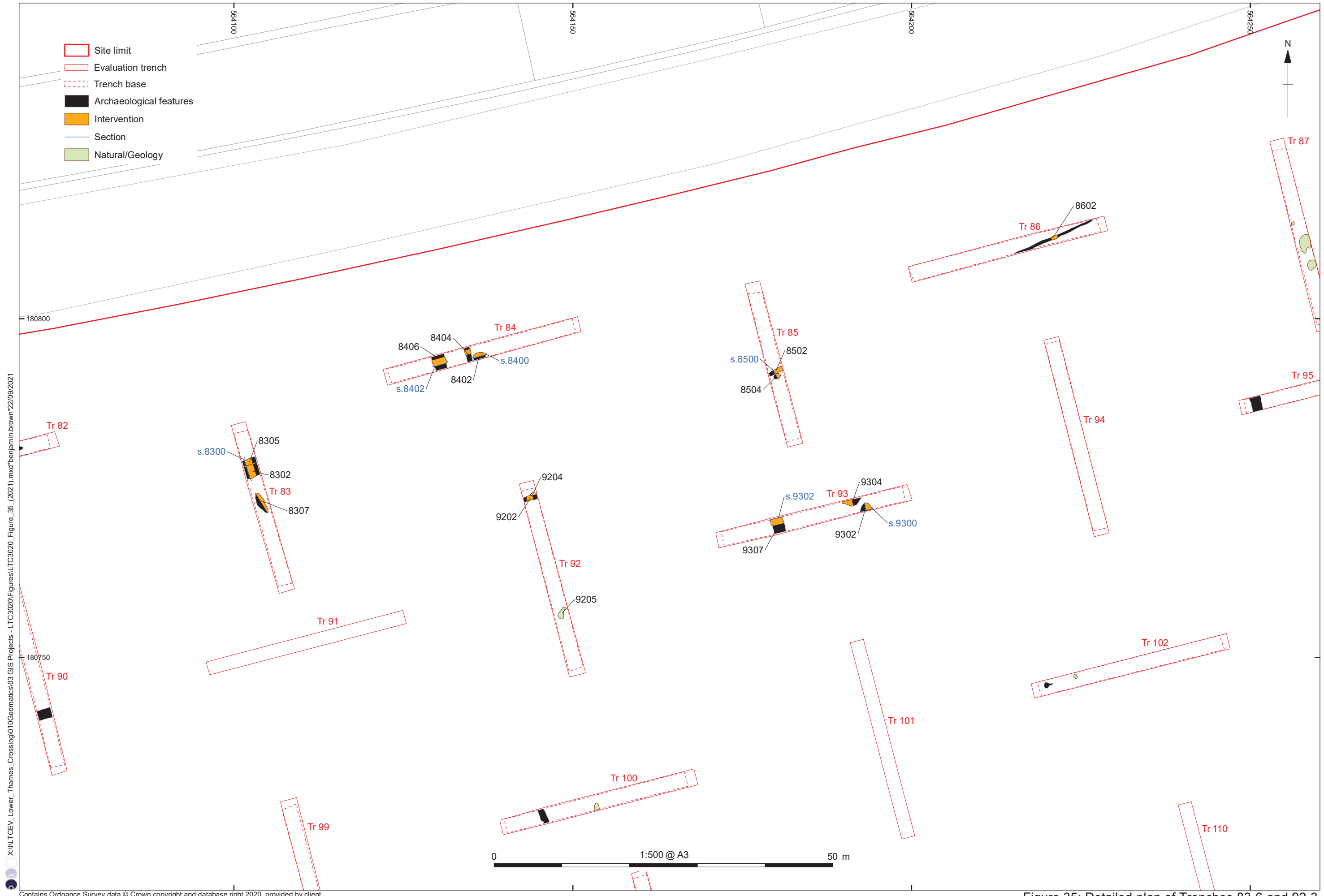

Figure 34: Sections of Trenches 98-100



X:\ILTCEV\_Lower\_Themes\_Crossing\010Geomatics\03 GIS Projects - LTC3020\Figures\TC3020\_Figure\_35\_(2021).mxd\benjamin.brown\22/09/2021

Contains Ordnance Survey data © Crown copyright and database right 2020, provided by client

Figure 35: Detailed plan of Trenches 83-6 and 92-3

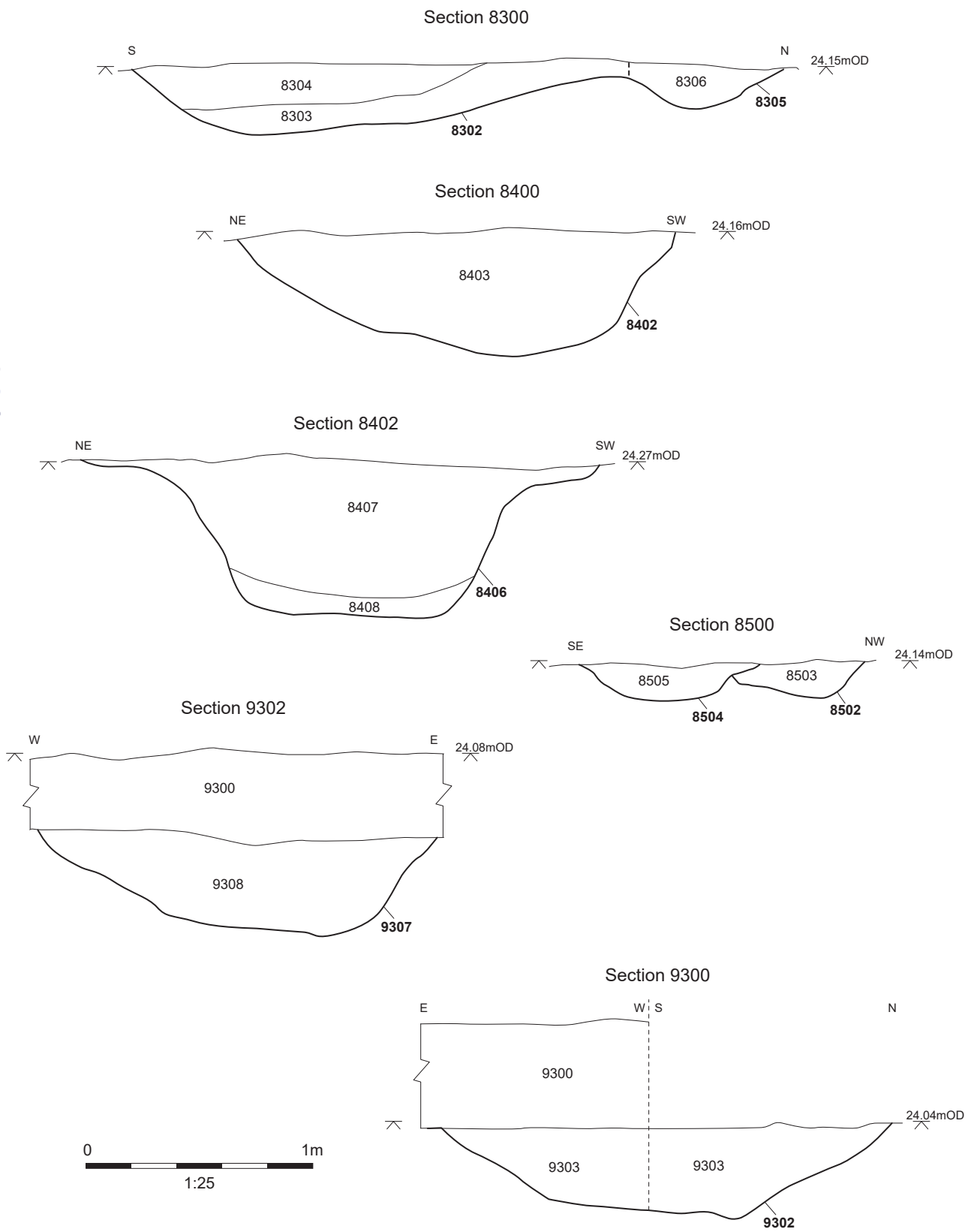
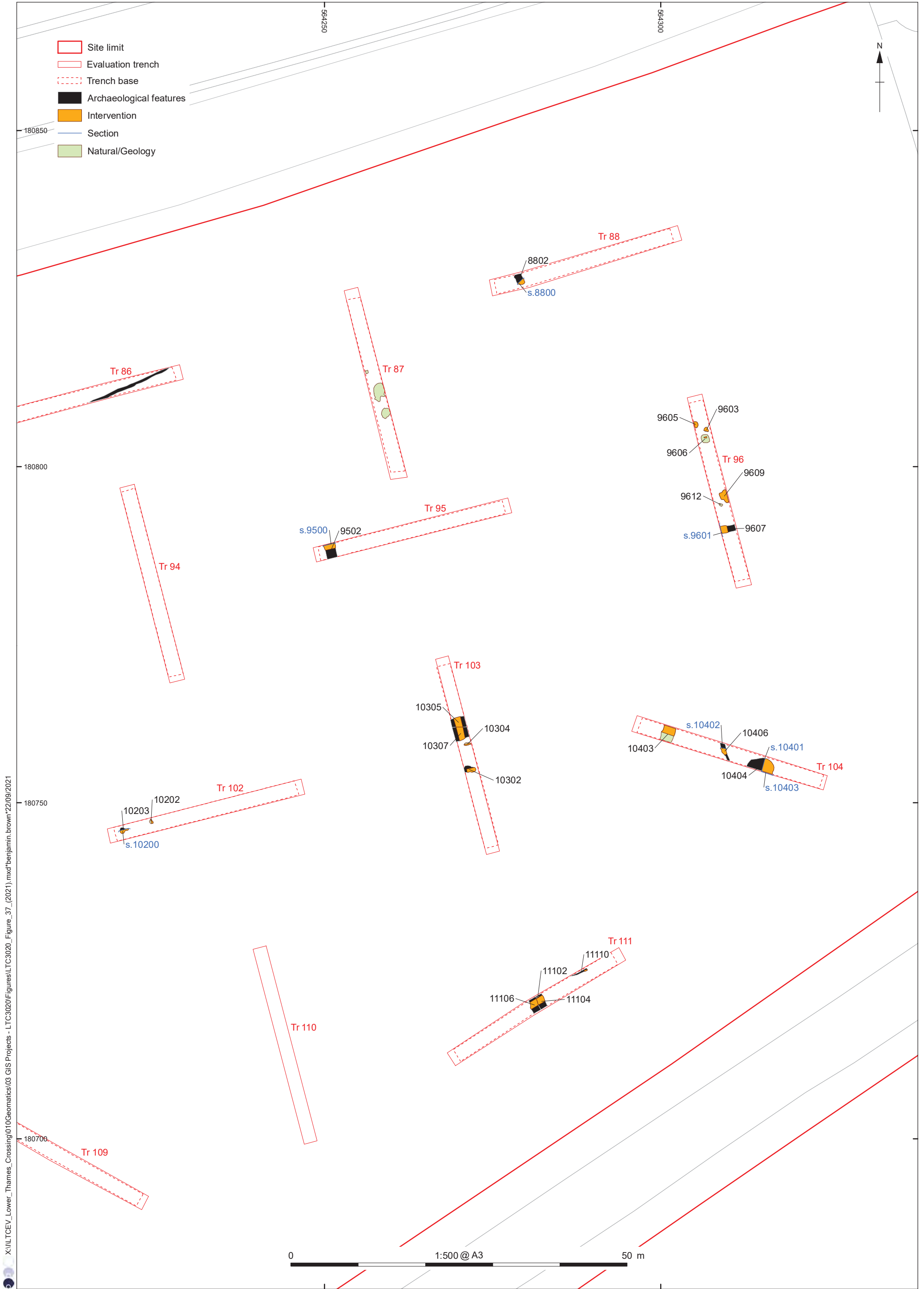

Figure 36: Sections, Trenches 83-5 and 93



X:\ILTCEV\_Lower\_Thames\_Crossing\010\Geomatics\03 GIS Projects - LTC3020\Figures\LTC3020\_Figure\_37\_(2021).mxd\benjamin.brown\22/09/2021

Contains Ordnance Survey data © Crown copyright and database right 2020, provided by client

Figure 37: Detailed plan of Trenches 88, 95-6, 102-4 and 111

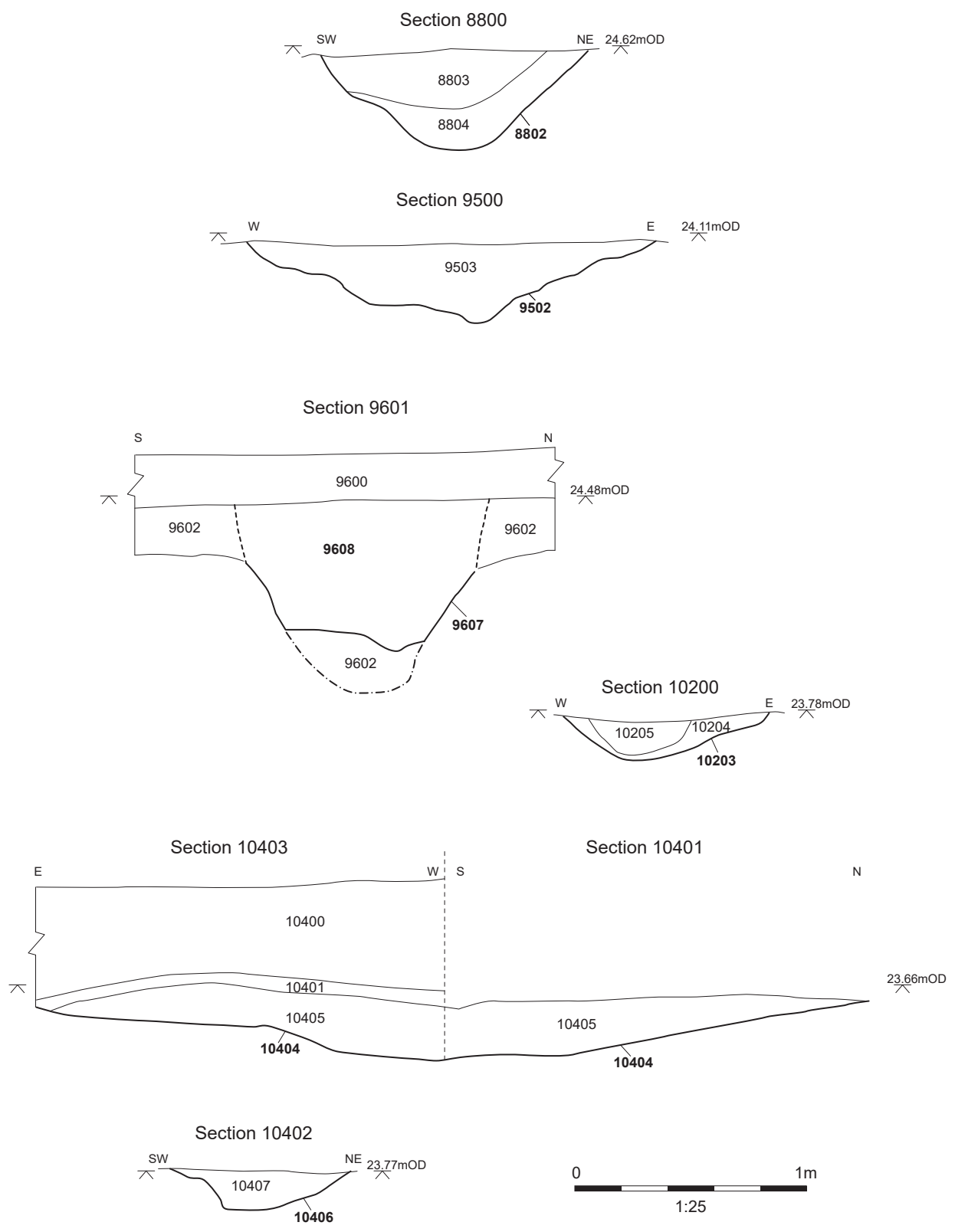
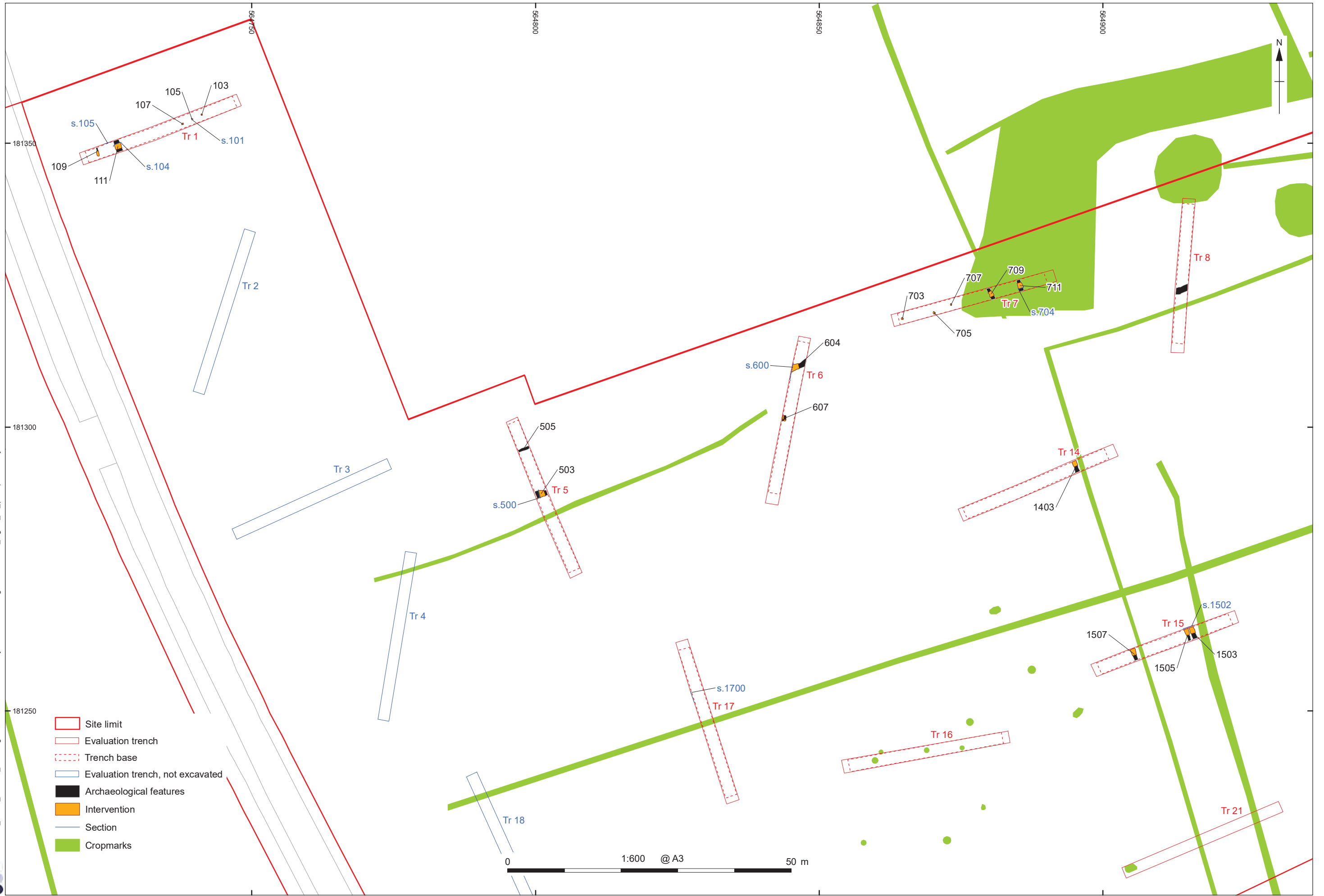

Figure 38: Sections, Trenches 88, 95-6, 102 and 104



X:\ILTCEV\_Lower\_Thames\_Crossing\010\Geomatics\03 GIS Projects - LTC3020\Figures\LTC3020\_Figure\_39\_(2021).mxd\benjamin.brown\22/09/2021



Contains Ordnance Survey data © Crown copyright and database right 2020, provided by client

Figure 39: Detailed plan of Trenches 1, 5-7, 14-15 and 17

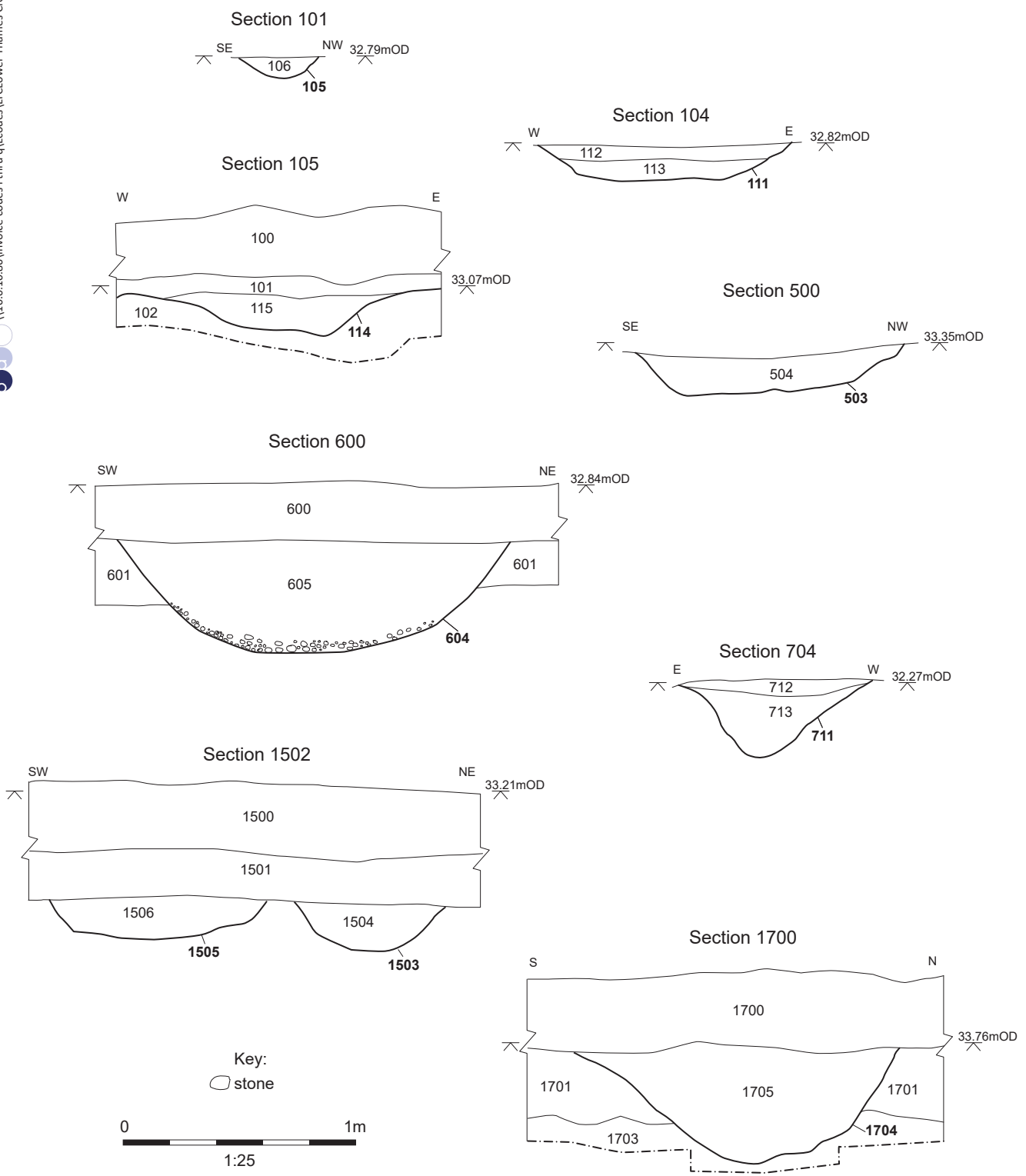
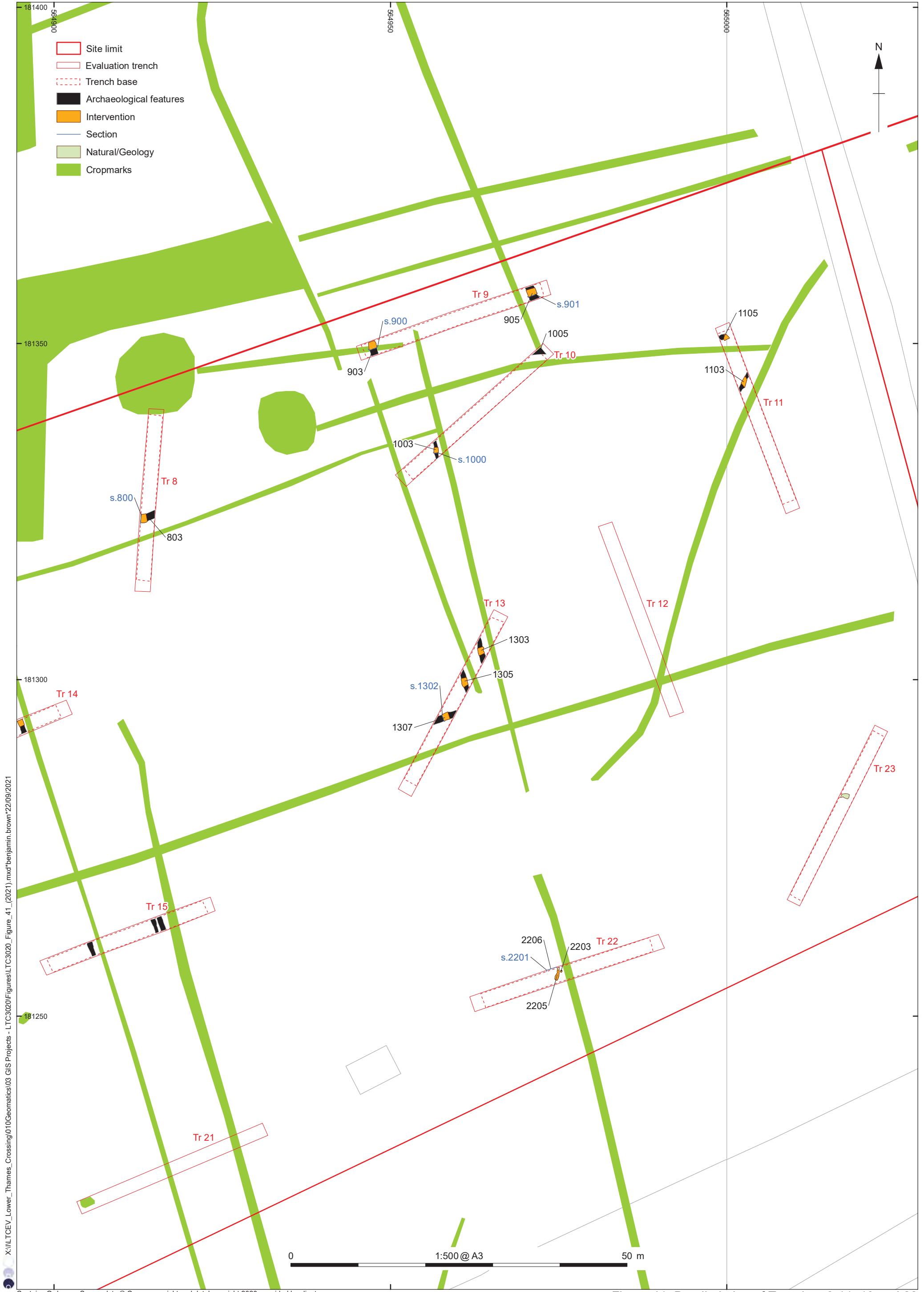

Figure 40: Sections, Trenches 1, 5-7, 15 and 17



X:\ILTCEV\_Lower\_Thames\_Crossing\010\Geomatics\03 GIS Projects - LTC3020\Figures\LTC3020\_Figure\_41\_(2021).mxd\benjamin.brown\*22/09/2021

Contains Ordnance Survey data © Crown copyright and database right 2020, provided by client

Figure 41: Detailed plan of Trenches 8-11, 13 and 22

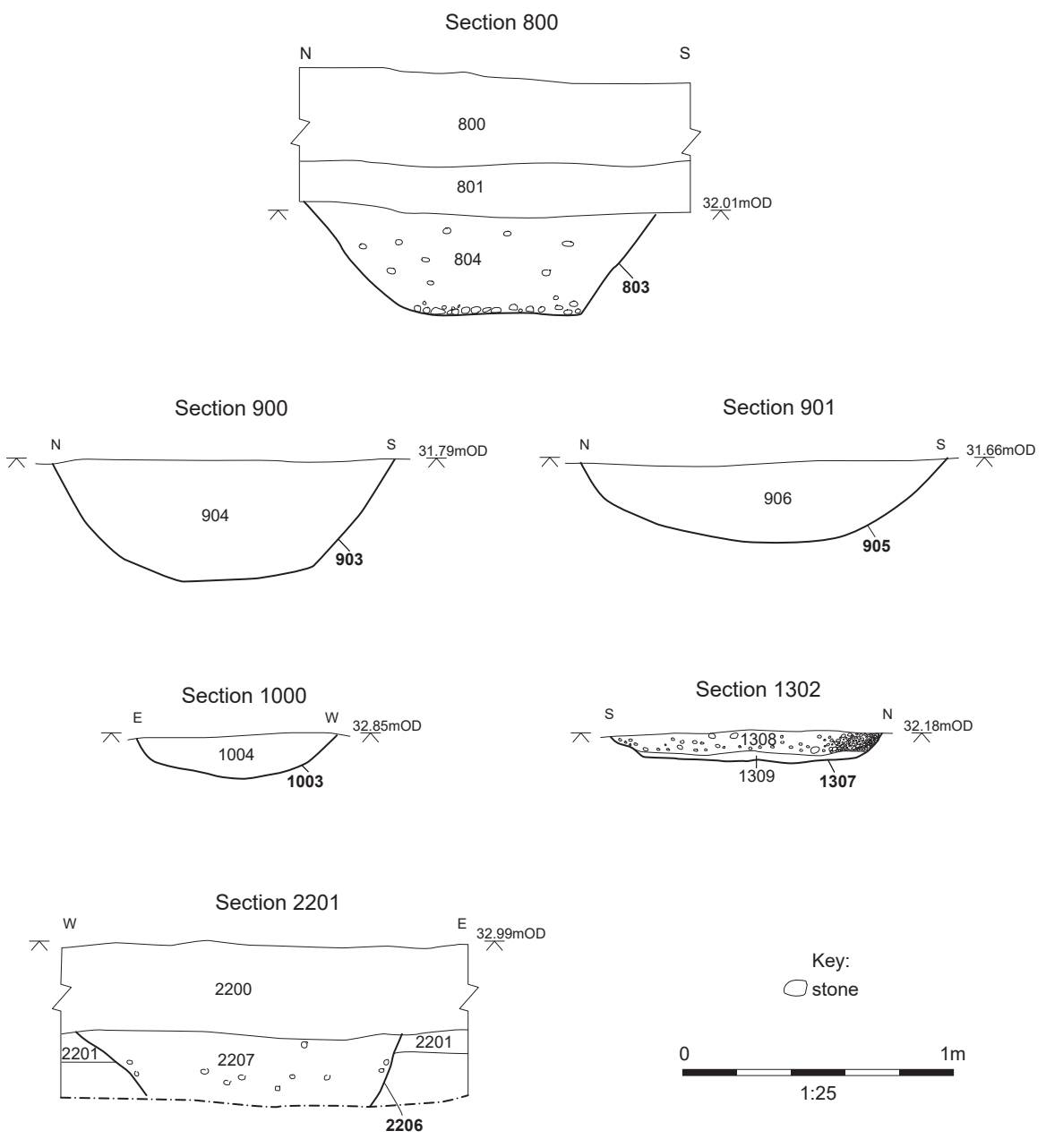

Figure 42: Sections, Trenches 8-10, 13 and 22



X:\ILTCEV\_Lower\_Thames\_Crossing\010\Geomatics\03 GIS Projects - LTC3020\Figures\LTC3020\_Figure\_43\_(2021).mxd\benjamin.brown\*22/09/2021

Contains Ordnance Survey data © Crown copyright and database right 2020, provided by client

Figure 43: Detailed plan of Trenches 24-5, and 27

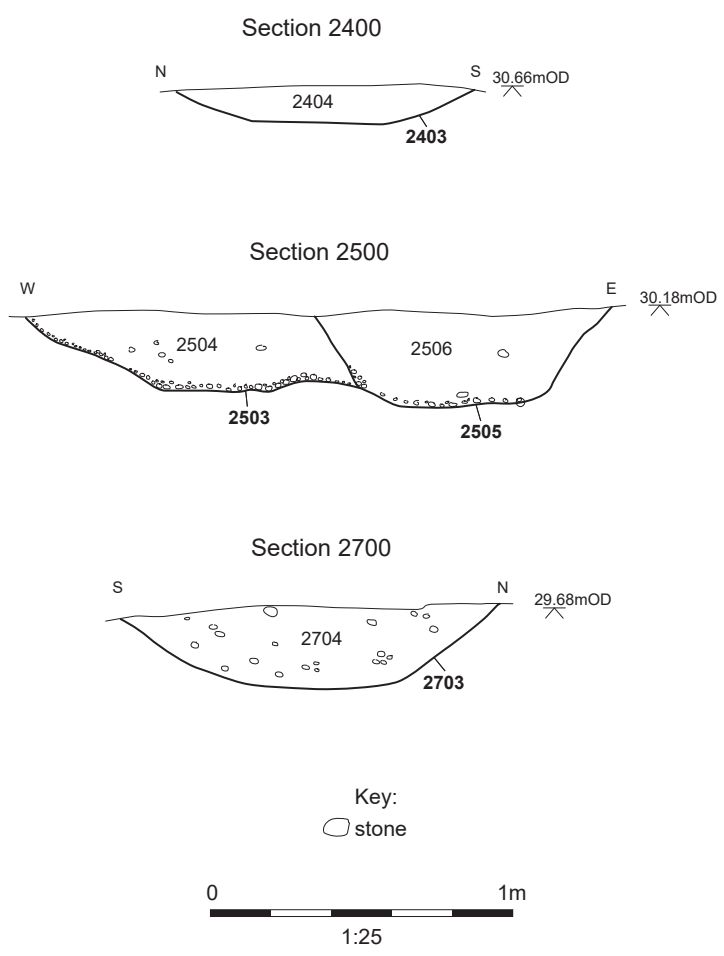
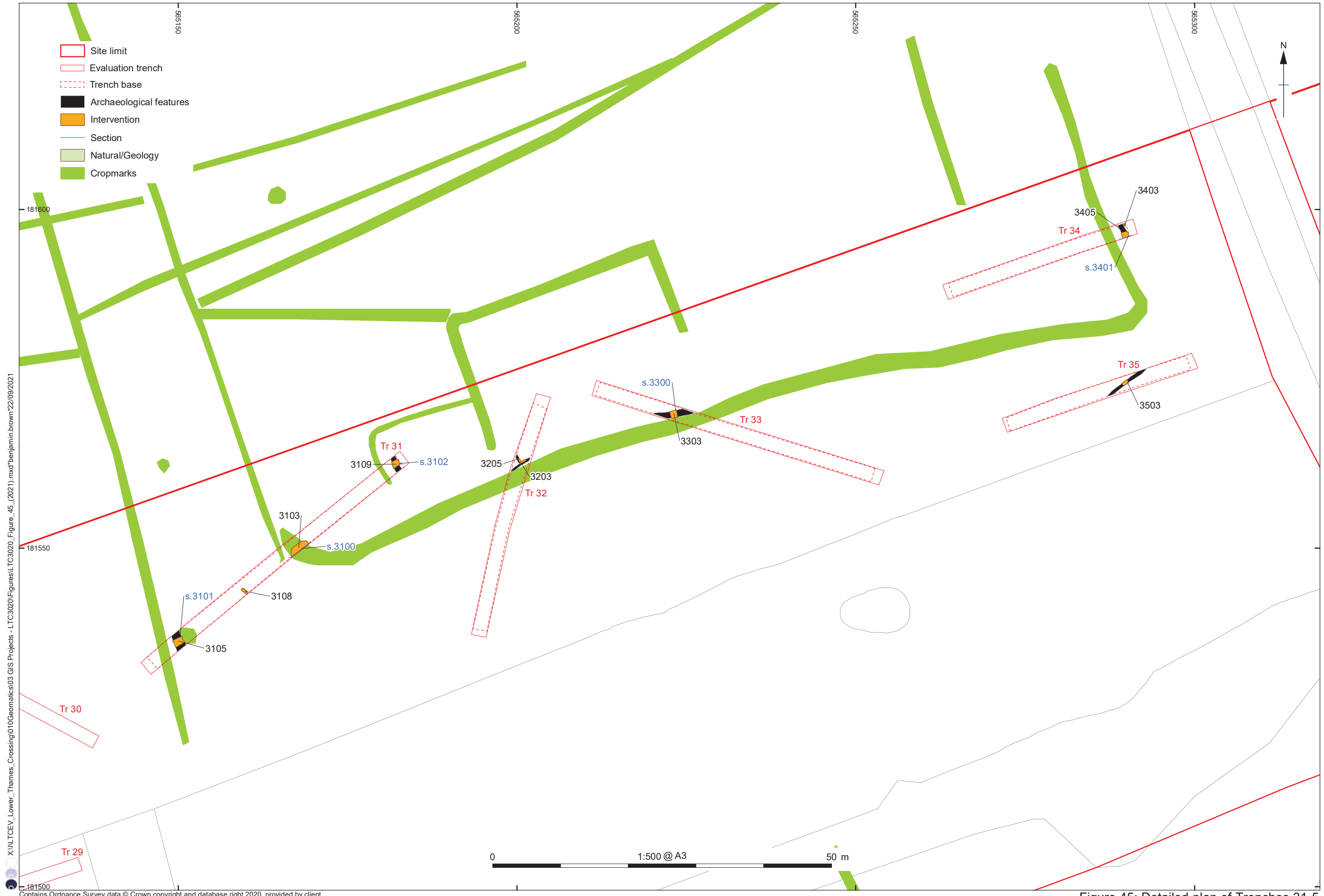

Figure 44: Sections, Trenches 24-5, and 27



X:\ILTCEV\_Lower\_Thames\_Crossing\010Geomatics\03 GIS Projects - LTC3020\Figures\TC3020\_Figure\_45\_(2021).mxd\benjamin.brown\22/09/2021

Contains Ordnance Survey data © Crown copyright and database right 2020, provided by client

Figure 45: Detailed plan of Trenches 31-5

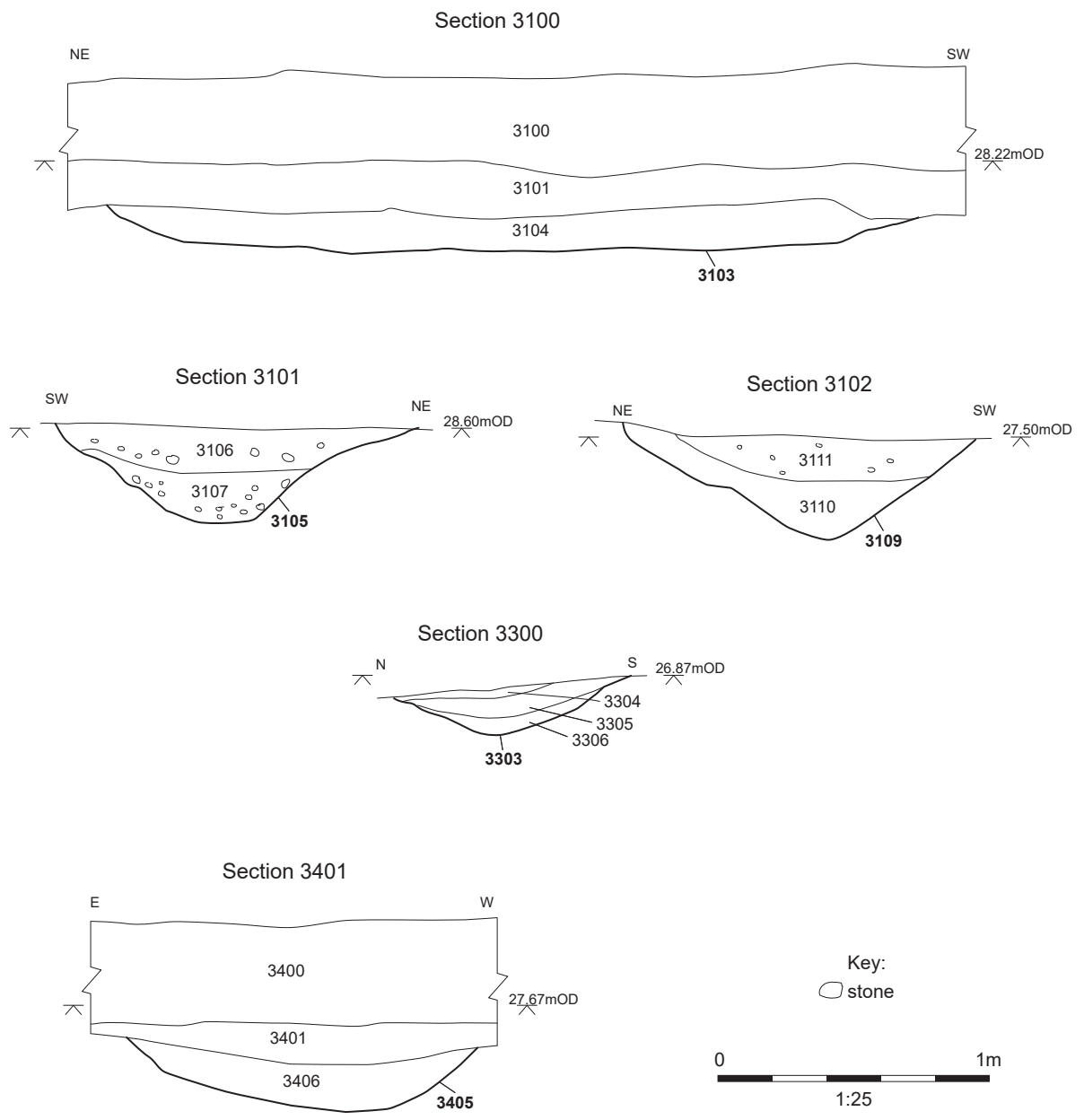
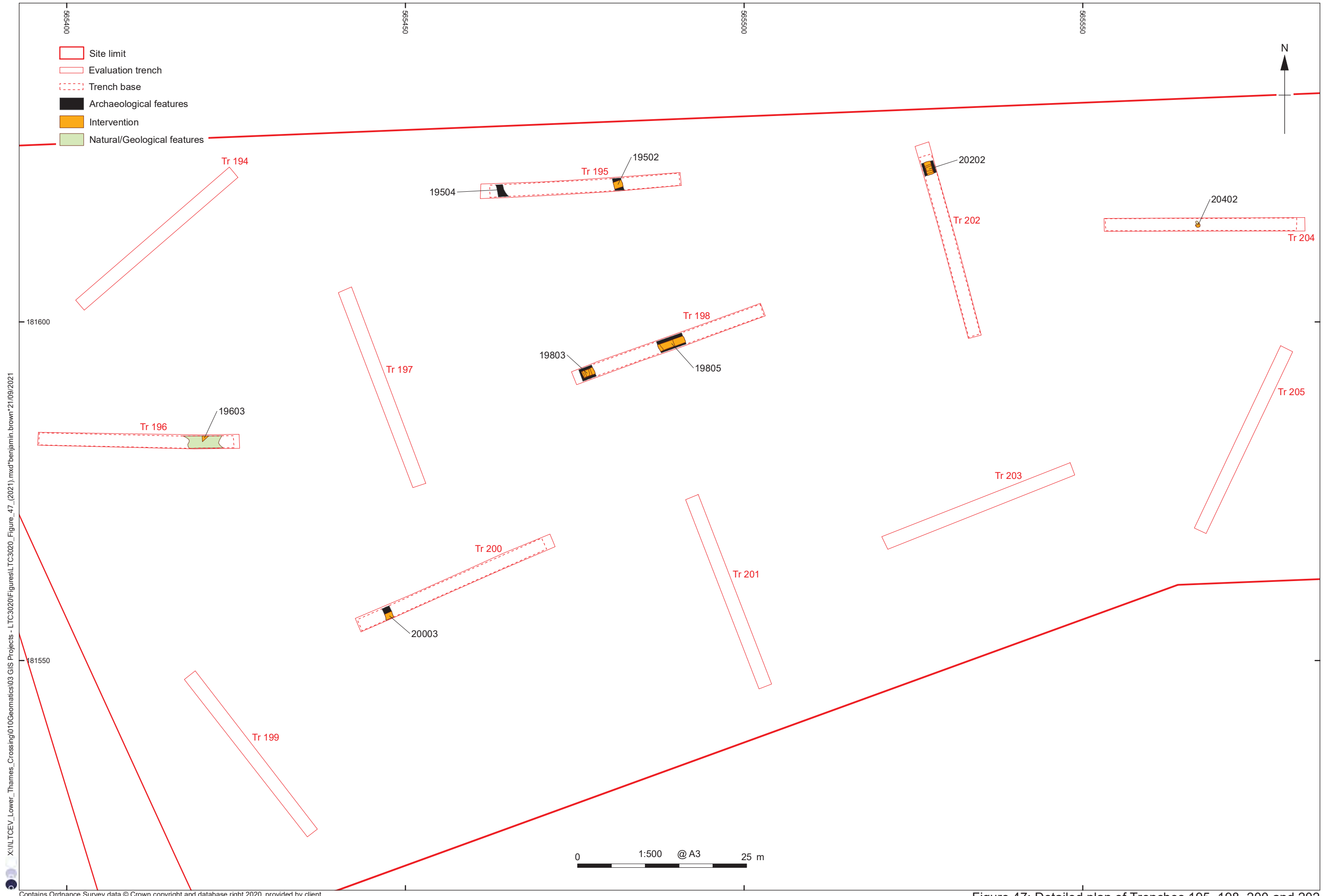

Figure 46: Sections, Trenches 31 and 33-4





X:\ILTCEV\_Lower\_Thames\_Crossing\010\Geomatics\03 GIS Projects - LTC3020\Figures\TC3020\_Figure\_47\_(2021).mxd\benjamin.brown\*21/09/2021

Contains Ordnance Survey data © Crown copyright and database right 2020, provided by client

Figure 47: Detailed plan of Trenches 195, 198, 200 and 202

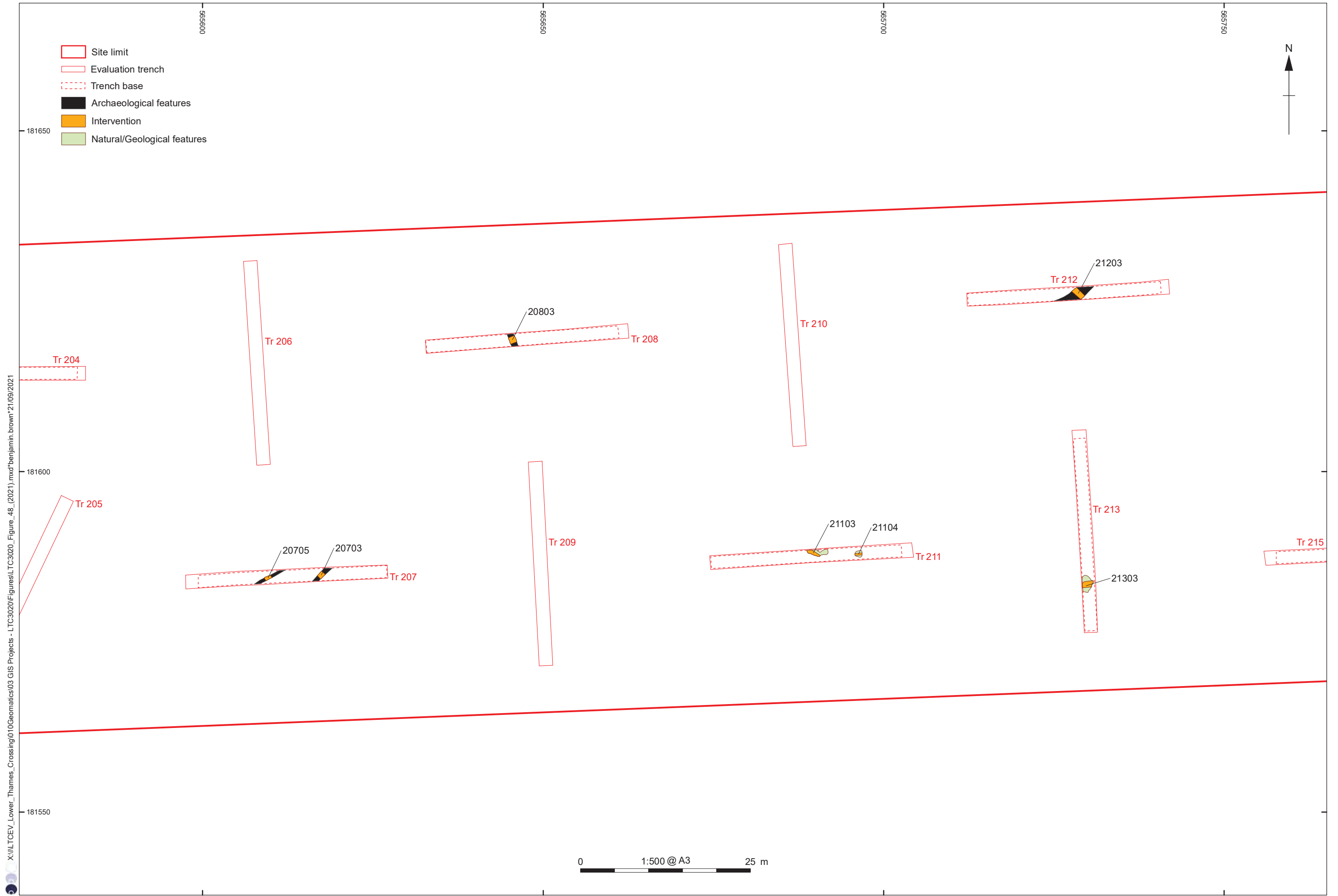

X:\ILTCEV\_Lower\_Thames\_Crossing\010\Geomatics\03 GIS Projects - LTC3020\Figures\TC3020\_Figure\_48\_(2021).mxd\benjamin.brown\*21/09/2021

Contains Ordnance Survey data © Crown copyright and database right 2020, provided by client

Figure 48: Detailed plan of Trenches 207-8 and 212

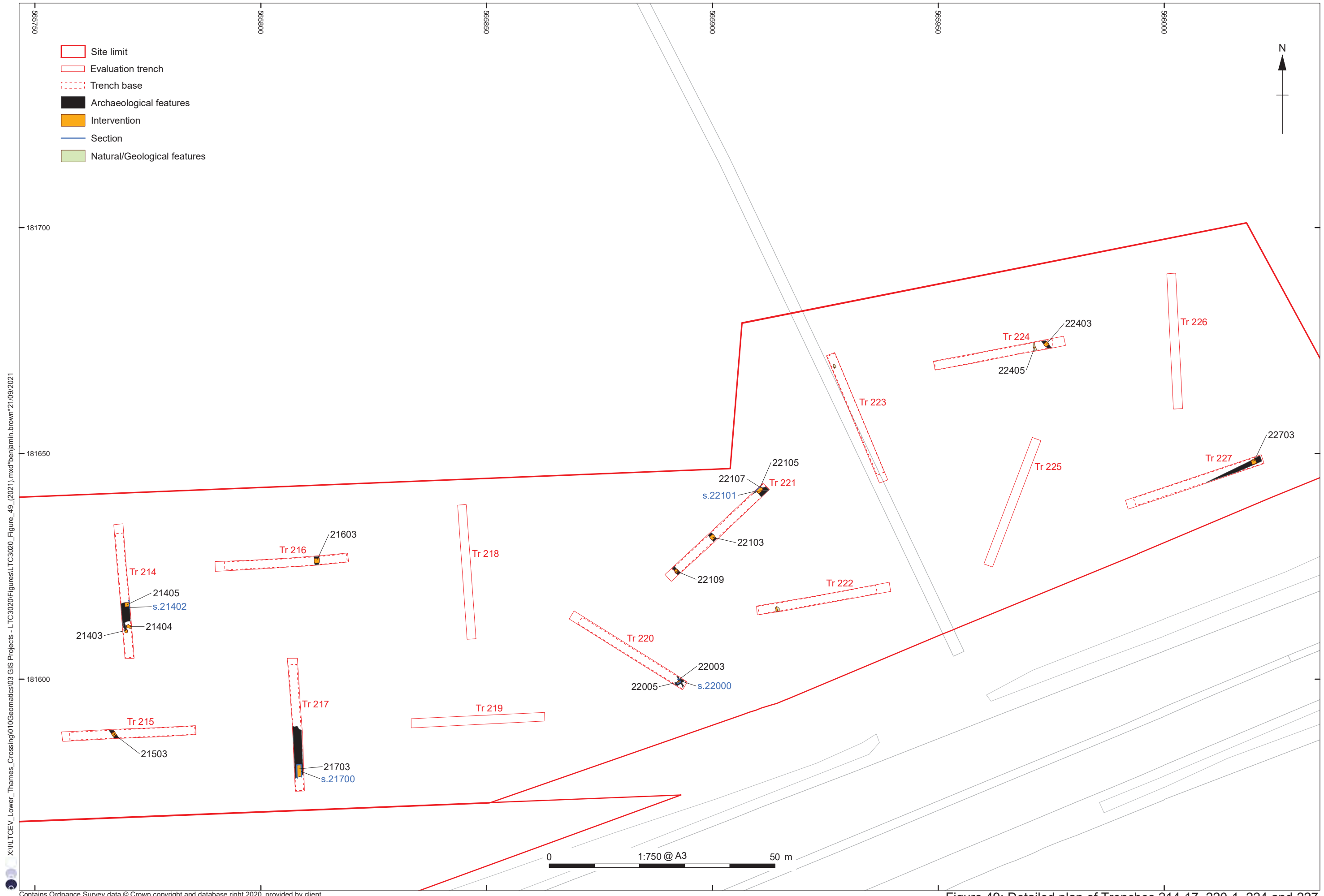

X:\ILTCEV\_Lower\_Thames\_Crossing\010Geomatics\03 GIS Projects - LTC3020\Figures\TC3020\_Figure\_49\_(2021).mxd\benjamin.brown\*21/09/2021

Contains Ordnance Survey data © Crown copyright and database right 2020, provided by client

Figure 49: Detailed plan of Trenches 214-17, 220-1, 224 and 227

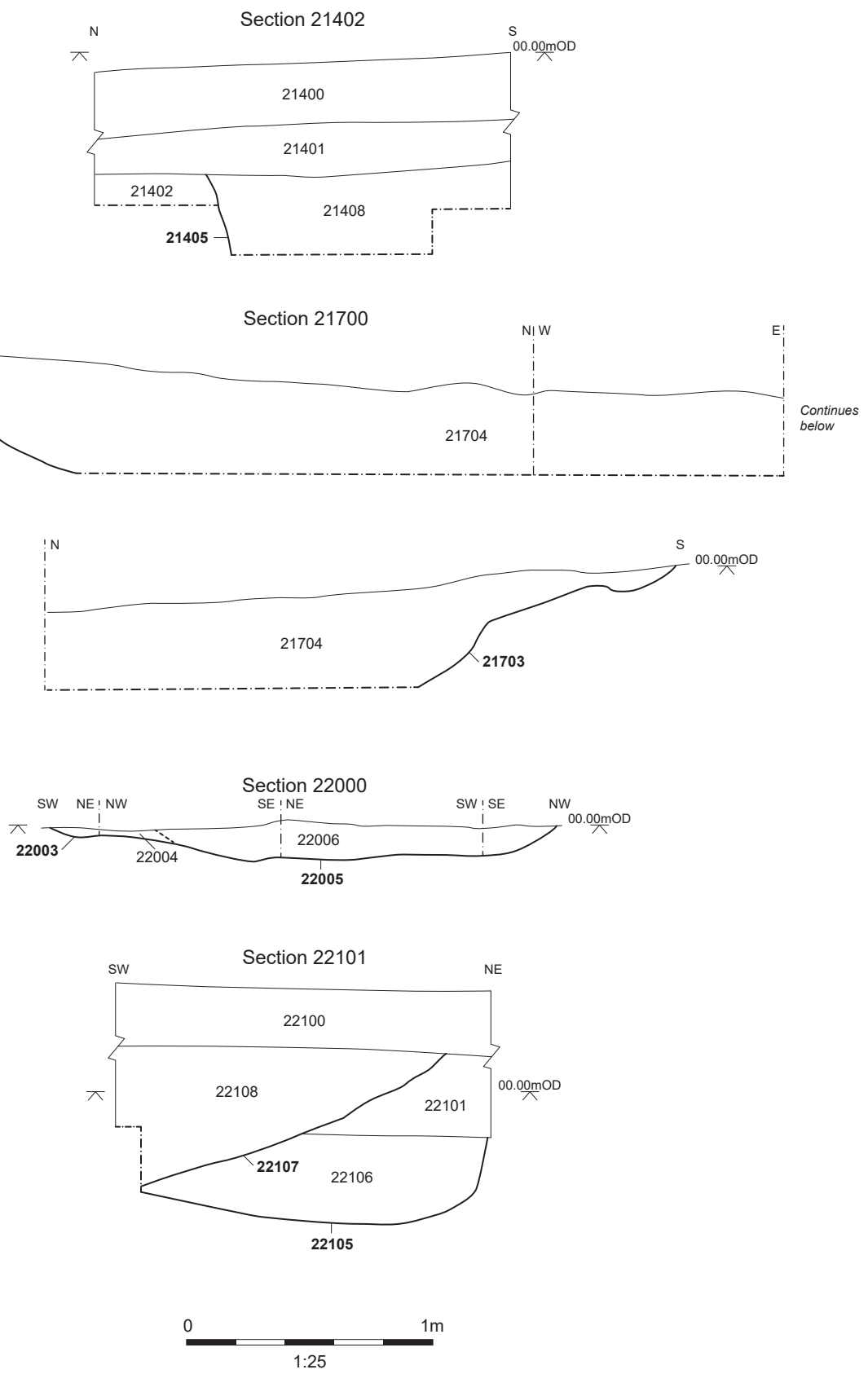
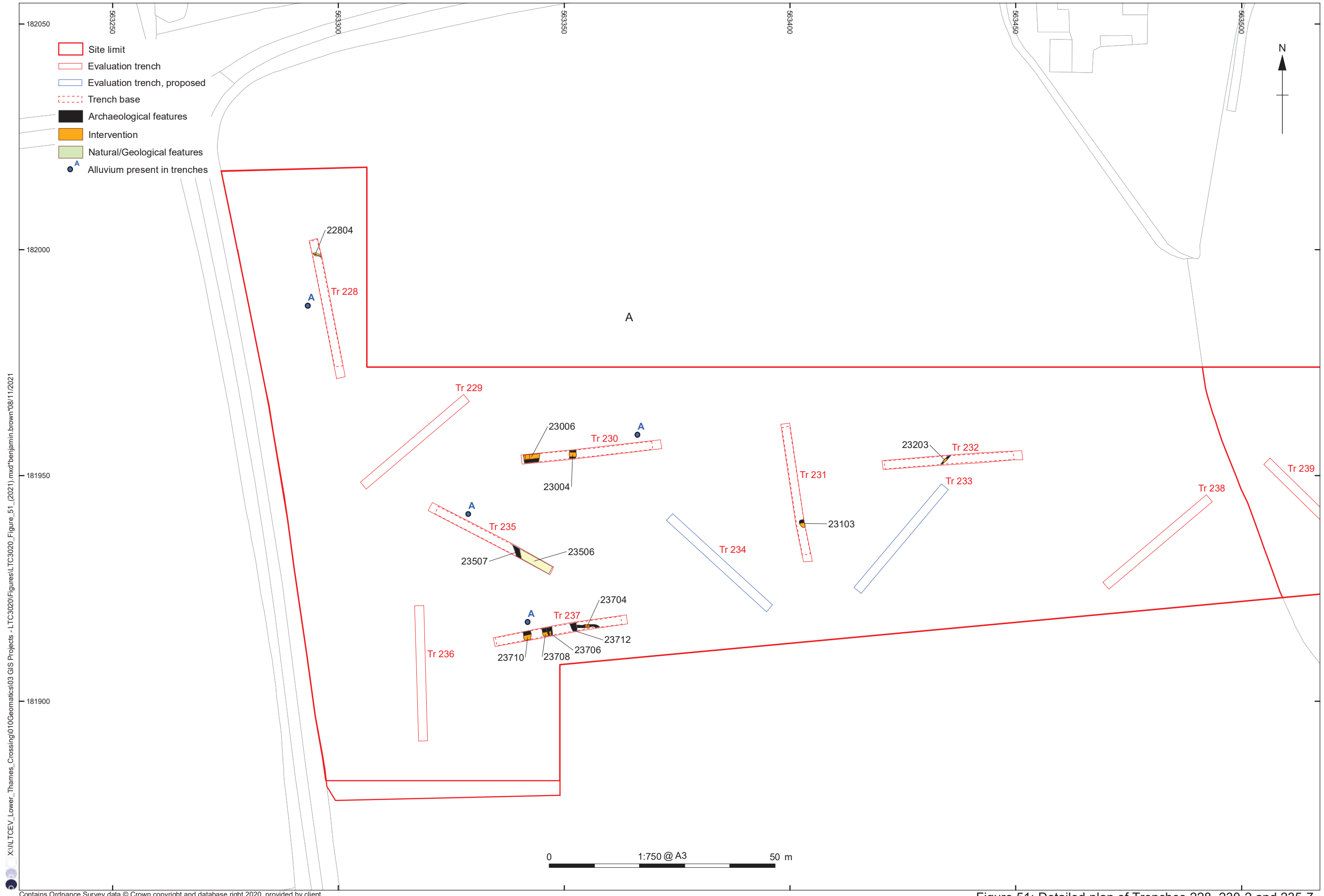

Figure 50: Sections, Trenches 214, 217 and 220-1



X:\ILTCEV\_Lower\_Thames\_Crossing\010Geomatics\03 GIS Projects - LTC3020\Figures\TC3020\_Figure\_51\_(2021).mxd\benjamin.brown\08/11/2021

Contains Ordnance Survey data © Crown copyright and database right 2020, provided by client

Figure 51: Detailed plan of Trenches 228, 230-2 and 235-7

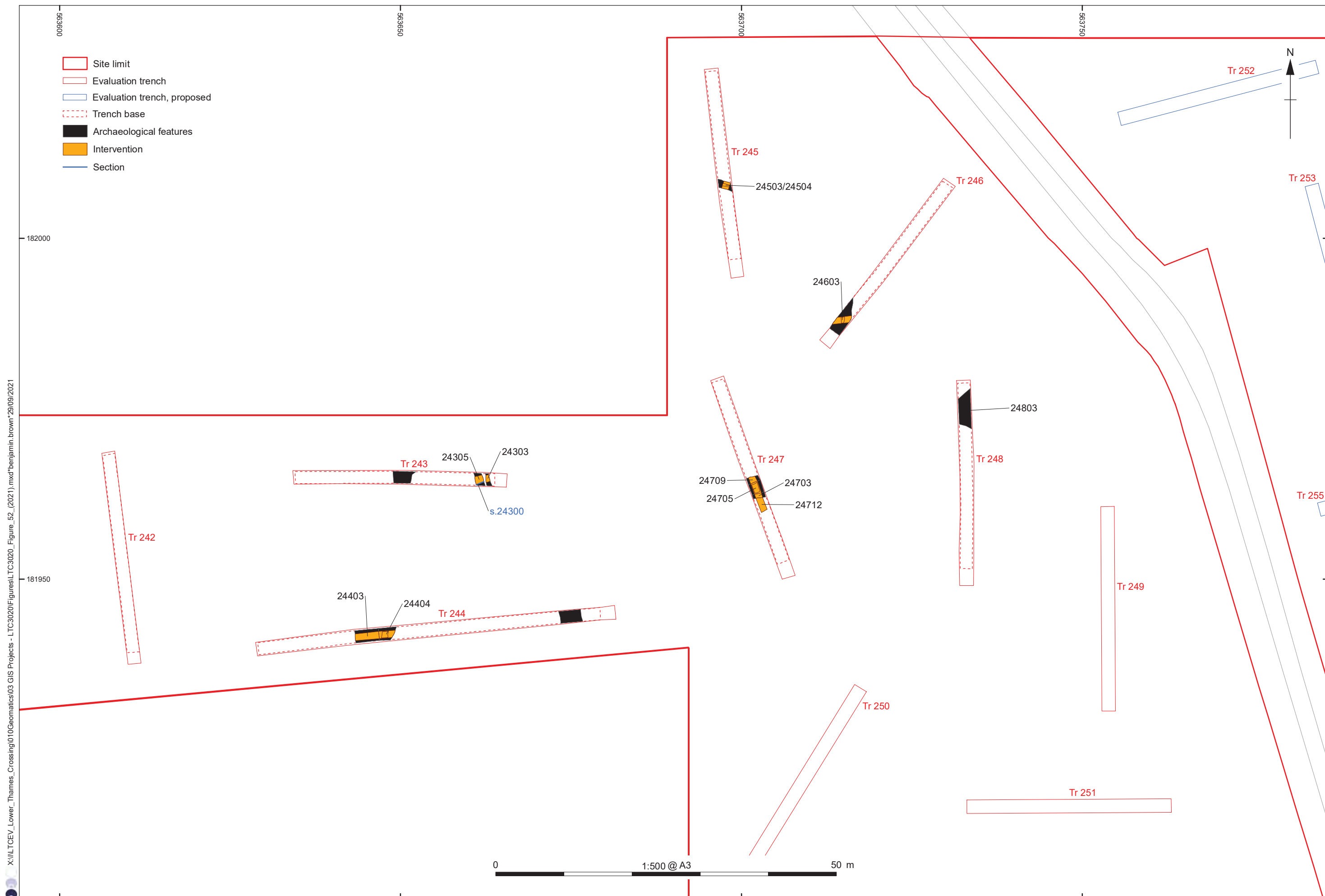

X:\ILTCEV\_Lower\_Thames\_Crossing\010Geomatics\03 GIS Projects - LTC3020\Figures\TC3020\_Figure\_52\_(2021).mxd\benjamin.brown\*29/09/2021

Contains Ordnance Survey data © Crown copyright and database right 2020, provided by client

Figure 52: Detailed plan of Trenches 243-8

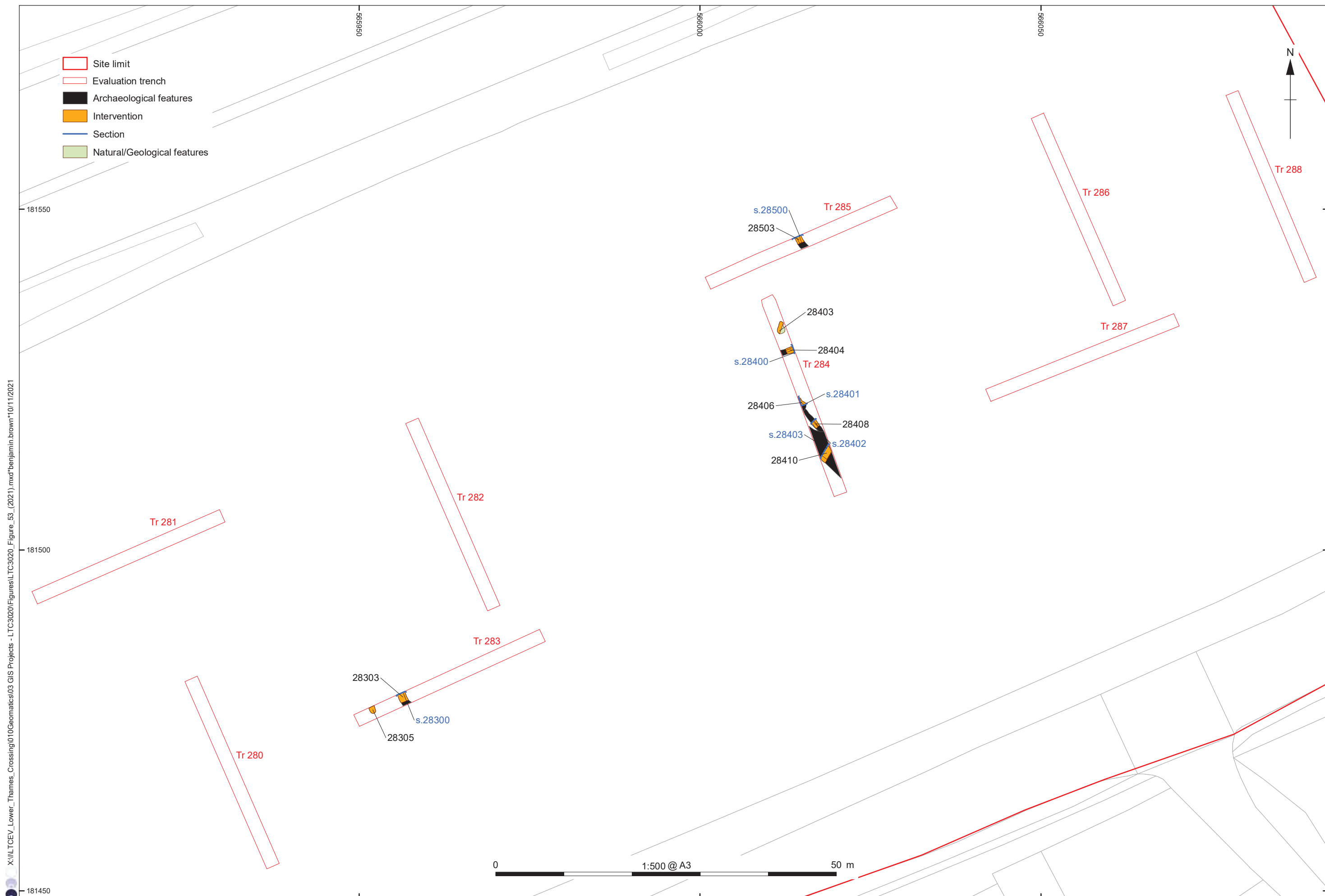

X:\ILTCEV\_Lower\_Thames\_Crossing\010\Geomatics\03 GIS Projects - LTC3020\Figures\TC3020\_Figure\_53\_(2021).mxd\benjamin.brown\10/11/2021

Contains Ordnance Survey data © Crown copyright and database right 2020, provided by client

Figure 53: Detailed plan of Trenches 283-5

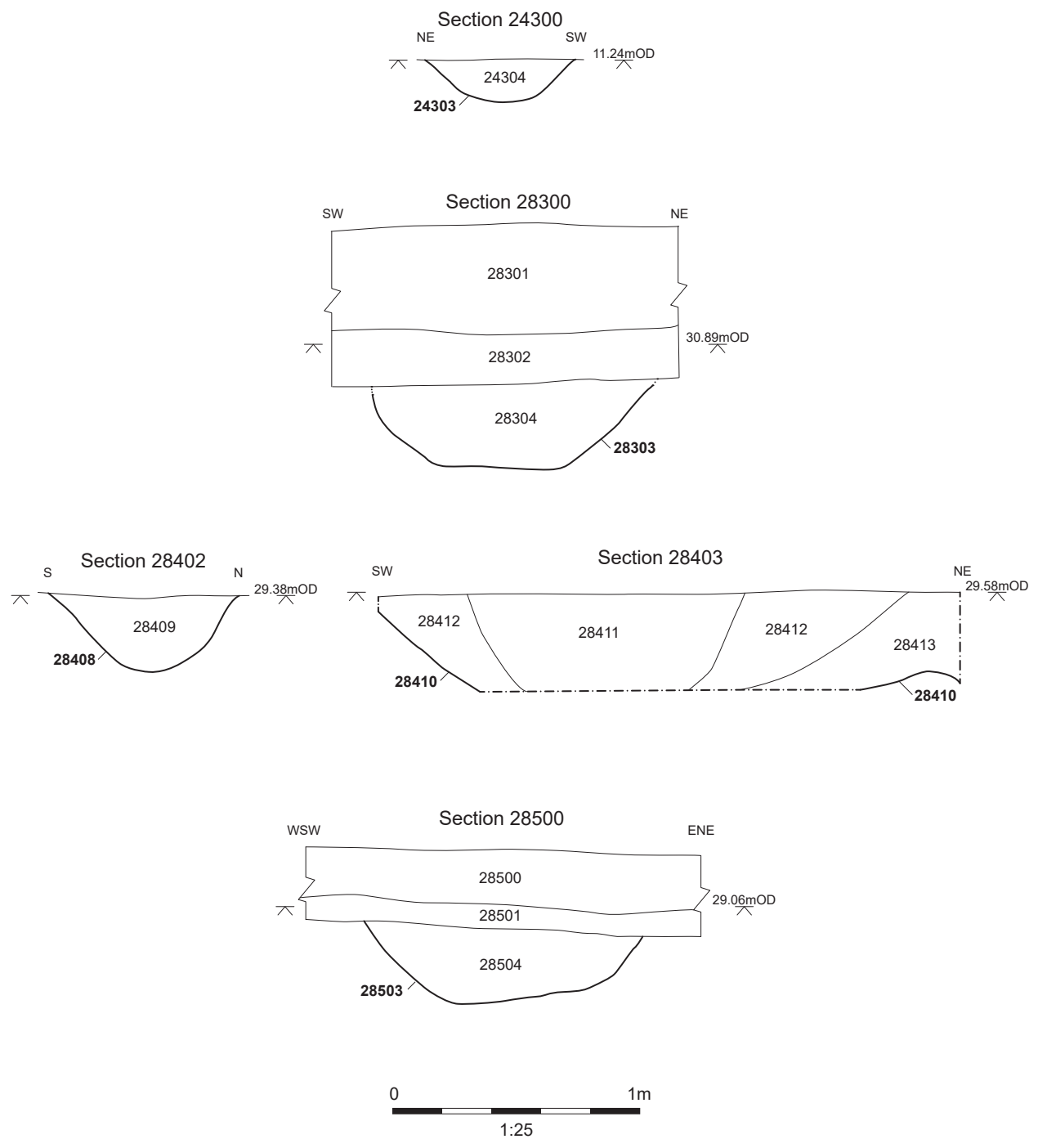
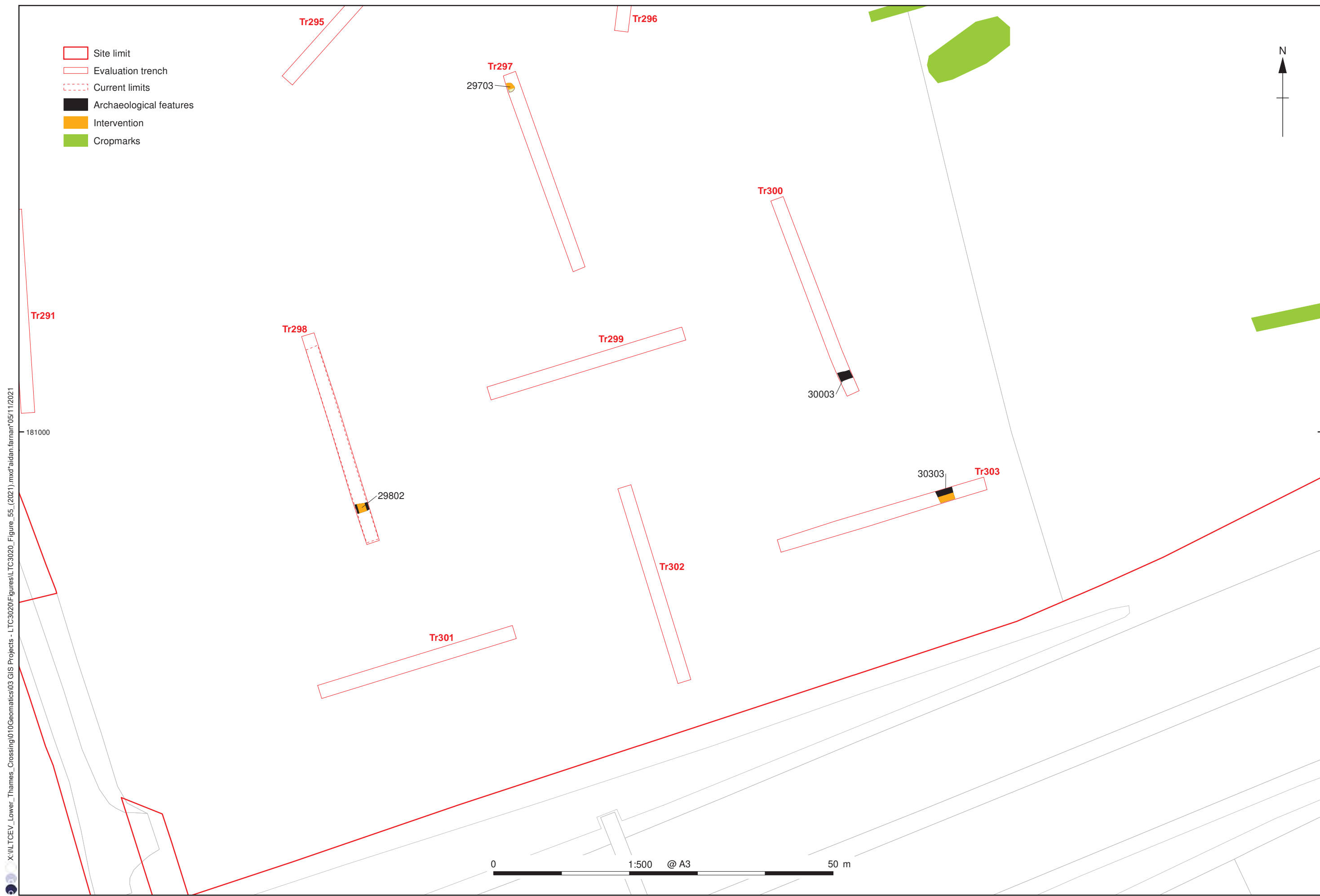

Figure 54: Sections, Trenches 243 and 283-5





X:\ILTCEV\_Lower\_Thames\_Crossing\010\Geomatics\03 GIS Projects - LTC3020\Figures\TC3020\_Figure\_55\_(2021).mxd\aidan.farnan\05/11/2021

Contains Ordnance Survey data © Crown copyright and database right 2020, provided by client

Figure 55: Detailed plan of Trenches 297-8, 300 and 303



Plate 1: Trench 148, looking east



Plate 2: Ditch 15002, looking south-east



Plate 3: Section 14100 through ditches in Trench 141, looking south



Plate 4: Ditch 14309, looking west



Plate 5: Ditch 14002, looking north-east



Plate 6: Cremation 13610, looking north-west



Plate 7: Ditch 13502, looking north-east

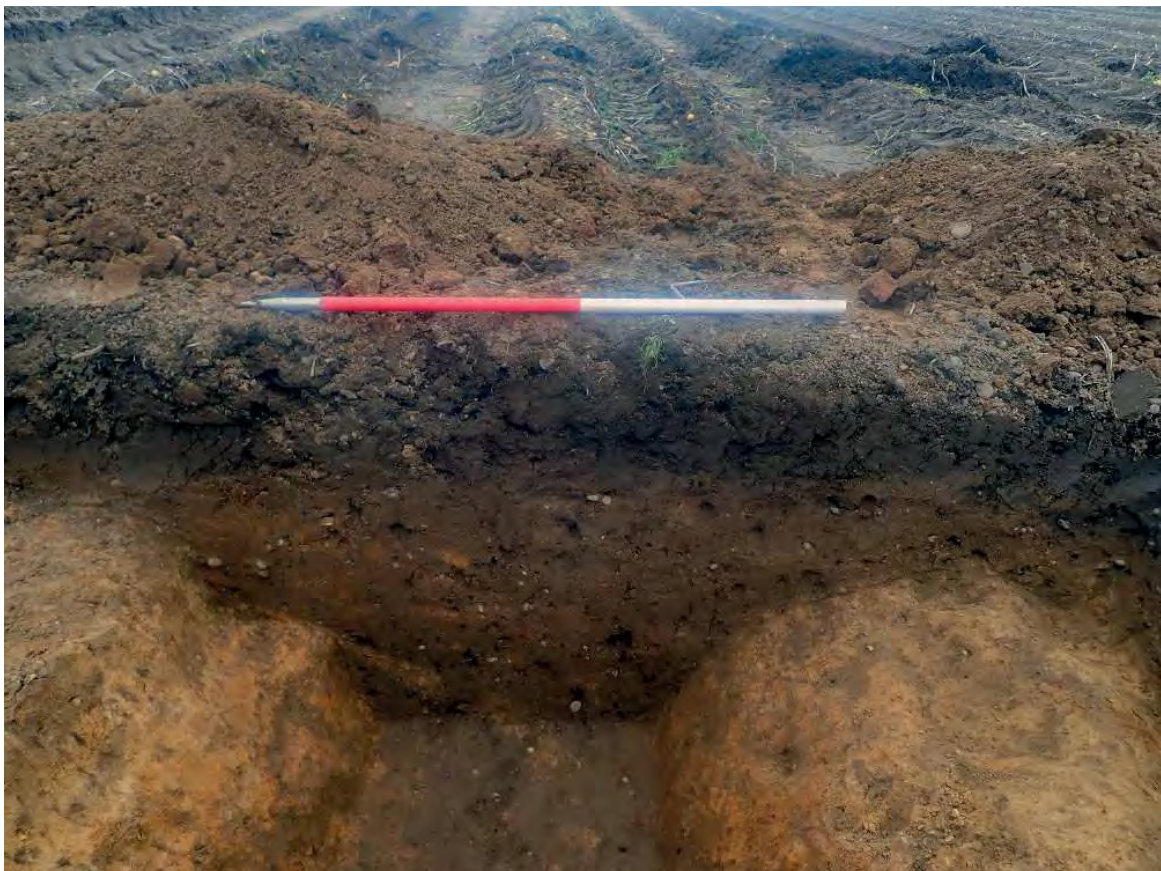

Plate 8: Ditch 18606, looking west



Plate 9: Posthole 4313, looking east



Plate 10: Pit 7603, looking east



Plate 11: Ditches or pits 9804 and 9806, looking south-west



Plate 12: Ditch 8406, looking south



Plate 13: Pit 10404, looking north-west



Plate 14: Pottery dump in pit 10404





Plate 15: Ditches 11104 and 11106, looking north



Plate 16: Postholes 103, 105 and 107, looking north-west



Plate 17: Pit or posthole 703, looking east



Plate 18: Ditch 3105, looking north



Plate 19: Ditch 23004, looking north



Plate 20: Pit 23103, looking north-west



Plate 21: Ditch 23203, looking east



Plate 22: Alluvial layer 23506 in section, looking south-west



Plate 23: Ditch 27310, looking south

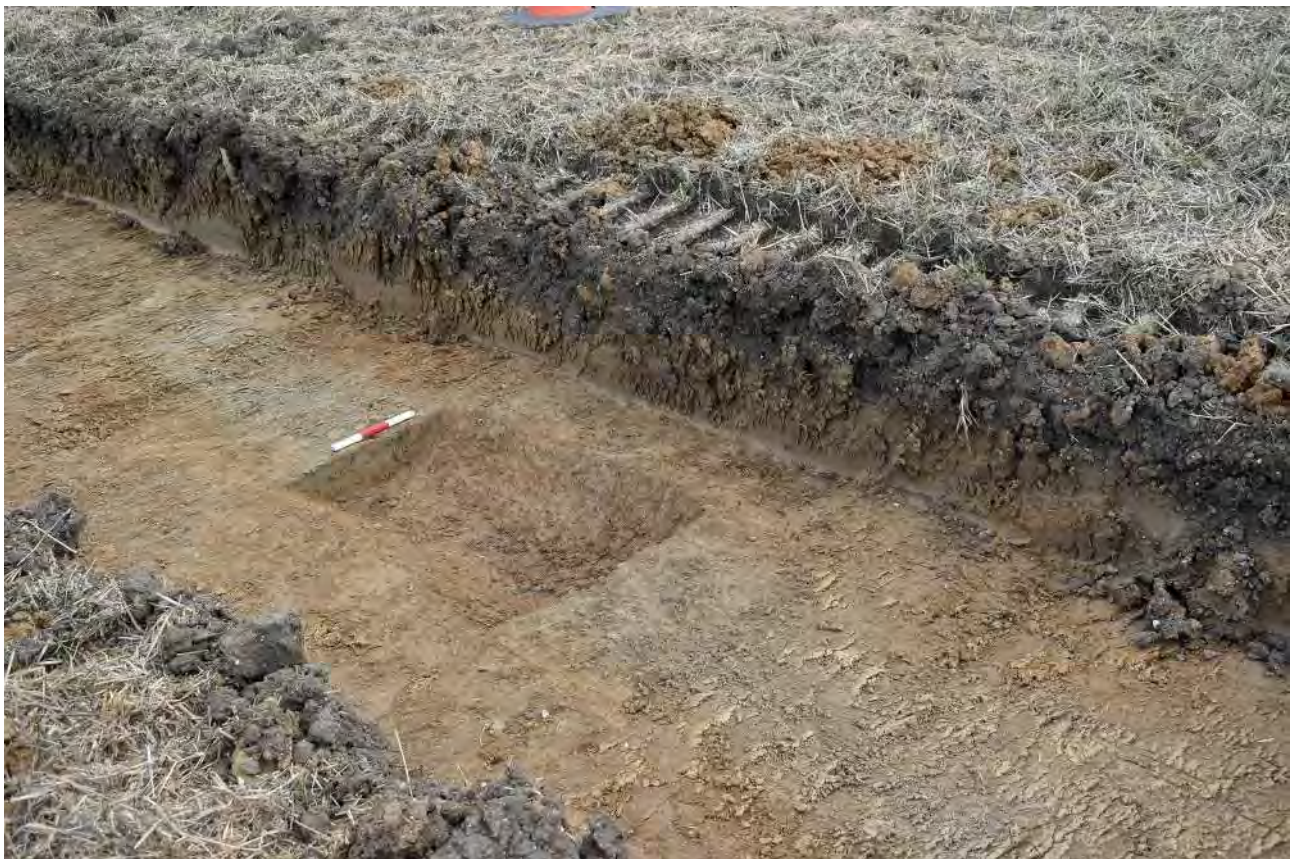

Plate 24: Ditch 23704, looking north-west



Plate 25: Ditch 24303, looking south



Plate 26: Ditch 24305, looking south



Plate 27: Ditches 24403 and 24404, looking north-west



Plate 28: Ditch 24503, looking north-west



Plate 29: Ditch 24603, looking north







## COVER SHEET

|                      |   |
|----------------------|---|
| <b>Title:</b>        | <b>Archaeological Evaluation Report for Trial Trenching of Land Parcel 37</b> |
| <b>Project Name:</b> | <b>Lower Thames Crossing Enabling Works</b>                                   |
| <b>Ref No:</b>       | <b>HE540039-BAL-GEN-GEN-REP-HER-00033</b>                                     |
| <b>Revision No:</b>  | <b>P01</b>  |
| <b>Review Date:</b>  | <b>14/01/2020</b>   |
| <b>Status:</b>       | <b>S2 – Information</b>   |
| <b>No. of Pages</b>  | <b>123</b>  |

| Rev | Date of Issue | Revision Status    | Originator | Checker       | Approver      |
|-----|---------------|--------------------|------------|---------------|---------------|
| P01 | 14/01/2021    | S2 For Information | Sam Ashton | Jack Fletcher | Emily Erswell |
|     |               |                    |            |               |               |
|     |               |                    |            |               |               |
|     |               |                    |            |               |               |



# Lower Thames Crossing

Archaeological Evaluation Report for Trial Trenching of  
Land Parcel 37, Land at East Tilbury, Essex

Document Number: HE540039-BAL-GEN-GEN-REP-HER-00033

January 2021

---

LOWER THAMES CROSSING ARCHAEOLOGICAL EVALUATION REPORT LAND PARCEL 37 EAST TILBURY  
LTC15TEV\_EVALUATION\_REPORT\_V1\_1\_FINAL\_SL\_000121  
DATE PUBLISHED - 02/07/2021  
UNCONTROLLED WHEN PRINTED - COPYRIGHT © - 2020 - HIGHWAYS ENGLAND COMPANY LIMITED - ALL RIGHTS RESERVED

1



| Revision | Production Date  | Prepared by   | Checked by   | Approved for release by | Sections revised |
|----------|------------------|---|--|-------------------------|------------------|
| 1.0      | 5th January 2021 | Mark Dodd,<br>Project Officer<br>Oxford Archaeology | Tim Allen,<br>Senior Project Manager,<br>Oxford Archaeology      | Internal review only    |                  |
| 1.1      | 8th January 2021 | Mark Dodd,<br>Project Officer<br>Oxford Archaeology | Steve Lawrence,<br>Senior Project Manager,<br>Oxford Archaeology |                         |                  |
|          |                  |   |  |                         |                  |

This Evaluation Report has been prepared for Highways England in accordance with the terms and conditions of appointment stated in the Lower Thames Crossing (LTC) Technical Partner Contract. LTC cannot accept any responsibility for any use of or reliance on the contents of this document by any third party.

# Contents

| Section  | Page      |
|--|-----------|
| <b>Summary</b> .....   | <b>6</b>  |
| <b>Acknowledgements</b> .....  | <b>7</b>  |
| <b>1 Introduction</b> .....  | <b>8</b>  |
| 1.1 Project details and scope of work .....                                | 8         |
| 1.2 Location, topography and geology .....                                 | 9         |
| 1.3 Previous investigations .....  | 9         |
| 1.4 Archaeological and historical background .....                         | 9         |
| <b>2 Project Aims</b> .....  | <b>13</b> |
| 2.1 General aims .....   | 13        |
| 2.2 Specific objectives .....  | 14        |
| <b>3 Methodology</b> .....   | <b>16</b> |
| 3.1 Constraints .....  | 16        |
| 3.2 Methodology for the evaluation .....                                   | 16        |
| <b>4 Results</b> .....   | <b>17</b> |
| 4.1 Introduction and presentation of results .....                         | 17        |
| 4.2 General soils and ground conditions .....                              | 17        |
| 4.3 General distribution of archaeological deposits .....                  | 17        |
| 4.4 Trenches 17, 27 and 28 (Figs. 3, 4 and 5) .....                        | 18        |
| 4.5 Trenches 38, 29, 18, 16, 26, 12 and 13 (Figs. 6, 7, 8, 9 and 10) ..... | 21        |
| 4.6 Trenches 1, 2, 6, 7, 8, 9 and 11 (Figs. 11, 12 and 13) .....           | 25        |
| 4.7 Trenches 15, 19, 25, 31 and 21 (Figs. 14, 15 and 16) .....             | 28        |
| 4.8 Trenches 34, 35, 42 and 37 (Figs. 17 and 18) .....                     | 29        |
| 4.9 Finds summary .....  | 30        |
| 4.10 Environmental summary .....   | 31        |
| <b>5 Discussion</b> .....  | <b>32</b> |
| 5.1 Reliability of field investigation .....                               | 32        |
| 5.2 Interpretation .....   | 33        |
| 5.3 Evaluation objectives and results .....                                | 36        |
| <b>Appendix A Trench Tables</b> .....                                      | <b>39</b> |
| <b>Appendix B Finds Reports</b> .....                                      | <b>65</b> |
| <b>Appendix C Environmental Reports</b> .....                              | <b>85</b> |
| <b>Appendix D References</b> .....   | <b>91</b> |
| <b>Appendix E Abbreviations and Glossary</b> .....                         | <b>94</b> |
| <b>Appendix F Site Summary</b> .....                                       | <b>95</b> |

## Figures

- Figure 1: Location of Land Parcel 37
- Figure 2: Plan of trench layouts, archaeological features and cropmark data
- Figure 3: Detailed plan of Trenches 17, 27 and 28
- Figure 4: Sections (Trenches 17 and 27)
- Figure 5: Sections (Trench 28)
- Figure 6: Detailed plan of Trenches 12, 13, 16, 18, 26, 29, and 38
- Figure 7: Sections (Trenches 38, 29, 12 and 13)
- Figure 8: Section (Trench 13)
- Figure 9: Sections (Trenches 16 and 18)
- Figure 10: Sections (Trenches 18 and 26)
- Figure 11: Detailed plan of Trenches 1, 2, 6, 7, 8, 9 and 11
- Figure 12: Sections (Trenches 1, 2, 6, 7 and 8)
- Figure 13: Sections (Trenches 9 and 11)
- Figure 14: Detailed plan of Trenches 15, 19, 21, 25 and 31
- Figure 15: Sections (Trenches 15, 21, 25 and 31)
- Figure 16: Sections (Trench 31)
- Figure 17: Detailed plan of Trenches 34, 35, 37 and 42
- Figure 18: Sections (Trenches 34, 35, 37 and 42)
- Figure 19: Condition of animal bone specimens (Appendix C.2)

## Plates

- Plate 1: Pit 1704 (view to south-east)
- Plate 2: Pits 1707 and 1709 (view to west)
- Plate 3: Pits 2710 and 2712 (view to south-west)
- Plate 4: Posthole 2714 (view to south)
- Plate 5: Trench 28 (view to south)
- Plate 6: Working shot of Trench 28 (view to north)
- Plate 7: Pit 2807 (view to south)
- Plate 8: Ditches 2905 and 2907 (view to south-west)

- Plate 9: Ditches 1804, 1806 and 1808 (view to north-east)
- Plate 10: Ditch 1605 (view to north-east)
- Plate 11: Unexcavated pit 1210 (view to north-east)
- Plate 12: Ditches 1304 and 1306 (view to south-east)
- Plate 13: Pit 109 and ditches 120 and 102 (view to south-west)
- Plate 14: Pit 1504 (view to south-east)
- Plate 15: Ditch 2502 (view to north-west)

## Tables

- Table 1: Prehistoric pottery
- Table 2: Quantification of the late Iron Age and Roman pottery by context
- Table 3: Description of post-Roman pottery by context
- Table 4: Flints by context
- Table 5: Summary of briquetage, fired clay and CBM assemblage
- Table 6: Summary of CBM forms
- Table 7: Description of metalwork by context
- Table 8: Details of worked stone
- Table 9: Assessment of bulk (CPR) samples
- Table 10: Number of specimens (NSP) by period
- Table 11: Total number of specimens and weight of specimens from each context.

## Summary

---

Oxford Cotswold Archaeology was commissioned by Balfour Beatty to undertake a trial trench evaluation of Land Parcels 15, 16, 17 and 37 covered by WSI J of the Lower Thames Crossing Pre-Enabling Works. Due to the limited impact anticipated in Land Parcels 15-17, it was subsequently agreed with the Key Archaeological Stakeholders that these need not be evaluated. Land Parcel 37 lies between West Tilbury and East Tilbury south-west of Station Road, within the county of Essex and Thurrock unitary authority (centred on NGR 567300 177350). A total of 42 trenches representing a 5% sample were excavated and recorded between 21st September and 8th October 2020.

The trenches revealed a dense concentration of archaeological features on the plateau running along the south-east edge of the site. The remains comprised pits and postholes demarcated by linear and curvilinear boundary ditches. The earliest activity was a middle Neolithic pit, but the main phase of occupation belongs to the late Bronze Age and/or early Iron Age. Evidence for middle Iron Age activity was equivocal, but there was further settlement in the late Iron Age and early Roman periods. The prehistoric activity included widespread evidence of salt-working in the form both of features with purplish stains, and briquetage, and the pottery of the early Roman period included regional and continental imports, suggesting that the site was both Romanised and of reasonable status.

The scale of activity contracted in the middle Roman period, and evidence for late Roman activity was limited to a single sherd of pottery. The last significant phase of activity was the early and middle Saxon period (AD 400-750), consisting of pits, postholes and several large shallow features (only partially exposed) that may be sunken-featured buildings indicating permanent settlement. Anglo-Saxon activity was more widely spread than the earlier activity on the high ground. Medieval activity was limited to a few sherds of pottery from ditches and a pit in the north-east corner of the site, and it is unclear whether these features were medieval or later.

Some of the exposed ditches matched the alignment and were close to the line of field boundaries on historic maps, and most other ditches, including the cropmark boundaries, ran either on or at right angles to these alignments, suggesting that the site was divided into smaller land parcels in the past, originating either in the medieval or post-medieval period.

## Acknowledgements

---

Oxford Cotswold Archaeology would like to thank the client, Balfour Beatty, for commissioning this project and managing the site safety and attendances. Thanks, are also extended to the Historic Environment Consultants (Richard Havis and Katie Lee-Smith) of Place Services at Essex County Council, who advise the Borough of Thurrock, for monitoring and providing advice throughout the project.

The project was managed for Oxford Cotswold Archaeology by Steve Lawrence. The fieldwork was directed day-to-day by Mark Dodd, and work in Land Parcel 37 was supervised by Eilidh Barr and Jonathan Orellana, who were supported by Jacopo Gelmi, Rachel Alexander, Melanie Sayer, Chris Griffiths, Kerree Kendall, Stephen Foster, Ellie Brown, Ben Camp, Megan Mangum and Alex Capon. Site survey was undertaken by Caroline Souday and Jessica Domiczew and digitising was carried out by Caroline Souday and Sophie Lamb.

Thanks, are also extended to the teams of OA staff that cleaned and packaged the finds under the management of Leigh Allen and Geraldine Crann, processed the environmental remains under the management of Rebecca Nicholson, and prepared the archive under the management of Nicola Scott.



# 1 Introduction

## 1.1 Project details and scope of work

- 1.1.1 The Lower Thames Crossing Project is located between the A2 in Kent and the M25 in the London Borough of Havering. It will run underneath the River Thames through a tunnel and emerge on the northern side of the river at East Tilbury. From the North Portal the road will run to the M25 at Junction 29 via the A13 and pass between North and South Ockendon. The development of the project is managed by LTC, a partnership between Highways England and a consultancy joint venture set up to oversee the scheme.
- 1.1.2 A programme of archaeological trial trenching commenced in the Essex part of the scheme in November 2019. A scheme-wide specification for trial trenching was written by LTC (Highways England 2018), and in July 2019, LTC commissioned Balfour Beatty to deliver the pre-Enabling Works. Balfour Beatty appointed Oxford Archaeology (OA) to prepare a project-wide written scheme of investigation (WSI) for the scheme, which (at the request of the key archaeological stakeholders) is divided into two parts, one for the Kent section, and another for Essex and Havering (Oxford Archaeology 2019a; 2019b).
- 1.1.3 Following completion of the project-wide WSIs, OA was instructed to prepare a series of site-specific or group-site specific WSIs for approval by the key archaeological stakeholders in advance of trial trenching to inform the Development Consent Order (DCO). A detailed WSI was created for Land Parcels 15, 16, 17 and 37 prior to the trial trenching (WSI J, Oxford Archaeology 2020), which details the archaeological background and potential of the site. It also sets out the archaeological aims and objectives appropriate to the investigation of this land parcel by trenching and describes the methodology to be applied. The WSI was approved by Richard Havis, Principal Historic Environment Consultant for Place Services at Essex County Council, prior to the start of the fieldwork.
- 1.1.4 Oxford Cotswold Archaeology was commissioned as Balfour Beatty's archaeological contractor to undertake the evaluation in accordance with the approved WSI and local and national planning policies. Due to the minimal impact anticipated in Land Parcels 15-17, which involve only ecological mitigation measures, and with the agreement with Richard Havis of Place Services, these land parcels were subsequently removed from the scope of trial trenching, so that only Land Parcel 37 remained in need of trial trenching.
- 1.1.5 The fieldwork in Land Parcel 37 was completed between 21st September and 8th October 2020. All work followed the MoRPHE Project Manager's guide (Historic England 2015), and the Code of Conduct of the Chartered Institute for Archaeologists (CIfA). The archaeological works adhered to the standards and guidance for archaeological evaluation, excavation and archiving (CIfA 2014a; CIfA 2014b).

- 1.1.6 The work was monitored by Richard Havis and Katie Lee-Smith of Place Services on behalf of the Borough of Thurrock.

## 1.2 Location, topography and geology

- 1.2.1 Land Parcel 37 is located between West Tilbury and East Tilbury, south-west of Station Road. It occupies a small promontory at the western end of a plateau which overlooks the tidal floodplain to the south. The south-east edge of the site is relatively flat and occupies the highest ground within the parcel, c 12m aOD. The site drops away moderately steeply to the north-west, along a break of slope that bisects the site on a SW-NE orientation. The south-west edge of the site is very steeply sloped, descending to the lowest part of the site just 2m aOD.
- 1.2.2 The bedrock geology of the site is mapped as Thanet Sand, with a combination of Head deposits occupying the sloped areas of the site and the higher plateau formed from Lynch Hill gravel (BGS 2020).

## 1.3 Previous investigations

- 1.3.1 No known previous investigations have taken place within Land Parcel 37.

## 1.4 Archaeological and historical background

- 1.4.1 The chronological summary of known archaeology given below is taken from the detailed WSI for Land Parcels 15-17 and 37.
- 1.4.2 **Palaeolithic.** No Palaeolithic finds have been recovered within the site. One Palaeolithic find has been recorded near the site and just north of East Tilbury Church. This was an Acheulian hand-axe located c 50m south of Land Parcel 16.
- 1.4.3 **Mesolithic.** No Mesolithic finds have been recorded within the site or within 1km of the site.
- 1.4.4 **Neolithic.** A possible Neolithic burial was recorded at East Tilbury in 1982 just south of Land Parcel 15. There is little information with this entry in the historic environment record (HER) apart from that the finds were gifted to Passmore Edwards Museum which has now closed. Another possible Neolithic burial was found within Land Parcel 16 in 1892.
- 1.4.5 A Neolithic flint axe or chisel was dredged from the Thames off Tilbury. The grid reference for this in the HER is just north of Coalhouse Fort but the exact location of the find in the Thames is unknown.
- 1.4.6 Another Neolithic find, a flint arrowhead was recorded c 400m south-west of Land Parcel 37.
- 1.4.7 **Bronze Age.** Worked flints were found within Land Parcel 17 of the site and these were dated to the Neolithic to Bronze Age. The HER has limited information on these objects but they are stored in Thurrock Museum. The cropmarks of two possible ring ditches are located c 20m and 300m north of Land Parcel 15. These were recorded by the aerial survey and may represent ploughed-out round barrows (Aerial Investigations and Mapping Report site 45). These ring ditches are located on the north slopes of a plateau of higher ground overlooking a lower estuarine area to the north.

- 1.4.8 A perforated whetstone of probable Bronze Age date was found just south of Land Parcel 15. Another whetstone of probable Bronze Age date was also found within the western part of Land Parcel 16. This second whetstone is stored in Colchester Museum.
- 1.4.9 In 2014 a late Neolithic/early Bronze Age enclosure was excavated 0.7km north-east of Land Parcel 16. A single cremation was found within this sub-rectangular enclosure, which was radiocarbon-dated to 1741-1535 cal. BC.
- 1.4.10 In 2005 an archaeological evaluation recorded evidence of an enclosed Bronze Age settlement and a late Bronze Age field system 0.7km north-west of Land Parcel 16. Flints found along a gas pipeline further south, suggest that prehistoric activity continues all along the gravel terrace to the south-east, though whether the activity is Bronze Age or earlier is not clear.
- 1.4.11 **Iron Age.** During the late 1960s a salvage excavation was undertaken west of Princess Margaret Road and west of Land Parcel 16. This excavation recorded a sub-rectangular enclosure with a ditch 1.5m wide by 0.76m deep and a number of associated pits. The pottery was dated to the Iron Age and charcoal and animal bones were also found. Cropmarks of a U-shaped enclosure were also recorded just west of this. A further cropmark site was located 300m north of this rectilinear enclosure and both cropmark sites may also represent Iron Age activity.
- 1.4.12 There is a group of cropmarks within Land Parcel 37 and just north of Land Parcel 15 which may indicate the presence of later prehistoric settlement activity (Aerial Mapping Report sites 44 and 45). Other than the ring ditches mentioned above, this consists mainly of a series of ditches, some of which form right angles, together with occasional discrete features, including one possible very small enclosure. It is possible that these features could date to the Iron Age as the 1960s excavation of the sub-rectangular enclosure was located just north of the cropmarks recorded by the aerial survey just north of Land Parcel 15. In addition, a number of Iron Age findspots have been recorded in the vicinity including Iron Age pottery recovered just east of Princess Margaret Road and within Land Parcel 16 and two Iron Age findspots just to the east. The finds included fired clay (perhaps briquetage) together with Iron Age and Roman pottery, so there may have been a prehistoric saltern in the vicinity. In 1959 pottery sherds dating to the 1st century BC were found during repairs to the sea wall. Iron Age pottery was also recorded just south of Land Parcel 15.
- 1.4.13 **Roman.** The route of a Roman road is thought to have been located along what is now Princess Margaret Road and adjacent to Land Parcels 15 and 16 of the site. There is no physical evidence for the road itself, but it may have led to a ferry crossing point over the River Thames to Kent. This is supported by archaeological evidence which suggests there was a Roman settlement close to the foreshore. This includes evidence for a Roman mosaic, ceramic building material, undated human remains and Roman finds. This settlement may have been established at a crossing point over the Thames. Another Roman settlement along the Orsett to East Tilbury Roman road was located at Mucking, c 2km north-east of the site (Lucy and Evans 2016). Remains relating to a Roman field system have been

excavated 0.7km north-west of the site along the route of the East Tilbury road which linked the settlements of Mucking and East Tilbury.

- 1.4.14 In 1959 during repairs to the sea wall, c 300m east of the site, Roman pottery dating to the 4th century was found with pottery sherds dating to the 1st century B.C. In this area large areas of black, burnt material and some ditch formations stretching for about 0.7km along the foreshore were observed. This may be the site of an Iron Age and Roman saltern. A nearby geophysical survey in 2014 revealed another possible saltern (located just east of Land Parcel 17) and another undated saltern was located further east. Two other salterns were located 0.4km south of Land Parcel 37. Roman finds have also been recorded nearby along the Thames foreshore.
- 1.4.15 A Romano British pottery kiln, Roman burials with bronze and iron bracelets and Roman finds were recorded at Condovers Pit, located 0.7km west of Land Parcel 37.
- 1.4.16 **Medieval.** At least 20 Saxon sceattas have been found across an arable field just west of the East Tilbury church and c 100m south of Land Parcel 15. This is suggestive of a middle Saxon settlement or religious site at this location.
- 1.4.17 Otherwise, there is no evidence of early to mid-Saxon activity within the site or vicinity.
- 1.4.18 The potential for early medieval archaeology within the site must therefore be considered to be moderate. Princess Margaret Road is likely to have been established in the Roman period but was almost certainly in place by the later medieval period as it led to the East Tilbury ferry. There may have been medieval farmsteads and settlements located along this road and within Land Parcels 15, 16 and 17.
- 1.4.19 The medieval hospital of St Mary may have been located within or close to Land Parcel 15 or 16. Human bone has been found in a field west of East Tilbury church and c 100m south of Land Parcel 15 in the location of the Roman finds and Saxon coins. This is perhaps suggestive of an inhumation cemetery of Roman, Saxon or later medieval date.
- 1.4.20 The cropmark of a ploughed-out windmill was identified within the eastern part of Land Parcel 15 and this may date to the medieval or early post-medieval period.
- 1.4.21 The undated earthwork that runs west of the church and forms the southern boundary of Land Parcel 15 may be a significant feature. This is known as "soldiers graves" and may contain human bone or mark the boundary of a Saxon or medieval estate. It is possible this may be associated with the medieval hospital of St Mary.
- 1.4.22 The aerial survey identified a number of possible medieval linear and discrete features within Land Parcel 37. The linear features are in alignment and perpendicular to Station Road which may have originated as a medieval trackway. It is possible that these features represent a medieval or post-medieval farmstead or settlement activity.
- 1.4.23 The potential for early medieval archaeology within the site must therefore be considered to be high.

- 1.4.24 **Post-medieval and modern.** During the post-medieval period the site was used as agricultural land associated with several farmsteads in the vicinity. Two linear field boundaries (in Land Parcel 15) are shown on the tithe map of 1839 dividing this land parcel but had been removed by the time of the OS map of 1897. A small part of Land Parcel 15 at its south end was quarried in the later post-medieval period and this is likely to have removed earlier archaeological deposits within this area.
- 1.4.25 The Old Rectory was located within Land Parcel 16. Remains of this building may be located below ground as this field remains in pasture.
- 1.4.26 There may be military remains located within the site, particularly in Land Parcels 16 and 17 given the proximity to East Tilbury battery.
- 1.4.27 There is a high probability that remains of the Old Rectory are located within Land Parcel 16 and remains of post-medieval field boundaries are located within Land Parcel 15.

## 2 Project Aims

### 2.1 General aims

- 2.1.1 The general aims of the project were as follows:
- i. To establish the presence or absence of archaeological remains along the line of the scheme, and the extent of any areas where remains appear likely to be absent.
  - ii. In areas where archaeological remains are known or suspected, to clarify the reliability of the cropmark or geophysical survey evidence.
  - iii. In areas where no archaeological remains are indicated by aerial or geophysical survey, to clarify whether this apparent absence of remains is genuine.
  - iv. To determine the degree of complexity of any surviving horizontal or vertical stratigraphy, and in particular, to investigate areas where topography indicates the likelihood of deep deposit sequences for evidence of buried archaeological horizons and palaeo-environmental sequences.
  - v. Where remains are present, to determine the period(s) represented, the extent, state of preservation and character of the archaeological remains.
  - vi. To establish the range and state of preservation of archaeological artefacts, and through their recovery and examination, to establish the potential for information about the economy, status and contacts of past inhabitants of the scheme footprint.
  - vii. To determine whether palaeo-environmental remains are preserved, and, where these are found, to determine their types (e.g., charred plant remains, waterlogged remains, molluscan remains), state of preservation and potential for environmental information. This will be achieved through the recovery of samples from sedimentary sequences and archaeological features suitable for assessment of a range of palaeo-environmental remains (e.g., charred and waterlogged plant remains, charcoal, insects, pollen, diatoms, ostracods/foraminifera and molluscs) and scientific dating (e.g., radiocarbon and OSL dating).
  - viii. To investigate and record the extent, character and chronology of the sedimentary sequences, in particular those immediately adjacent to and in floodplains, contained within palaeochannels or in dry valleys, and to use the data to refine existing geoarchaeological (predictive) deposit models.
  - ix. To place any identified archaeological remains into their local and, where appropriate, regional or national context, and to assess the implications of any such discoveries for our current understanding of settlement and landscape change in the area, including an assessment of the associations of any remains with reference to the historic landscape.
  - x. To provide sufficient information to enable the LTC archaeological advisor, in consultation with the Key Archaeological Stakeholders, to determine the significance of the archaeological assets identified within the land parcel.

- xi. To provide a report on the discoveries to inform the Environmental Statement (ES) supporting the Development Consent Order (DCO) and support the preparation of a further archaeological mitigation strategy for the Enabling Works and Construction phases of the scheme.
- xii. Following the DCO, to deposit the report in the public domain, and to generate an accessible and useable archive which will allow future research to be undertaken.

## 2.2 Specific objectives

2.2.1 The specific project objectives were as follows:

- xiii. To conduct the programme of archaeological investigation within the general research parameters and objectives defined by the revised East of England Research Framework (Medlycott 2011), and to take account of the aims and objectives of the Greater Thames Estuary Historic Environment Research Framework.
- xiv. To clarify through targeting of apparently blank areas whether the cropmarks provide an accurate representation of the range, quantity and types of archaeological features present within the parcel.
- xv. To investigate activity carried out around burial monuments of the Neolithic and early Bronze Age, whether peripheral burial, deposits related to visits, or reuse for burial or other purposes in later periods.
- xvi. To look for evidence of early Bronze Age settlement or other activity in the wider area covered by WSI J.
- xvii. To clarify whether further features of the later prehistoric periods that are not evident from cropmarks survive, as suggested by the finds recovered within the area of WSI J, and in particular, whether there is further evidence of activity connected with Iron Age salt-working.
- xviii. To establish the character and date of pits in Land Parcel 37, and to determine whether these are all of one type or period, or whether they encompass several types and span several periods of activity.
- xix. To establish the date of the possible medieval or post-medieval field boundaries that have been identified within the land parcel, and to establish whether possible medieval droeways extend northwards through the land parcel;
- xx. To look for evidence of medieval and post-medieval farmsteads that may have been located along Princess Margaret Road and in Land Parcels 15 and 16.
- xxi. To look for further human remains associated with those already documented (or hinted at) in Land Parcels 15 or 16 of the site and determine whether any burials may be evidence associated with the elusive East Tilbury medieval hospital, or whether they date from an earlier period.
- xxii. To investigate the environs of early post-medieval standing buildings for evidence of associated buildings and other structures that would enhance our understanding of the layout, functions and development of these sites.

- xxiii. To investigate the site of the Old Rectory within Land Parcel 16 to establish the date of origin and character of this church residence.



## 3 Methodology

---

### 3.1 Constraints

- 3.1.1 No overhead powerlines or buried services were located in Land Parcel 37, but there were ecological constraints on the layout of the trenches.
- 3.1.2 These limitations were considered when designing the detailed trench layout, but due to observations made on site it was necessary to adjust the location of Trench 38.

### 3.2 Methodology for the evaluation

- 3.2.1 The total area of Land Parcel 37 was 5.8ha, and the area available for investigation excluding areas of services, hedgerows and other constraints was 5.1ha. A total of 42 trenches were excavated, with 41 trenches measuring 30m x 2m, and one trench measuring 18m x 10m. Combined, these represent a 5% sample of the area available for trenching. The location of the trenches is shown on Figure 2.
- 3.2.2 The trench design was developed to target cropmark features identified by the aerial investigation and mapping report (Place Services 2019), and otherwise to provide even coverage of the blank areas.
- 3.2.3 All trenches were located using a Global Positioning System (GPS) prior to machine excavation. All trenches were excavated using a tracked excavator fitted with a toothless bucket under constant archaeological supervision.
- 3.2.4 Revealed features were hand-cleaned and sampled by hand-excavation. They were recorded as outlined within the approved WSI. All finds were bagged by context throughout the evaluation and were recovered for further investigation, and soil samples were taken as appropriate.

## 4 Results

### 4.1 Introduction and presentation of results

- 4.1.1 The results of the evaluation are presented below and include a stratigraphic description of the trenches that contained archaeological remains. The full details of all trenches with dimensions and depths of all deposits can be found in Appendix A. Finds and environmental data are presented in Appendices B and C.
- 4.1.2 Context numbers reflect the trench numbers, unless otherwise stated. The first numerals of a context number repeat the trench number whilst allowing for a maximum range of 100 individual records for any one trench. For example, pit 603 is a cut within Trench 6, while ditch 2704 is a cut within Trench 27. Also Trench 6 has a potential record number range of 600-699, while Trench 27 has a range of 2700-2799.
- 4.1.3 An overview of the results for the site is shown on Figure 2. Further detailed plans of the trenches that contained archaeological features are shown on Figures 3, 5, 7, 9 and 11 and selected sections are shown on Figures 4, 6, 8, 10 and 12.

### 4.2 General soils and ground conditions

- 4.2.1 The soil sequence for the majority of the trenches comprised ploughsoil overlying subsoil, with an underlying geology of either sandy gravels or silty clay. On the sloped areas of the site, colluvial layers and deeper subsoil deposits were also recorded. Trenches 10, 15, 19, 31, 37, 39, 40, 41 and 42 all revealed accumulations of colluvial soils overlying the natural geology.
- 4.2.2 In Trenches 17 and 26 a silty gravel deposit was observed between the orange gravel natural and the subsoil. The origins and development of this deposit are unclear, but it was truncated by all associated archaeology and evidently predates the recorded human activity on the site.
- 4.2.3 Ground conditions throughout the evaluation were varied. During the initial stripping and excavation of features there was little rain and consequently the ground was dry and compact. During the fieldwork, the weather became more consistently wet, allowing the soils to become softer and less dusty. This did not result in any groundwater problems.

### 4.3 General distribution of archaeological deposits

- 4.3.1 Archaeological features were found in Trenches 1, 2, 6, 7, 8, 9, 11, 12, 13, 15, 16, 17, 18, 19, 21, 25, 26 - 29, 31, 34, 35, 37, 38 and 42.
- 4.3.2 The evaluation confirmed the presence of several linear, curvilinear and discrete features within the site that had been identified as cropmarks by the aerial investigation and mapping report (Place Services 2019). These features comprised boundary ditches, pits, postholes and possible sunken-featured buildings.
- 4.3.3 As indicated by the cropmark features, most of the features were confined to a 70m wide strip along the south-east edge of the site. Particularly dense

concentrations of discrete features were recorded in Trenches 17, 18, 27 and 28. This area of activity was associated with a series of enclosure ditches, the most significant of which were several ditches forming a NE-SW aligned boundary through Trenches 29, 18 and 16, and a return crossing Trenches 12 and 13, that bounded the main focus of activity on the NW and NE sides.

- 4.3.4 Several boundary ditches were also recorded towards the north end of the site, predominantly on NW-SE alignments in Trenches 1, 2, 7, 8, and 9.
- 4.3.5 A number of large sub-rectangular pits were also revealed that are likely to represent the remains of sunken-featured buildings. These were recorded in Trenches 12, 15, 16, 29 and 31.
- 4.3.6 A single unurned cremation was identified in Trench 19.
- 4.3.7 No archaeological features were revealed in Trenches 3, 4, 5, 10, 14, 20, 22, 23, 24, 30, 32, 33, 36, 39, 40 and 41 and these will not be described further.

#### 4.4 Trenches 17, 27 and 28 (Figs. 3, 4 and 5)

- 4.4.1 These three trenches were positioned close to the south-eastern boundary of the land parcel (**Fig. 2**).
- 4.4.2 **Trench 17** was located to the north-east of Trenches 27 and 28 (**Fig. 3**), targeting an area devoid of cropmark features. The excavation revealed a dense concentration of intercutting pits and postholes. At the northern end of the trench was a NE-SW aligned boundary defined by two large ditches, 1728 and 1729. Although left unexcavated, these appeared to truncate an earlier smaller ditch, 1727, recorded on a perpendicular alignment. Multiple sherds of early Roman (AD50-100) pottery were recovered from the surface of ditch 1728, alongside faunal remains from cattle, sheep and pig.
- 4.4.3 To the south of ditches 1728, 1729 and 1727 a total of twenty-eight pit and posthole-like features were recorded in the base of the trench and in section. All of the features were observed cutting through a layer of brown, silty sand and gravel, 1701. When first stripped it was difficult to differentiate between the fills of features and this earlier deposit, but subsequent weathering and cleaning clarified the difference, and showed that the archaeological features were cut through it. Although the origins of this material are not clear, it perhaps represents a buried soil horizon. No finds were recovered from this deposit.
- 4.4.4 Due to the removal of layer 1701 during excavation, several of the features were truncated and therefore only recorded in section (**Fig. 4**). Based on the observations in section, the features were typically truncated by between 0.35m and 0.4m. A small selection of the exposed features were investigated by hand.
- 4.4.5 Pit 1702 was sub-circular in plan with a diameter of 0.68m and a concave profile 0.18m deep (**Fig. 4**). It contained a single deliberate backfill, 1703 from which several sherds of pottery were recovered. These were predominantly late Bronze Age or early Iron Age in date, but a small (possibly intrusive) fragment of late Iron Age or early Roman (50BC-AD100)

pottery and a scrap of CBM (6g) were also recovered along with a small amount of briquetage and animal bone.

- 4.4.6 Pit 1704 was recorded in the west facing baulk of the trench (**Fig. 4; Plate 1**). It measured 1.24m wide, with steep sides and concave base, 0.6m deep. The earliest of its two fills, 1705 was particularly distinct as a deliberately dumped, yellow grey clay deposit, 0.18m thick. This was overlain by a probable backfill of dark grey silty sand, 1706. Deposit 1706 produced several sherds of late Bronze Age or early Iron Age pottery weighing a total of 111g, and multiple fragments of briquetage. The northern edge of the feature was partially truncated by a later pit, 1746. Although not fully excavated, it measured 1.3m in diameter and at least 0.55m deep. It contained a naturally accumulated fill of sandy silt (1747), overlain by a dump of darker siltier material (1748). Deposit 1748 produced two small sherds of late Bronze Age or early Iron Age pottery.
- 4.4.7 Partially visible in plan, pit 1730 measured 1.24m wide and 0.7m deep, with steep sides and a concave base (**Fig. 4**). It had a single fill of silty sand from which middle Bronze Age to early Iron Age pottery, Roman pottery and briquetage was recovered. It also contained cattle bones and other unidentified bones.
- 4.4.8 Features 1717, 1707 and 1709 were a cluster of prehistoric pits, each with steep sides and concave bases, that were recorded in the section of the trench. Pit 1709 was truncated partially by 1707 (**Fig. 4; Plate 2**). All three pits contained a single fill of dark brown grey, silty sand. Pit 1709 appears to be the earliest of the group, its fill (1710) producing 32g of middle Neolithic Peterborough Ware decorated with bird bone impressions, together with bird bone and other small fragments. Pits 1707 and 1717 both contained small quantities of middle Bronze Age or Iron Age pottery from deposits 1708 and 1718, respectively. Deposit 1708 filling pit 1707 also included animal bone including cattle fragments. Both fill 1708 and fill 1710 also produced fragments of briquetage, though the two from 1710 were small, and may be intrusive from the later pit 1707.
- 4.4.9 The remaining features recorded in plan varied in size from 0.3m to 0.75m in diameter, except for feature 1733, which was 1.73m across. A small sherd of late Iron Age or early Roman pottery (20BC-AD120) was recovered from the surface of pit 1714 and numerous fragments of briquetage were found on the surface of pit 1712. Pit 1716 had a small fragment of mammal rib recovered from its surface.
- 4.4.10 **Trench 27** was positioned approximately 30 to the south-west of Trench 17 and targeted a short NW-SE aligned linear cropmark. Two ditches recorded at the south-west end of the trench correlate well with this feature. Ditch 2702 was narrower and shallower than its recut 2704, but both ditches had sloping sides and rounded bases (**Fig. 4**, Section 2700). Each ditch contained a single fill of naturally accumulated sandy silt (respectively 2703 and 2705), containing Roman (AD120-240) pottery, animal bone and briquetage. Roman tile was also recovered from 2705, and a small amount of residual early Iron Age pottery was recovered from fill 2703 in ditch 2702. The environmental sample from fill 2705 (S.3) produced only small charcoal fragments and unidentifiable charred grains. Although the projected

alignment of ditch 2702 lay within Trench 28 to the north-west, no continuation was seen, and the cropmark continuation of ditches 2702/2704 ended before Trench 28 and was aligned on a more SE-NW alignment.

- 4.4.11 To the north-east of these ditches there was a dense scatter of sub-circular pits and postholes throughout the trench. The smaller examples were typically interpreted as postholes, but no post-pipes or packing were encountered and so they could equally be small pits. A sample of these features was excavated, comprising 2706, 2708, 2710, 2712 and 2714. Although they varied slightly in form and dimensions, they were broadly similar in appearance, containing single fills of dark, brownish grey sandy silt (**Fig. 3; Plate 3**). Pits 2708 and 2712 both produced small quantities of middle Bronze Age to early Iron Age pottery. Sampling of posthole 2714 (**Plate 4**) (S4) produced limited charred remains but did include some highly vitrified material, presumably from a kiln or hearth.
- 4.4.12 Most of the unexcavated features were all very similar in appearance and evidently also the remains of small pits or postholes. However, 2720, 2721 and 2723 were notably different. Only partially visible along the north-west edge of the trench, they appeared to be sub-circular in plan, but were distinguishable from the other features due to the presence of small chalk fragments at their surface. Pit 2727 was also distinguishable from the surrounding features, as it measured approximately 2.2m wide. The origins of the chalk are clearly not based in the underlying geology, and its purpose remains unclear.
- 4.4.13 At the north-east end of the trench were three ditches. Ditch 2735 was very narrow, and was orientated NW-SE, while ditches 2738 and 2739 ran NNE-SSW perpendicular to 2735, and less than 0.3m apart.
- 4.4.14 **Trench 28** was positioned 15m to the north-west of Trench 27. It was targeted on multiple cropmark features including a NW-SE aligned linear cropmark and several adjacent discrete features.
- 4.4.15 Ditch 2805 was orientated on a NW-SE alignment, and corresponded to the cropmark ditch. It had a concave profile, measuring 1.22m wide and 0.32m deep, with a single sterile fill of silty sand (**Fig. 5**).
- 4.4.16 A single small pit 2819, was partially truncated to the south-west of ditch 2805, but the remaining features all lay to the north-east of the ditch. These comprised a mixture of small postholes and larger pits totalling at least 69 identifiable features, plus a short ditch numbered 2860 (**Fig. 3; Plates 5 and 6**).
- 4.4.17 A sample of the features targeting examples of different sizes was excavated, comprising 2803, 2807 2810 and 2812. Posthole 2803 measured approximately 0.6m in diameter and 0.48m deep (**Fig. 5**). Backfilled with a silty sand deposit (2814), it contained a distinct post pipe, (2804) comprising dark grey, charcoal-rich material, including a late Bronze Age perforated clay disc, a possible pottery waster and a caprine (sheep or goat) metacarpal. An environmental sample (S.7) contained wheat and speedwell seeds.
- 4.4.18 Pit 2807 measured 2m x 1.46m in plan and was 0.59m deep with a flattish base (**Fig. 5**). It contained a rich fill of deliberately dumped material

including pottery and animal bone (**Plate 7**). The finds recovered included two sherds of Anglo-Saxon (c 400-750) pottery including an unusually decorated body sherd, but also comprised more than 300g of residual Roman pottery and fragments of briquetage, fired clay and animal bones (cattle, sheep and bird). The environmental sample recovered from fill 2808 (S.8) produced a mixture of charred wheat and barley grains. Postholes 2810 and 2812 (**Fig. 5**) both contained deposits of dark silty sand, but no artefacts were recovered.

- 4.4.19 Overall, there was a good correlation between the exposed features and the identified cropmarks with the larger pits, 2865, 2839, 2857, 2874, 2854, 2880 and 2807 all matching discrete cropmark features. Pits 2865, 2880 and 2857 each had Roman pottery on their surface, and pit 2854 produced both Roman pottery and a small sherd of Anglo-Saxon (AD450-750) pottery. Not surprisingly, the smaller discrete features did not show up as cropmarks.
- 4.4.20 Three small sherds (21g) of late Bronze Age or early Iron Age pottery were recovered from the surface of unexcavated pit 2823, a large oval soilmark in the south-west part of the trench. Animal bone was recovered from 2858, 2860 and 2880 although it was mostly too small to be identified.

#### **4.5 Trenches 38, 29, 18, 16, 26, 12 and 13 (Figs. 6, 7, 8, 9 and 10)**

- 4.5.1 These trenches were positioned in the south-east half of the site, each targeting the linear and curvilinear cropmark features that were mapped in this part of the land parcel (**Figs. 2 and 6**).
- 4.5.2 **Trench 38** was located approximately 30m to the south-west of Trench 28 after being relocated due to ecological constraints. The north-west end exposed a dump of modern debris including possible asbestos fragments and was immediately backfilled. The area of disturbance affected an area almost 10m long, and immediately south-east of this was root disturbance recorded as tree-throw hole 3808. This prevented the evaluation from establishing whether the ditches 2905 and 2907 in Trench 29, and the more north-westerly cropmark ditch continuing south-west from Trench 29, continued as far as this.
- 4.5.3 Located in the middle of the trench was a NE-SW aligned linear feature, numbered 3809. It was left unexcavated but was broadly aligned with ditch 2903 to the north-east and to the linear cropmark to which it corresponded, and may represent a continuation of this.
- 4.5.4 Pits 3802, 3804 and 3806 were recorded at the south-east end of the trench. The largest of these, 3802 was not fully exposed but measured at least 1.04m wide and 0.43m deep (**Fig. 7**). All three features were filled with a single deposit of dark brown clay silt. No artefacts were recovered from these features.
- 4.5.5 **Trench 29** lay north-east of Trench 38 and was positioned immediately north-west of Trench 28. It was targeted on one linear and two discrete cropmark features.

- 4.5.6 Ditch 2903 lay towards the SE end of the trench, and was orientated NE-SW, coinciding with the line of a linear cropmark. It measured 1.2m wide and 0.35m deep, with a concave profile (**Fig. 7**). At the base of the ditch was a primary fill, (2913) of gravelly sandy silt, overlain by a naturally silted deposit of grey, brown sandy silt (2904), from which briquetage fragments, Iron Age pottery and a horse mandible were recovered.
- 4.5.7 Approximately 1m to the north-west and on a parallel alignment was ditch 2905. This had a distinct V-shape profile, 1.15m wide and 0.7m deep. Although the relationship was uncertain, this appears to have been recut along its north-western side by ditch 2907 (**Fig. 7; Plate 8**). This later ditch had a much shallower profile and was only 0.47m deep. Both ditches were filled with very similar dark grey-brown sandy silts, which may suggest they were broadly contemporary. Fill 2906 from ditch 2905 produced a small sherd of middle Bronze Age to Iron Age pottery and fill 2908 from ditch 2907 produced late Bronze Age or early Iron Age pottery and cattle bones. Both features produced fragments of briquetage.
- 4.5.8 The NE-SW linear cropmark was dividing at the point where Trench 29 crossed its line, but only one ditch (2903) was found corresponding to it. It is possible that the more south-easterly arm of the cropmark corresponds to ditch 2903, and the more north-westerly arm to ditches 2905 and 2907.
- 4.5.9 A small pit or posthole, 2910 (**Fig. 7**) was midway along the trench and contained no dating evidence.
- 4.5.10 Adjacent to this, feature 2909 corresponded to a discrete cropmark, but was of very different shape in plan, and was left unexcavated, as was a large pit (2912). Pit 2912 was not fully exposed but measured at least 3.5m x 2.5m in plan with a broadly sub-rectangular shape. This feature may represent the remains of a sunken featured building.
- 4.5.11 There was no evidence for a continuation of ditch 2805 from the adjacent trench to the south-east.
- 4.5.12 **Trenches 18 and 16** were both targeted on a NE-SW linear cropmark correlating with ditch 2903. They were also placed across a curvilinear cropmark running roughly parallel, and a large discrete feature. Trench 18 was positioned c 70m north-east of Trench 29 and Trench 16 was a further 20m to the north-east.
- 4.5.13 A linear boundary formed by recutting ditches, 1806, 1804, 1808 and 1824 corresponded with the linear cropmark. The earliest ditch in the sequence was 1806, later recut to the north-west by 1804 (**Fig. 9; Plate 9**). These were both filled by similar dark grey-brown sandy silts and the fill of ditch 1804 contained a small fragment of tile.
- 4.5.14 Ditch 1808, which truncated ditches 1804 and 1806, had a much broader profile, approximately 1.8m wide. The base of the ditch was not exposed, but measured at least 0.75m deep, with a lower fill (1810) of purplish grey, sandy silt. Burnt stone and fired clay were recovered from this deposit, including briquetage fragments and kiln furniture, together with a fragment of tile. The environmental sample from fill 1810 (S.2) produced a limited flot of poorly preserved charcoal and grain. Ditch 1824 truncated the south-eastern edge of ditch 1808 and lower fill 1810 but was clearly dug while

ditch 1808 was still open, as above its lower fill (1825) the upper part of both ditches was filled by a natural silted deposit (1809). A parallel ditch (1823) was only partly exposed at the very north-west end of the trench.

- 4.5.15 Ditch 1819, towards the south-eastern end of the trench, was not indicated on the cropmark data. It was aligned on a N-S orientation, terminating within the trench adjacent to ditch 1803. It measured 0.7m wide and 0.27m deep, with a single fill of sterile purplish grey-brown sandy silt (**Fig. 10**). Ditch 1803 corresponded to the curvilinear cropmark targeted by both Trenches 18 and 16. It was excavated in Trench 16 as ditch 1605 (see below).
- 4.5.16 Several small pits or postholes were also revealed in Trench 18. Posthole 1811 measured 0.45m in diameter with a shallow flat base 0.13m deep, and had a purplish grey-brown fill. Postholes 1813 and 1815 both contained similar fills but varied slightly in form (**Fig. 10**). None of these features contained finds.
- 4.5.17 A shallow pit, 1821 was recorded in the section at the south-east end of the trench. It also contained a dark purplish grey sandy silt fill, yielding late Iron Age or early Roman (50BC-AD100) pottery and animal bone (**Fig. 10**).
- 4.5.18 Pits 1817 and 1818 were recorded but not excavated.
- 4.5.19 **Trench 16** exposed both of the parallel cropmark ditches, and the more south-easterly curvilinear ditch, here numbered 1605, was excavated. It was 1.85m wide and 0.59m deep with moderately steep sides and a broad flat base, and was filled with a primary slump of gravel material down its north-western edge (1609), overlain by a naturally accumulated deposit of purplish grey sandy silt (1606) (**Fig. 9; Plate 10**). Fill 1606 produced briquetage, animal bone, two small sherds of Iron Age pottery and a fragment of tile. Ditch 1613 was on a parallel alignment to ditch 1605 and was only 1.5m to the north-west, and measured 0.6m wide and 0.27m deep (**Fig. 6**).
- 4.5.20 Ditches 1612 and 1607 at the north-west end of the trench corresponded to the linear cropmark boundary also exposed as ditches 1806, 1804, 1808, 1824 and 2903 in Trenches 18 and 29 to the south-west. Ditch 1612 was not excavated, but ditch 1607 proved to be 0.5m wide and 0.12m deep, with a single sterile fill.
- 4.5.21 A large sub-rectangular pit at the south-east end of the trench (pit 1610) measured at least 2.6m x 2m in plan and 0.45m deep (**Fig. 9**). It contained a single fill of naturally silted dark purplish grey silt (1611), from which several fragments of briquetage were recovered. There were also fragments of horse and cattle bone from this deposit. The briquetage has been broadly dated to between the late Bronze Age and Roman periods, but the form of the feature is consistent with that of a possible sunken-feature building.
- 4.5.22 Less than 2m to the north-west of pit 1610 was a small posthole numbered 1603. A small sherd of Iron Age pottery was recovered from this feature.
- 4.5.23 **Trench 12** was positioned less than 7m to the ENE of Trench 16 and was orientated to target two intersecting linear cropmarks and several discrete cropmarks. Ditches corresponding to both linear cropmarks were located within the trench; the NE-SW cropmark (probably a continuation of the



curvilinear cropmark identified as ditch 1605) was recorded as ditch 1213 and was cut by a ditch corresponding to the NW-SE cropmark, which was recorded as ditch 1206 (**Fig. 6**).

- 4.5.24 Ditch 1213 measured 2.3m wide, but was not investigated by hand, although a large mammal rib was recovered from the top fill.
- 4.5.25 Ditch 1206 was 1.08m wide and 0.4m deep, and contained a single fill of light grey brown, silty sand. A sherd of post-medieval pottery (c1680-1800) and a fragment of roof tile were recovered from this ditch. A second ditch 1212 on a WNW-ENE alignment, which did not show as a cropmark, also cut the fill of ditch 1213, but was not excavated.
- 4.5.26 A fourth ditch (1208) was recorded at the opposite end of the trench on a broadly parallel alignment to 1213. Ditch 1208 measured 0.6m wide and two small fragments of prehistoric pottery were recovered from its surface. In plan it appeared to be truncating a circular pit (Pit 1214).
- 4.5.27 Small pits 1202, 1217, 1216, 1209, 1204, 1211 and 1215 were recorded along the trench (**Figs 6 and 7**). Pit 1202 had steep sides and a flat base and was filled with a dump of charcoal-rich material (1203), incorporating fragments of fired clay, animal bone and a large quantity (351g) of late Bronze Age or early Iron Age pottery and fired clay including briquetage and hearth structure. The environmental sample from deposit 1203 (S1) contained some poorly preserved charred wheat and fragments of hazelnut. This pit was cut by a smaller and much shallower pit 1217 (**Fig. 7**), whose fill did not produce finds.
- 4.5.28 Pit 1204 was similar in form and also contained a deliberate backfill of dark silty sand that included fragments of fired clay. The remaining pits were left unexcavated, but several small fragments of middle Bronze Age or early Iron Age pottery were recovered from the surface of pit 1209.
- 4.5.29 A large sub-circular pit numbered 1210 was located near the centre of the trench but was not excavated. It measured 3m x 2.5m with an upper fill of dark greyish brown sandy silt (**Fig. 6; Plate 11**). A small amount of fired clay and early Iron Age pottery was recovered from the surface.
- 4.5.30 **Trench 13** was positioned approximately 20m to the south-east of Trench 12, and was located to investigate two linear cropmark features, one the NW-SE ditch identified as 1206, the other a slightly curving cropmark on a NNW-SSE alignment, possibly representing a return of the curvilinear ditch 1213.
- 4.5.31 The cropmark continuing from ditch 1206 to the north-west coincided with a broad ditch (Ditch 1304/1306) in Trench 13, although this was on a NNW-SSE alignment rather than the NW-SE alignment of the cropmark. The ditch measured 4.2m wide and at least 0.6m deep, although it was not fully excavated (**Figs 6 and 8; Plate 12**). There were two fills, the earlier of which (1307) was confined to the south-east edge, and for this reason the ditch was interpreted on site as of two phases, the earlier ditch (1306) to the south-east, cut by a recut of very similar depth and profile numbered 1304, with a single homogenous fill (1305). Several fragments of degraded animal bone and three small fragments of Roman pottery (AD350-410) were retrieved from deposit 1305.

- 4.5.32 Ditch 1302 was located near the north-east end of the trench on a similar alignment to 1304. It had a very shallow, concave profile 0.99m wide and 0.14m deep with a single sterile fill (**Figs 6 and 7**).
- 4.5.33 Ditch 1308 correlated with the other linear cropmark and measured 1.7m wide with a top fill of dark grey sandy silt, but was not excavated. A ditch on a N-S alignment (Ditch 1310) was exposed further to the south-west, and there were three linear features aligned NW-SE (features 1309, 1314 and 1317) the last of which terminated within the trench. Feature 1309 was excavated and measured 0.4m wide and only 0.04m deep. Although recorded as the base of a plough furrow, as no furrows were recorded either in Trench 12 to the north-west or Trench 17 to the south-west, it may alternatively have been a ditch.
- 4.5.34 Four small discrete features were also revealed: 1311, 1313, 1315 and 1316. Pit 1311 was excavated and was 0.7m in diameter and 0.38m deep with steep sides and a concave base. Its single fill contained fragments of chalk, fired clay, tile and burnt flint.
- 4.5.35 **Trench 26** was positioned midway between Trenches 29 and 18 and targeted a linear cropmark aligned NW-SE and two discrete cropmarks. Due to the dark colour of the surrounding loose sandy natural, into which particles from the subsoil and feature fills had percolated, many of the features were not distinguishable during machine excavation and were subsequently recorded in section.
- 4.5.36 The targeted cropmark was recorded as ditch 2608. It measured 0.92m wide and 0.38m deep and had a steep-sided, concave profile, with a single fill of dark grey silty gravel but no finds (**Fig. 10**). Ditches 2617 and 2616 were recorded approximately 4m to the north-east, on a parallel alignment to 2608. They also had similar profiles and fills.
- 4.5.37 A cluster of pits were recorded at the north-east end of the trench, including 2607, 2614, 2615, 2612, 2605 and 2603. These were of varying dimensions and some were only seen in section (**Fig. 10**).
- 4.5.38 A small post hole numbered 2610 was recorded in the north-west facing section. It had vertical sides and a flat base with a single fill of dark grey sandy silt (**Fig. 10**).

#### 4.6 Trenches 1, 2, 6, 7, 8, 9 and 11 (Figs. 11, 12 and 13)

- 4.6.1 These trenches were located at the north-east end of the site and revealed numerous boundary ditches and some discrete features that were not indicated by the cropmark evidence (**Figs. 2 and 11**).
- 4.6.2 **Trench 1** was positioned in the northern corner of the site. Ditch 107 was revealed near the north-west end on a NE-SW alignment. It had a shallow concave profile and a single fill containing several small sherds of Roman pottery. A little more than 2m to the south-east was a parallel and larger ditch, numbered 105. This also had a shallow concave profile and a single fill (**Fig. 12**) that contained a fragment of Mayen lava quern, indicating a Roman or later date. A later prehistoric flint knife was also recovered from the fill of this ditch. Both ditches were recorded in plan truncating curvilinear

ditch 114, which was not further investigated. No continuation of ditch 105 was found in Trench 6 to the south-west.

- 4.6.3 Close to the centre of the trench were multiple intercutting features (**Figs 11 and 12; Plate 13**). Although not fully exposed or bottomed, cut 109 appears to have been a large pit with undercut sides. It contained three mixed fills (none of which contained finds) that appear to have been deliberately backfilled into the pit. The upper levels were truncated by large ditch 120, which was orientated NE-SW, measured at least 2m wide and 0.56m deep and contained a natural silted deposit of dark brown sandy silt (110). Pottery dating to the middle Bronze Age or Iron Age and the Roman period (AD120-200) was recovered from this ditch, along with a small sherd of medieval (c1100-1350) pottery. Other finds included animal bone, fired clay, Mayen lava quern and fragments of iron. At the north-west edge of the ditch, a stakehole or an area of bioturbation by tree-rooting (118) was also recorded (**Fig. 12**).
- 4.6.4 Ditch 102 truncated the south-east edge of ditch 120 and was orientated on a NE-SW alignment. It had steep sides and a flattish base with two fills (104 and 103). A small (2g) sherd of medieval pottery (c1270-1550AD) was recovered from fill 103.
- 4.6.5 Another two ditches, 112 and 111, were observed at the south-east edge of ditch 102. Ditch 112 was on the same alignment as ditch 102, and was cut by ditch 111, which ran on a NNE-SSW alignment. Their relationship with ditch 102 was not established.
- 4.6.6 **Trench 2** was located 15m to the south-east of Trench 1, on a perpendicular alignment. At the north-east end was a large pit or possible ditch terminus numbered 203. It measured 1.7m x 0.86m in plan, but had a shallow flat profile, being just 0.17m deep, and had a single sterile fill. It is dubious whether this feature was of archaeological origin.
- 4.6.7 Two small pits, 205 and 211, were recorded on the south-west side of feature 203. Pit 205 was excavated and was 0.34m across and 0.12m deep. Both pits had dark but sterile silty clay fills.
- 4.6.8 Feature 207 was partially revealed in the trench, with a sub-circular shape in plan and a side shelving to a flat base (**Figs 11 and 12**). Its lower fill (209) was a mottled clay without finds, the upper fill (208) was a mid-grey sandy silt that yielded several small scraps of prehistoric and medieval (c1100-1350) pottery.
- 4.6.9 At the south-western end of the trench was a broad NW-SE aligned ditch numbered 210, whose top fill contained a small amount of fired clay. Projection of its line to the south-east coincides with ditches 806 and 805 in Trench 8.
- 4.6.10 **Trench 6** was located at the north-west edge of the site, south-west of Trench 1. It revealed a very shallow concave ditch (603) on a NE-SW alignment, which terminated within the trench (**Figs 11 and 12**). A small sherd of Anglo-Saxon pottery (AD400-750) was recovered from the fill. A small pit (605) was also recorded but was not excavated. The south-western part of the trench contained a plough furrow (606).

- 4.6.11 **Trench 7** was positioned 14m to the south-west of Trench 2 and revealed two converging ditches at the south-east end of the trench, meeting partway up the north-east side. The western and earlier ditch (707) was on a NNW-SSE alignment, the eastern ditch (705) was aligned NW-SE, and ran along the edge of the trench, and was not fully exposed. Ditch 707 was only 0.05m deep, while ditch 705 was at least 0.5m wide and 0.2m deep (**Fig. 12**); both had single homogenous fills of greyish brown silty clay. Anglo-Saxon and Medieval (c AD 1175-1350) pottery were recovered alongside indeterminate animal bones from fill 706 in ditch 705. The projected line of ditch 705 is slightly offset from ditch 808 in Trench 8 to the south-east, but could still represent a continuation of it.
- 4.6.12 A single small sterile pit (703) was also found and excavated adjacent to ditch 707.
- 4.6.13 **Trench 8** was positioned to the south-east of Trench 7 and south of Trench 2. At its north-east end were two NW-SE aligned ditches, numbered 806 and 805, which appeared to be on a similar line to ditch 210. Neither was excavated, but a small amount of Roman (AD120-200) pottery was recovered from the surface of ditch 806.
- 4.6.14 Ditches 803 and 808 were found at the centre of the trench on a NNW-SSE alignment and were excavated by hand. Ditch 808 was the earlier of the two and was recut on the east side by ditch 803; both ditches were broad and shallow with shallow and slightly pointed profiles (**Fig. 12**). Ditch 808 contained a sterile deliberate backfill and 803 contained two naturally silted deposits containing a fragment of medieval or post-medieval roof tile and a small quantity of middle Bronze Age or Iron Age pottery. The projected alignment of ditch 803 also coincides with the position of ditch 210 to the north, although the alignment of 210 is different.
- 4.6.15 **Trench 9** was located 30m to the south-east of Trench 8. It revealed a NW-SE aligned ditch at its northern end, which was only partly exposed within the trench. This was investigated at two locations, recorded as 905 and 902. It was at least 1m wide and up to 0.46m deep, with a shallow concave profile. At the north-west end of the trench it almost completely truncated a small portion of an earlier feature (907) (**Fig. 13**). It is unclear if this was a pit or ditch. No dating evidence was recovered from either of the features. The extrapolated alignment of ditch 905/902 suggests that it may be a continuation of boundary ditches 806 and/or 805. On the eastern side of the ditch sub-rectangular feature 904 was investigated but proved to be natural.
- 4.6.16 No continuation of ditch 1213 was found in Trench 9, suggesting that the cropmark accurately showed the extent of this ditch, and that it returned to the south-west before reaching Trench 9.
- 4.6.17 **Trench 11** was positioned immediately south of Trench 8. It revealed a single ditch (1104) on a NNE-SSW alignment. Ditch 1104 had a very shallow concave profile 0.62m wide and 0.12m deep (**Fig. 13**). It contained a sterile, light grey fill of silty clay and did not appear to continue into any adjacent trenches.

## 4.7 Trenches 15, 19, 25, 31 and 21 (Figs. 14, 15 and 16)

- 4.7.1 These trenches were located south-west of the trenches just described, occupying a central band on the slope that dropped north-westwards away from the area of cropmarks and concentration of archaeology on the higher ground to the south-east (Figs. 2 and 14).
- 4.7.2 **Trench 15** was positioned to the west of Trench 11. Orientated on a NW-SE alignment the trench ran perpendicular to the contours of the sloping field, falling by 2m from south-east to north-west.
- 4.7.3 A large sub-rectangular pit was revealed on the higher ground at the south-east end. Pit 1504 measured 2.62m x at least 2m in plan and 0.38m deep with steep sides and a flat base (Fig. 15; Plate 14). The lower fill was a naturally silted brownish grey sandy silt (1505) which produced several sherds of Anglo-Saxon (AD400-750) pottery, fired clay and a fragment of Roman brick. This was overlain a darker deposit of sandy silt (1506) which contained fired clay. This feature is potentially the remains of a sunken-feature building.
- 4.7.4 A small pit, 1507 was recorded to the south-east of 1504, but left unexcavated.
- 4.7.5 The natural geology was not exposed in the north-west half of the trench due to the depth of colluvium at this end.
- 4.7.6 **Trench 19** was positioned 18m to the south-west of Trench 15. Excavated to a depth of 1m along its length, deep colluvial layers prevented the natural gravels from being exposed along its entire length. At the south-west end of the trench was a circular, unurned cremation (cremation1903). It was not excavated as it was already 1m below the existing ground level.
- 4.7.7 **Trench 25** was located south of Trench 19, at the top of the break of slope. It revealed a single ditch, which was aligned NW-SE and was numbered 2502 (Fig. 15; Plate 15). The ditch measured 1m wide and 0.25m deep and was filled by a primary gravel fill overlain by dark brown sandy silt. No artefacts were recovered from this ditch.
- 4.7.8 Adjacent to the ditch on the south-west side a sub-rectangular soilmark numbered 2505 was also excavated but proved to be of natural origin.
- 4.7.9 **Trench 21** was positioned against the north-west edge of the site, north-west of Trench 15. A large shallow pit (2103) was partially exposed at the north-west end. It measured at least 2m wide and was up to 0.4m deep, the deeper side being near-vertical and the base shelving up to a less-pronounced edge on the opposite side (Fig. 15). It was filled by a grey brown clay silt containing several sherds of Anglo-Saxon pottery. Although not fully exposed, and not of classic profile, this pit may represent the remains of a sunken-feature building.
- 4.7.10 Ditch 2105 was found near the middle of the trench, and was orientated NE-SW, but was not excavated. No continuation of this ditch was seen in Trench 22 to the SW, which was devoid of archaeology.
- 4.7.11 **Trench 31** was located over 60m to the west of Trench 25 on a NW-SE alignment, following the slope of the field. The features in the south-east

half of this trench were sealed beneath a layer of colluvium 3103, which produced a single sherd of late Bronze Age to early Iron Age pottery.

- 4.7.12 Near the centre of the trench was a large sub-circular feature, 3115. It measured 3.15m by at least 2m in plan but continued beyond the north-east baulk of the trench. It was 0.49m deep with moderately steep sides and a flat base, with a fill of dark greyish brown sandy silt (3116) that contained Anglo-Saxon pottery (c 400-750AD) and a residual sherd of prehistoric pottery (**Fig. 15**). An environmental sample from deposit 3116 (S.5) produced only charcoal fragments and possible charred wheat. Revealed beneath the pit close to the south-western edge was posthole 3121 (**Figs 14 and 16**), whose fill was the same as that of the pit. As the posthole was not seen cutting the pit, it may have been contemporary or earlier than the pit, but as its fill was identical it is likely that this was a contemporary posthole, suggesting that this may have been a sunken-featured building.
- 4.7.13 To the north-west of pit 3115 were a large pit 3104 and smaller pits of varying size, comprising 3112, 3113, 3110, 3108, 3106 and 3105. Most of these features were only revealed in section (**Fig. 15**) following hand cleaning of the trench, and none was excavated by hand.
- 4.7.14 In the south-east half of the Trench 31 was a steep-sided pit or posthole, (3117), revealed at the edge of the excavated area. This was at least 0.48m deep but as it was more than 1m below ground could not be fully excavated for Health and Safety reasons (**Fig. 16**). There were no finds. Pit 3119 near the south-east end of the trench was truncated during machining. It was 0.34m in diameter but only survived 0.04m deep, although several sherds of middle Bronze Age to Iron Age pottery came from the fill.

#### 4.8 Trenches 34, 35, 42 and 37 (**Figs. 17 and 18**)

- 4.8.1 This group of trenches were located along the south-west edge of the site, where the field was steeply sloped from the north-east down to the south-west (**Figs. 2 and 17**).
- 4.8.2 **Trench 34** was located at the north-west edge of the site and west of Trench 31. It revealed a single ditch, 3402 (**Fig. 18**) that was aligned NW-SE and contained a sterile deposit of silty clay.
- 4.8.3 **Trench 35** was located immediately to the south-east of Trench 34 and revealed three parallel ditches on the same NW-SE alignment as ditch 3402. Ditches 3502, 3504 and 3506 each had shallow concave profiles, and a single naturally silted fill (e.g., 3502: **Fig. 18**). No artefacts were recovered from these features. Ditch 3502 is potentially a continuation of ditch 3402 based on its alignment and projected line. No continuations of the other two ditches were seen in Trench 34.
- 4.8.4 **Trench 37** was located west of Trenches 28 and 29. It revealed a NW-SE aligned ditch (Ditch 3702) that had a concave profile and a single fill of dark grey-brown sandy silt (**Fig. 18**), but no finds. It was on the same alignment as ditch 2805 in Trench 28 further to the east. Although it did not match the precise location, ditch 3702 ran parallel to a field boundary identified on 19th century historic mapping (OA2020, fig. 7).

- 4.8.5 At the north-east end of the trench was a 7.5m spread of modern disturbance and dumped material, similar to that observed in Trench 38, to the south-east. It appears that a field boundary formed at this location was used to dump waste material from the 19th century onwards.
- 4.8.6 **Trench 42** was located in the southern corner of the site, and south of Trench 37. It was aligned NE-SW and ran down the slope leading to the estuarine flood plain to south-east. Ditch 4202 was recorded in the middle of the trench, on a NW-SE alignment, midway down and perpendicular to the slope. It was cut through colluvial deposit (4201) and contained a single naturally silted fill incorporating both Iron Age and post-medieval pottery (c1580-1750) and CBM (**Fig. 18**).
- 4.8.7 Ditch 4204 was partially exposed at the south-west end of the trench and although slightly offset, correlates with a field boundary mapped on the 1st edition OS map (ibid., fig. 7). The position of this ditch was also still visible on the surface of the field through differential growth of the grass.
- 4.8.8 No continuations of either ditch were seen in Trench 40 to the north-west, both Trenches 40 and 41 being devoid of archaeology other than containing deposits of colluvium.

## 4.9 Finds summary

- 4.9.1 **Prehistoric pottery.** The evaluation uncovered 142 sherds (1414g) of hand-collected prehistoric pottery from 30 contexts across 11 trenches. One context dated to the middle Neolithic, and the remaining contexts probably date to the late Bronze Age or early Iron Age, although spot-date ranges often include a wider span of dates.
- 4.9.2 **Roman pottery.** A total of 125 sherds of pottery, weighing 1010g, were recovered from the evaluation. Sherds representing 9% of the assemblage belonged to context-groups spot-dated to the late Iron Age or early Roman period (c 50 BC-AD 100/120), and 84% of the assemblage from context-groups spot-dated to the early Roman period (c AD 43-100/120). Just four sherds came from context-groups spot-dated to the middle Roman period (c AD 120-240), and one sherd of Oxford red colour-coated ware indicates a continuation of activity into the late Roman period.
- 4.9.3 **Medieval and post-medieval pottery.** A total of 26 sherds of early medieval, medieval and post-medieval pottery weighing 267g were recovered from 12 contexts. It mostly represents ordinary domestic pottery typical of the region. Over half of the sherds (14) are of early to mid-Saxon date, including a jar with unusual crudely incised lattice-like decoration. Nine sherds dated to the high medieval period, and only 3 sherds to the late or post-medieval period.
- 4.9.4 **Flint.** A very small assemblage of eight struck flints and a larger assemblage of 102 fragments of burnt unworked flint weighing 3326g was recovered from this evaluation, including a late prehistoric knife from context 106.
- 4.9.5 **Fired clay.** A modest quantity of briquetage and fired clay amounting to 333 fragments weighing 2092g was recovered from eleven trenches mainly concentrated in Trenches 12, 15-18 and 26-29. Much of the material is

reliant on associative dating, although a perforated plate from deposit 2804 and fragments of briquetage pedestals date to the late Bronze Age, and other briquetage to the late Bronze Age or Early Iron Age. Other items of furniture are dated to the Iron Age or Roman periods, including a possible oven plate in feature 1610.

- 4.9.6 **Ceramic building materials.** A total of 16 fragments of ceramic building material (CBM) weighing 513g were recovered, including a flat tile and one possible brick, but none are sufficiently complete for any further interpretation.
- 4.9.7 **Metals.** Seven iron objects weighing a total of 56.5g were recovered from the site during evaluation. The only identifiable object is a section of a knife blade from context 110.
- 4.9.8 **Worked Stone.** A total of 19 pieces of stone were recovered, including 15 fragments of Mayen lava weighing 384g from three separate contexts (106, 110, 3116).

## 4.10 Environmental summary

- 4.10.1 **Charred plant remains and charcoal.** Seven bulk samples were taken from a range of features across the site. Of these, one was late Bronze Age or early Iron Age, one Roman, two early medieval (Anglo-Saxon) and three were undated. The relatively small number of samples taken, and the large number of features that were not excavated need to be borne in mind when attempting to draw conclusions from these samples.
- 4.10.2 The results from the samples from features dated to the Roman and Anglo-Saxon periods suggest only a limited potential for charred remains in these periods. In contrast, the sample from late Bronze Age/early Iron Age pit 1202 produced both grain and cereal chaff as well as charcoal.
- 4.10.3 **Animal bone.** A total of 516 animal bone fragments weighing 3.56kg was recovered from the site, most of which were collected by hand. Of these, 182 fragments have been identified representing a mixture of fauna and demonstrating good potential for preservation in some trenches.



## 5 Discussion

### 5.1 Reliability of field investigation

- 5.1.1 The layout of trenches provided good overall coverage of the site, with the exception of the low-lying south-west edge of the land parcel, for which permission to excavate was not obtained during this phase of fieldwork.
- 5.1.2 Over the duration of the fieldwork the trenches were subjected to a mixture of weather conditions, which assisted in helping the archaeology to weather out. Consequently, the features were easily distinguishable from the Lynch Hill Gravels, Head deposits and Thanet Sand through which they were cut. Exceptions to this were encountered in Trenches 17 and 26, where the features were difficult to differentiate from the diffuse interface through which they were cut. Although this led to some machine truncation of the features, they were still identifiable in plan and section.
- 5.1.3 In Trenches 39, 40, 41, 42, 19, 15 and 10 the accumulation of colluvium meant that the natural geology and archaeological horizon could not be fully exposed. However, the impact of this on the reliability of the evaluation results is relatively limited, as in Trenches 39, 40, 41 and 42 the steep slope means that it is unlikely that significant archaeological activity took place here. In Trenches 10 and 19, where the natural geology was exposed over half and more than half of the trench respectively, the revealed features probably provide a reasonably representative view of the likely density of features overall, and only in Trench 15, where the natural was only exposed at one end, is it impossible to gauge what may lie below the colluvium.
- 5.1.4 Due to the varied nature of the geology and topography, features deemed probably to be natural, but with some potential to be of archaeological origin, were sample excavated to establish if they were of geological or archaeological significance. Invariably these were shown to be no more than variations in the natural sands and gravels, but they provided the team with a benchmark for the positive identification of archaeologically significant deposits.
- 5.1.5 Overall, there was a reasonable correlation between the aerial survey cropmarks and the archaeological features observed, but the results varied across the site. Along the south-east side of the site the linear and curvilinear cropmarks corresponded to underlying ditches, and some of the large discrete cropmark features matched pits. However, there were many more smaller pits, postholes and ditches that were not indicated by cropmarks. Equally, there were a reasonable number of features to the north and north-west that were not previously indicated by cropmarks.
- 5.1.6 The variability in the cropmark accuracy can be directly linked to the type of underlying geology, as cropmarks were only mapped where the Lynch Hill gravels occur, but it is also true that, while the archaeological features were not restricted to the areas of gravel geology, they were predominantly located here.
- 5.1.7 The density of remains has meant that it was not practical to excavate all the features revealed. Inevitably the date of the unexcavated remains

cannot be determined unless they produced a reasonable quantity of artefacts on their surface. It should also be considered that, due to the clear evidence for multiperiod activity on the site, there is likely to be a moderate amount of residuality within much of the finds assemblage, and this inevitably reduces the reliability of the dating and phasing from the limited sample of the archaeology that was examined.

## 5.2 Interpretation

- 5.2.1 **Mesolithic/Neolithic.** Very few lithic artefacts were recovered from this land parcel during the evaluation and none were identifiable as Mesolithic or earlier. Pit 1709 does appear to be dated to the middle Neolithic based on the pottery and although it did also contain a small 6g fragment of briquetage dated to the late Bronze Age or later, this is probably intrusive. Although this was the only feature from the evaluation to be dated to this period, it is quite possible that some of the unexcavated features that did not produce surface finds are also Neolithic.
- 5.2.2 **Late Neolithic/Early Bronze Age and Middle Bronze Age.** No artefacts or features or late Neolithic or early Bronze Age date were identified during the evaluation. Despite spot dating of the pottery listing material as middle Bronze to Iron Age, none of the pottery was diagnostically middle Bronze Age, and all of the material may have been late Bronze Age or early Iron Age in date.
- 5.2.3 **Late Bronze Age to Iron Age.** Activity on the site during the late Bronze Age and Iron Age is well represented, with a particular concentration of features on the elevated gravel geology in Trenches 28, 29, 27, 17, 16 and 12. Ditches belonging to the main NE-SW aligned ditched boundary identified in Trenches 38, 29, 18, and 16 also contained material of these periods; 2903 and 2905 both produced a small amount of pottery dated to the late Bronze Age or Iron Age and ditch 2907 contained a particularly large assemblage comprising 351g of late Bronze Age pottery. The curvilinear ditch in Trenches 16 and 18 was also tentatively dated to the Iron Age on the basis of two sherds of pottery, making it possible that the area of activity on the higher ground was initially enclosed at some point during the late Bronze Age or early Iron Age. There were, however, also fragments of tile in cuts 1806, 1809 and 1605 of the NE-SW ditch, and it is therefore equally possible that the prehistoric finds are residual in these features, rather than that the tile is intrusive.
- 5.2.4 Two ditches were located to the south-east of the main NE-SW aligned boundary and perpendicular to it (ditches 2805 and 2608), neither of which contained any finds. These presumably sub-divided the area or formed a small enclosure off the side. The same issues regarding their date exist as in the case of the main NE-SW boundary, although an enclosure around Trench 28 would help explain the particular concentration of activity in this area.
- 5.2.5 Contemporary activity situated to the south-east comprised a dense concentration of both pits and postholes in Trenches 12, 17, 27 and 28. The density of activity at any one time was presumably much less, as the activity appears to have included both the late Bronze Age/early Iron Age and the

late Iron Age/early Roman periods. Recovered alongside the pottery was a considerable assemblage of fired clay. Although this includes fragments from domestic structures such as ovens and hearths, including the perforated plate in posthole 2803, there was a predominance of briquetage and evidence for salt making, including vessels for both evaporation and moulding.

- 5.2.6 It is also worth noting that nearly all the features in Trench 18, along with several features Trenches 16 and 12 were observed to have purplish grey deposits. This ash rich material is likely to be the result of salt production activities and suggests that they were taking place nearby, and probably within the site. As Land Parcel 37 is located on the edge of the gravel terrace immediately overlying the Thames floodplain, this is not unexpected; as described in section 1.4.12 above, briquetage associated with Iron Age pottery has been found around the edges of the terrace to the east and south-east. Finds from Mucking have indicated a similar use of the gravel terrace adjacent to the floodplain for salt production/processing activities (Evans *et al.* 2016).
- 5.2.7 Due to the density of features and the multi-phase occupation of the site, it has not been possible to identify any specific structures or zones of specialised activity. Residual fragments of later prehistoric pottery and briquetage fragments were recovered from Trenches 1, 2, 8, 31 and 42 but the main settlement focus was in the area of cropmarks along the south-east edge.
- 5.2.8 **Roman.** Activity on the site appears to have continued through the late Iron Age into the Roman period. As with the preceding periods of occupation, the evidence for this phase of activity was most intensively focussed on the high ground in Trenches 17, 27 and 28. Moving into the early Roman period (AD43-120), activity was also evident in Trenches 1 and 13, where some of the peripheral boundary ditches can be attributed to this period, but the main focus remains around Trenches 17 and 28.
- 5.2.9 The pottery assemblage includes both middle and late Roman sherds, but this constitutes a very small proportion of the material, which suggests that activity was on a much reduced scale. Based on the fabrics present it is possible that activity decreased as early as the last quarter of the 1st century AD. The sherd of Oxford red colour-coat ware in the upper fill of ditch 1304 is however dated AD350-410. This could possibly indicate very limited activity in the very late Roman period, but late Roman pottery is also often found, presumably reused, in Anglo-Saxon features.
- 5.2.10 Superficially, the features exposed do not indicate significant change in the nature of the activities, with Roman features comprising a variety of pits, postholes and ditches as in later prehistory. Fired clay objects including briquetage fragments continue to be found, but the fabric and forms identified suggest that these were mostly residual, implying that this was no longer a significant function of the site. Beyond some domestic activity, the finds assemblage from the evaluation is too small to determine the type of site or the status of the inhabitants with certainty, although they were evidently part of a wider trading network bringing in both regional and continental imports.

- 5.2.11 As outlined in section 1.4.13 above, significant Roman activity has been recorded around St Margaret's Road at the end of the gravel terrace 1km to the east, and a significant settlement focus at Mucking 2.5km to the north. On the western side of the dry valley, Roman sites are known at Condovers Pit, where a pottery kiln and burials were found, and at Gun Hill, where a settlement enclosure and pottery kilns were excavated (OA 2019b). The remains on this parcel indicate a further settlement with associated industrial activity, although possibly confined to the early Roman period.
- 5.2.12 **Saxon.** Following the very limited evidence for activity during the later Roman period, the site once again comes into use in the early medieval period. Unlike in preceding phases, this Anglo-Saxon activity is more widely spread across the site, with pottery recorded in Trenches 6, 7, 15, 21, 28 and 31. The features producing material of this date include ditches 603 and 705 and varying sizes of pits including 1504, 2103, 3115, 2807 and 2854.
- 5.2.13 Unfortunately, none of the larger pits dated to this period were fully exposed within the trenches. While none had the classic playing card shape, based on their shallow, flat profiles it is possible that pits 1504, 2103 and 3115 were sunken-feature buildings and, based on their appearance, possibly also pits 2912 and 1610, even though 2912 provided no dating evidence and pit 1610 only produced late Bronze Age or Roman fired clay and briquetage. The presence of residual finds in dense areas of multi-period settlement would not be surprising, and even examples with Anglo-Saxon pottery such as pit 2807 contained earlier briquetage and more than 300g of residual Roman pottery.
- 5.2.14 Due to the predominance of residual material within the Anglo-Saxon features it is difficult to determine what activities were taking place during this period. Although bone preservation has been relatively good on this site, there was no evidence for any craft activities in these possible structures and none of the loom weights, spindle whorls or bone combs often associated with such structures. It is perhaps possible that the site was again the site of salt production, but that due to the intensity of earlier activity, it was not possible to distinguish an early medieval component amongst the assemblage.
- 5.2.15 Contemporary remains have been recorded near to Land Parcel 15, 1km to the east, and some 2km distant at Mucking to the north and, on the opposite side of the dry valley at Condovers Pit to the west and Mill House Farm to the north-west (OA 2019b updated 2020). This new evidence of Anglo-Saxon settlement demonstrates that the activity was more widespread than previously known.
- 5.2.16 **Medieval.** Medieval activity (c 1100-1350) was limited to a few sherds of pottery from ditches 102, 120 and 705 and the shallow pit or ditch terminus 207. One sherd of late medieval or early post-medieval pottery was also found in Trench 1. These may indicate a focus of medieval activity in this corner of the site, but due to the very small quantities involved, and the lack of structures and other associated pits or postholes, may instead reflect a peripheral spread of finds from a settlement further to the north or north-east.

- 5.2.17 **Post-medieval.** Ditch 1206 contained a roof tile and the rim of a post-medieval storage jar (c 1680-1800). Although this ditch correlates with a distinct linear cropmark, it was not identified in Trenches 11 or 13 as might have been expected from an extrapolated alignment. There is also no correlation between ditch 1206 and any of the field boundaries mapped on the 1st edition OS map in this field.
- 5.2.18 The NW-SE aligned ditches in the Trenches 34, 35, 42 and 37, although not perfectly aligned to the mapped historic field boundaries, do run on close parallel alignments. Some, if not all of them may therefore be post-medieval field boundaries, although as the post-medieval and modern field boundaries follow the same alignments as those possibly dating from the late Bronze Age and Iron Age, this assertion needs to be treated with caution. It is alternatively possible that most or all of the ditched boundaries are of post-medieval date but incorporate residual material from an unenclosed settlement of later prehistoric and Roman date. As the cropmark ditches do not appear on historic maps, they certainly predate the mid-19th century.
- 5.2.19 **Undated Features.** A considerable number of the discrete features were not excavated during this stage of fieldwork due to the density and quantity of features present. Although efforts were made to collect surface finds, many pits, postholes and some ditches remain undated.
- 5.2.20 The excavated discrete features on the higher ground were largely indistinguishable from each other regardless of date, and so the unexcavated features may represent activity of any period from the Neolithic through to early medieval.
- 5.2.21 The unurned cremation in Trench 19 is undated but may be contemporary with the late Iron Age activity recorded close by. Although unurned cremations of this nature do occur in isolation, it is possible that others are present on the site.

### 5.3 Evaluation objectives and results

#### General Aims

- 5.3.1 **Aims i-iii.** This evaluation established the presence of archaeological remains from the middle Neolithic through to the post medieval period. It has also established that the cropmark survey had picked up a significant number of the linear features found in evaluation, but did not reflect the density of discrete features that were found. While it assisted in identifying the main focus of archaeological activity within the site, it did not reflect the full distribution of archaeological activity across the site, particularly in the northern corner.
- 5.3.2 **Aim iv.** The evaluation established the presence of colluvial sediments within the land parcel burying archaeological features. Although there was no evidence for the survival of palaeosols, the presence of colluvial sequences shows that these may exist in localised areas elsewhere within the site. It has also demonstrated a strong likelihood of deep vertical stratigraphy in the lower-lying south-west portion of the site, where trenching did not take place.

- 5.3.3 Two trenches revealed features cut into a sandy soil very similar in colour to the feature fills, which must be either a relict soil fortuitously preserved over small parts of the site, or natural where earthworm activity or chemical leaching had mixed feature fills and the matrix into which they were cut. Given the location of this soil on the highest part of the site, the former seems very unlikely, and it is probable that the very loose nature of the weathered top of the natural here had allowed material to percolate down from the overlying subsoil, and that due to the concentration of features, worm activity had also moved material from the feature fills into the natural.
- 5.3.4 **Aims v-vi.** The evaluation has established the date of the remains present, the state and preservation of the archaeological artefacts and (given the relatively small sample of the features investigated) has provided a good indication about the economy of the past inhabitants of the site, and some indications of status relative to other local sites.
- 5.3.5 **Aim vii.** Paleoenvironmental samples were recovered and have demonstrated the state of preservation and level of potential for environmental information.

#### **Site Specific Objectives**

- 5.3.6 **Aim xiii.** The evaluation was conducted within the parameters and objectives of the revised East of England Research Framework (Medlycott 2011) and takes account of the aims and objectives of the Greater Thames Estuary Historic Environment Research Framework.
- 5.3.7 **Aim xiv.** The evaluation has demonstrated that, where present, the cropmark data has been an accurate indicator for the presence of underlying remains. This is true not only for linear features but also for some of the larger discrete features that elsewhere on the LTC scheme in Essex have not been accurately represented by cropmarks. Within parcel 37, targeting of the apparently blank areas has shown that the cropmarks are restricted to areas with an underlying geology of gravel. It has also shown that whilst the cropmarks can provide an indication for an area of activity, in this case it did not indicate the density of remains that were present.
- 5.3.8 **Aim xv.** None of the trenches in parcel 37 were located near to any burial monuments of either Neolithic or Bronze Age date.
- 5.3.9 **Aim xvi.** No direct evidence for early Bronze Age activity was identified in Land Parcel 37. However, the site was occupied during the middle Neolithic and late Bronze Age periods, so it is likely that people were active in the vicinity even if they were not specifically present on this site.
- 5.3.10 **Aim xvii.** The fieldwork has indicated that much of the cropmark evidence is likely to be derived from late prehistoric activity on the site, from the late Bronze Age to the late Iron Age. The recovery of briquetage fragments and the presence of purplish deposits across certain areas of the site have shown that salt-working was probably a primary industry during the late prehistoric period on Land Parcel 37.
- 5.3.11 **Aim xviii.** The scatter of pits suggested by the cropmark data in Land Parcel 37 was only a small proportion of the remains found by trenching. Even within the limited scope of this evaluation it is evident that there are

significantly more pits than anticipated, with a density of remains that has accumulated over several phases of settlement. The earliest activity belongs to the middle Neolithic, but there is then an apparent hiatus before the first major occupation of the site from the late Bronze Age and Iron Age through to the early Roman period. The precise function of the pits is unclear, but they generally contain a combination of domestic and industrial waste. Following a break in activity through the late Roman period, a scatter of large features possibly representing sunken-featured buildings appear in the early to middle Saxon period.

- 5.3.12 Evidently the pits do represent more than one period of activity, but it is difficult to determine the proportion of features for each period due to the density of activity, the sample examined in detail and the potential residuality of dating evidence. The density of archaeological features is amongst the greatest found in any settlement found along the line of the scheme in Essex.
- 5.3.13 **Aim xix.** The limited dating evidence recovered from Land Parcel 37 indicates that medieval pottery current between AD 1100 and AD 1350 is present in several ditches in the north-east part of the site. The small quantities do not enable these features to be dated to the medieval period with confidence, as they could be residual, but potentially indicate field or enclosure boundaries of medieval date in this corner of the site. There was, however, no evidence of their connection to any medieval droveways.

## Appendix A Trench Tables

Abbreviations used in the trench tables:

FC – Fired Clay, Br – Briquetage, Fe – Iron object, CBM – Ceramic Building Material

| Trench 1  |                     |         |           |           |   |                          |                |
|---|---------------------|---------|-----------|-----------|---|--------------------------|----------------|
| General description   |                     |         |           |           | Orientation   |                          | NW-SE          |
| Trench contained three ditches and one large pit. Consists of ploughsoil and subsoil overlaying natural geology of sandy clay |                     |         |           |           | Length (m)  |                          | 30             |
|   |                     |         |           |           | Width (m)   |                          | 2.1            |
|   |                     |         |           |           | Avg. depth (m)  |                          | 0.55           |
| Context No.   | Type                | Fill Of | Width (m) | Depth (m) | Description   | Finds                    | Date           |
| 100   | Layer               |         | 2.1       | 0.22      | Ploughsoil. Mid grey brown silty sand, friable with rounded stone and grass rooting inclusions            |                          |                |
| 101   | Layer               |         | 2.1       |           | Natural. Mid orange y brown, silty sand, friable with gravel inclusions                                   |                          |                |
| 102   | Cut                 |         | 1.86      | 0.55      | Ditch. N/S  |                          |                |
| 103   | Fill                | 102     | 0.98      | 0.15      | Secondary Fill. Dark grey black sandy silt  | Pot, FC, Bone, Flint     | Med            |
| 104   | Fill                | 102     | 1.86      | 0.4       | Primary Fill. Dark brown compact sandy silt   |                          |                |
| 105   | Cut                 |         | 1.55      | 0.29      | Ditch. NE/SW  |                          |                |
| 106   | Fill                | 105     | 1.55      | 0.29      | Primary Fill. Mid greyish brown sand silt   | Lava Quern               | Roman or later |
| 107   | Cut                 |         | 0.55      | 0.09      | Ditch. NE/SE. Truncated   |                          |                |
| 108   | Fill                | 107     | 0.55      | 0.09      | Primary Fill. Light brownish grey sandy silt  | Pot                      | Roman          |
| 109   | Cut                 |         | 1.7       | 0.9       | Pit   |                          |                |
| 110   | Fill                | 120     | 2.06      | 0.72      | Secondary Fill. Mid greyish brown sandy silt  | Pot, FC, Bone, Fe, Quern | Medieval       |
| 111   | Unexcavated feature |         | 0.56      |           | Ditch. Unexcavated. Small ditch running N/S. Cuts fill of 112. Dark grey black sandy silt                 |                          |                |
| 112   | Unexcavated feature |         | 1.75      |           | Ditch. Unexcavated. Large ditch cut by 111. N/S. Mid grey brown sandy silt with orange mottling           |                          |                |
| 113   | Layer               |         |           | 0.26      | Subsoil. Mid brownish grey mod compact sandy silt   |                          |                |
| 114   | Unexcavated feature |         | 0.56      |           | Ditch. Dark grey sandy silt, slight curved linear   |                          |                |
| 115   | Fill                | 109     | 0.46      | 0.62      | Placed Deposit. redeposited backfill. Mid yellowish brown, silty clay, firm                               |                          |                |
| 116   | Fill                | 109     | 0.82      | 0.56      | Secondary Fill. Mottled mid yellowish brown and mid greyish brown, silty sand, friable                    |                          |                |
| 117   | Fill                | 109     | 1         | 0.82      | Placed Deposit. Redeposited natural, silty sand, friable with rounded stone inclusions light yellow brown |                          |                |
| 118   | Cut                 |         | 0.2       | 0.5       | Posthole  |                          |                |

LOWER THAMES CROSSING ARCHAEOLOGICAL EVALUATION REPORT LAND PARCEL 37 EAST TILBURY  
 LTC15TEV\_EVALUATION\_REPORT\_V1\_FINAL\_SL\_000121  
 DATE PUBLISHED - 03/07/2021  
 UNCONTROLLED WHEN PRINTED - COPYRIGHT © - 2020 - HIGHWAYS ENGLAND COMPANY LIMITED - ALL RIGHTS RESERVED

39



| 119   | Fill                |         | 0.2       | 0.5       | Secondary Fill. Mid brownish grey, silty clay, firm, found at western end of intersection                    |       |          |
|---|---------------------|---------|-----------|-----------|--|-------|----------|
| 120   | Cut                 |         | 2         | 0.56      | Ditch  |       |          |
| <b>Trench 2</b>   |                     |         |           |           |  |       |          |
| General description   |                     |         |           |           | Orientation  | NE-SW |          |
| Trench revealed a series of pits and 1 large ditch. Consists of ploughsoil overlaying a clay gravelly natural |                     |         |           |           | Length (m)   | 30    |          |
|   |                     |         |           |           | Width (m)  | 2.1   |          |
|   |                     |         |           |           | Avg. depth (m)   | 0.3   |          |
| Context No.   | Type                | Fill Of | Width (m) | Depth (m) | Description  | Finds | Date     |
| 200   | Layer               |         | 2.1       | 0.29      | Ploughsoil. Mid grey brown silty sand, friable with rooting and rounded stone inclusions                     |       |          |
| 201   | Layer               |         | 2.1       | 0.04      | Subsoil. Mid grey brown silty sand with fragmented flint and chalk fleck inclusions                          |       |          |
| 202   | Layer               |         | 2.1       |           | Natural. Mid reddish orange silty clay firm  |       |          |
| 203   | Cut                 |         | 0.68      | 0.17      | Ditch. Cut of potential terminus. ditch continues in a suspected south-eastern direction underneath the bulk |       |          |
| 204   | Fill                | 203     | 0.68      | 0.17      | Primary Fill. Light yellowish brown fill, of sandy clay, no finds  |       |          |
| 205   | Cut                 |         | 0.34      | 0.12      | Pit. Sub-circular in profile, with sharp concave sides and a rounded base.                                   |       |          |
| 206   | Fill                | 205     | 0.34      | 0.12      | Primary Fill. mid blackish grey sandy clay. backfilled through disuse.                                       |       |          |
| 207   | Cut                 |         | 1.46      | 0.28      | Pit. sub circular with a flat base and gradual sloping sides   |       |          |
| 208   | Fill                | 207     | 1.46      | 0.2       | Secondary Fill. suspected prehistoric pot found in its mid greyish black fill.                               | Pot   | Medieval |
| 209   | Fill                | 207     | 1.46      | 0.08      | Primary Fill. lower fill of pit, mottled dark yellowish brown sandy clay.                                    |       |          |
| 210   | Unexcavated feature |         | 3.07      |           | Ditch. Unexcavated ditch. Running NW-SE. Compact dark greyish brown, clay silt fill                          | FC    |          |
| 211   | Unexcavated feature |         | 0.5       |           | Pit. Unexcavated pit abutting terminus [203] and [205] pit. Hard dark greyish black, sandy clay fill         |       |          |
| <b>Trench 3</b>   |                     |         |           |           |  |       |          |
| General description   |                     |         |           |           | Orientation  | NW-SE |          |
| Trench devoid of archaeology. Consists of ploughsoil overlaying gravelly natural                              |                     |         |           |           | Length (m)   | 30    |          |
|   |                     |         |           |           | Width (m)  | 2.2   |          |
|   |                     |         |           |           | Avg. depth (m)   | 0.4   |          |
| Context No.   | Type                | Fill Of | Width (m) | Depth (m) | Description  | Finds | Date     |

| 300   | Layer |         | 2.1       | 0.3       | Ploughsoil. Mid grey brown silty sand, friable with rounded stone and grass rooting inclusions  |       |      |
|---|-------|---------|-----------|-----------|---|-------|------|
| 301   | Layer |         | 2.1       | 0.1       | Subsoil. Mid orangey grey silty sand with chalk and flint fleck inclusions                      |       |      |
| 302   | Layer |         | 2.1       |           | Natural. Mid reddish orange silty clay with gravel throughout                                   |       |      |
| <b>Trench 4</b>   |       |         |           |           |   |       |      |
| General description   |       |         |           |           | Orientation   | E-W   |      |
| Trench devoid of archaeology. Consists of ploughsoil overlaying natural geology of silty clay natural with gravel             |       |         |           |           | Length (m)  | 30    |      |
|   |       |         |           |           | Width (m)   | 2.1   |      |
|   |       |         |           |           | Avg. depth (m)  | 0.4   |      |
| Context No.   | Type  | Fill Of | Width (m) | Depth (m) | Description   | Finds | Date |
| 400   | Layer |         | 2.1       | 0.3       | Ploughsoil. Mid grey brown silty sand, friable with rounded stone and grass rooting inclusions  |       |      |
| 401   | Layer |         | 2.1       | 0.1       | Subsoil. Mid orangey grey with chalk And flint flecks, friable                                  |       |      |
| 402   | Layer |         | 2.1       |           | Natural. Mid orangey red silty clay, firm   |       |      |
| <b>Trench 5</b>   |       |         |           |           |   |       |      |
| General description   |       |         |           |           | Orientation   | E-W   |      |
| Trench devoid of archaeology. Consists of ploughsoil and subsoil overlaying clay natural                                      |       |         |           |           | Length (m)  | 30    |      |
|   |       |         |           |           | Width (m)   | 2.1   |      |
|   |       |         |           |           | Avg. depth (m)  | 0.73  |      |
| Context No.   | Type  | Fill Of | Width (m) | Depth (m) | Description   | Finds | Date |
| 500   | Layer |         | 2.1       | 0.4       | Ploughsoil. Mid grey brown silty sand, friable with rounded stone and grass rooting inclusions  |       |      |
| 501   | Layer |         | 2.1       | 0.3       | Subsoil. Mid orangey brown silty sand, friable with chalk flecks and pebble inclusions          |       |      |
| 502   | Layer |         | 2.1       |           | Natural. Mid reddish brown, silty sand, friable with occasional gravel inclusions               |       |      |
| <b>Trench 6</b>   |       |         |           |           |   |       |      |
| General description   |       |         |           |           | Orientation   | NE-SW |      |
| Trench revealed two pits. Consists of Ploughsoil and subsoil overlaying natural geology of brickearth with patches of gravel. |       |         |           |           | Length (m)  | 30    |      |
|   |       |         |           |           | Width (m)   | 2.3   |      |
|   |       |         |           |           | Avg. depth (m)  | 0.68  |      |
| Context No.   | Type  | Fill Of | Width (m) | Depth (m) | Description   | Finds | Date |
| 600   | Layer |         | 2.1       | 0.4       | Ploughsoil. Mid grey brown, silty sand, friable with rounded stone and grass rooting inclusions |       |      |
| 601   | Layer |         | 2.3       | 0.3       | Subsoil. Light brownish grey silty sand.  |       |      |

|     |                     |     |      |     |   |     |    |
|-----|---------------------|-----|------|-----|---|-----|----|
| 602 | Layer               |     | 2.1  |     | Natural. Mid orangey brown sandy silt with outcrops of gravel.            |     |    |
| 603 | Cut                 |     | 0.95 | 0.1 | Pit. Elongated in plan, with moderate sloping sides and flat base.        |     |    |
| 604 | Fill                | 603 | 0.95 | 0.1 | Secondary Fill. Mid greyish brown sandy silt.                             | Pot | AS |
| 605 | Unexcavated feature |     | 0.4  |     | Pit. Circular in plan, not tested.  |     |    |
| 606 | Unexcavated feature |     | 0.2  |     | Plough Furrow. Narrow linear feature, probably a plough mark. Not tested. |     |    |

#### Trench 7

|  |  |  |  |  |                |       |
|--|--|--|--|--|----------------|-------|
| General description  |  |  |  |  | Orientation    | NW-SE |
| Trench contains one pit, and two possible ditches. Consists of ploughsoil and subsoil overlaying clayed gravelly natural |  |  |  |  | Length (m)     | 30    |
|  |  |  |  |  | Width (m)      | 2.1   |
|  |  |  |  |  | Avg. depth (m) | 0.5   |

| Context No. | Type  | Fill Of | Width (m) | Depth (m) | Description                           | Finds     | Date     |
|-------------|-------|---------|-----------|-----------|---------------------------------------|-----------|----------|
| 700         | Layer |         |           | 0.2       | Ploughsoil. Mid grey brown silty sand |           |          |
| 701         | Layer |         |           | 0.32      | Subsoil. Mid orange grey silty clay   |           |          |
| 702         | Layer |         |           |           | Natural                               |           |          |
| 703         | Cut   |         | 0.55      | 0.07      | Pit                                   |           |          |
| 704         | Fill  | 703     | 0.55      | 0.07      | Primary Fill                          |           |          |
| 705         | Cut   |         | 0.49      | 0.2       | Ditch                                 |           |          |
| 706         | Fill  | 705     | 0.49      | 0.2       | Primary Fill                          | Pot, Bone | Medieval |
| 707         | Cut   |         | 0.4       | 0.05      | Ditch                                 |           |          |
| 708         | Fill  | 707     | 0.4       | 0.05      | Primary Fill                          |           |          |

#### Trench 8

|  |  |  |  |  |                |       |
|--|--|--|--|--|----------------|-------|
| General description  |  |  |  |  | Orientation    | NE-SW |
| One possible trackway, and two smaller ditches visible. Consists of ploughsoil and subsoil overlaying natural geology of silty clay. |  |  |  |  | Length (m)     | 30    |
|  |  |  |  |  | Width (m)      | 2.1   |
|  |  |  |  |  | Avg. depth (m) | 0.6   |

| Context No. | Type                | Fill Of | Width (m) | Depth (m) | Description  | Finds | Date  |
|-------------|---------------------|---------|-----------|-----------|--|-------|-------|
| 800         | Layer               |         |           | 0.3       | Ploughsoil. Mid grey brown, silty sand, friable  |       |       |
| 801         | Layer               |         |           | 0.2       | Subsoil. Light brownish grey, silty sand, friable. More prominent in northern half of trench |       |       |
| 802         | Layer               |         |           |           | Natural. Mid red orange, silty clay with gravel, friable                                     |       |       |
| 803         | Cut                 |         | 2.73      | 0.31      | Ditch  |       |       |
| 804         | Fill                | 803     | 2.34      | 0.13      | Primary Fill. Mid greyish brown sandy silt   | CBM   | PM    |
| 805         | Unexcavated feature |         | 0.65      |           | Ditch. Linear N-S. Light brown grey sandy silt, friable                                      |       |       |
| 806         | Unexcavated feature |         | 0.57      |           | Ditch. Linear N-S. Light grey brown sandy silt, friable                                      | Pot   | Roman |

|     |      |     |      |      |   |     |        |
|-----|------|-----|------|------|---|-----|--------|
| 807 | Fill | 803 | 2.73 | 0.23 | Primary Fill. Dark brown, silty sand, moderately compact  | Pot | MBA/IA |
| 808 | Cut  |     | 1.6  | 0.6  | Ditch   |     |        |
| 809 | Fill | 808 | 1.6  | 0.6  | Secondary Fill. single fill of ditch, no finds, mid reddish brown fill with medium rounded pebbled inclusions |     |        |
| 810 | Void |     |      |      |   |     |        |

#### Trench 9

|   |  |  |  |  |                |       |
|---|--|--|--|--|----------------|-------|
| General description   |  |  |  |  | Orientation    | NW-SE |
| Trench contains one possible ditch terminus, and one natural feature. Consists of ploughsoil overlaying natural geology of silty clay with gravel |  |  |  |  | Length (m)     | 30    |
|   |  |  |  |  | Width (m)      | 2.1   |
|   |  |  |  |  | Avg. depth (m) | 0.3   |

| Context No. | Type  | Fill Of | Width (m) | Depth (m) | Description   | Finds | Date |
|-------------|-------|---------|-----------|-----------|---|-------|------|
| 900         | Layer |         | 2.1       | 0.4       | Ploughsoil. Mid grey brown, silty sand, friable with rounded stone and grass rooting inclusions |       |      |
| 901         | Layer |         | 2.1       |           | Natural. Mid red brown silty clay with the occasional gravel patches.                           |       |      |
| 902         | Cut   |         | 0.4       | 0.3       | Ditch. Possible terminus found at north-western edge of the trench                              |       |      |
| 903         | Fill  | 902     | 0.4       | 0.3       | Secondary Fill. Light yellowy brown. Silty sand, rounded stone and animal bone inclusions       |       |      |
| 904         | Cut   |         | 1.25      | 0.3       | Natural Feature. Gravel patch in otherwise clay trench  | Bone  |      |
| 905         | Cut   |         | 1         | 0.46      | Ditch   |       |      |
| 906         | Fill  | 905     | 1         | 0.46      | Primary Fill. Dark grey sandy silt  |       |      |
| 907         | Cut   |         | 0.64      | 0.5       | Ditch   |       |      |
| 908         | Fill  | 907     | 0.64      | 0.5       | Primary Fill. Dark grey sandy silt.   |       |      |

#### Trench 10

|  |  |  |  |  |                |      |
|--|--|--|--|--|----------------|------|
| General description  |  |  |  |  | Orientation    | N-S  |
| Trench devoid of archaeology. Consists of Ploughsoil and colluvium overlaying natural geology and gravel and silty sand. |  |  |  |  | Length (m)     | 30   |
|  |  |  |  |  | Width (m)      | 2.3  |
|  |  |  |  |  | Avg. depth (m) | 0.55 |

| Context No. | Type  | Fill Of | Width (m) | Depth (m) | Description   | Finds | Date |
|-------------|-------|---------|-----------|-----------|---|-------|------|
| 1000        | Layer |         |           | 0.3       | Ploughsoil. Mid grey brown, sandy silt with frequent gravel.  |       |      |
| 1001        | Layer |         | 2.1       | 0.3       | Colluvial Layer. Mid greyish brown sandy silt with frequent gravel.   |       |      |
| 1002        | Layer |         | 2.1       |           | Natural. Varies across the trench. Silty sand, gravel and brickearth.   |       |      |
| 1003        | Cut   |         | 0.65      | 0.1       | Natural Feature. Oval feature investigated, most likely a remnant of colluvium into a natural depression.     |       |      |
| 1004        | Cut   |         | 0.4       | 0.05      | Natural Feature. Circular feature investigated, most likely a remnant of colluvium into a natural depression. |       |      |

| 1005  | Cut                 |         | 0.35      | 0.08      | Other Cut. Narrow linear feature investigated. Most likely a plough scar.                       |                   |             |
|---|---------------------|---------|-----------|-----------|---|-------------------|-------------|
| <b>Trench 11</b>  |                     |         |           |           |   |                   |             |
| General description   |                     |         |           |           | Orientation   |                   | E-W         |
| Trench contains one ditch at eastern end uncovered. Consists of Ploughsoil and subsoil overlaying gravelly natural                                |                     |         |           |           | Length (m)  |                   | 30          |
|   |                     |         |           |           | Width (m)   |                   | 2.1         |
|   |                     |         |           |           | Avg. depth (m)  |                   | 0.5         |
| Context No.   | Type                | Fill Of | Width (m) | Depth (m) | Description   | Finds             | Date        |
| 1100  | Layer               |         | 2.1       |           | Ploughsoil. Mid grey brown, silty sand, friable with rounded stone and grass rooting inclusions |                   |             |
| 1101  | Layer               |         | 2.1       | 0.18      | Subsoil. Mid orange brown, silty clay, hard   |                   |             |
| 1102  | Layer               |         | 2.1       | 0.43      | Natural. Light brownish yellow, sandy clay with patches of gravel                               |                   |             |
| 1103  | Layer               |         |           |           | Natural. change in natural to light yellowish brown sandy silt                                  |                   |             |
| 1104  | Cut                 |         | 0.62      | 0.12      | Ditch. Linear ditch running NE-SW across E end of the ditch                                     |                   |             |
| 1105  | Fill                | 1104    | 0.62      | 0.14      | Secondary Fill. Light greyish brown silty clay  |                   |             |
| <b>Trench 12</b>  |                     |         |           |           |   |                   |             |
| General description   |                     |         |           |           | Orientation   |                   | NE-SW       |
| Trench contains 9 pits and 3 ditches present, 3 pits excavated, inc. Consists of ploughsoil overlaying natural geology of silty clay with gravel. |                     |         |           |           | Length (m)  |                   | 30          |
|   |                     |         |           |           | Width (m)   |                   | 2.1         |
|   |                     |         |           |           | Avg. depth (m)  |                   | 0.3         |
| Context No.   | Type                | Fill Of | Width (m) | Depth (m) | Description   | Finds             | Date        |
| 1200  | Layer               |         | 2.1       | 0.38      | Ploughsoil. Mid grey brown, silty sand, friable with rounded stone and grass rooting inclusions |                   |             |
| 1201  | Layer               |         | 2.1       | 0.08      | Natural. mid orange brown silty sand and gravel   |                   |             |
| 1202  | Cut                 |         | 1.04      | 0.34      | Pit. mid size pit at SE end of the trench.  |                   |             |
| 1203  | Fill                | 1202    | 1.04      | 0.34      | Secondary Fill. Single fill, dark greyish brown silty sand                                      | FC, Pot, Bone, Fe | LBA/EIA S.1 |
| 1204  | Cut                 |         | 0.52      | 0.14      | Pit. small pit in centre of trench  |                   |             |
| 1205  | Fill                | 1204    | 0.52      | 0.14      | Secondary Fill. dark greyish brown silty sand   | FC                |             |
| 1206  | Cut                 |         | 1.08      | 0.4       | Ditch. post med. Ditch at NE end of the trench.   |                   |             |
| 1207  | Fill                | 1206    | 1.08      | 0.4       | Secondary Fill. light greyish brown silty sand, frequent rounded stone inclusions               | Pot, CBM          | PM          |
| 1208  | Unexcavated feature |         | 0.65      |           | Ditch. E/W orientated, containing a dark brown sandy silt fill.                                 | Pot               | Prehistoric |
| 1209  | Unexcavated feature |         | 0.48      |           | Pit. small pit, dark greyish brown silty sand   | Pot               | MBA/IA      |

|      |                     |      |      |     |  |         |     |
|------|---------------------|------|------|-----|--|---------|-----|
| 1210 | Unexcavated feature |      | 3    |     | Pit. Large pit, possibly structural, dark greyish brown silty sand, extends beyond trench. | FC, Pot | EIA |
| 1211 | Unexcavated feature |      | 0.46 |     | Pit. Small pit, dark greyish brown silty sand  |         |     |
| 1212 | Unexcavated feature |      | 0.54 |     | Ditch. Small linear at NE end of trench runs NW-SE   |         |     |
| 1213 | Unexcavated feature |      | 3.72 |     | Ditch. large linear at NE end, runs ENE- WSW, relationship with two smaller ditches        | Bone    |     |
| 1214 | Unexcavated feature |      | 0.95 |     | Pit. Sub-oval in plan. Seems to be truncated by ditch 1208.                                |         |     |
| 1215 | Unexcavated feature |      | 0.68 |     | Pit. Oval in plan, containing a dark brown sandy silt fill.                                |         |     |
| 1216 | Unexcavated feature |      | 0.52 |     | Pit. Circular in plan, containing a dark brown sandy silt fill.                            |         |     |
| 1217 | Cut                 |      | 0.6  | 0.1 | Pit  |         |     |
| 1218 | Fill                | 1217 | 0.6  | 0.1 | Secondary Fill. dark purplish brown silty sand, clay inclusions                            | FC      |     |

### Trench 13

|   |  |                |       |
|---|--|----------------|-------|
| General description   |  | Orientation    | NW-SE |
| Trench contains several linear ditches and several small pits or postholes. Consists of ploughsoil overlaying gravelly natural. |  | Length (m)     | 30    |
|   |  | Width (m)      | 2.1   |
|   |  | Avg. depth (m) | 0.3   |

| Context No. | Type                | Fill Of | Width (m) | Depth (m) | Description   | Finds            | Date  |
|-------------|---------------------|---------|-----------|-----------|---|------------------|-------|
| 1300        | Layer               |         | 2.1       | 0.34      | Ploughsoil. Mid grey brown, silty sand, friable with rounded stone and grass rooting inclusions |                  |       |
| 1301        | Layer               |         |           |           | Natural. Mid orange brown, clay sand, moderately compact  |                  |       |
| 1302        | Cut                 |         | 0.99      | 0.14      | Ditch. Possible enclosure ditch, NE-SW running  |                  |       |
| 1303        | Fill                |         | 0.99      | 0.14      | Primary Fill. Dark grey brown, moderately compact, sandy silt                                   |                  |       |
| 1304        | Cut                 |         | 3.53      |           | Ditch. NW/SE  |                  |       |
| 1305        | Fill                | 1304    | 3.53      |           | Primary Fill. Stony dark grey mod compact sandy silt  | Pot, Bone, Flint | Roman |
| 1306        | Cut                 |         | 1.31      | 0.52      | Ditch. Runs NW/SE   |                  |       |
| 1307        | Fill                | 1306    | 1.31      | 0.52      | Primary Fill. Light grey loose sandy silt   |                  |       |
| 1308        | Unexcavated feature |         | 1.68      |           | Ditch. Unexcavated. N/S. Dark grey compact sandy silt   |                  |       |
| 1309        | Cut                 |         | 0.4       | 0.04      | Plough Furrow. Plough scar  |                  |       |
| 1310        | Unexcavated feature |         | 1.16      |           | Ditch. Dark grey sandy silt   |                  |       |
| 1311        | Cut                 |         | 0.7       | 0.38      | Pit   |                  |       |
| 1312        | Fill                | 1311    | 0.7       | 0.38      | Primary Fill. Dark greyish brown mod compact sandy silt   | FC, Flint        |       |
| 1313        | Unexcavated feature |         | 0.3       |           | Posthole. Circular in plan, containing a dark brownish grey silty sand fill.                    |                  |       |
| 1314        | Unexcavated feature |         | 0.6       |           | Ditch. N/S orientated, containing a mid greyish brown sandy silt fill.                          |                  |       |

| 1315   | Unexcavated feature |         | 0.5       |           | Posthole. Circular in plan, containing a dark brownish grey sandy silt fill.                    |              |      |
|--|---------------------|---------|-----------|-----------|---|--------------|------|
| 1316   | Unexcavated feature |         | 0.6       |           | Posthole. Circular in plan, containing a dark brown sandy silt fill.                            |              |      |
| 1317   | Unexcavated feature |         | 0.95      |           | Pit. Dark grey brown sandy silt. pit or ditch terminus.   |              |      |
| <b>Trench 14</b>   |                     |         |           |           |   |              |      |
| General description  |                     |         |           |           | Orientation   | NE-SW        |      |
| Trench devoid of archaeology. Consists of Ploughsoil overlaying clayish gravelly natural   |                     |         |           |           | Length (m)  | 30           |      |
|  |                     |         |           |           | Width (m)   | 2.1          |      |
|  |                     |         |           |           | Avg. depth (m)  | 0.6          |      |
| Context No.  | Type                | Fill Of | Width (m) | Depth (m) | Description   | Finds        | Date |
| 1400   | Layer               |         | 2.1       | 0.4       | Ploughsoil. Mid grey brown, silty sand, friable with rounded stone and grass rooting inclusions |              |      |
| 1401   | Layer               |         | 2.1       |           | Natural. Mid red orange silty clay with gravel patches  |              |      |
| <b>Trench 15</b>   |                     |         |           |           |   |              |      |
| General description  |                     |         |           |           | Orientation   | NW-SE        |      |
| Trench revealed a possible sunken-feature building and a small pit at the south-east of the trench. Consists of ploughsoil, subsoil and colluvium overlaying a silty gravelly natural. |                     |         |           |           | Length (m)  | 30           |      |
|  |                     |         |           |           | Width (m)   | 2.1          |      |
|  |                     |         |           |           | Avg. depth (m)  | 0.75         |      |
| Context No.  | Type                | Fill Of | Width (m) | Depth (m) | Description   | Finds        | Date |
| 1500   | Layer               |         |           | 0.36      | Ploughsoil. Mid grey brown, silty sand, friable   |              |      |
| 1501   | Layer               |         |           | 0.3       | Subsoil. Dark brown grey, sandy silt, friable   |              |      |
| 1502   | Layer               |         |           | 0.24      | Colluvial Layer. Light grey, silty sand, loose  |              |      |
| 1503   | Layer               |         |           |           | Natural. Mid brown orange, sandy gravel, friable  |              |      |
| 1504   | Cut                 |         | 2.62      | 0.38      | Pit. Sub circular feature, possible SFB   |              |      |
| 1505   | Fill                | 1504    | 0.93      | 0.25      | Primary Fill. Dark brown grey, sandy silt, moderately compact                                   | Pot, FC, CBM | AS   |
| 1506   | Fill                | 1504    | 2.45      | 0.12      | Secondary Fill. Dark brown, sandy silt, moderately compact                                      |              |      |
| 1507   | Unexcavated feature |         | 0.69      |           | Pit. Circular in plan. Light grey brown, sandy silt, loose                                      |              |      |
| <b>Trench 16</b>   |                     |         |           |           |   |              |      |
| General description  |                     |         |           |           | Orientation   | NW-SE        |      |
| Trench contains of three ditches, two pits and a possible structural cut.. Consists of Ploughsoil, overlaying natural geology of gravel and orange silty sand.                         |                     |         |           |           | Length (m)  | 30           |      |
|  |                     |         |           |           | Width (m)   | 2.3          |      |
|  |                     |         |           |           | Avg. depth (m)  | 0.61         |      |
| Context No.  | Type                | Fill Of | Width (m) | Depth (m) | Description   | Finds        | Date |

|      |                     |      |      |      |  |                            |        |
|------|---------------------|------|------|------|--|----------------------------|--------|
| 1600 | Layer               |      |      | 0.33 | Ploughsoil. Mid brown grey, silty clay, friable  |                            |        |
| 1601 | Layer               |      |      | 0.19 | Subsoil. Dark grey brown, silty sand, friable  |                            |        |
| 1602 | Layer               |      |      |      | Natural. Mid brown orange, silty sand, friable, frequent gravel inclusions                                     |                            |        |
| 1603 | Cut                 |      | 0.3  | 0.1  | Posthole. Cut of possible post hole  |                            |        |
| 1604 | Fill                | 1603 | 0.3  | 0.1  | Primary Fill. dark greyish brown, sandy silt   |                            |        |
| 1605 | Cut                 |      | 1.85 | 0.59 | Ditch. possible field boundary SW/NE Running   |                            |        |
| 1606 | Fill                | 1605 | 1.85 | 0.59 | Primary Fill. dark grey brown sandy silt, friable  | Br, Pot, Bone, Tile, ABone | IA     |
| 1607 | Cut                 |      | 0.5  | 0.12 | Ditch. possible gully running NE/SW with terminates within the trench, continues into the NE bulk              |                            |        |
| 1608 | Fill                | 1607 | 0.5  | 0.12 | Primary Fill. mid greyish brown, silty sand, undated   |                            |        |
| 1609 | Fill                | 1605 | 0.7  | 0.23 | Primary Fill. lower fill of ditch, dark greyish brown, sandy silt, flecks of CBM seen but not kept due to size |                            |        |
| 1610 | Cut                 |      | 2.6  | 0.45 | Pit. square in plan, possible sfb located at SE end of trench  |                            |        |
| 1611 | Fill                | 1610 | 2.6  | 0.45 | Primary Fill. Dark purplish greyish brown, sandy silt, bone, pot and CBM found                                 | Br, Bone                   | LBA-RB |
| 1612 | Cut                 | 1612 | 1.72 | 0.38 | Ditch. Dark, purplish greyish, brown, silty sand with frequent gravel.   |                            |        |
| 1613 | Unexcavated feature |      | 0.6  | 0.27 | Ditch. NE/SW orientated shallow ditch visible in section. Completely truncated by machine.                     |                            |        |
| 1614 | Fill                | 1612 | 2.22 | 0.38 | Secondary Fill. not fully excavated, over machined, rec in plan  |                            |        |

#### Trench 17

|   |  |                |       |
|---|--|----------------|-------|
| General description   |  | Orientation    | NE-SW |
| Trench contains twenty-eight pits and six ditches. Consists of ploughsoil and a potential occupation layer overlaying natural geology of silty sand with gravel |  | Length (m)     | 30    |
|   |  | Width (m)      | 2     |
|   |  | Avg. depth (m) | 0.58  |

| Context No. | Type  | Fill Of | Width (m) | Depth (m) | Description  | Finds         | Date   |
|-------------|-------|---------|-----------|-----------|--|---------------|--------|
| 1700        | Layer |         |           | 0.31      | Ploughsoil. Mid brown grey, silty clay, friable  |               |        |
| 1701        | Layer |         |           | 0.4       | Other Layer. Mid brown, silty sand, loose, frequent gravel. Overlain by subsoil and cut by features, this layer sealed the natural geology. Its origins are uncertain. |               |        |
| 1702        | Cut   |         | 0.68      | 0.18      | Pit  |               |        |
| 1703        | Fill  | 1702    | 0.68      | 0.18      | Secondary Fill. Dark brown grey, silty sand, friable   | Br, Pot, Bone | LIA/ER |
| 1704        | Cut   |         | 1.24      | 0.6       | Pit. steep sides and concave base, mostly identified in section  |               |        |



|      |                     |      |      |      |   |               |         |
|------|---------------------|------|------|------|---|---------------|---------|
| 1705 | Fill                | 1704 | 0.82 | 0.18 | Deliberate Backfill. Mid yellow grey, sandy clay, friable           |               |         |
| 1706 | Fill                | 1704 | 1.24 | 0.42 | Deliberate Backfill. Dark brown grey, silty sand, friable           | Br, Pot       | LBA/EIA |
| 1707 | Cut                 |      | 0.86 | 0.5  | Pit. Only seen in section   |               |         |
| 1708 | Fill                | 1707 | 0.86 | 0.5  | Deliberate Backfill. Dark brown grey, silty sand, friable           | Br, Pot, Bone | MBA/IA  |
| 1709 | Cut                 |      | 0.84 | 0.54 | Pit. Only seen in section   |               |         |
| 1710 | Fill                | 1709 | 0.84 | 0.54 | Secondary Fill. Mid grey brown, silty sand, friable                 | Br, Pot, Bone | Neo     |
| 1711 | Unexcavated feature |      | 0.59 |      | Pit. Circular in plan. Dark brown grey, silty sand, friable         |               |         |
| 1712 | Unexcavated feature |      | 0.67 |      | Pit. Circular in plan. Mid grey brown, silty sand, friable          | Br, Pot       | MBA/IA  |
| 1713 | Unexcavated feature |      | 0.49 |      | Pit. Circular in plan. Dark brown grey, silty sand, friable         |               |         |
| 1714 | Unexcavated feature |      | 0.62 |      | Pit. Circular in plan. Dark brown grey, silty sand, friable         | Pot           | LIA/ER  |
| 1715 | Unexcavated feature |      | 0.45 |      | Pit. Circular in plan. Dark brown grey, silty sand, friable         |               |         |
| 1716 | Unexcavated feature |      | 0.29 |      | Pit. Circular in plan. Mid brown grey, silty sand, friable          | Pot, Bone     | MBA/IA  |
| 1717 | Cut                 |      | 0.88 | 0.4  | Pit. Only seen in section   |               |         |
| 1718 | Fill                | 1717 | 0.88 | 0.4  | Secondary Fill. Mid brown grey, silty sand, friable                 | Pot           | MBA/IA  |
| 1719 | Unexcavated feature |      | 0.39 |      | Pit. Circular in plan. Dark brown grey, silty sand, friable         |               |         |
| 1720 | Unexcavated feature |      | 0.33 |      | Pit. Circular in plan. Mid grey brown, silty sand, friable          |               |         |
| 1721 | Unexcavated feature |      | 1.19 |      | Pit. Oval in plan. Mid brown grey, silty sand, friable              |               |         |
| 1722 | Unexcavated feature |      | 0.61 |      | Pit. Oval in plan. Mid brown grey, silty sand, friable              |               |         |
| 1723 | Unexcavated feature |      | 0.86 |      | Ditch. Terminus running NW-SE. Dark brown grey, silty sand, friable |               |         |
| 1724 | Unexcavated feature |      | 0.72 |      | Pit. Circular in plan. Dark brown grey, silty sand, friable         |               |         |
| 1725 | Unexcavated feature |      | 0.25 |      | Posthole. Circular in plan. Dark brown grey, silty sand, friable    |               |         |
| 1726 | Unexcavated feature |      | 0.42 |      | Tree Throw. Irregular shape. Mid brown grey, silty sand, friable    |               |         |
| 1727 | Unexcavated feature |      | 0.41 |      | Ditch. Linear NW-SE. Mid brown grey, silty sand, friable            |               |         |
| 1728 | Unexcavated feature |      | 2.32 |      | Ditch. Linear NE-SW. Dark brown grey, silty sand, friable           | Bone          |         |
| 1729 | Unexcavated feature |      | 0.98 |      | Ditch. Linear NW-SE. Fill is a mid grey brown, silty sand, friable. | Pot           | MBA/IA  |
| 1730 | Cut                 |      | 1.68 | 0.7  | Pit   |               |         |
| 1731 | Fill                | 1730 | 1.68 | 0.7  | Deliberate Backfill. Mid brown grey, silty sand, friable            | Br, Pot, Bone | Roman   |
| 1732 | Unexcavated feature |      | 0.65 |      | Pit. Circular in plan. Light grey brown, silty sand, friable        |               |         |
| 1733 | Unexcavated feature |      | 1.73 |      | Pit. Oval in plan. Mid brown grey, silty sand, friable              |               |         |
| 1734 | Unexcavated feature |      | 0.33 |      | Pit. Circular in plan. Dark grey brown, silty sand, friable         |               |         |
| 1735 | Unexcavated feature |      | 0.39 |      | Pit. Circular in plan. Mid brown grey, silty sand, friable          |               |         |

|      |                     |      |      |      |  |      |         |
|------|---------------------|------|------|------|--|------|---------|
| 1736 | Unexcavated feature |      | 0.31 |      | Pit. Circular in plan. Mid brown grey, silty sand, friable                   |      |         |
| 1737 | Unexcavated feature |      | 0.37 |      | Pit. Circular in plan. Mid brown grey, silty sand, friable                   |      |         |
| 1738 | Unexcavated feature |      | 0.41 |      | Pit. Circular in plan. Dark brown grey, silty sand, friable                  |      |         |
| 1739 | Unexcavated feature |      | 0.51 | 0.26 | Pit. Only seen in section. Mid brown grey, silty sand, friable               | Bone |         |
| 1740 | Unexcavated feature |      | 0.5  |      | Pit. Circular in plan. Dark brown grey, silty sand, friable                  |      |         |
| 1741 | Unexcavated feature |      | 0.28 |      | Ditch. Small linear running NE-SW. Light brown grey, silty sand, friable     |      |         |
| 1742 | Unexcavated feature |      | 0.32 |      | Posthole. Circular in plan. Dark brown grey, silty sand, friable             |      |         |
| 1743 | Unexcavated feature |      | 0.44 |      | Pit. Circular in plan. Mid brown grey, silty sand, friable                   |      |         |
| 1744 | Unexcavated feature |      | 1.11 |      | Ditch. Terminus running E-W. Dark brown grey, silty sand, friable            |      |         |
| 1745 | Layer               |      | 30   | 0.18 | Subsoil. Dark grey brown, silty sand, friable, frequent gravel inclusions    |      |         |
| 1746 | Cut                 |      | 1.2  | 0.32 | Pit. Not bottomed. Recorded in section.                                      |      |         |
| 1747 | Fill                | 1746 | 0.88 | 0.11 | Primary Fill. Mid brown grey, sandy silt, frequent white flecks, rare stones |      |         |
| 1748 | Fill                | 1746 | 0.88 | 0.14 | Secondary Fill. Dark brown grey, silty loam, frequent stones                 | Pot  | LBA/EIA |
| 1749 | Layer               |      |      |      | Natural. Mid to light orange brown, sandy gravel.                            |      |         |

#### Trench 18

|  |  |                |       |
|--|--|----------------|-------|
| General description  |  | Orientation    | NW-SE |
| Trench contains Five ditches, three pits, 2 postholes. Consists of ploughsoil and subsoil overlaying natural geology of silty sand |  | Length (m)     | 30    |
|  |  | Width (m)      | 2     |
|  |  | Avg. depth (m) | 0.57  |

| Context No. | Type  | Fill Of | Width (m) | Depth (m) | Description   | Finds | Date |
|-------------|-------|---------|-----------|-----------|---|-------|------|
| 1800        | Layer |         |           | 0.35      | Ploughsoil. Mid grey brown, silty clay, friable   |       |      |
| 1801        | Layer |         |           | 0.2       | Subsoil. Dark grey brown, silty sand, loose   |       |      |
| 1802        | Layer |         |           |           | Natural. Mid brown orange, silty sand, loose, frequent gravel inclusions  |       |      |
| 1803        | Cut   |         | 1.1       |           | Ditch. Unexcavated because the ditch has already been recorded as [1605] in TR. 16 to the N/E. Ditch runs N/E-S/W through trench. Fill is same as (1606) and is a dark purplish grey brown sandy silt with frequent gravel. |       |      |
| 1804        | Cut   |         | 0.8       | 0.55      | Ditch. Possible boundary ditch running SW/NE through the trench. Concave and convex eiders (slightly stepped, with a concave base   |       |      |

|      |                     |      |      |      |   |                          |              |
|------|---------------------|------|------|------|---|--------------------------|--------------|
| 1805 | Fill                | 1804 | 0.8  | 0.55 | Primary Fill. Dark purplish brown, sandy silt, compact, CBM inclusions  | FC, CBM                  |              |
| 1806 | Cut                 |      | 0.75 | 0.5  | Ditch. SW/NE running similar profile to ditch [1804]  |                          |              |
| 1807 | Fill                | 1806 | 0.75 | 0.5  | Primary Fill. Compact, dark purplish grey fill with CBM inclusions  | FC                       | IA-Roman     |
| 1808 | Cut                 |      | 1.8  | 0.75 | Ditch. possible boundary ditch running NE/SW across the trench with steep edges and an unknown base. (feature continues beyond a metre) |                          |              |
| 1809 | Fill                | 1808 | 2.5  | 0.58 | Primary Fill. upper fill of ditch, dark greyish brown, moderately firm  |                          |              |
| 1810 | Fill                | 1808 | 1.8  | 0.75 | Primary Fill. dark purplish grey brown, moderately compact. sandy silt with bone flint and CBM inclusions                               | Br, CBM, FC, Bone, Flint | IA-Roman S.2 |
| 1811 | Cut                 |      | 0.45 | 0.13 | Posthole. flat base, with steep sloping sides   |                          |              |
| 1812 | Fill                | 1811 | 0.45 | 0.13 | Primary Fill. dark purplish brown, sandy silt   |                          |              |
| 1813 | Cut                 |      | 0.5  | 0.17 | Posthole. sharp steep sides with a concave base   |                          |              |
| 1814 | Fill                | 1813 | 0.5  | 0.17 | Primary Fill. dark purplish greyish brown, sandy silt   |                          |              |
| 1815 | Cut                 |      | 0.2  | 0.1  | Posthole. sharp bos with steep sides and a concave base   |                          |              |
| 1816 | Fill                | 1815 | 0.2  | 0.1  | Primary Fill. dark purplish grey brown, sandy silt  |                          |              |
| 1817 | Unexcavated feature |      | 0.75 |      | Pit. Pit is located towards the N/W end of tr. 18. Fill of pit is a greyish brown, sandy silt, frequent gravel.                         |                          |              |
| 1818 | Unexcavated feature |      | 0.83 |      | Pit. Pit located at the S/E end of tr. 18. Fill is a greyish brown sandy silt, frequent gravel.   |                          |              |
| 1819 | Cut                 |      | 0.7  | 0.27 | Ditch. terminus, running north into the bulk  |                          |              |
| 1820 | Fill                | 1819 | 0.7  | 0.27 | Primary fill. dark purplish grey brown, sandy silt  |                          |              |
| 1821 | Cut                 |      | 0.97 | 0.28 | Pit. pit seen in section. Steep sloping sides and concave base  |                          |              |
| 1822 | Fill                | 1821 | 0.97 | 0.28 | Primary fill. dark purplish grey brown, sandy silt, with pot, bone and flint amongst the inclusions                                     | Pot, Bone, Flint         | LIA/ER       |
| 1823 | Unexcavated feature |      | 0.85 |      | Ditch. Ditch located at the N/W end of tr. 18. Fill is a dark purplish grey brown, sandy silt with frequent gravel.                     |                          |              |
| 1824 | Cut                 |      | 1.15 | 0.65 | Ditch. steep sloping sides with a concave base, runs NE-SW possible boundary ditch  |                          |              |
| 1825 | Fill                | 1824 | 1.15 | 0.8  | Primary Fill. dark purplish grey brown, sandy silt.   |                          |              |

**Trench 19**

|                     |             |       |
|---------------------|-------------|-------|
| General description | Orientation | NE-SW |
|                     | Length (m)  | 30    |
|                     | Width (m)   | 2.3   |

| One cremation pit revealed in the south-western end of the trench. Consists of Ploughsoil and colluvium overlying natural geology of gravel with occasional patches of greyish brown silty sand. |                     |         |           |           | Avg. depth (m)  | 1     |      |
|--|---------------------|---------|-----------|-----------|---|-------|------|
| Context No.  | Type                | Fill Of | Width (m) | Depth (m) | Description   | Finds | Date |
| 1900   | Layer               |         | 2.1       | 0.3       | Ploughsoil. Mid greyish brown, sandy silt.  |       |      |
| 1901   | Layer               |         |           | 0.54      | Colluvial Layer. Light greyish brown sandy silt with frequent gravel and pebbles.   |       |      |
| 1902   | Layer               |         |           |           | Natural. Gravel with patches of light greyish brown silty sand.   |       |      |
| 1903   | Unexcavated feature |         | 0.37      |           | Cremation Cut. Circular in plan containing a dark black fill with frequent charcoal and cremated bone. Left unexcavated due to depth of trench. |       |      |
| 1904   | Layer               |         | 0.4       | 0.45      | Other Layer. Dark brown grey sandy silt   |       |      |

#### Trench 20

|   |  |                |       |
|---|--|----------------|-------|
| General description   |  | Orientation    | NW-SE |
| Trench devoid of archaeology. Consists of Ploughsoil and subsoil overlying clayed natural |  | Length (m)     | 30    |
|   |  | Width (m)      | 2.1   |
|   |  | Avg. depth (m) | 0.6   |

| Context No. | Type  | Fill Of | Width (m) | Depth (m) | Description   | Finds | Date |
|-------------|-------|---------|-----------|-----------|---|-------|------|
| 2000        | Layer |         | 2.1       | 0.32      | Ploughsoil. Mid grey brown, silty sand, friable with rounded stone and grass rooting inclusions |       |      |
| 2001        | Layer |         | 2.1       | 0.12      | Subsoil. Mid grey orangey brown with chalk and flint inclusions, friable                        |       |      |
| 2002        | Layer |         | 2.1       |           | Natural. Mid orangey brown silty clay, firm with flint inclusions                               |       |      |

#### Trench 21

|  |  |                |     |
|--|--|----------------|-----|
| General description  |  | Orientation    | E-W |
| Trench revealed two ditches. Consists of Ploughsoil and subsoil overlying natural geology of gravel. |  | Length (m)     | 30  |
|  |  | Width (m)      | 2.1 |
|  |  | Avg. depth (m) | 0.5 |

| Context No. | Type  | Fill Of | Width (m) | Depth (m) | Description   | Finds | Date |
|-------------|-------|---------|-----------|-----------|---|-------|------|
| 2100        | Layer |         | 2.1       | 0.35      | Ploughsoil. Mod grey brown silty sand with pebbles and grass rooting inclusions                 |       |      |
| 2101        | Layer |         | 2.1       | 0.17      | Subsoil. Mid orangey brown, gravel, firm  |       |      |
| 2102        | Layer |         |           |           | Natural. Mid reddish orange, small pebbled gravel, compact                                      |       |      |
| 2103        | Cut   |         | 2.23      | 0.4       | Pit. N-S alignment, with gradual sloping sides to the east and steep sloping sides to the west. |       |      |
| 2104        | Fill  | 2103    | 2.23      | 0.4       | Primary Fill. light greyish brown, clayey silt, moderately compact                              | Pot   | AS   |

| 2105   | Unexcavated feature |         | 0.9       |           | Ditch. NE/SW orientated, containing a dark greyish brown sandy silt fill.                 |       |      |
|--|---------------------|---------|-----------|-----------|---|-------|------|
| <b>Trench 22</b>   |                     |         |           |           |   |       |      |
| General description  |                     |         |           |           | Orientation   | NW-SE |      |
| Trench devoid of archaeology. Consists of Ploughsoil and subsoil overlaying natural                      |                     |         |           |           | Length (m)  | 30    |      |
|  |                     |         |           |           | Width (m)   | 2.1   |      |
|  |                     |         |           |           | Avg. depth (m)  | 0.5   |      |
| Context No.  | Type                | Fill Of | Width (m) | Depth (m) | Description   | Finds | Date |
| 2200   | Layer               |         | 2.1       | 0.33      | Ploughsoil. Mid grey brown, silty sand, friable with rooting and rounded stone inclusions |       |      |
| 2201   | Layer               |         | 2.1       | 0.13      | Subsoil. Mid orange grey silty clay with chalk inclusions                                 |       |      |
| 2202   | Layer               |         | 2.1       |           | Natural. Mid reddish orange, clay with occasional gravel patches, firm                    |       |      |
| 2203   | Void                |         |           |           |   |       |      |
| <b>Trench 23</b>   |                     |         |           |           |   |       |      |
| General description  |                     |         |           |           | Orientation   | NE-SW |      |
| Trench devoid of archaeology. Consists of Ploughsoil and subsoil overlaying natural                      |                     |         |           |           | Length (m)  | 30    |      |
|  |                     |         |           |           | Width (m)   | 2.1   |      |
|  |                     |         |           |           | Avg. depth (m)  | 0.5   |      |
| Context No.  | Type                | Fill Of | Width (m) | Depth (m) | Description   | Finds | Date |
| 2300   | Layer               |         | 2.1       | 0.33      | Ploughsoil. Mid grey brown silty sand, friable with rooting and grass root inclusions     |       |      |
| 2301   | Layer               |         | 2.1       | 0.2       | Subsoil. Mid greyish orange, silty sand, large quantities of gravel throughout            |       |      |
| 2302   | Layer               |         | 2.1       |           | Natural. Mid orangey red, silty sand with small pebbled gravel inclusions                 |       |      |
| <b>Trench 24</b>   |                     |         |           |           |   |       |      |
| General description  |                     |         |           |           | Orientation   | NW-SE |      |
| Trench devoid of archaeology. Consists of Ploughsoil and subsoil overlaying natural                      |                     |         |           |           | Length (m)  | 30    |      |
|  |                     |         |           |           | Width (m)   | 2.1   |      |
|  |                     |         |           |           | Avg. depth (m)  | 0.6   |      |
| Context No.  | Type                | Fill Of | Width (m) | Depth (m) | Description   | Finds | Date |
| 2400   | Layer               |         | 2.1       | 0.35      | Ploughsoil. Mid grey brown, silty sand, friable with rooting and pebble inclusions        |       |      |
| <b>Trench 25</b>   |                     |         |           |           |   |       |      |
| General description  |                     |         |           |           | Orientation   | NE-SW |      |
| Trench revealed one ditch. Consists of Ploughsoil overlaying natural geology of gravel and orangey sand. |                     |         |           |           | Length (m)  | 30    |      |
|  |                     |         |           |           | Width (m)   | 2.3   |      |
|  |                     |         |           |           | Avg. depth (m)  | 0.55  |      |

| Context No. | Type  | Fill Of | Width (m) | Depth (m) | Description   | Finds | Date |
|-------------|-------|---------|-----------|-----------|---|-------|------|
| 2500        | Layer |         |           | 0.5       | Ploughsoil. Dark grey brown, sandy silt.  |       |      |
| 2501        | Layer |         |           |           | Natural. Gravel and orangey silty sand.   |       |      |
| 2502        | Cut   | 2502    | 1         | 0.25      | Ditch. NW/SE orientated, with moderate sloping sides and flat base.   |       |      |
| 2503        | Fill  | 2502    |           | 0.2       | Primary Fill. Gravel within a greyish sand matrix.  |       |      |
| 2504        | Fill  | 2502    |           | 0.1       | Secondary Fill. Dark brown sandy silt.  |       |      |
| 2505        | Cut   |         | 1.8       | 0.07      | Tree Throw. Irregular in plan and profile, uneven base. Containing a single fill consisting of dark brown sandy silt. |       |      |

#### Trench 26

|  |                |       |
|--|----------------|-------|
| General description  | Orientation    | NE-SW |
| Trench contained 4 pits, 3 ditches and 4 post holes. Consists of ploughsoil and subsoil overlaying natural geology of silty sand | Length (m)     | 30    |
|  | Width (m)      | 2     |
|  | Avg. depth (m) | 0.6   |

| Context No. | Type                | Fill Of | Width (m) | Depth (m) | Description   | Finds    | Date |
|-------------|---------------------|---------|-----------|-----------|---|----------|------|
| 2600        | Layer               |         |           | 0.32      | Ploughsoil. Mid grey brown, silty clay, friable   |          |      |
| 2601        | Layer               |         |           | 0.2       | Subsoil. Dark brown grey, silty sand, loose   |          |      |
| 2602        | Layer               |         |           |           | Natural. Mid brown orange, silty sand, loose, frequent gravel   |          |      |
| 2603        | Cut                 |         | 1.24      | 0.3       | Pit. suspected pit, unknown true nature of feature because of over machining. profile witnessed in section sharp concave sides and base |          |      |
| 2604        | Fill                | 2603    | 1.24      | 0.3       | Primary Fill. mid blackish grey, silty sandy silt, compact  |          |      |
| 2605        | Cut                 |         | 1.14      | 0.46      | Pit. over machined, caught in section. suspected pit with steep sloping sides and a concave base  |          |      |
| 2606        | Fill                | 2605    | 1.14      | 0.46      | Primary Fill. compact, mid greyish black, sandy silt, with pot and bone amongst the inclusions.   | Br, Bone | LBA? |
| 2607        | Unexcavated feature |         | 1.48      |           | Pit. Unexcavated pit 6 metres from NE end of trench, fill mid purple brown, soft sandy silt Photo numbers (if needed) 155-156           |          |      |
| 2608        | Cut                 |         | 1.05      | 0.38      | Ditch. suspected ditch, not confirmed due to over machining. profile seen in section suggests steep sloping sides and a concave base.   |          |      |
| 2609        | Fill                | 2608    | 1.05      | 0.38      | Primary Fill. mid greyish black, very compact sandy silt with gravel throughout, no finds   |          |      |

|      |                     |      |      |      |   |  |  |
|------|---------------------|------|------|------|---|--|--|
| 2610 | Cut                 |      | 0.34 | 0.3  | Posthole. Excavated by machine, recorded in section                           |  |  |
| 2611 | Fill                | 2610 | 0.34 | 0.3  | Primary Fill. Silty gravel, mid black grey, compact                           |  |  |
| 2612 | Cut                 |      | 0.4  | 0.38 | Posthole. Machine excavated, recorded in section                              |  |  |
| 2613 | Fill                | 2612 | 0.4  | 0.38 | Primary Fill. Silt gravel, mid black grey, compact                            |  |  |
| 2614 | Unexcavated feature |      | 0.32 |      | Posthole. Sandy silty gravel, dark greyish black, loose                       |  |  |
| 2615 | Unexcavated feature |      | 0.66 |      | Pit. Silty clay, mid greyish brown, soft, frequent small rounded stones       |  |  |
| 2616 | Unexcavated feature |      | 0.6  | 0.33 | Ditch. Excavated by machine. Mid blackish grey, sandy, silty, gravel, compact |  |  |
| 2617 | Unexcavated feature |      | 0.6  | 0.3  | Ditch. Excavated by machine. Mid blackish grey, sandy, silty, gravel, compact |  |  |
| 2618 | Void                |      |      |      |   |  |  |
| 2619 | Void                |      |      |      |   |  |  |

#### Trench 27

|  |  |                |       |
|--|--|----------------|-------|
| General description  |  | Orientation    | NE-SW |
| Trench revealed a dense concentration of pits and posthole features, with a pair of ditches at the south-west end. Consists of ploughsoil overlaying a silty gravelly natural. |  | Length (m)     | 30    |
|  |  | Width (m)      | 2.1   |
|  |  | Avg. depth (m) | 0.45  |

| Context No. | Type  | Fill Of | Width (m) | Depth (m) | Description  | Findings      | Date      |
|-------------|-------|---------|-----------|-----------|--|---------------|-----------|
| 2700        | Layer |         | 2.1       | 0.4       | Ploughsoil. mid greyish brown, friable, with rooting and rounded stone inclusions                        |               |           |
| 2701        | Layer |         | 2.1       | 0.14      | Natural. Mid brownish orange sandy silt and gravel   |               |           |
| 2702        | Cut   |         | 0.56      | 0.32      | Ditch. Smaller of two ditches, cut by larger ditch   |               |           |
| 2703        | Fill  | 2702    | 0.56      | 0.32      | Secondary Fill. Mid greyish brown silty clay   | Br, Pot, Bone | Roman     |
| 2704        | Cut   |         | 1.16      | 0.42      | Ditch. larger and later of two ditches cuts smaller one runs NW-SE                                       |               |           |
| 2705        | Fill  | 2704    | 1.16      | 0.42      | Secondary Fill. dark greyish brown silty clay  | Br, Pot, Bone | Roman S.3 |
| 2706        | Cut   |         | 0.4       | 0.28      | Posthole. Circular, steep sides and flattish base  |               |           |
| 2707        | Fill  | 2706    | 0.4       | 0.28      | Primary Fill. Compact. Dark greyish black. Sandy silt. Frequent pea gravel and rounded stone inclusions. |               |           |
| 2708        | Cut   |         | 0.68      | 0.28      | Pit. Sub-circular, only partly within the trench. Sloping sides and a slightly concave base              |               |           |
| 2709        | Fill  | 2708    | 0.68      | 0.28      | Primary Fill. Soft. Dark greyish black. Sandy silt. Frequent gravel compacted at base.                   | Pot           | MBA/IA    |
| 2710        | Cut   |         | 0.37      | 0.2       | Posthole. concave sides and base, sill is truncated by a second pit [2712]                               |               |           |

|      |                     |      |      |      |   |      |        |
|------|---------------------|------|------|------|---|------|--------|
| 2711 | Fill                | 2710 | 0.37 | 0.2  | Primary Fill. Compact. Med brownish grey. Sandy silt. Moderate rounded stone inclusions.  |      |        |
| 2712 | Cut                 |      | 0.72 | 0.36 | Pit. circular with sharp concave sides and base   |      |        |
| 2713 | Fill                | 2712 | 0.72 | 0.36 | Primary Fill. Compact. Med brownish black. Sandy silt. Moderate rounded stones.   | Pot  | MBA/IA |
| 2714 | Cut                 |      | 0.38 | 0.36 | Posthole. sub circular in plan, very steep sides with a pointed base.   |      |        |
| 2715 | Fill                | 2714 | 0.38 | 0.36 | Primary Fill. Compact. Dark greyish black. Sandy silt. Compacted pea gravel and large subangular stones at base of feature. Sample number 4 | Bone | S.4    |
| 2716 | Unexcavated feature |      | 0.28 |      | Posthole. Med greyish brown fill. Compact fill with gravel inclusions.  |      |        |
| 2717 | Unexcavated feature |      | 0.4  |      | Pit. Dark blackish brown. Sandy silt. Soft. Frequent rounded stone inclusions.  |      |        |
| 2718 | Unexcavated feature |      | 0.76 |      | Pit. Med greyish brown. Sandy silt. Compact. Moderate rounded stone inclusions.   |      |        |
| 2719 | Unexcavated feature |      | 0.73 |      | Pit. Med yellowish brown. Sandy silt. Compact. Frequent sub angled stone inclusions.  |      |        |
| 2720 | Unexcavated feature |      | 0.82 |      | Pit. Dark blackish brown. Sandy silt. Soft. Chalky inclusions.  |      |        |
| 2721 | Unexcavated feature |      | 0.86 |      | Pit. Med greyish brown. Sandy silt. Soft. Chalky inclusions.  |      |        |
| 2722 | Unexcavated feature |      | 0.4  |      | Posthole. Med greyish brown. Gravelly sandy silt. Compact.  |      |        |
| 2723 | Unexcavated feature |      | 0.56 |      | Pit. Med greyish brown. Sandy silt. Frequent sub angled stone and chalky inclusions.  |      |        |
| 2724 | Unexcavated feature |      | 0.3  |      | Pit. Med greyish black. Soft. Sandy silt. Frequent sub angled stone inclusions.   |      |        |
| 2725 | Unexcavated feature |      | 0.7  |      | Pit. Med greyish brown. Sandy silty. Compact. Frequent stone inclusions.  |      |        |
| 2726 | Unexcavated feature |      | 0.47 |      | Posthole. Med greyish brown. Sandy silt. Compact. Frequent sub angled stone inclusions.   |      |        |
| 2727 | Unexcavated feature |      | 2.27 |      | Pit. Med greyish brown. Sandy silt. Compact. Frequent pea gravel and rounded stone inclusions.  |      |        |
| 2728 | Unexcavated feature |      | 0.33 |      | Pit. Dark brownish black. Sandy silt. Soft. Moderate rounded stone inclusions.  |      |        |
| 2729 | Unexcavated feature |      | 0.3  |      | Posthole. Med greyish black. Soft. Sandy silt. Frequent rounded stone inclusions.   |      |        |
| 2730 | Unexcavated feature |      | 0.3  |      | Pit. Med greyish brown. Sandy silt. Compact. Frequent fire cracked flint on surface.  |      |        |
| 2731 | Unexcavated feature |      | 0.41 |      | Pit. Med greyish brown. Sandy silt. Compact. Frequent gravel inclusions.  |      |        |



|      |                     |  |      |  |  |  |  |
|------|---------------------|--|------|--|--|--|--|
| 2732 | Unexcavated feature |  | 0.4  |  | Pit. Med greyish brown. Sandy silt. Compact. Frequent rounded stones.              |  |  |
| 2733 | Unexcavated feature |  | 0.3  |  | Posthole. Med greyish brown. Sandy silt. Soft. Frequent pea gravel inclusions.     |  |  |
| 2734 | Unexcavated feature |  | 0.34 |  | Pit. Med greyish black. Sandy silt. Soft. Moderate sub angled stone inclusions.    |  |  |
| 2735 | Unexcavated feature |  | 0.22 |  | Ditch. Med greyish black. Sandy gravelly silt. Compact.                            |  |  |
| 2736 | Unexcavated feature |  | 0.34 |  | Pit. Med brownish grey. Sandy silt. Soft. Occasional sub angled stones.            |  |  |
| 2737 | Unexcavated feature |  | 0.5  |  | Pit. Med brownish grey. Gravelly sandy silt. Compact.                              |  |  |
| 2738 | Unexcavated feature |  | 0.5  |  | Ditch. Dark greyish black. Sandy silt. Soft. Moderate sub angled stone inclusions. |  |  |
| 2739 | Unexcavated feature |  | 0.78 |  | Ditch. Dark greyish black. Sandy silt. Soft. Occasional sub angled stones.         |  |  |

#### Trench 28

|   |  |                |       |
|---|--|----------------|-------|
| General description   |  | Orientation    | NE-SW |
| Trench contains two ditches and sixty nine pits/postholes. Consists of ploughsoil and subsoil overlaying a silty gravelly natural |  | Length (m)     | 30    |
|   |  | Width (m)      | 10    |
|   |  | Avg. depth (m) | 0.45  |

| Context No. | Type  | Fill Of | Width (m) | Depth (m) | Description   | Findings          | Date    |
|-------------|-------|---------|-----------|-----------|---|-------------------|---------|
| 2800        | Layer |         |           | 0.24      | Ploughsoil. Dark grey brown, silty sand, firm                                 | Flint             |         |
| 2801        | Layer |         |           | 0.16      | Subsoil. Mid grey brown, silty sand, firm                                     |                   |         |
| 2802        | Layer |         |           |           | Natural. Mid brown yellow, silty sand, loose with frequent gravel inclusions. |                   |         |
| 2803        | Cut   |         | 0.57      | 0.48      | Posthole. steep sides and concave base  |                   |         |
| 2804        | Fill  | 2803    | 0.37      | 0.48      | Post-pipe. Dark brown grey, silty sand, friable                               | FC, Bone          | LBA S.7 |
| 2805        | Cut   |         | 1.22      | 0.32      | Ditch   |                   |         |
| 2806        | Fill  | 2805    | 1.22      | 0.32      | Secondary Fill. Dark grey brown, silty sand, loose                            |                   |         |
| 2807        | Cut   |         | 1.46      | 0.59      | Pit. slightly oval in shape with steep sides and a slightly convex base       |                   |         |
| 2808        | Fill  | 2807    | 1.46      | 0.59      | Secondary Fill. dark brown grey, silty sand, loose                            | Pot, FC, Br, Bone | AS S.8  |
| 2809        | Void  |         |           |           |   |                   |         |
| 2810        | Cut   |         | 0.35      | 0.24      | Posthole  |                   |         |
| 2811        | Fill  | 2810    | 0.35      | 0.24      | Post-pipe. Dark grey brown, silty sand, friable                               |                   |         |
| 2812        | Cut   |         | 0.33      | 0.27      | Posthole  |                   |         |
| 2813        | Fill  | 2812    | 0.33      | 0.27      | Post-pipe. Dark grey brown, silty sand, friable                               |                   |         |
| 2814        | Fill  | 2803    | 0.17      | 0.26      | Deliberate Backfill. Mid grey brown, silty sand, friable                      |                   |         |

|      |                     |  |      |  |  |      |         |
|------|---------------------|--|------|--|--|------|---------|
| 2815 | Unexcavated feature |  | 2    |  | Pit. Oval in plan. Mid brown grey, silty sand, friable           |      |         |
| 2816 | Unexcavated feature |  | 0.37 |  | Posthole. Circular in plan. Mid grey brown, silty sand, friable  |      |         |
| 2817 | Unexcavated feature |  | 0.38 |  | Posthole. Circular in plan. Mid grey brown, silty sand, friable  |      |         |
| 2818 | Unexcavated feature |  | 0.36 |  | Posthole. Circular in plan. Mid grey brown silty sand, friable   |      |         |
| 2819 | Unexcavated feature |  | 0.74 |  | Pit. Circular in plan. Dark grey brown, silty sand, friable      |      |         |
| 2820 | Unexcavated feature |  | 0.37 |  | Posthole. Circular in plan. Dark grey brown, silty sand, friable | Bone |         |
| 2821 | Unexcavated feature |  | 0.27 |  | Posthole. Circular in plan. Dark grey brown, silty sand, friable |      |         |
| 2822 | Unexcavated feature |  | 0.38 |  | Posthole. Circular in plan. Dark grey brown, silty sand, friable |      |         |
| 2823 | Unexcavated feature |  | 1.3  |  | Pit. Oval in plan. Dark brown grey, silty sand, friable          | Pot  | LBA/EIA |
| 2824 | Unexcavated feature |  | 0.44 |  | Posthole. Circular in plan. Mid brown grey, silty sand, friable  |      |         |
| 2825 | Unexcavated feature |  | 0.19 |  | Posthole. Circular in plan. Mid brown grey, silty sand, friable  |      |         |
| 2826 | Unexcavated feature |  | 0.47 |  | Posthole. Circular in plan. Dark grey brown, silty sand, friable |      |         |
| 2827 | Unexcavated feature |  | 0.7  |  | Pit. Circular in plan. Mid brown grey, silty sand, friable       |      |         |
| 2828 | Unexcavated feature |  | 0.31 |  | Posthole. Circular in plan. Mid grey brown, silty sand, friable  |      |         |
| 2829 | Unexcavated feature |  | 0.24 |  | Posthole. Circular in plan. Mid brown grey, silty sand, friable  |      |         |
| 2830 | Unexcavated feature |  | 0.27 |  | Posthole. Circular in plan. Mid grey brown, silty sand, friable  |      |         |
| 2831 | Unexcavated feature |  | 0.35 |  | Posthole. Circular in plan. Dark grey brown, silty sand, friable |      |         |
| 2832 | Unexcavated feature |  | 0.62 |  | Pit. Oval in plan. Dark grey brown, silty sand, friable          |      |         |
| 2833 | Unexcavated feature |  | 0.38 |  | Posthole. Circular in plan. Mid grey brown, silty sand, friable  |      |         |
| 2834 | Unexcavated feature |  | 0.29 |  | Posthole. Circular in plan. Mid brown grey, silty sand, friable  |      |         |
| 2835 | Unexcavated feature |  | 0.4  |  | Pit. Dark brown grey, silty sand, friable                        |      |         |
| 2836 | Unexcavated feature |  | 0.39 |  | Pit. Circular in plan. Mid grey brown, silty sand, friable       |      |         |
| 2837 | Unexcavated feature |  | 0.24 |  | Posthole. Circular in plan. Mid grey brown, silty sand, friable  |      |         |
| 2838 | Unexcavated feature |  | 0.41 |  | Pit. Circular in plan. Mid grey brown, silty sand, friable       |      |         |
| 2839 | Unexcavated feature |  | 3.5  |  | Pit. Irregular in plan. Dark brown grey, silty sand, friable     |      |         |
| 2840 | Unexcavated feature |  | 0.94 |  | Pit. Circular in plan. Dark grey brown, silty sand, friable      |      |         |
| 2841 | Unexcavated feature |  | 0.28 |  | Posthole. Circular in plan. Mid grey brown, silty sand, friable  |      |         |
| 2842 | Unexcavated feature |  | 0.31 |  | Posthole. Circular in plan. Dark grey brown, silty sand, friable |      |         |
| 2843 | Unexcavated feature |  | 2.8  |  | Pit. Irregular in plan. Dark grey brown, silty sand, friable     |      |         |

|      |                     |  |      |  |   |               |        |
|------|---------------------|--|------|--|---|---------------|--------|
| 2844 | Unexcavated feature |  | 0.42 |  | Posthole. Circular in plan. Dark grey brown, silty sand, friable  |               |        |
| 2845 | Unexcavated feature |  | 0.56 |  | Pit. Circular in plan. Dark grey brown, silty sand, friable       |               |        |
| 2846 | Unexcavated feature |  | 1.84 |  | Pit. Circular in plan. Dark grey brown, silty sand, friable       |               |        |
| 2847 | Unexcavated feature |  | 0.22 |  | Posthole. Circular in plan. Dark grey brown, silty sand, friable  |               |        |
| 2848 | Unexcavated feature |  | 0.35 |  | Posthole. Circular in plan. Dark grey brown, silty sand, friable  |               |        |
| 2849 | Unexcavated feature |  | 0.3  |  | Posthole. Circular in plan. Dark grey brown, silty sand, friable  |               |        |
| 2850 | Unexcavated feature |  | 1.34 |  | Pit. Oval in plan. Dark grey brown, silty sand, friable           |               |        |
| 2851 | Unexcavated feature |  | 0.27 |  | Posthole. Circular in plan. Dark grey brown, silty sand, friable. |               |        |
| 2852 | Unexcavated feature |  | 0.39 |  | Posthole. Circular in plan. Dark grey brown, silty sand, friable  |               |        |
| 2853 | Unexcavated feature |  | 1.53 |  | Pit. Circular in plan. Mid grey brown, silty sand, friable        |               |        |
| 2854 | Unexcavated feature |  | 2.5  |  | Pit. Circular in plan. Dark grey brown, silty sand, friable       | Pot           | AS     |
| 2855 | Unexcavated feature |  | 2    |  | Pit. Oval in plan. Dark grey brown, silty sand, friable           |               |        |
| 2856 | Unexcavated feature |  | 0.63 |  | Pit. Circular in plan. Dark grey brown, silty sand, friable       | FC            |        |
| 2857 | Unexcavated feature |  | 2.9  |  | Pit. Oval in plan. Dark brown grey, silty sand, friable           | Pot, Bone     | Roman  |
| 2858 | Unexcavated feature |  | 0.93 |  | Pit. Oval in plan. Dark grey brown, silty sand, friable           | FC, Pot, Bone | Roman  |
| 2859 | Unexcavated feature |  | 0.93 |  | Pit. Circular in plan. Dark brown grey, silty sand, friable       |               |        |
| 2860 | Unexcavated feature |  | 0.56 |  | Ditch. Linear NW/SE. Dark grey brown, silty sand, friable         | Pot, Bone     | LIA/ER |
| 2861 | Unexcavated feature |  | 0.58 |  | Pit. Circular in plan. Dark grey brown, silty sand, friable       |               |        |
| 2862 | Unexcavated feature |  | 0.34 |  | Posthole. Circular in plan. Dark grey brown, silty sand, friable  |               |        |
| 2863 | Unexcavated feature |  | 0.35 |  | Posthole. Circular in plan. Dark grey brown, silty sand, friable  |               |        |
| 2864 | Unexcavated feature |  | 0.55 |  | Pit. Circular in plan. Dark grey brown, silty sand, friable       |               |        |
| 2865 | Unexcavated feature |  | 3.1  |  | Pit. Circular in plan. Dark grey brown, silty sand, friable       | Pot           | Roman  |
| 2866 | Unexcavated feature |  | 0.35 |  | Posthole. Circular in plan. Dark grey brown, silty sand, friable  |               |        |
| 2867 | Unexcavated feature |  | 0.33 |  | Posthole. Circular in plan. Dark grey brown, silty sand, friable  |               |        |
| 2868 | Unexcavated feature |  | 0.32 |  | Posthole. Circular in plan. Dark grey brown, silty sand, friable  |               |        |
| 2869 | Unexcavated feature |  | 0.32 |  | Posthole. Circular in plan. Dark grey brown, silty sand, friable  |               |        |
| 2870 | Unexcavated feature |  | 2    |  | Pit. Oval in plan. Dark grey brown, silty sand, friable           |               |        |
| 2871 | Unexcavated feature |  | 0.3  |  | Posthole. Circular in plan. Dark grey brown, silty sand, friable  |               |        |
| 2872 | Unexcavated feature |  | 0.37 |  | Posthole. Circular in plan. Dark grey brown, silty sand, friable  |               |        |

|      |                     |  |      |  |  |                   |        |
|------|---------------------|--|------|--|--|-------------------|--------|
| 2873 | Unexcavated feature |  | 0.74 |  | Pit. Circular in plan. Dark grey brown, silty sand, friable      |                   |        |
| 2874 | Unexcavated feature |  | 3.6  |  | Pit. Circular in plan. Dark grey brown, silty sand, friable      | FC, Pot, flint    | ER     |
| 2875 | Unexcavated feature |  | 0.54 |  | Pit. Dark grey brown, silty sand, friable                        |                   |        |
| 2876 | Unexcavated feature |  | 0.35 |  | Posthole. Circular in plan. Dark grey brown, silty sand, friable |                   |        |
| 2877 | Unexcavated feature |  | 0.56 |  | Pit. Circular in plan. Dark grey brown, silty sand, friable      |                   |        |
| 2878 | Unexcavated feature |  | 0.4  |  | Pit. Circular in plan. Dark grey brown, silty sand, friable      |                   |        |
| 2879 | Unexcavated feature |  | 0.36 |  | Posthole. Circular in plan. Dark grey brown, silty sand, friable |                   |        |
| 2880 | Unexcavated feature |  | 2    |  | Pit. Circular in plan. Dark grey brown, silty sand, friable      | FC, Br, Pot, Bone | LIA/ER |

#### Trench 29

|  |  |  |  |                |      |
|--|--|--|--|----------------|------|
| General description  |  |  |  | Orientation    | N-S  |
| 3 ditches and 2 pits revealed. Consists of ploughsoil and subsoil overlaying natural geology of silty sand with gravel |  |  |  | Length (m)     | 30   |
|  |  |  |  | Width (m)      | 2    |
|  |  |  |  | Avg. depth (m) | 0.55 |

| Context No. | Type                | Fill Of | Width (m) | Depth (m) | Description   | Findings          | Date    |
|-------------|---------------------|---------|-----------|-----------|---|-------------------|---------|
| 2900        | Layer               |         |           | 0.27      | Ploughsoil. Mid grey brown, silty clay, friable   |                   |         |
| 2901        | Layer               |         |           | 0.25      | Subsoil. Dark grey brown, silty sand, loose   |                   |         |
| 2902        | Layer               |         |           |           | Natural. Mid brown orange, silty sand, loose, frequent gravel inclusions  |                   |         |
| 2903        | Cut                 |         | 1.2       | 0.35      | Ditch. NE/SW running, concave with deep sides   |                   |         |
| 2904        | Fill                | 2903    | 1.2       | 0.25      | Primary Fill. mid grey brown, sandy silt moderately firm  | Br, FC, Pot, Bone | IA      |
| 2905        | Cut                 |         | 1.15      | 0.7       | Ditch. NE/SW running with V shaped profile  |                   |         |
| 2906        | Fill                | 2905    | 1.15      | 0.7       | Primary Fill. mid greyish brown sandy silt, firm compaction   | Br, FC, Pot       | MBA/IA  |
| 2907        | Cut                 |         | 1.15      | 0.47      | Ditch. NE/SW running, possible boundary concave profile   |                   |         |
| 2908        | Fill                | 2907    | 1.15      | 0.47      | Primary Fill. dark greyish brown, sandy silt, firm  | Br, Pot, Bone     | LBA/EIA |
| 2909        | Unexcavated feature |         | 1.1       |           | Ditch. Feature located in the middle of tr. 29 runs N/E-S/W through trench. Fill consists of a dark greyish brown, sandy silt with frequent gravel. |                   |         |
| 2910        | Cut                 |         | 0.43      | 0.39      | Posthole. circular in plan, steep sloping sides and a concave base  |                   |         |
| 2911        | Fill                | 2910    | 0.43      | 0.39      | Primary Fill. Dark greyish brown, silty sand, friable   |                   |         |
| 2912        | Unexcavated feature |         | 3.8       |           | Pit. Feature located at N/W end of trench. Fill consist of a dark greyish brown, sandy silt with frequent gravel. Possible S.F.B?                   |                   |         |

| 2913  | Fill                | 2903    | 0.7       | 0.25      | Primary Fill. light greyish brown, sandy silt, soft                      |       |         |
|---|---------------------|---------|-----------|-----------|--|-------|---------|
| <b>Trench 30</b>  |                     |         |           |           |  |       |         |
| General description   |                     |         |           |           | Orientation  | NE-SW |         |
| Trench devoid of archaeology. Consists of ploughsoil and subsoil overlaying natural geology of silty sand with gravel |                     |         |           |           | Length (m)   | 30    |         |
|   |                     |         |           |           | Width (m)  | 2     |         |
|   |                     |         |           |           | Avg. depth (m)   | 0.45  |         |
| Context No.   | Type                | Fill Of | Width (m) | Depth (m) | Description  | Finds | Date    |
| 3000  | Layer               |         |           | 0.26      | Ploughsoil. Mid grey brown, silty clay, friable                          |       |         |
| 3001  | Layer               |         |           | 0.09      | Subsoil. Dark grey brown, silty sand, loose                              |       |         |
| 3002  | Layer               |         |           |           | Natural. Mid brown orange, silty sand, loose, frequent gravel inclusions |       |         |
| <b>Trench 31</b>  |                     |         |           |           |  |       |         |
| General description   |                     |         |           |           | Orientation  | NW-SE |         |
| Consists of ploughsoil and subsoil overlaying colluvium and natural geology of silty sand with gravel                 |                     |         |           |           | Length (m)   | 30    |         |
|   |                     |         |           |           | Width (m)  | 2     |         |
|   |                     |         |           |           | Avg. depth (m)   | 1     |         |
| Context No.   | Type                | Fill Of | Width (m) | Depth (m) | Description  | Finds | Date    |
| 3100  | Layer               |         |           | 0.27      | Ploughsoil. Mid grey brown, silty clay, friable                          |       |         |
| 3101  | Layer               |         |           | 0.33      | Subsoil. Dark grey brown, silty sand, loose                              |       |         |
| 3102  | Layer               |         |           |           | Natural. Mid brown orange, silty sand, loose, frequent gravel inclusions |       |         |
| 3103  | Layer               |         |           | 0.43      | Colluvial Layer. Light yellow brown, silty sand, loose                   | Pot   | LBA/EIA |
| 3104  | Unexcavated feature |         | 1.83      |           | Pit. Unexcavated. Dark brown gravelly sandy silt                         |       |         |
| 3105  | Unexcavated feature |         | 0.46      |           | Pit. Unexcavated. Dark brown gravelly sandy silt                         |       |         |
| 3106  | Cut                 |         | 0.38      | 0.35      | Pit. Section in bulk. Unexcavated  |       |         |
| 3107  | Fill                | 3106    | 0.38      | 0.35      | Primary Fill. Dark brown gravelly sandy silt                             |       |         |
| 3108  | Cut                 |         | 0.62      | 0.36      | Pit. Section in bulk   |       |         |
| 3109  | Fill                | 3108    | 0.62      | 0.36      | Primary Fill. Dark brown gravelly sandy silt                             |       |         |
| 3110  | Cut                 |         | 0.47      | 0.41      | Pit. seen only in bulk section concave sides and base                    |       |         |
| 3111  | Fill                | 3110    | 0.47      | 0.41      | Primary Fill. Dark brown gravelly sandy silt                             |       |         |
| 3112  | Unexcavated feature |         | 0.28      |           | Pit. Unexcavated. Dark brown gravelly silty sand                         |       |         |
| 3113  | Cut                 |         | 0.83      | 0.37      | Pit. Section in bulk due to over machined trench. concave profile        |       |         |
| 3114  | Fill                | 3113    | 0.83      | 0.38      | Primary Fill. Mid brown sandy silt                                       |       |         |
| 3115  | Cut                 |         | 2.92      | 0.49      | Pit. Possible SFB  |       |         |

|      |      |      |      |      |   |                          |                  |
|------|------|------|------|------|---|--------------------------|------------------|
| 3116 | Fill | 3115 | 2.92 | 0.49 | Primary Fill. Dark greyish brown sandy silt                               | Pot, Bone, Quern, Flint, | Anglo-Saxon, S.5 |
| 3117 | Cut  |      | 0.47 | 0.48 | Posthole. Not bottomed, excavated to 1m, seen in section and in plan      |                          |                  |
| 3118 | Fill | 3117 | 0.47 | 0.48 | Primary Fill. Dark greyish brown sandy silt                               |                          |                  |
| 3119 | Cut  |      | 0.33 | 0.04 | Pit. over machined pit. limited remains, concave profile of what was left |                          |                  |
| 3120 | Fill | 3119 | 0.33 | 0.04 | Primary Fill. Mid greyish brown sandy silt                                | Pot                      | MBA/IA           |
| 3121 | Cut  |      | 0.35 | 0.1  | Pit. Pit in bottom of SFB 3115.   |                          |                  |
| 3122 | Fill | 3121 | 0.35 | 0.1  | Primary Fill. Dark grey brown sandy silt                                  | Bone                     |                  |

### Trench 32

|   |  |  |  |  |                |       |
|---|--|--|--|--|----------------|-------|
| General description   |  |  |  |  | Orientation    | NE-SW |
| Trench devoid of archaeology. Consists of ploughsoil overlaying natural geology of silty clay |  |  |  |  | Length (m)     | 30    |
|   |  |  |  |  | Width (m)      | 2     |
|   |  |  |  |  | Avg. depth (m) | 0.42  |

| Context No. | Type  | Fill Of | Width (m) | Depth (m) | Description   | Finds | Date |
|-------------|-------|---------|-----------|-----------|---|-------|------|
| 3200        | Layer |         | 2.1       | 0.32      | Ploughsoil. Mid grey brown, silty sand, friable with rooting and rounded stone inclusions |       |      |
| 3201        | Layer |         | 2.2       |           | Natural. Mid reddish orange gravel, firm  |       |      |

### Trench 33

|   |  |  |  |  |                |       |
|---|--|--|--|--|----------------|-------|
| General description   |  |  |  |  | Orientation    | NW-SE |
| Trench devoid of archaeology. Consists of ploughsoil and subsoil overlaying natural geology of silty sand with gravel |  |  |  |  | Length (m)     | 30    |
|   |  |  |  |  | Width (m)      | 2     |
|   |  |  |  |  | Avg. depth (m) | 0.47  |

| Context No. | Type  | Fill Of | Width (m) | Depth (m) | Description  | Finds | Date |
|-------------|-------|---------|-----------|-----------|--|-------|------|
| 3300        | Layer |         |           | 0.28      | Ploughsoil. Mid grey brown, silty clay, friable                          |       |      |
| 3301        | Layer |         |           | 0.19      | Subsoil. Dark grey brown, silty sand, loose                              |       |      |
| 3302        | Layer |         |           |           | Natural. Mid brown orange, silty sand, loose, frequent gravel inclusions |       |      |

### Trench 34

|  |  |  |  |  |                |      |
|--|--|--|--|--|----------------|------|
| General description  |  |  |  |  | Orientation    | N-S  |
| Trench contains one ditch. Consists of ploughsoil and subsoil overlaying natural geology of silty clay |  |  |  |  | Length (m)     | 30   |
|  |  |  |  |  | Width (m)      | 2    |
|  |  |  |  |  | Avg. depth (m) | 0.51 |

| Context No. | Type  | Fill Of | Width (m) | Depth (m) | Description                                     | Finds | Date |
|-------------|-------|---------|-----------|-----------|---|-------|------|
| 3400        | Layer |         |           | 0.26      | Ploughsoil. Mid grey brown, silty clay, friable |       |      |

|      |       |      |   |      |  |  |  |
|------|-------|------|---|------|--|--|--|
| 3401 | Layer |      |   | 0.15 | Natural. Mid brown orange, silty clay, firm                  |  |  |
| 3402 | Cut   |      | 1 | 0.15 | Ditch. NW/SE running, concave sides                          |  |  |
| 3403 | Fill  | 3402 | 1 | 0.15 | Primary Fill. Mid grey brown, silty sand, moderately compact |  |  |

#### Trench 35

|  |  |  |  |                |       |
|--|--|--|--|----------------|-------|
| General description  |  |  |  | Orientation    | NE-SW |
| Trench contains three ditches Consists of Ploughsoil overlaying gravelly natural |  |  |  | Length (m)     | 30    |
|  |  |  |  | Width (m)      | 2.1   |
|  |  |  |  | Avg. depth (m) | 0.3   |

| Context No. | Type  | Fill Of | Width (m) | Depth (m) | Description   | Finds | Date |
|-------------|-------|---------|-----------|-----------|---|-------|------|
| 3500        | Layer |         |           | 0.25      | Ploughsoil. Mid grey brown, sandy clay, friable               |       |      |
| 3501        | Layer |         |           | 0.16      | Natural. Mid brown yellow, silty clay, firm                   |       |      |
| 3502        | Cut   |         | 1.1       | 0.27      | Ditch. concave profile, running NW/SE                         |       |      |
| 3503        | Fill  | 3502    | 1.1       | 0.27      | Primary Fill. dark grey brown, sandy silt, firm               |       |      |
| 3504        | Cut   |         | 0.7       | 0.1       | Ditch. NW/SE running drainage ditch                           |       |      |
| 3505        | Fill  | 3504    | 0.7       | 0.1       | Primary Fill. mid grey brown, natural infilling, sandy silt   |       |      |
| 3506        | Cut   |         | 0.8       | 0.12      | Ditch   |       |      |
| 3507        | Fill  | 3506    | 0.8       | 0.12      | Primary Fill. Dark grey brown, silty clay, moderately compact |       |      |

#### Trench 36

|   |  |  |  |                |     |
|---|--|--|--|----------------|-----|
| General description   |  |  |  | Orientation    | E-W |
| Trench devoid of archaeology. Consists of ploughsoil overlaying natural |  |  |  | Length (m)     | 30  |
|   |  |  |  | Width (m)      | 2.1 |
|   |  |  |  | Avg. depth (m) | 0.3 |

| Context No. | Type  | Fill Of | Width (m) | Depth (m) | Description   | Finds | Date |
|-------------|-------|---------|-----------|-----------|---|-------|------|
| 3600        | Layer |         | 2.1       | 0.28      | Ploughsoil. Mid grey brown, silty sand, friable with grass rooting and rounded stone inclusions |       |      |
| 3601        | Layer |         | 2.1       |           | Natural. Mid whiteish yellow, silty sand, loose, with gravel patches.                           |       |      |

#### Trench 37

|   |  |  |  |                |       |
|---|--|--|--|----------------|-------|
| General description   |  |  |  | Orientation    | NE-SW |
| Trench contained, 1 ditch. Consists of Ploughsoil overlaying colluvium and silty gravelly natural |  |  |  | Length (m)     | 30    |
|   |  |  |  | Width (m)      | 2.1   |
|   |  |  |  | Avg. depth (m) | 0.3   |

| Context No. | Type  | Fill Of | Width (m) | Depth (m) | Description                                     | Finds | Date |
|-------------|-------|---------|-----------|-----------|---|-------|------|
| 3700        | Layer |         |           |           | Ploughsoil. Mid grey brown, silty clay, friable |       |      |

|      |       |      |      |     |  |  |  |
|------|-------|------|------|-----|--|--|--|
| 3701 | Layer |      |      |     | Natural. Mid reddish orange silty sand with gravel throughout      |  |  |
| 3702 | Cut   |      | 2.03 | 0.5 | Ditch. Concave base, irregular sides (concave on w. straight on e) |  |  |
| 3703 | Fill  | 3702 | 2.03 | 0.5 | Primary Fill. Very dark grey brown, clay silt                      |  |  |
| 3704 | Layer |      |      |     | Colluvial Layer. Light brown grey silt                             |  |  |

#### Trench 38

|   |  |                |       |
|---|--|----------------|-------|
| General description   |  | Orientation    | NW-SE |
| Trench contains three pits, a natural feature and a ditch. Consists of Ploughsoil overlaying gravelly natural |  | Length (m)     | 24    |
|   |  | Width (m)      | 2.1   |
|   |  | Avg. depth (m) | 0.3   |

| Context No. | Type                | Fill Of | Width (m) | Depth (m) | Description   | Finds | Date |
|-------------|---------------------|---------|-----------|-----------|---|-------|------|
| 3800        | Layer               |         |           |           | Ploughsoil. Dark brown clay silt  |       |      |
| 3801        | Layer               |         |           |           | Natural. Mid red brown sandy silt   |       |      |
| 3802        | Cut                 |         | 1.04      | 0.43      | Pit. Steep slope, concave base  |       |      |
| 3803        | Fill                | 3802    | 1.04      | 0.43      | Primary Fill. Very dark brown clay silt   |       |      |
| 3804        | Cut                 |         | 0.43      | 0.15      | Pit. Flat base concave sides  |       |      |
| 3805        | Fill                | 3804    | 0.43      | 0.15      | Primary Fill. Very dark brown clay silt   |       |      |
| 3806        | Cut                 |         | 0.58      | 0.25      | Pit. Concave base steep sides   |       |      |
| 3807        | Fill                | 3806    | 0.58      | 0.25      | Primary Fill. Very dark brown clay silt   |       |      |
| 3808        | Unexcavated feature |         | 2         |           | Tree Throw. Large dark area in possible tree throw contains a charcoal. Possible in situ burning?                 |       |      |
| 3809        | Unexcavated feature |         | 1.47      |           | Ditch. Continuation of ditch [2907]   |       |      |
| 3810        | Unexcavated feature |         | 3         |           | Other Cut. Dark patch near tree throw, unsure whether new feature, or part of something else due to bulk presence |       |      |

#### Trench 39

|   |  |                |       |
|---|--|----------------|-------|
| General description   |  | Orientation    | NW-SE |
| Trench devoid of archaeology. Consists of ploughsoil and colluvium to natural geology of gravel. Natural geology only exposed in the north-western end of the trench. |  | Length (m)     | 30    |
|   |  | Width (m)      | 2.4   |
|   |  | Avg. depth (m) | 1     |

| Context No. | Type  | Fill Of | Width (m) | Depth (m) | Description   | Finds | Date |
|-------------|-------|---------|-----------|-----------|---|-------|------|
| 3900        | Layer |         |           | 0.29      | Ploughsoil. Mid grey brown, silty clay, friable                               |       |      |
| 3901        | Layer |         |           | 0.16      | Subsoil. Mid brown orange, silty clay, firm                                   |       |      |
| 3902        | Layer |         |           | 0.49      | Colluvial Layer. Mid grey brown, silty sand with gravel inclusions throughout |       |      |

#### Trench 40



| General description  |                     |         |           |           |  | Orientation    | NE-SW    |
|--|---------------------|---------|-----------|-----------|--|----------------|----------|
| Trench devoid of archaeology. Consists of ploughsoil and colluvium overlying natural geology of gravel. Natural geology only encountered in the north-eastern end of the trench. |                     |         |           |           |  | Length (m)     | 30       |
|  |                     |         |           |           |  | Width (m)      | 2.3      |
|  |                     |         |           |           |  | Avg. depth (m) | 1        |
| Context No.  | Type                | Fill Of | Width (m) | Depth (m) | Description  | Finds          | Date     |
| 4000   | Layer               |         | 2.1       | 0.35      | Ploughsoil. Mid grey brown, silty clay, friable  |                |          |
| 4001   | Layer               |         |           | 0.62      | Colluvial Layer. Dark orangey brown, silty sand, friable with gravel inclusions                |                |          |
| 4002   | Layer               |         |           |           | Natural. Mid orange brown, sandy gravel.   |                |          |
| <b>Trench 41</b>   |                     |         |           |           |  |                |          |
| General description  |                     |         |           |           |  | Orientation    | NW-SE    |
| Trench devoid of archaeology. Consists of ploughsoil and colluvium. Natural geology not reached across the trench.   |                     |         |           |           |  | Length (m)     | 30       |
|  |                     |         |           |           |  | Width (m)      | 2.3      |
|  |                     |         |           |           |  | Avg. depth (m) | 1        |
| Context No.  | Type                | Fill Of | Width (m) | Depth (m) | Description  | Finds          | Date     |
| 4100   | Layer               |         |           | 0.22      | Ploughsoil. Mid grey brown, silty clay, friable  |                |          |
| 4101   | Layer               |         |           | 0.42      | Colluvial Layer. Mid orangey brown, silty sand, gravel throughout, firm                        |                |          |
| 4102   | Layer               |         |           | 0.44      | Colluvial Layer. Mid grey brown, frequent small-medium subangular and subrounded stones        |                |          |
| <b>Trench 42</b>   |                     |         |           |           |  |                |          |
| General description  |                     |         |           |           |  | Orientation    | NE-SW    |
| Trench contained two ditches. Consists of ploughsoil and colluvium.  |                     |         |           |           |  | Length (m)     | 30       |
|  |                     |         |           |           |  | Width (m)      | 2.3      |
|  |                     |         |           |           |  | Avg. depth (m) | 0.54     |
| Context No.  | Type                | Fill Of | Width (m) | Depth (m) | Description  | Finds          | Date     |
| 4200   | Layer               |         |           | 0.39      | Ploughsoil. Mid grey brown, silty clay, friable  |                |          |
| 4201   | Layer               |         |           |           | Colluvial Layer. Mid brown orange, silty clay, firm  |                |          |
| 4202   | Cut                 |         | 1.5       | 0.45      | Ditch  |                |          |
| 4203   | Fill                | 4202    | 1.5       | 0.45      | Primary Fill. Dark brown grey, silty loam, frequent stone and flint incl, finds of pot and cbm | Pot            | IA, PMed |
| 4204   | Unexcavated feature |         | 1.5       | 0.45      | Ditch. Dark grey brown silty clay.   |                |          |

### B.1 Prehistoric Pottery

By Alex Davies

#### Introduction

- B.1.1 The evaluation uncovered 142 sherds (1414g) of hand-collected prehistoric pottery from 30 contexts across 11 trenches. One context dated to the middle Neolithic, and the remaining contexts probably date to the late Bronze Age or early Iron Age, although spot-date ranges often include a wider span of dates. The material is reasonably well preserved with a quite high mean sherd weight of 10g.

#### Methodology

- B.1.2 Pottery from each context was scanned with spot-dates given based on the latest material present. Fabrics were recorded in order of their approximate frequency in any one context. The two most common inclusion types were noted, using the following fabric codes:
- Fl Flint
  - lo Iron Oxides
  - Qg Glauconitic sand (can include quartz sand)
  - Qs Quartz sand
- B.1.3 The grade of the fabric was also recorded with a number suffix, ranging from 1 (fine) to 4 (very coarse).
- B.1.4 The pottery recovered from sieved environmental samples was scanned. All these contexts produced larger hand-recovered pottery assemblages, and the material from the sieved provided no additional dating information. The sieved material is not quantified in this report.

#### Middle Neolithic

- B.1.5 Context 1710 dated to the middle Neolithic period. Sherds from two vessels were recovered, including a rim from a probable Mortlake (Peterborough Ware) bowl with bird bone impressions on the inner, outer and top part of the rim. This was in a coarse, poorly-sorted flint fabric. The other vessel was a single highly abraded sherd in a sand and iron oxide fabric with fingertip decoration.
- B.1.6 Peterborough Ware is a pottery tradition starting in the mid-fourth millennium and continuing into the early third millennium cal BC.

#### Later Bronze Age and early Iron Age

- B.1.7 Fabrics were flint-tempered, occasionally with the addition of glauconitic sand. A few vessels had quartz sand in the fabric. Most of the contexts, which did not produce sherds with diagnostic form traits, have been given a broad spot-date – middle Bronze Age to Iron Age – due to the continuity in fabrics during this period in the region (Brudenell 2016, 380). All of the material with diagnostic forms within this later prehistoric group dated to either the late Bronze Age or early Iron Age, and there

were no diagnostic middle Bronze Age or middle Iron Age sherds. This makes it likely that all of the material spot-dated to the middle Bronze Age to Iron Age is in fact late Bronze Age or early Iron Age.

- B.1.8 The probable late Bronze Age vessels included shouldered jars with out-turned necks in contexts 1703, 1748 and 2908. The vessel in context 2908 also had a pedestal base. Shouldered jars with out-turned necks probably date to the late Bronze Age, although might be early Iron Age. Context 2804 produced the base of a vessel with perforations. This was in an inclusion-free fabric and cannot be closely dated on its own but was associated with a late Bronze Age perforated plate (see fired clay report, below).
- B.1.9 The diagnostic early Iron Age material includes red-coated vessels in contexts 1210 and 2703. The vessel in 2703 was otherwise undiagnostic and in a flint fabric, but the vessel in context 1210 was from a small angular bowl in a fine sand fabric.
- B.1.10 The assemblage probably dates to the latter part of the late Bronze Age, c 1000-800 cal BC, continuing into the early Iron Age, c 800-350 cal BC.

#### Retention

- B.1.11 The pottery has future research value and should all be retained.

| Context | No. of sherds | Weight (g) | Fabric                    | Spot-date | Comment  |
|---------|---------------|------------|---------------------------|-----------|--|
| 110     | 1             | 1          | FI2                       | MBA-IA    | Residual   |
| 208     | 2             | 2          | FI2                       | MBA-IA    |  |
| 807     | 2             | 5          | FI2                       | MBA-IA    |  |
| 1203    | 21            | 351        | FI3; FI2                  | LBA/EIA   | Shouldered jar with upright/slightly outturned neck. Burnishing  |
| 1208    | 2             | 3          | ?                         | Prehis    | Tiny, very abraded. Overfired?   |
| 1209    | 6             | 6          | FI2                       | MBA-IA    | Inc same ?overfired piece as 1208  |
| 1210    | 25            | 52         | FI2; Qs1                  | EIA       | Small red-coated angular bowl; shouldered vessel   |
| 1606    | 2             | 12         | Qs1                       | IA        |  |
| 1703    | 4             | 70         | FI3                       | LBA/EIA   | Shouldered jar with outturned neck, fingertipped. More likely LBA  |
| 1706    | 23            | 111        | FI2; FIQg2                | LBA/EIA   | Outturned neck, ?furrow decoration, burnishing. More likely LBA  |
| 1708    | 3             | 13         | FI2                       | MBA-IA    |  |
| 1710    | 3             | 32         | FI3, poorly sorted; Qslo1 | M Neo     | Peterborough Ware - Rim of Mortlake with birdbone impressions? Also highly abraded Qslo sherd with fingertip |
| 1712    | 2             | 21         | FI2                       | MBA-IA    |  |
| 1716    | 3             | 39         | FI2                       | MBA-IA    |  |
| 1718    | 3             | 19         | FI3; FI1                  | MBA-IA    | Burnished  |
| 1729    | 1             | 110        | FI2                       | MBA-IA    | Base   |
| 1731    | 3             | 43         | FI2                       | MBA-IA    |  |
| 1748    | 2             | 35         | FI2                       | LBA/EIA   | Vessel with outturned neck. More likely LBA  |
| 2703    | 2             | 11         | FI2                       | EIA       | Red coated   |
| 2709    | 5             | 26         | FI2                       | MBA-IA    |  |

| Context      | No. of sherds | Weight (g)  | Fabric | Spot-date | Comment   |
|--------------|---------------|-------------|--------|-----------|---|
| 2713         | 1             | 5           | FI2    | MBA-IA    |   |
| 2823         | 3             | 21          | FI2    | LBA/EIA   |   |
| 2904         | 1             | 4           | Qs1    | IA        |   |
| 2906         | 1             | 12          | FIQs2  | MBA-IA    |   |
| 2908         | 11            | 351         | FI2    | LBA/EIA   | Shouldered jar with outturned nec. Pedestal base. More likely LBA |
| 3103         | 1             | 20          | FI3    | LBA/EIA   | Shouldered or biconical jar                                       |
| 3116         | 1             | 5           | FI2    | MBA-IA    | Residual  |
| 3120         | 5             | 20          | FI2    | MBA-IA    |   |
| 4203         | 3             | 14          | FIQg2  | IA        | Residual  |
| <b>Total</b> | <b>142</b>    | <b>1414</b> |        |           |   |

Table 1: Prehistoric pottery

## B.2 Late Iron Age and Roman Pottery

By Edward Biddulph

### Introduction

B.2.1 A total of 125 sherds of pottery, weighing 1010g, was recovered from the evaluation. Each context-group was sorted into fabrics, which were quantified by sherd count and weight in grammes. Forms were identified by rim and quantified by minimum number of vessels (MV) and estimated vessel equivalents (EVE), which measure the surviving percentage of the rim circumference (thus, 0.25 EVE equals 25%). Fabrics were assigned codes devised by the Essex County Council Field Archaeology Unit (e.g., Biddulph *et al.* 2015). Forms were assigned OA codes. A summary of the pottery is provided in Table 2. The following fabrics were encountered (codes in brackets from Tomber and Dore 1998):

- BSW – Black-surfaced wares
- CGSW – Central Gaulish samian ware (LEZ SA 2)
- ESH – Early shell-tempered ware
- GROG – Grog-tempered ware (SOB GT)
- GROGRS – Red-surfaced grog-tempered ware
- GRF – Fine grey wares
- GRS – Sandy grey wares
- MICW – Miscellaneous Iron Age coarse tempered fabrics
- NKWO – North Kent white-slipped oxidized ware
- OXRC – Oxford red colour-coated ware (OXF RS)
- TSG – Indeterminate samian wares

B.2.2 In addition, the following forms were noted:

- C – jar
- CC – narrow-necked jar
- CH – bead-rimmed jar
- CM – wide-mouthed jar
- EA – butt-beaker
- HC – curving-sided bowl

| Context | Fabric | No. of sherds | Weight (g) | Type | EVE | Spot-date  |
|---------|--------|---------------|------------|------|-----|------------|
| 108     | GROGRS | 3             | 5          |      |     | AD 43-100  |
|         | BSW    | 1             | 2          |      |     |            |
| 110 (R) | CGSW   | 1             | 5          |      |     | AD 120-200 |
| 806     | GRS    | 1             | 5          |      |     | AD 43-410  |
| 1305    | BSW    | 2             | 6          |      |     | AD 43-100  |

LOWER THAMES CROSSING ARCHAEOLOGICAL EVALUATION REPORT LAND PARCEL 37 EAST TILBURY  
 LTC15TEV\_EVALUATION\_REPORT\_V1.1\_FINAL\_SL\_080121  
 DATE PUBLISHED - 02/07/2021  
 UNCONTROLLED WHEN PRINTED - COPYRIGHT © - 2020 - HIGHWAYS ENGLAND COMPANY LIMITED - ALL RIGHTS RESERVED

68

| Context      | Fabric | No. of sherds | Weight (g)  | Type                | EVE         | Spot-date    |
|--------------|--------|---------------|-------------|---------------------|-------------|--------------|
|              | OXRC   | 1             | 2           |                     |             | AD 350-410   |
| 1703         | GROGRS | 1             | 7           |                     |             | 50 BC-AD 100 |
| 1714         | ESH    | 1             | 5           |                     |             | 20 BC-AD 120 |
| 1728         | NKWO   | 1             | 38          |                     |             | AD 50-100    |
|              | ESH    | 2             | 30          |                     |             |              |
|              | GRF    | 1             | 32          |                     |             |              |
|              | BSW    | 1             | 17          |                     |             |              |
|              | ESH    | 1             | 9           |                     |             |              |
| 1731         | BSW    | 2             | 36          |                     |             | AD 43-410    |
| 1822         | GROG   | 7             | 179         |                     |             | 50 BC-AD 100 |
| 2703/2705    | TSG    | 1             | 18          | HC (Drag. 37 or 38) | 0.1         | AD 120-240   |
|              | MICW   | 3             | 31          |                     |             |              |
| 2808 (R)     | BSW    | 14            | 165         | CC                  | 0.2         | AD 43-100    |
|              | GROG   | 3             | 131         | CM                  | 0.15        |              |
|              | MICW   | 4             | 79          |                     |             |              |
| 2854 (R)     | BSW    | 2             | 19          | C                   | 0.05        | AD 43-100    |
| 2857         | BSW    | 2             | 12          |                     |             | AD 43-100    |
| 2858         | BSW    | 2             | 4           |                     |             | AD 43-100    |
|              | MICW   | 1             | 5           |                     |             |              |
| 2860         | ESH    | 1             | 8           |                     |             | 20 BC-AD 120 |
| 2865         | BSW    | 1             | 23          |                     |             | AD 43-100    |
| 2874         | BSW    | 2             | 29          | EA                  | 0.04        | AD 43-100    |
|              | ESH    | 62            | 99          | CH                  | 0.1         |              |
| 2880         | ESH    | 1             | 9           |                     |             | 20 BC-AD 120 |
| <b>Total</b> |        | <b>125</b>    | <b>1010</b> | <b>MV = 6</b>       | <b>0.64</b> |              |

Table 2: Quantification of the late Iron Age and Roman pottery by context (R = residual in post-Roman groups)

#### Assemblage composition

- B.2.3 Eleven sherds of pottery, representing 9% of the assemblage, belonged to context-groups spot-dated to the late Iron Age or early Roman period (c 50 BC-AD 100/120). The groups were recovered from Trenches 17, 18 and 28. The pottery comprised grog-tempered wares (GROG/GROGRS) and shell-tempered ware (ESH), both presumably of local origin. Shell-tempered pottery was manufactured at several locations in south Essex during the late Iron Age and early Roman period, for instance at Mucking (Jefferies and Lucy 2016, 179). No forms were identified by rim, but grog-tempered body sherds from cordoned or grooved high-shouldered necked jars (cf. Going 1987, type G19) were present.
- B.2.4 Some 105 sherds of pottery, accounting for 84% of the assemblage, were present in context-groups spot-dated to the early Roman period (c AD 43-100/120). The pottery was recovered from Trenches 1, 13, 17, and 28. Black-surfaced ware (BSW) was predominant. The ware comprised a range of medium and course sandy fabrics, often with additional grog inclusions, and is generally akin to fabrics recorded at Mucking (Jefferies and Lucy 2016, 158) and Going's (1987, 9) 'Romanizing grey wares' (fabric

45). A narrow-necked jar (CC) and a large butt-beaker (EA) were seen in this fabric. Grog-tempered (GROG) and shell-tempered (ESH) pottery continued to be deposited during this period; a wide-mouthed jar (CM) was recorded in the former, while a bead-rimmed jar (CH) was seen in the latter. Other pottery included North Kent white-slipped oxidised ware (NKWO), which arrived after AD 50, probably in the form of a flagon, and coarse sand-tempered fabrics of Iron Age tradition (MICW), which may be residual.

- B.2.5 Just four sherds came from context-groups spot-dated to the middle Roman period (c AD 120-240). The groups were recovered from Trenches 1 and 27 and are dated by the presence of samian wares (CGSW and TSG). A rim from a Drag. 37 or 38 bowl was recorded in fabric TSG. The vessel was manufactured in Central and East Gaulish workshops. Late Roman pottery was confined to a sherd of Oxford red colour-coated ware (OXRC), which was recovered from Trench 15. The form to which the sherd belonged cannot be identified.

#### **Chronological summary**

- B.2.6 The assemblage spans the late Iron Age and Roman period, but the emphasis is on the late Iron Age and early Roman period. Quite how early deposition commenced is uncertain. Early shell-tempered ware (ESH) is dated at Mucking from the early 1st century AD (Jefferies and Lucy 2016, 179), but the ware is attested in deposits dating to the late 1st century BC at Elms Farm, Heybridge (Biddulph *et al.* 2015). The presence of fabrics BSW and NKWO indicate deposition after c AD 43, and indeed after AD 50. However, deposition of this material may not have continued very far after c AD 70. Based on the pattern of pottery supply to sites such as Chelmsford and Elms Farm (Going 1987, 10; Biddulph *et al.* 2015), the use of grog tempering declined in the region after the mid-1st century AD, and it is worth noting that the amount of grog-tempered pottery in early Roman groups at Stanford Wharf Nature Reserve was negligible (Biddulph *et al.* 2012, table 5.2).
- B.2.7 Whether or not there was a hiatus in pottery deposition, the presence of samian (CGSW, TSG) and Oxford red colour-coated ware (OXRC) indicates deposition, albeit to a limited extent, during the mid- and late Roman periods. Fabric OXRC did not arrive in the region in any quantity before c AD 350, and so is indicative of deposition towards the end of the Roman period.

#### **Condition and distribution**

- B.2.8 The condition of the pottery is mixed. The mean sherd weight (MSW; weight divided by the number of sherds) is 8g, while the mean rim percentage or mean EVE (EVE divided by MV) is 0.11 EVE. This points to a generally fragmented assemblage of small sherds, although larger pieces were present; pottery from context 2808 was in relatively good condition with a MSW of 18g and mean EVE of 0.18. The condition of the pottery suggests that the assemblage had been subjected to several episodes of disturbance and redeposition after initial breakage and discard.
- B.2.9 Pottery was concentrated in trenches that targeted enclosure ditches and other settlement features, with the largest groups of pottery, as measured by sherd count, being recovered from central and south-western part of the settlement complex (Trenches 17 and 28). Pottery from Trenches 17, 18 and 27 was generally the 'best preserved', having above-average MSWs. These values suggest that the pottery in this area of the site was deposited relatively close to areas of pottery use.

**Status**

- B.2.10 The assemblage is too small to provide a reliable picture of site type or status, but the presence of regional and continental imports indicates that the inhabitants of the settlement used a relatively diverse range of pottery, with table wares, as well as more utilitarian forms represented, and that the settlement belonged to wider trade networks.

**Retention of material**

- B.2.11 In accordance with the recommendations of the SGRP (PCRG, SGRP, MPRG 2016), the assemblage should be retained in full both to integrate with the results of any further archaeological mitigation, and as it has value for comparison with other assemblages in future research.



## B.3 Medieval Pottery

By John Cotter

### Introduction

- B.3.1 A total of 26 sherds of medieval and post-medieval pottery weighing 267g were recovered from 12 contexts. Ordinary domestic wares were recovered.
- B.3.2 All the pottery was scanned during the present assessment and spot-dates were provided for each context. Each context group was quantified by sherd count and weight and recorded on a spot-dating spreadsheet. The condition of the sherds is mostly small and fragmentary, but a few fairly large and fresh sherds are also present.
- B.3.3 The context spot-date is the date-bracket during which the latest pottery types or fabrics are estimated to have been produced or were in general circulation. Comments on the range of fabrics were recorded, usually with mention of vessel form (jugs, bowls etc.) and any other attributes worthy of note (e.g., decoration etc.). Fabric codes referred to are those of the Museum of London (MoLA 2014). The range of pottery is described in some detail in the spreadsheet (Table 3) and is therefore only summarised below.

### Description

| Context | Spot-date    | Sherds | Weight (g) | Comments  |
|---------|--------------|--------|------------|---|
| 103     | c 1270-1550? | 1      | 2          | Small worn rim sherd. Plain everted/flaring rim possibly from jar or bowl? Fine sandy, micaceous, orange-red fabric with traces of clear brown glaze on lip of rim. Possibly Mill Green ware (Fabric 35) or a related industry? Or an early post-med redware (PMR)? Probably no later than 16C? |
| 110     | c 1100-1350  | 1      | 8          | Essex-type shelly-sandy ware (SSWX). Cooking pot with curved/flaring neck and simple beaded rim. Oxidised with grey core. Abundant coarse shell inclusions, sparse flint. Fresh   |
| 208     | c 1100-1350  | 2      | 8          | Essex-type shelly-sandy ware (SSWX). Fairly fresh body sherds from 2 cooking pots. Dark grey. Mainly sandy with sparse-moderate shell inclusions - mostly dissolved-out. Sooted ext.  |
| 604     | c 400-750    | 1      | 2          | Anglo-Saxon organic-tempered ware (CHAF). Small worn body sherd   |
| 706     | c 1175-1350? | 6      | 11         | 4x small sherds/scraps (3g) shelly-sandy ware (SSWX), probably from 1 cooking pot. 1x body sherd (3g) Anglo-Saxon organic-tempered ware (CHAF). 1x body sherd (7g) uncertain coarse grey sandy ware with sparse flint - possibly Essex medieval grey sandy ware (RCWX, c1175-1400)?             |
| 1207    | c 1680-1800  | 1      | 69         | Post-medieval redware (PMR). Storage jar with thick everted rim with internal lid seating and with large thumbled strip running under rim ext. Glossy reduced greenish-brown glaze  |

| Context      | Spot-date   | Sherds    | Weight (g) | Comments   |
|--------------|-------------|-----------|------------|--|
| 1505         | c 400-750   | 4         | 15         | Anglo-Saxon organic-tempered ware (CHAF). Probably 1 vessel? Body sherds. Largest is flattish (probably base) with traces of weak burnishing ext.  |
| 2104         | c 400-750   | 3         | 40         | Anglo-Saxon organic-tempered ware (CHAF). Probably 1 vessel? Fresh breaks. Jar with plain everted rim (diam c 140mm). Dense fabric. Oxidised brown ext. surface with dark grey core and int surface. Fresh, but rim chipped in antiquity   |
| 2808         | c 400-750   | 2         | 42         | Anglo-Saxon. 1x fresh body sherd (34g) in a sandy organic-tempered fabric (CHSF). This is from the neck/shoulder area of a jar decorated with a crudely incised lattice-like design covering most of the surviving body area. 1x body sherd (8g) in a similar organic-tempered fabric with some flint inclusions (CHSFL) |
| 2854         | c 400-750   | 1         | 7          | Anglo-Saxon. Body sherd in a sandy organic-tempered fabric (CHSF)  |
| 3116         | c 400-750   | 3         | 56         | Anglo-Saxon organic-tempered ware (CHAF). Fresh sherds. Includes plain everted rim from globular jar (diam c 120mm). Dense fabric with smoothed ext. surface. Body sherds from 2 other vessels. 1 burnished ext. and sooted int and ext.   |
| 4203         | c 1580-1750 | 1         | 7          | Body sherd in post-medieval black glazed redware (PMBL). Probably from a globular jug. Worn  |
| <b>TOTAL</b> |             | <b>26</b> | <b>267</b> |  |

Table 3. Description of post-Roman pottery by context

### Discussion

- B.3.4 The pottery mostly comprises ordinary domestic pottery typical of this part of south Essex and covers a date range from the early or mid-Saxon period through to the 18th century, though with many gaps evident.
- B.3.5 There is a small but significant presence of early to mid-Saxon hand-built pottery, all of it in organic-tempered ware (Fabric code: CHAF, etc). This includes the rims of two small jars and a shoulder/body sherd from another jar decorated with a crudely incised lattice-like scheme (context 2808). This type of decoration is unusual on pottery of this period. Organic-tempered ware has a broad date range in south-east England (mainly c 400-750 AD) and shows little or no typological change during the period. Decorated Anglo-Saxon pottery, however, is usually considered to be an early characteristic and mostly belongs to the later 5th and 6th centuries.
- B.3.6 A small number of later (post-Saxon) wares were also present. These include a few sherds of medieval shelly-sandy ware cooking pots (SSWX, c 1100-1350). The latest item in the assemblage is a decorated storage jar rim in glazed post-medieval red earthenware (PMR), which probably dates to c 1680-1800.

### Retention of material

- B.3.7 The pottery here has potential to inform research through re-analysis. The decorated Anglo-Saxon sherd is quite unusual and should be researched further. It should all

therefore be retained and properly catalogued and reported at some future date - alongside material from any subsequent formal excavations in this area.

## B.4 Flint

By Michael Donnelly

### Introduction

- B.4.1 A very small assemblage of eight struck flints and a larger assemblage of 102 fragments of burnt unworked flint weighing 3326g was recovered from the evaluation. The struck flint was widely scattered across several contexts, but the burnt material showed some marked concentrations around Trenches 17-18 and 27-28. The assemblage was largely undiagnostic, but at least one of the tools recovered was more typical of later prehistoric knapping. Overall, the assemblage indicates only very limited flint-related activity here, albeit with a more significant use of burnt flint cobbles/nodules for cooking/heating and other domestic activities.

| Context | Type            | Sub-type       | Notes  | Date |
|---------|-----------------|----------------|--|------|
| 103     | Knife<br>other  | Inner flake    | Probable knife with parallel invasive retouch ventral and dorsal upper left and use and misc. ventral trimming on right edge |      |
| 1203    | Burnt unworked  | Fragments x 9  | 142g   |      |
| 1305    | Flake           | Preparation    |  |      |
| 1312    | Irregular waste |                | Heavily burnt 3g   |      |
| 1703    | Burnt unworked  | Fragment x 1   | 3g   |      |
| 1706    | Burnt unworked  | Fragment x 1   | 2g   |      |
| 1709    | Burnt unworked  | Fragment x 1   | 9g   |      |
| 1810    | Piercer         | Inner flake    | Probable piercer with blunt retouched projection mid distal and edge damage/hafting damage left edges                        | ?LPH |
| 1810    | Burnt unworked  | Fragments x 2  | 1209g  |      |
| 1822    | Flake           | Side trimming  |  |      |
| 2705    | Burnt unworked  | Fragments x 23 | 307g   |      |
| 2715    | Burnt unworked  | Fragments x 24 | 89g  |      |
| 2800    | Flake           | Inner          |  |      |
| 2804    | Burnt unworked  | Fragment x 1   | 32g  |      |
| 2808    | Burnt unworked  | Fragments x 32 | 1314g  |      |
| 2857    | Burnt unworked  | Fragment x 1   | 4g   |      |
| 2858    | Burnt unworked  | Fragment x 1   | 2g   |      |
| 2874    | Flake           | Misc. trimming |  |      |
| 2874    | Burnt unworked  | Fragment x 1   | 13g  |      |
| 2908    | Burnt unworked  | Fragments x 3  | 199g   |      |
| 3116    | Blade           | Inner          | Hard-hammer struck and possibly not early in date  |      |

| Context | Type           | Sub-type     | Notes | Date |
|---------|----------------|--------------|-------|------|
| 3116    | Burnt unworked | Fragment x 1 | 1g    |      |

Table 4: Flints by context

- B.4.1 The struck flints were spread across Trenches 1, 13, 18, 28 and 31, with two flints each from Trenches 18 and 28 that both had dense concentrations of archaeological activity and numerous interventions. Trench 1 contained the knife found in context 106 while the piercer had come from Trench 18 context 1810 alongside some very large fragments of burnt unworked material. The single blade recovered originated from Trench 31, context 3116 and was found in a sample alongside a fragment of burnt unworked material. Overall, there is little to be said for the distribution pattern of this material.
- B.4.2 Burnt unworked fragments were found in seven trenches but with several marked concentrations. Trenches 17, 27 and 28 all had numerous instances of burnt flint (25 fragments weighing 1310g in context 2808), but these trenches also appeared to have a very high density of archaeological remains, and these concentrations may simply be a reflection of the level of investigation there.
- B.4.3 Some of the pieces were very large, 3 fragments from 2908 weighing 199g (av. 66.33g) and 2 fragments weighing 1209g in context 1810, and the size of the fragments could imply the use of very large cobbles/nodules in industrial processes rather than the use of smaller pebbles/cobbles for heating water. Alternatively, the larger flints may have been used for construction purposes and have been burnt indirectly, perhaps in an oven or a chimney surround, rather than being burnt intentionally to provide heat as part of that process.

#### Discussion

- B.4.4 The lithics recovered from this evaluation indicate only very limited flint-related activity here. There were two tools amongst only eight pieces but given the dispersed nature of the material this is probably a product of recovery bias. The flints are not diagnostic of date but appear more likely to be later prehistoric in date than early prehistoric; even the single blade form is a crude example such as can often be found alongside simple flake debitage in later industries.
- B.4.5 The concentrations of burnt material around Trenches 17-18 and 27-28 is perhaps more noteworthy, and the large size of some of the pieces perhaps suggests that an industrial rather than purely domestic function may account for them. These are most likely to be Bronze Age or later in date and most likely relate to Iron Age, Roman or Medieval use of flint for heating purposes or as construction material in kilns or other forms of industrial structure.
- B.4.6 While the scarcity of flint from the evaluation might suggest that any further works in this evaluation area are unlikely to encounter rich flint assemblages, the discovery of one Neolithic pit, and of colluvial deposits overlying the natural, means that discrete pits or pit clusters containing flintwork, and buried surfaces with *in situ* activity, may still be encountered in this area.

#### Methodology

- B.4.7 The artefacts were catalogued according to OA South's standard system of broad artefact/debitage type (Anderson-Whymark 2013; Bradley 1999), general condition noted and dating was attempted where possible. The assemblage was catalogued

directly onto an Open Office spreadsheet. During the assessment additional information on condition (rolled, abraded, fresh and degree of cortication), and state of the artefact (burnt, broken, or visibly utilised) was also recorded. Retouched pieces were classified according to standard morphological descriptions (e.g., Bamford 1985, 72-77; Healy 1988, 48-9; Bradley 1999). Technological attribute analysis was initially undertaken and included the recording of butt and termination type (Inizan *et al.* 1999), flake type (Harding 1990), hammer mode (Onhuma and Bergman 1982), and the presence of platform edge abrasion.

## B.5 Fired Clay

By Cynthia Poole

### Introduction

- B.5.1 A modest quantity of briquetage and fired clay amounting to 333 fragments weighing 2092g was recovered from eleven trenches, and was mainly concentrated in Trenches 12, 15-18 and 26-9. The assemblage consists of fairly small fragments with a mean fragment weight of 6g. The assemblage has been spot dated as far as is possible, but only a small number of pieces are sufficiently diagnostic to be firmly dated to the late Bronze Age, whilst other material is more consistent in character with Iron Age-Roman types. The assemblage is summarised in Table 5 below and has been recorded on an Excel spreadsheet in accordance with guidelines set out by the Archaeological Ceramic Building Materials Group (ACBMG 2007), which whilst not specifically for fired clay provide appropriate guidance. Fabrics were characterised on the basis of macroscopic features supplemented by the use of x20 hand lens for finer constituents.

### Fabrics

- B.5.2 The fabrics are composed of a fine sandy or silty clay occasionally containing small flint grit or clay pellets less than 4mm in size and is probably derived from local clay deposits. This forms the base for those with added organic/chaff temper. In general, the organic inclusions tended to be fairly fine and the very coarse chaff temper more typical of Roman briquetage appears to be absent. Colour covers the typical range of red, orange, brown and grey in varying shades and hues, but with a strong presence of cerise, purplish red and pink, that are typical of fired clay associated with salt working (or possibly made using salt marsh clay deposits). The only distinctive exception is the late Bronze Age perforated plate made in a coarse flint tempered fabric, typical of this form and related to pottery fabrics of this period.

### Description

- B.5.3 Much of the fired clay cannot be dated *per se* and is reliant on other dateable artefacts for phasing, which indicates a wide date range for features from the Neolithic to medieval period. A small number of items can be dated to the late Bronze Age and late Bronze Age/early Iron Age. The assemblage contains a significant quantity of material that can be classified as briquetage, which includes structural pieces, portable furniture and vessel sherds. Ceramic material and fired clay was used in salt production from the late Bronze Age through to the late Roman period.
- B.5.4 Structural material has few diagnostic features, as walls, lining or floors of hearths or ovens will have little more than a single moulded surface present and assigning pieces to this category is based on the general finish, often rougher than portable furniture, firing characteristics or by default. Material characterised as briquetage structure is based largely on colour and in some cases the presence of organic inclusions or the distinctive cream veneer rising from salt production and is often associated with other types of briquetage.
- B.5.5 Portable oven or hearth furniture is not especially well preserved but includes a variety of forms. The earliest object is a late Bronze Age perforated plate (ctxt 2804) made in a coarse flint tempered fabric of the same type as used for the contemporary pottery. The plate is of a type well known from the middle-lower Thames valley, its tributaries and the Thames Estuary, which has been analysed in some detail

(Champion 2014). The surviving fragment formed part of a rounded end joining to the start of straight grooved edge and has part of one perforation of 12mm diameter surviving. It measures 16-22mm thick and has a width of over 115mm, estimated to be about 190mm in total and length over 115mm. It is probable that it had at least four perforations and possibly more, suggesting a length at least that of the width. It was associated with a thin flat sherd that is probably pottery rather than fired clay, which appeared to be overfired with vesicular cindering and small bulbous blown areas. The possibility of an association with pottery production is of interest as a use in pottery production was rejected by Champion (ibid, 287-90) in favour of domestic cooking. It could however be argued that the sherd is refired rather than overfired, which would not rule out a straightforward domestic use. Other fired clay from the context was made in the local sandy clay fabric and largely indeterminate in form, but most probably oven/hearth structure.

- B.5.6 Other items of furniture are of Iron Age or Roman date. None are particularly well preserved but include a possible oven plate 30mm thick found in pit or SFB 1610, a cylindrical rod or firebar 33mm in diameter (ctxt 1505), a rectangular firebar or pedestal 41 by 55mm wide (ctxt 2904) and a cylindrical pedestal or firebar 60mm in diameter (ctxt 2703).
- B.5.7 Briquetage vessels include a few late Bronze Age forms which comprise part of the stem of spatulate end cup pedestals and a possible fragment of cup pedestal from the junction of cup and stem (ctxts 1731, 2606). Comparable items have been found in a late Bronze Age context at Mucking, Essex (Jones 1977, Barford 1985). Other items of briquetage include fragments of chaff tempered flat plates or vessels measuring 16mm thick (ctxts 1703, 1706, 1708, 1710), with a straight edge where this survived: it is uncertain whether these are thin plates or thick-walled evaporating containers possibly similar to those found on the A2 in North Kent (Morris 2012, 233-7) in early and middle Iron Age contexts. The majority of briquetage vessel sherds were thin-walled, measuring from 3-5mm up to 7-12mm thick, though most were less than 9mm. These included some base sherds (ctxt 1712) which had diameters of c 80 and 90mm, a flat pressed base, shallow flaring sides and a pinched angle at the junction of walls and base. Rim sherds (ctxt 2908) were similar to some from the A2 (ibid. Figs 3.65 & 3.66, nos. 3, 4 & 6) and indicated a diameter of at least 130mm, though this was difficult to gauge from the small size and irregularity of the sherds. Some pieces appeared to form a rounded corner suggesting these may derive from rectangular troughs rather than bowl like forms. Pottery associated with these vessels is mainly dated middle Bronze Age-Iron Age, but in some cases Roman and Saxon pottery is also present, or is the only pottery present, and in these contexts (1731, 2703, 2705, 2808) it is likely that the briquetage is residual. Only a proportion of sherds had the cream veneer commonly associated with salt production and it is likely some of the sherds represent salt moulds, rather than evaporating vessels.

| Context | Spot date | No. | Weight (g) | Material   | Comments                               |
|---------|-----------|-----|------------|------------|--|
| 103     |           | 14  | 81         | Fired clay | Indeterminate / Structural             |
| 110     |           | 5   | 80         | Fired clay | Wattle supported structure; ?furniture |
| 210     |           | 8   | 3          | Fired clay | Indeterminate                          |
| 804     | Med-Pmed  | 1   | 16         | CBM        | Flat roof tile (?peg tile)             |



| Context      | Spot date | No.        | Weight (g)  | Material                    | Comments   |
|--------------|-----------|------------|-------------|-----------------------------|--|
| 1203         | LBA-RB    | 38         | 66          | Briquetage, Fired clay,     | Briquetage evaporating vessel sherds; salt working, ?hearth structure; indeterminate furniture |
| 1205         |           | 1          | 3           | Fired clay                  | Structural - wattle impression   |
| 1207         | Med-Pmed  | 1          | 47          | CBM                         | Flat roof tile (?peg tile)   |
| 1210         |           | 10         | 24          | Fired clay                  | ?structural, small stem impressions  |
| 1218         |           | 15         | 8           | Fired clay                  | Indeterminate  |
| 1312         |           | 1          | 18          | Fired clay                  | Indeterminate  |
| 1505         | RB        | 2          | 274         | Fired clay, CBM             | Cylindrical rod (?firebar/pedestal); Roman brick   |
| 1606         | IA-RB     | 9          | 58          | Briquetage                  | Firebar/pedestal, vessels  |
| 1611         | LBA-RB    | 5          | 36          | Briquetage /Fired clay      | Briquetage vessel sherds; flat plate/disc  |
| 1703         | IA-RB     | 1          | 6           | Briquetage                  | Edge of straight sided flat plate  |
| 1706         | IA-RB     | 19         | 90          | Briquetage                  | Vessel sherds, plate and indeterminate   |
| 1708         | LBA-RB    | 4          | 19          | Briquetage                  | Vessel sherds, plate and indeterminate   |
| 1710         | LBA-RB    | 2          | 6           | Briquetage                  | Vessel/plate edge fragment   |
| 1712         | LBA-RB    | 39         | 98          | Briquetage                  | Vessel sherds; clay fragment with stem voids – ?fuel waste                                     |
| 1731         | LBA       | 8          | 44          | Briquetage                  | Vessel sherds, spatulate cup pedestal; ?structure  |
| 1805         |           | 4          | 11          | Fired clay                  | Indeterminate  |
| 1807         | IA-RB     | 3          | 25          | Fired clay                  | Structural?  |
| 1810         | IA-RB     | 26         | 82          | Briquetage, Fired clay, CBM | Briquetage vessel sherds; ?prop/support; brick corner/kiln bar?                                |
| 2606         | LBA?      | 1          | 31          | Briquetage                  | ?Furniture - cup pedestal  |
| 2703         | LBA-RB    | 18         | 120         | Briquetage                  | Vessel sherds, pedestal, hearth/oven lining  |
| 2705         | LBA-RB    | 9          | 26          | Briquetage                  | Vessel sherds, furniture/structure   |
| 2804         | LBA       | 10         | 262         | Fired clay                  | LBA perforated disc; structural; ?pottery waster   |
| 2808         | IA-RB     | 16         | 57          | Briquetage, Fired clay,     | Vessel sherds; structural/furniture  |
| 2856         |           | 1          | 35          | Fired clay                  | ?Structural  |
| 2858         |           | 1          | 13          | Fired clay                  | ?Structural  |
| 2874         |           | 8          | 7           | Fired clay                  | ?Structural  |
| 2880         |           | 32         | 288         | Fired clay/ briquetage      | ?Hearth structure: flat slab with cream residue and a few small wattle impressions             |
| 2904         | IA-RB     | 8          | 104         | Briquetage, Fired clay,     | Vessel sherds; firebar/pedestal  |
| 2906         | LBA-RB    | 11         | 35          | Briquetage, Fired clay,     | Vessel sherds; indeterminate   |
| 2908         | LBA-RB    | 2          | 19          | Briquetage                  | Vessel   |
| <b>Total</b> |           | <b>333</b> | <b>2092</b> |                             |  |

Table 5: Summary of briquetage, fired clay and CBM assemblage

## Conclusion

- B.5.8 The fired clay has produced evidence of domestic activity and salt working from the late Bronze Age through to the Roman period. Domestic activity is represented by general oven and hearth structure and possibly some portable furniture, but the overriding emphasis is on salt production. This includes evidence of material used in the evaporation process as well as probably packaging the salt in moulds. The quantities suggest this was carried out on a relatively small scale at the level of a family run cottage industry, rather than on the industrial scale exemplified by 'red hill' sites of Essex, such as found at Stanhope Wharf (Biddulph *et al.* 2012). The quantities suggest the industry supplied the needs of the local community and perhaps traded with some inland settlements.

## Recommendations

- B.5.9 The assemblage, though relatively small and not especially well preserved, contains a range of material of varying date and function, which is significant in understanding activity on the site and has further research potential in relation to the site and comparative material from the region. It is recommended that all of the briquetage is retained, together with any other identifiable forms and that the indeterminate fragments may be discarded, if desired at completion of the project.

## B.6 Ceramic Building Material

By Ruth Shaffrey

### Introduction

- B.6.1 A total of 16 fragments of ceramic building material (CBM) weighing 513g were retained and submitted for analysis. The CBM has been recorded and details have been entered into a Microsoft Excel spreadsheet, which can be found in the archive. Fabric was recorded for all CBM except small fragments of indeterminate form.
- B.6.2 The small assemblage of CBM comprises fragments of flat tile and one possible brick, but none are sufficiently complete for any further interpretation. They are all made of either a silty orange fabric or a hard, red sandy fabric. The fabric types suggest a Roman date.

| Ctx          | Wt (g)     | Form               | Fabric                                    |
|--------------|------------|--------------------|---|
| 804          | 16         | Flat               | Hard red fabric with coarse moulding sand |
| 1207         | 47         | Flat               | Orange silty fabric                       |
| 1312         | 18         | Indeterminate      | Red sandy fabric                          |
| 1505         | 251        | Brick/flat         | Overfired hard red                        |
| 1606         | 54         | Flat/indeterminate | Orange silty fabric                       |
| 1703         | 6          | Indeterminate      |   |
| 1805         | 11         | Indeterminate      |   |
| 1810         | 61         | Flat/indeterminate | Hard red sandy fabric                     |
| 2705         | 49         | Flat               | Orange silty fabric                       |
| <b>Total</b> | <b>513</b> |                    |   |

Table 6: summary of CBM forms

### Retention

- B.6.3 A sample of the CBM fabric types should be retained. Full details of CBM recommended for discard/retention can be found in the Excel spreadsheet.

## B.7 Metals

By Anni Byard

### Introduction and methodology

- B.7.1 Seven iron objects weighing a total of 56.5g were recovered from the site during evaluation. Finds were scanned during the present assessment and where possible broad period dates were assigned. Objects were quantified by type count and weight by context and recorded on a spreadsheet.

### Description

| Context      | Material | No.      | Weight (g)  | Object | Date | Description  |
|--------------|----------|----------|-------------|--------|------|--|
| 110          | Fe       | 4        | 15.1        | Misc   |      | Four amorphous fragments of iron   |
| 110          | Fe       | 1        | 19.1        | Knife  | PM?  | Section of a knife blade (59mm L, 7.7mm W, 18.4mm D), probably of post-medieval or early modern date |
| 1203         | Fe       | 2        | 22.3        | Query  | PM?  | Two iron bars of tapering rectangular section, possible nails or brads. Encrusted.                   |
| <b>Total</b> |          | <b>7</b> | <b>56.5</b> |        |      |  |

Table 7. Description of metalwork by context

### Discussion

- B.7.2 The only identifiable object is a section of a knife blade from context 110. It is well made and quite thick and is likely to be of post-medieval or early modern date, although an earlier date cannot be ruled out. The iron bars may be large nails or brads, but they are encrusted and incomplete. A post-medieval / early modern date is likely.

### Retention of material

- B.7.3 The metalwork has been recorded and holds no intrinsic value for comparative analysis so should not be retained.

## B.8 Worked Stone

By Ruth Shaffrey

### Introduction

- B.8.1 A total of 19 pieces of stone were retained and submitted for analysis. These were examined with a x10 magnification hand lens for signs of use. Worked or utilised items were recorded (Table 8) and details entered into a Microsoft Excel spreadsheet.
- B.8.2 A total of 15 fragments of Mayen lava weighing 384g were recovered from three contexts (106, 110, 3116). These are too degraded for anything to be said about their form but as Mayen lava is only known to have been imported for use as rotary querns, it is assumed that this was their function. It is likely that they are of Roman date, because these were first introduced into Britain at the time of the Roman conquest, but they continued to be used in the Saxon and medieval periods, so Saxon or medieval dates are also possible. The rest of the stone is unworked and has not been used.
- B.8.3 All the unworked stone can be discarded but the lava fragments should be retained in case of future geochemical or petrographic analysis.

| Context      | No.       | Weight (g) | Type       |
|--------------|-----------|------------|------------|
| 106          | 1         | 175        | Lava quern |
| 110          | 3         | 151        | Lava quern |
| 3116         | 11        | 58         | Lava quern |
| <b>Total</b> | <b>15</b> | <b>384</b> |            |

Table 8: details of worked stone

### C.1 Environmental Samples

By Richard Palmer

#### Introduction

- C.1.1 Seven bulk samples were taken as part of the evaluation, primarily for the retrieval and assessment of charred plant remains (CPR) and the recovery of bones and artefacts.

#### Method

- C.1.2 The samples were processed in their entirety at Oxford Archaeology using a modified Siraf-type water flotation machine. The flots were collected in a 250µm mesh and residues in a 500µm mesh and dried. The residue fractions were sorted by eye and with the aid of a magnet while the flot material was sorted using a low power (x10) binocular microscope to extract cereal grains and chaff, smaller seeds and other quantifiable remains.

#### Results

- C.1.3 Summarised data on the samples and flot assessment is presented in Table 9.
- C.1.4 Sample 1 from fill 1203 of pit 1202 produced a large though root dominated flot. Several wheat grains (*Triticum* sp.) were recovered but are in very poor condition. Recovered glume bases are also in very poor condition. Fragments of hazelnut shell (*Corylus avellana*) are also present. Pottery, bone and iron were extracted from the residue.
- C.1.5 Sample 2 from fill 1810 of ditch 1808 produced a limited flot. All recovered material is in poor condition and the grain is indeterminate. Pottery and fired clay were recovered from the residue.
- C.1.6 Sample 3 from fill 2705 of ditch 2704 also produced a limited flot. Recovered charcoal fragments are small (<4mm) and the grain is in poor condition and consequently indeterminate. Bone, pottery, fired clay and burnt stone were recovered from the residue.
- C.1.7 Sample 4 from fill 2715 of posthole 2714 produced a poor flot. All recovered material is <4mm in size and includes highly vitrified and clinker-like material. Pottery, bone and burnt stone were recovered from the residue.
- C.1.8 Sample 5 from fill 3116 of pit 3115 produced a limited flot. Some of the charcoal is ring porous and the grain is possibly wheat. Bone and pottery were recovered from the residue.
- C.1.9 Sample 7 from fill 2804 of posthole 2803 produced a poor flot. Most of the recovered grain is damaged or fragmented with the more intact specimens being wheat. Speedwell seeds (*Veronica* sp.) are also present. Pottery and burnt stone were recovered from the residue.
- C.1.10 Sample 8 from fill 2808 of pit 2807 produced a limited flot. Some of the recovered charcoal is ring porous and the grain is a mix of wheat and barley (*Hordeum vulgare*).

Dock seeds (*Rumex* sp.) are also present. Bone, pottery, fired clay and burnt stone were all recovered from the residue.

**Discussion**

- C.1.11 In general, the results from these samples may indicate that there is generally quite limited potential for the recovery of charred material on site, but it is worth noting that while features dated as Roman and Anglo-Saxon produced very few charred remains the sample from prehistoric pit 1202 produced both grain and cereal chaff as well as charcoal from what was only a 20L sample.
- C.1.12 The interpretative value of the material recovered at this stage of work is limited both due to the small quantities of material recovered and the overall poor condition of the charred remains which hindered species identification in many cases. A few samples may offer potential for radiocarbon dating but with such scant remains the possibility that charred remains are residual or intrusive would need to be considered.

**Recommendations for retention/dispersal**

- C.1.13 The flots warrant retention until all works on site are complete but it is not expected that further work will be required. Retention in the archive is not considered a priority at this stage.

| Sample no. | Context no. | Trench | Feature/Depo sit | Date (AD) | Sample vol. (L) | Flot vol. (ml) | Charcoal >2mm | Grain | Chaff | Weeds | Molluscs | Other | Soil description, including predominant Munsell soil colour |
|------------|-------------|--------|------------------|-----------|-----------------|----------------|---------------|-------|-------|-------|----------|-------|---|
| 1          | 1203        | 12     | 1202             | LBA/EIA   | 20              | 75             | +++           | +     | ++    | +     |          | +     | 7.5YR 4/4 loamy sand  |
| 2          | 1810        | 18     | 1808             | U/D       | 40              | 10             | ++            | +     | +     |       |          |       | 7.5YR 4/6 sandy loam  |
| 3          | 2705        | 27     | 2704             | c 120-240 | 40              | 50             | ++            | +     | +     |       |          |       | 7.5YR 3/2 silt loam   |
| 4          | 2715        | 27     | 2714             | U/D       | 20              | 10             | +             |       |       | +     |          |       | 7.5YR 2.5/3 sandy silt loam                                 |
| 5          | 3116        | 31     | 3115             | c 400-750 | 40              | 20             | ++            | +     |       |       |          |       | 10YR 4/4 sandy loam   |
| 7          | 2804        | 28     | 2803             | U/D       | 10              | 10             | +             | ++    | +     | +     |          |       | 10YR 3/3 sandy loam   |
| 8          | 2808        | 28     | 2807             | c 400-750 | 40              | 40             | ++            | +     | +     | +     |          |       | 10YR 3/3 sandy silt loam                                    |

Key: +=present (up to 5 items), ++=frequent (5-25), +++=common (25-100), ++++=abundant (100+).

Table 9: Assessment of bulk (CPR) samples.

## C.2 Animal Bone

By Rebecca Nicholson

### Introduction

- C.2.1 A total of 516 animal bone fragments weighing 3.56kg was recovered from the site, most of which were collected by hand. Of these, 182 fragments have been identified to skeletal element and species or wider taxonomic group (Table 10). Environmental samples were sieved at 10mm, 4mm, 2mm and 0.5mm fractions: these produced 41 bone fragments only a small number of which were identifiable specimens. Features on the site were dated based on associated ceramic finds.
- C.2.2 The animal bone assemblage was recorded with the aid of the Oxford Archaeology skeletal reference collection and standard identification guides, using a diagnostic zone system for the more intact specimens (Serjeantson 1996). Bone condition was recorded on a semi-quantitative scale of 1 (as fresh) to 5 (extremely poor, corroded and crumbly). Where condition was difficult to score (e.g., burnt bone and teeth) condition was recorded as 0 (Blank in Fig 19). Few bones were complete enough to permit measurement, but where possible these are available in archive and follow von den Driesch 1976. Tooth wear was recorded following Grant (1982). Full records will be available with the site archive.

### Description

- C.2.3 Bone preservation varies depending on trench and period (Fig. 19), but was typically fairly good (score 2-3), but with no clear relationship to the age of the bone (i.e., some prehistoric bone was as well-preserved as some medieval specimens). The bone in poorest condition was mostly from Trenches 27-29. Several bones had been gnawed by a carnivore (contexts 1203, 1606, 1728 and 2808). The identifiable bone mostly derived from cattle and sheep/goat with a few bones from horse, pig and, from Neolithic pit fill 1710 and Anglo-Saxon pit fill 2808, unidentified bird. Micro-mammal bones were restricted to a single vertebra from one of the sieved samples.
- C.2.4 Cattle (*Bos taurus*) is the most common domestic animal identified, present in every main period (Table 10), with sheep/goat present only from the early Romano-British and later periods and pig only recorded in Late Iron Age and early Romano-British contexts. Horse bones included a fragmented mandible in Iron Age primary ditch fill 2904, a scapula in undated pit fill 1611 and a fragment of distal humerus, probably horse, on gravel patch 904.
- C.2.5 There is very little butchery evidence, although high levels of fragmentation in a couple of some contexts may reflect the smashing of long bones for marrow in some cases, but levels of bone preservation are not sufficient to draw definitive conclusions. No obvious pathologies were observed.
- C.2.6 Most of the ageing information comes from fusion data and where ages could be extrapolated using Habermehl (1975), most are fused and indicative of adult animals, but a large mammal vertebra from 1739 and a medium mammal vertebra from context 2858 were unfused. An unfused sheep/goat distal metacarpal from 2804 and an unfused pig metapodial from 1728 indicate animals of under 2 years old. Only two mandibles provide aging information: a cattle mandible from ditch fill 1305 has an estimated mean wear stage of 41 (based on Grant 1982) and a sheep/goat mandible



from pit fill 2808 has a mean wear stage of 44, in both cases indicative of an old adult or elderly animal.

**Conclusions**

- C.2.7 Bone is clearly present in the areas excavated, and in some trenches is well preserved.
- C.2.8 The assemblage has been fully recorded, and while little can be read into such a small assemblage the results would be worth considering alongside any future excavations at the site.

**Retention of material**

- C.2.9 The assemblage should be retained to be considered alongside that from any future excavations at the site.

|               | M. Neo   | MBA/IA    | LBA/EIA   | EIA       | IA        | LIA/ERB   | ERB       | Romano-British | Anglo-Sax | Medieval  | U/D       | Total      |
|---------------|----------|-----------|-----------|-----------|-----------|-----------|-----------|----------------|-----------|-----------|-----------|------------|
| Cattle        |          | 1         | 5         | 1         |           |           | 2         | 3              | 1         |           | 2         | 15         |
| Horse         |          |           |           |           | 8         |           |           |                |           |           | 1         | 9          |
| Horse?        |          |           |           |           |           |           |           |                |           |           | 2         | 2          |
| Sheep/goat    |          |           |           |           |           |           | 1         | 3              | 5         |           | 2         | 11         |
| Sheep/goat?   |          |           |           |           |           |           |           |                | 1         |           |           | 1          |
| Pig           |          |           |           |           |           | 1         | 1         |                |           |           |           | 2          |
| Large mammal  |          | 15        | 4         | 57        | 6         |           | 90        | 40             | 6         | 1         | 47        | 266        |
| Medium mammal |          | 1         | 2         |           |           | 1         |           | 6              | 13        | 29        | 2         | 54         |
| Micromammal   |          |           |           |           |           |           |           |                | 1         |           |           | 1          |
| Mammal indet  | 3        | 20        | 35        |           |           | 26        |           | 25             | 28        | 15        | 1         | 153        |
| Bird          | 1        |           |           |           |           |           |           |                | 1         |           |           | 2          |
| <b>Total</b>  | <b>4</b> | <b>37</b> | <b>46</b> | <b>58</b> | <b>14</b> | <b>28</b> | <b>94</b> | <b>77</b>      | <b>56</b> | <b>45</b> | <b>57</b> | <b>516</b> |

Table 10: Number of specimens (NSP) by period

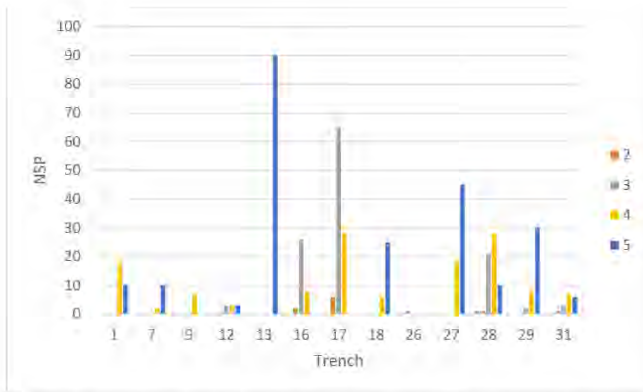

Figure 19: Condition of animal bone specimens (1:as fresh – 5:extremely poor, corroded and crumbly) in each trench. Note that the large number of fragments in category 5 reflects the very crumbly nature of the bone: bones in this category are typically small fragments from a larger bone.

| Context | Number of Fragments | Weight (g) hand collected | Weight (g) sieved |
|---------|---------------------|---------------------------|-------------------|
| 103     | 10                  | 3                         |                   |
| 110     | 18                  | 20                        |                   |
| 706     | 17                  | 36                        |                   |
| 904     | 7                   | 37                        |                   |
| 1203    | 8                   |                           | 4                 |
| 1213    | 1                   | 112                       |                   |
| 1305    | 90                  | 163                       |                   |
| 1606    | 8                   | 35                        |                   |
| 1611    | 27                  | 380                       |                   |
| 1622    | 1                   | 14                        |                   |
| 1703    | 2                   | 408                       |                   |
| 1708    | 36                  | 25                        |                   |
| 1710    | 4                   | 3                         |                   |
| 1716    | 1                   | 78                        |                   |
| 1728    | 4                   | 295                       |                   |
| 1731    | 51                  | 157                       |                   |
| 1739    | 2                   | 29                        | 2                 |
| 1810    | 10                  | 26                        |                   |
| 1822    | 21                  | 17                        |                   |
| 2606    | 1                   | 194                       |                   |
| 2703    | 58                  | 139                       | 5                 |
| 2705    | 5                   |                           | 1                 |
| 2715    | 1                   | 14                        |                   |
| 2804    | 1                   | 321                       | 23                |
| 2808    | 40                  | 30                        |                   |
| 2820    | 16                  | 2                         |                   |
| 2857    | 1                   | 5                         |                   |
| 2858    | 1                   | 8                         |                   |
| 2860    | 1                   | 26                        |                   |
| 2880    | 5                   | 163                       |                   |
| 2904    | 14                  | 221                       |                   |
| 2908    | 37                  | 52                        | 6                 |

| Context | Number of Fragments | Weight (g) hand collected | Weight (g) sieved |
|---------|---------------------|---------------------------|-------------------|
| 3116    | 16                  | 2                         |                   |
| 3122    | 1                   | 3                         |                   |
| 103     | 10                  | 20                        |                   |

Table 11: Total number of specimens and weight of specimens from each context.

## Appendix D      References

---

- ACBMG, 2007 Ceramic building material, minimum standards for recovery, curation, analysis and publication
- Anderson-Whymark, H, 2013 The flint in, T Allen, A Barclay, A M Cromarty, H Anderson-Whymark, A Parker, M Robinson, and G Jones, *Opening the wood, making the Land; The Archaeology of a Middle Thames Landscape, Mesolithic, Neolithic and Bronze Age, Vol 1*, Oxford: Oxford Archaeological Unit. Thames Valley Landscapes Monograph **38**
- Bamford, H, 1985 *Briar Hill: excavation 1974-1978*, Northampton: Northampton Development Corporation. Archaeological monograph **3**
- Barford, P M, 1985 Salt Production in Essex before the Red Hills, in A J Fawn, K A Evans, I McMaster & G M R Davies *The Red Hills of Essex Salt-making in Antiquity*, Colchester Archaeology Group
- Biddulph, E, Compton, J, and Martin, T S, 2015 The late Iron Age and Roman pottery, in M Atkinson and S J Preston, Heybridge: A late Iron Age and Roman settlement: Excavations at Elms Farm 1993-5, *Internet Archaeology* **40**, <http://dx.doi.org/10.11141/ia.40.1.biddulph1>
- Biddulph, E, Foreman, S, Stafford, E, Stansbie, D, and Nicholson, R, 2012 *London Gateway. Iron Age and Roman salt making in the Thames Estuary. Excavations at Stanford Wharf Nature Reserve, Essex*, Oxford Archaeology Monograph **18**, Oxford
- Booth, P, nd Oxford Archaeology Roman pottery recording system: an introduction, unpublished, updated November 2019
- Bradley, P, 1999 The worked flint. In A Barclay and C Halpin (eds) *Excavations at Barrow Hills, Radley, Oxfordshire*, Oxford: Oxford Archaeological Unit. Thames Valley Landscapes Monograph **11**: 211-227
- Brudenell, M, 2016 Middle Iron Age Pottery, in C Evans, G Appleby and S Lucy, with J Appleby and M Brudenell, *Lives in the Land. Mucking Excavations by Margaret and Tom Jones, 1965-1978: Prehistoric, Context and Summary*, Oxbow Books, 365-93
- Champion, T, 2014 Food, Technology and Culture in the Late Bronze Age of Southern Britain: Perforated Clay Plates of the Lower Thames Valley, *Proc. Prehist. Soc.* **80**, 2014, 279-98
- Evans, C, Appleby, G, and Lucy, S, 2016 *Lives in the Land: Mucking Excavations by Margaret and Tom Jones, 1965-1978*, Prehistory: context and summary
- Going, C J, 1987 *The Mansio and other sites in the south-eastern sector of the Caesaromagus: The Roman pottery*, CBA Res Rep **62**, London

- Grant, A, 1982 The use of toothwear as a guide to the age of domestic ungulates, in B Wilson, C Grigson and S Payne (eds) *Ageing and sexing animal bones from archaeological sites*, BAR Brit. Ser. **109**, 91-108, Oxford
- Habermehl, K-H, 1975 *Die Altersbestimmung bei Haus- und Labortieren*, 2nd ed. Berlin, Hamburg
- Harding, P, 1990 The worked flint, in J C Richards (ed) *The Stonehenge environs project*, London, English Heritage
- Healy, F, 1988 *The Anglo-Saxon Cemetery at Spong Hill, North Elmham, Part VI: Occupation during the seventh to second Millennia BC*, East Anglian Archaeological reports **38**
- Historic England, 2015 *Management of Research Projects in the Historic Environment: The MoRPHE Project Managers' Guide*, Swindon: Centre for Archaeology Guidelines.
- Highways England, 2018 Lower Thames Crossing: A Scheme Wide Specification for Archaeological Trial Trenching: unpublished document HE540039-CJV-GEN-GEN-SPE-HER-00001draft, Revision 1.05.
- Inizan, M-L, Reduron-Ballinger, M, Roche, H and Tixier, J, 1999 *Technology and terminology of knapped stone*, Cercle de Recherches et d'Etudes Préhistoriques, CNRS, Nanterre
- Jefferies, R, and Lucy, S, 2016 Romano-British pottery, in S Lucy and C Evans *Romano-British settlement and cemeteries. Mucking excavations by Margaret and Tom Jones 1965-1978*, Oxford, 154-99
- Jones, M U, 1977 Prehistoric salt equipment from a pit at Mucking, Essex, *Antiq J* **57**, ii, 317-9& Pl.LVI
- Lucy, S and Evans, C, 2016 *Romano-British Settlement & Cemeteries. Mucking Excavations by Margaret and Tom Jones 1965-1978*. CAU Landscape Archives Series (No.3/Mucking 5).
- MoLA, 2014 London medieval and post-medieval pottery codes, Museum of London Archaeology, <http://www.mola.org.uk/medieval-and-post-medieval-pottery-codes> (Accessed 11 Jan 2019)
- Morris, E, 2012 Briquetage, in T Allen, M Donnelly, A Hardy, C Hayden and K Powell, *A Rod through the Past Archaeological discoveries on the A2 Pepperhill to Cobham road-scheme in Kent*, Oxford Archaeology monograph **16**
- Onhuma, K and Bergman, C A, 1982 Experimental studies in the determination of flake mode, *Bulletin of the Institute of Archaeology, London* **19**, 161-171
- Oxford Archaeology, 2019a Lower Thames Crossing Scheme-wide Written Scheme of Investigation for Trial Trenching south of the River Thames, unpublished document prepared for Lower Thames Crossing on behalf of Balfour Beatty

- Oxford Archaeology, 2019b Lower Thames Crossing Scheme-wide Written Scheme of Investigation for Trial Trenching north of the River Thames. unpublished document prepared for Lower Thames Crossing on behalf of Balfour Beatty
- Oxford Archaeology, 2020 Lower Thames Crossing Detailed Written Scheme of Investigation for Trial Trenching of Land Parcels 15, 16, 17 and 37, unpublished document prepared for Lower Thames Crossing on behalf of Balfour Beatty
- PCRG, SGRP, MPRG, 2016 *A standard for pottery studies in archaeology*, Prehistoric Ceramics Research Group, Study Group for Roman Pottery, and the Medieval Pottery Research Group
- Place Services, 2019 *Lower Thames Crossing Aerial Investigation and Mapping Report*. Essex County Council.
- Serjeantson, D, 1996 Animal Bone, in S Needham and T Spence (eds) *Runnymede Bridge Research Excavations, Volume 2: Refuse and Disposal at Area 16 East, Runnymede*. London : British Museum Press. pp.194–223.
- Tomber, R and Dore, J, 1998 *The National Roman fabric reference collection: a handbook*, MoLAS Monograph 2, London
- von den Driesch, A, 1976 *A guide to the measurement of animal bones from archaeological sites*, Harvard University.

## Appendix E Abbreviations and Glossary

---

**ADS** Archaeology Data Service. Digital archaeological archive

**CDM** Construction Design Manual. Health and safety guidance for the construction industry

**CPD** Continuing Professional Development

**CIfA** Chartered Institute for Archaeologists

**DBA** Desk Based Assessment. Detailed assessment of archaeology and other aspects of the historic environment

**DCO** Development Consent Order

**EIA** Environmental Impact Assessment. Detailed study of environmental impacts as directed under the Town and Country Planning (Environmental Impact Assessment) Regulations 2017 following on from EU Directive EIA Directive (85/337/EEC)

**ES** Environmental Statement. The principal environmental report detailing environmental impacts within an EIA

**GPS** Global Positioning System

**HER** Historic Environment Record

**LTC** Lower Thames Crossing

**MCIfA** Member of the Chartered Institute for Archaeologists

**MoRPHE** Management of Research Projects in the Historic Environment

**NMP** National Mapping Programme. A study of aerial photographs and digitisation of resulting data into GIS. Originally funded by Historic England

**OASIS** Online Access to the Index of archaeological investigations.  
The OASIS project brings together a number of strategic partners: the Archaeology Data Service, Historic England, Historic Environment Scotland, and the Royal Commission on the Ancient and Historical Monuments of Wales under the umbrella of the University of York

**OCN** Old County Number. Historic England's reference for material that is not readily-available online and may represent historic archaeological work that consists of paper archives or has yet to be formally reported on

**PINS** Planning Inspectorate

**RAMS** Risk Assessment Method Statement

**SMC** Scheduled monument consent

**TDR** Trusted Digital Repository

**UKIC** United Kingdom Institute for Conservation

**WSI** Written Project of Investigation. A detailed method statement for archaeological work

**WSL – Western Southern Link**  
The Western Southern Link (WSL) is an alternative for Short List Routes 2, 3 and 4 to the south of the River Thames.

## Appendix F Site Summary

|                           |  |
|---------------------------|--|
| <b>Site name:</b>         | Lower Thames Crossing Land Parcel 37, Land at East Tilbury,<br>Essex |
| <b>Site code:</b>         | LTC15T20   |
| <b>Grid Reference</b>     | centred NGR 177350 567300  |
| <b>Type:</b>              | Evaluation   |
| <b>Date and duration:</b> | Between 21st September and 8th October 2020                          |
| <b>Area of Site</b>       | Land Parcel 37 – 5.8ha   |

### Location of archive:

The archive from LTC15T20 (Land Parcel 37) will form part of the overall trial trenching scheme archive. This will be deposited in a repository consistent with the standards required by the Museums and Galleries Commission following completion of the archaeological phase of this project. This may either be with the local receiving museum in Thurrock or, if no such repositories are available, with a repository for the whole project designated by LTC. LTC retain the overall responsibility for the successful deposition of the project archive.

Currently, the archive is held at Oxford Archaeology's head office, Janus House, Osney Mead, Oxford, Oxfordshire, OX2 0ES. Oxford Archaeology will store the archive for LTC for a maximum period of 2 years following the completion of the project. If the storage of the archive at OA's office extends past this period, an extension to the storage period and final deposition timetable will be reviewed by OA and LTC and agreed with the major stakeholders.

### Summary of Results:

Oxford Cotswold Archaeology was commissioned by Balfour Beatty to undertake a trial trench evaluation of Land Parcels 15, 16, 17 and 37 covered by WSI J of the Lower Thames Crossing Pre-Enabling Works. Due to the limited impact anticipated in Land Parcels 15-17, it was subsequently agreed with the Key Archaeological Stakeholders that these need not be evaluated. Land Parcel 37 lies between West Tilbury and East Tilbury south-west of Station Road, within the county of Essex and Thurrock unitary authority (centred on NGR 567300 177350). A total of 42 trenches representing a 5% sample were excavated and recorded between 21st September and 8th October 2020.

The trenches revealed a dense concentration of archaeological features on the plateau running along the south-east edge of the site. The remains comprised pits and postholes demarcated by linear and curvilinear boundary ditches. The earliest activity was a middle Neolithic pit, but the main phase of occupation belongs to the late Bronze Age and/or early Iron Age. Evidence for middle Iron Age activity was equivocal, but there was further settlement in the late Iron Age and early Roman periods. The prehistoric activity included widespread evidence of salt-working in the form both of features with purplish stains, and briquetage, and the pottery of the early Roman period included regional and continental imports, suggesting that the site was both Romanised and of reasonable status.

The scale of activity contracted in the middle Roman period, and evidence for late Roman activity was limited to a single sherd of pottery. The last significant phase of activity was the early and middle Saxon period (AD 400-750), consisting of pits, postholes and several large shallow features (only partially exposed) that may be sunken-featured buildings indicating permanent settlement. Anglo-Saxon activity was more widely spread than the earlier activity on the high ground. Medieval activity was limited to a few sherds of pottery from ditches and



a pit in the north-east corner of the site, and it is unclear whether these features were medieval or later.

Some of the exposed ditches matched the alignment and were close to the line of field boundaries on historic maps, and most other ditches, including the cropmark boundaries, ran either on or at right angles to these alignments, suggesting that the site was divided into smaller land parcels in the past, originating either in the medieval or post-medieval period.

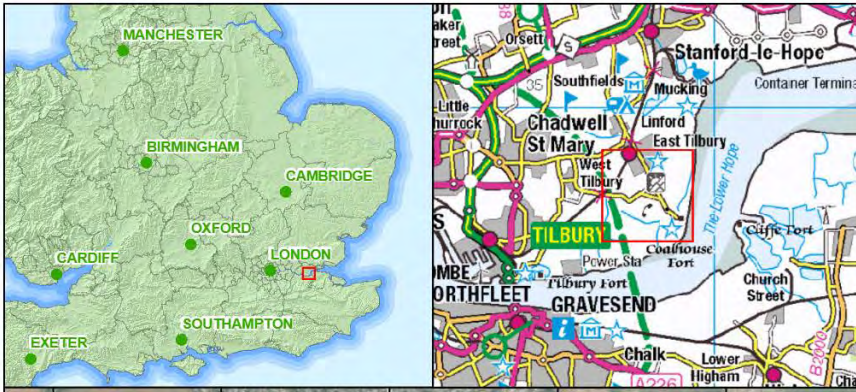

Figure 1: Location of Land Parcel 37

W:\10.010.886\Projects\MULTICEV\_Lower\_Thames\_Crossing\010\Geomatics\03\_GIS\_Projects - L1\CI\ST2017\Parcel - L1\CI\ST2017\_Fig1.mxd\caroline.soudry\25\11\2020

Contains OS data © Crown Copyright and database right 2020  
 Source: Esri, DigitalGlobe, GeoEye, Earthstar Geographics, CNES/Airbus DS, USDA



Figure 2: Plan of trench layout

\\10.10.108\Projects\MTC\CEV\_Lower\_Thames\_Crossing\010\Geomatics\03\_CIS\_Projects - LT\GIS\20\Figures\TCS15720\_Fig3.mxd;caroline\_sourday;04/12/2020

### Trench 28 - Detail

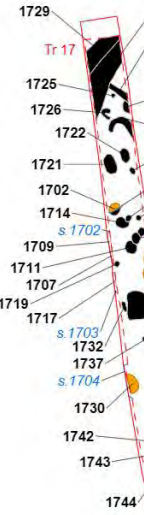
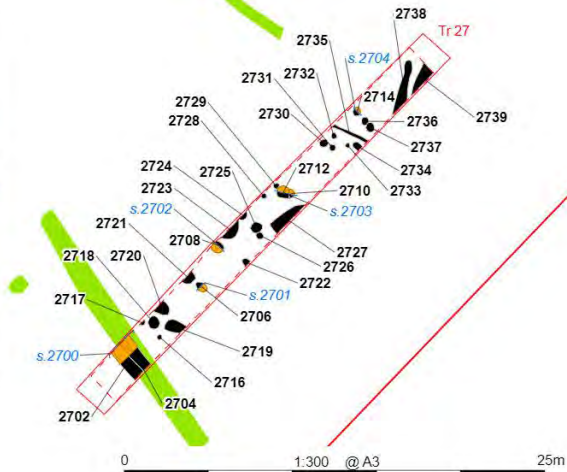
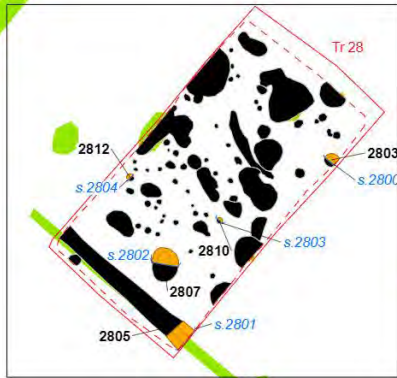
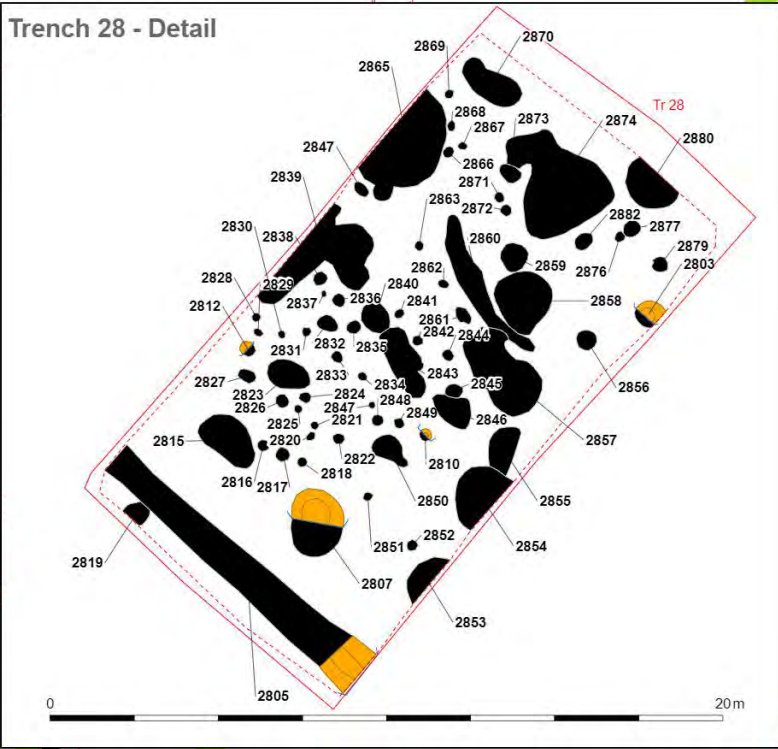

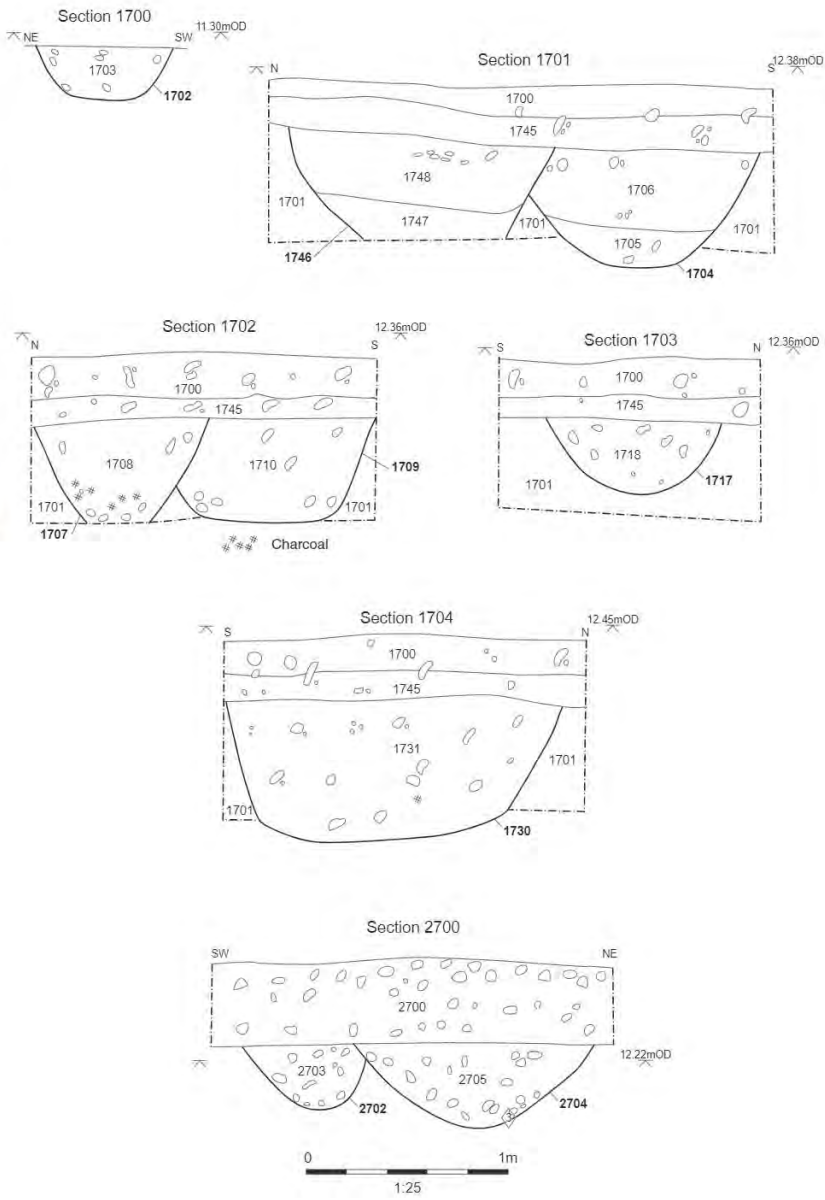

Figure 4: Sections (Trenches 17 and 27)

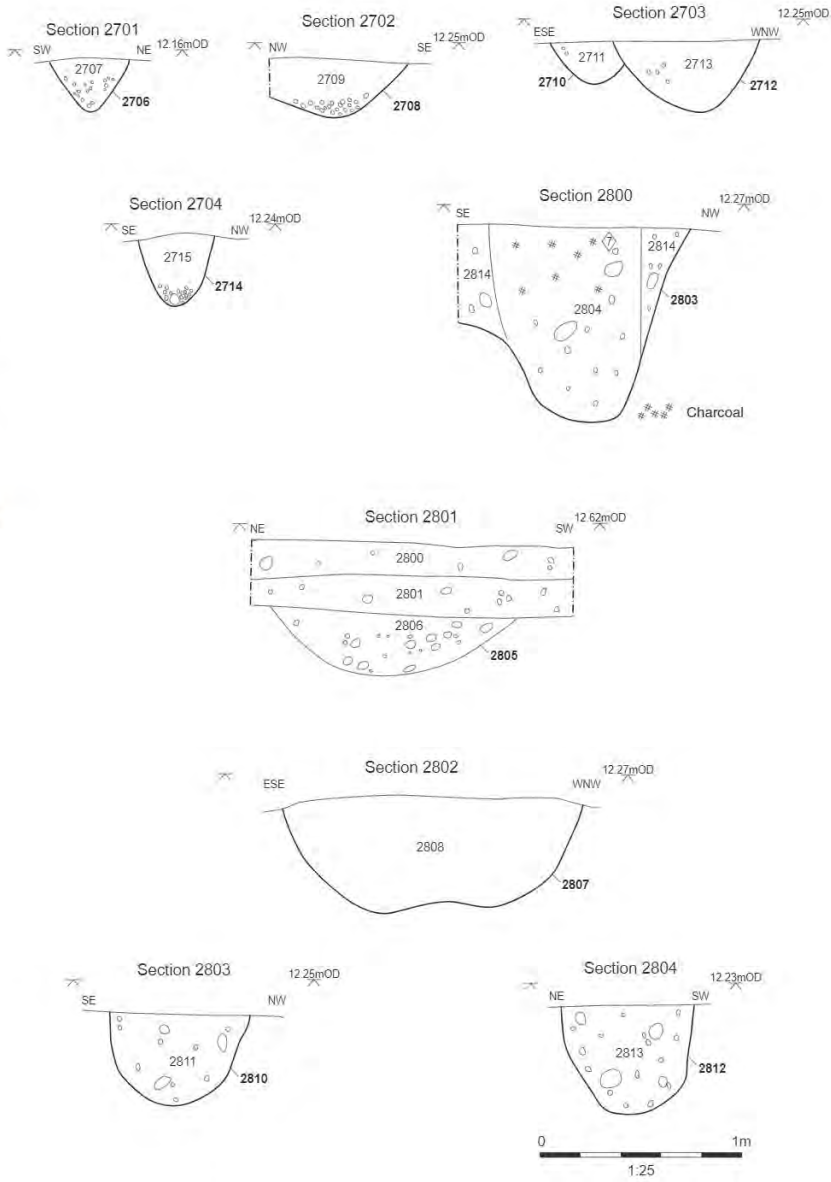

Figure 5: Sections (Trench 28)



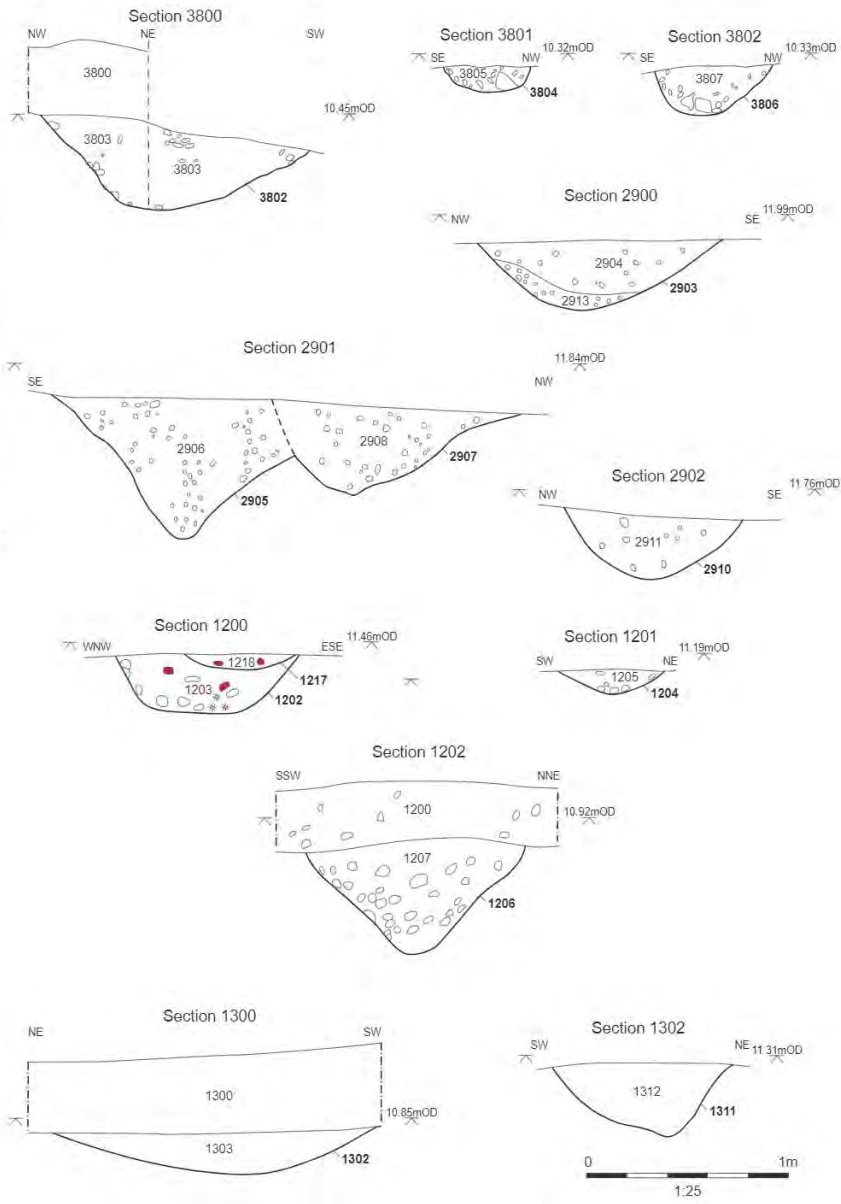

Figure 7: Sections (Trenches 38, 29, 12 and 13)



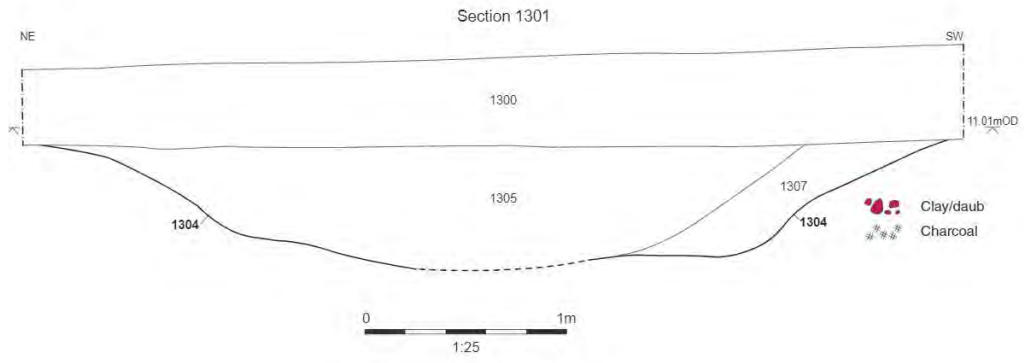

Figure 8: Section (Trench 13)

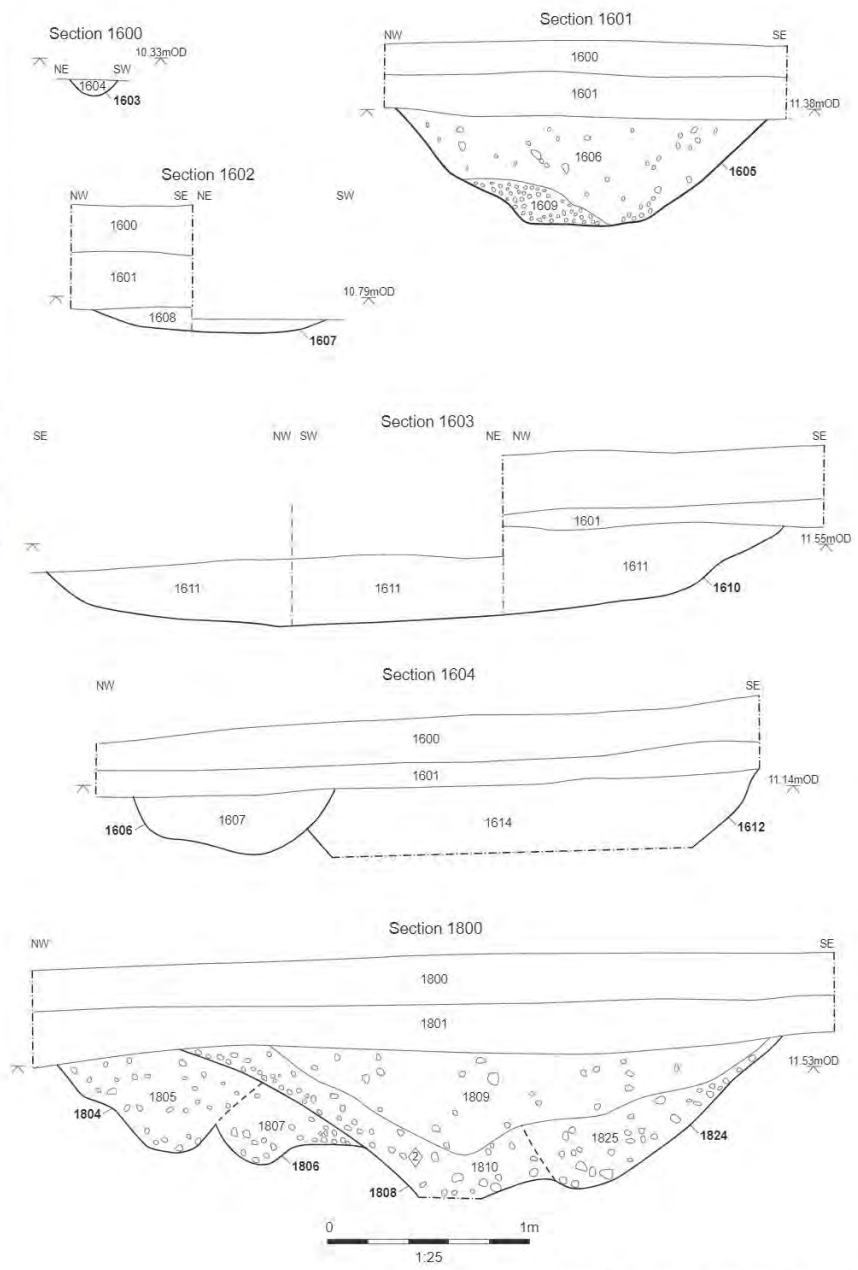

Figure 9: Sections (Trenches 16 and 18)

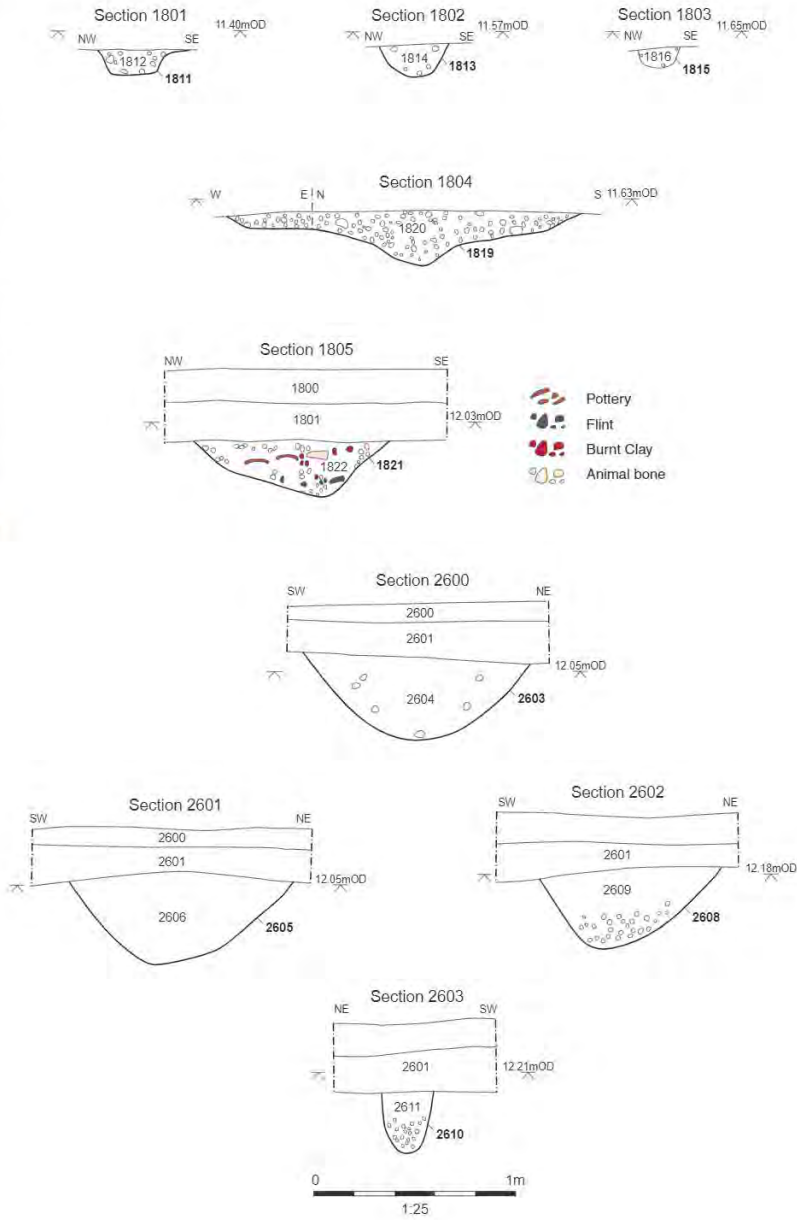

Figure 10: Sections (Trenches 18 and 26)

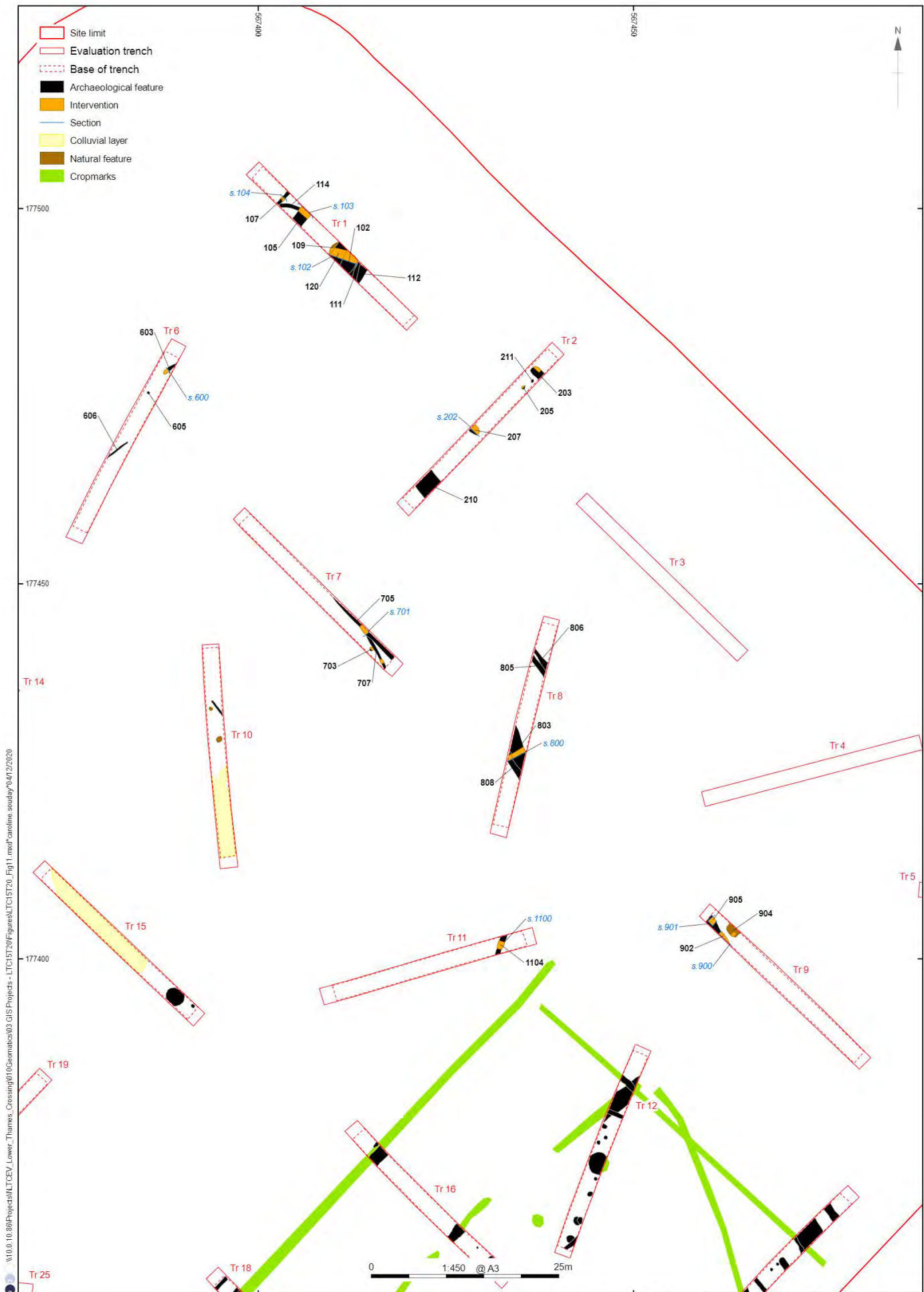

Figure 11: Detailed plan of trenches 1, 2, 6, 7, 8, 9 and 11

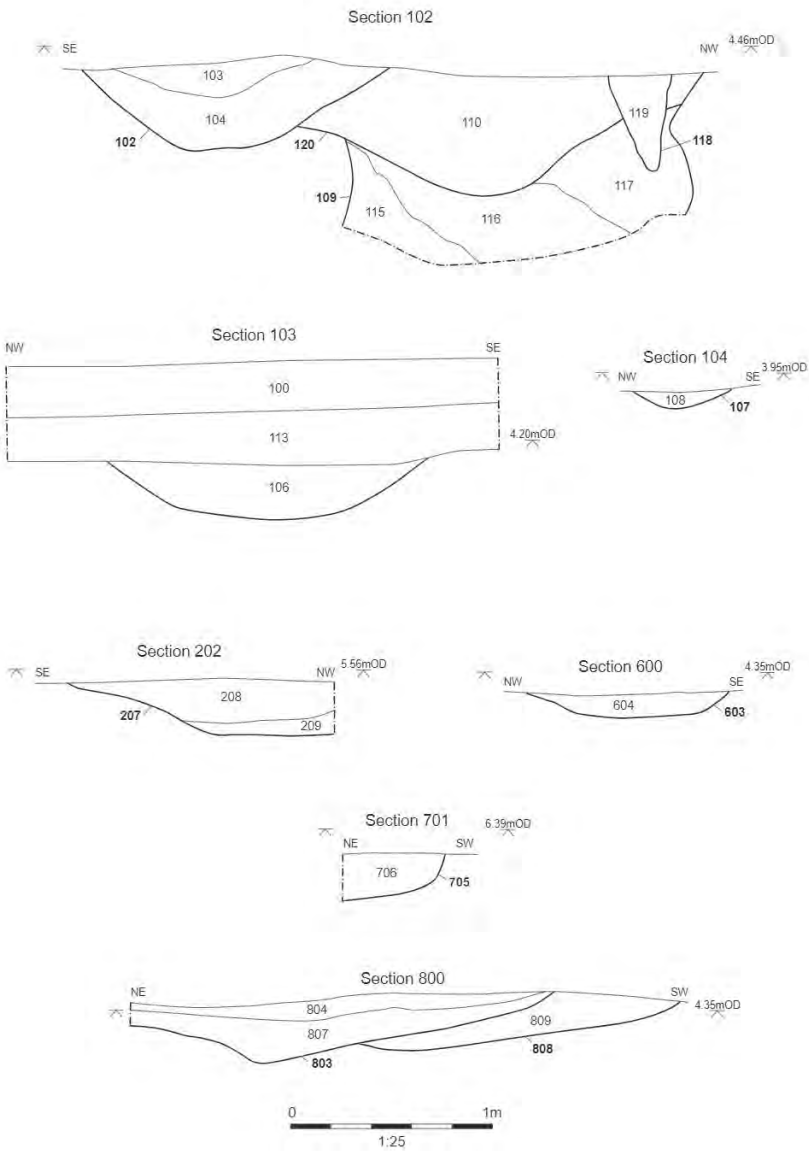

Figure 12 : Sections (Trenches 1, 2, 6, 7 and 8)



\\10.10.10.88\Projects\UCT\CEV\Lower Thames\_Crossing\010\Geomatics\03 GIS Projects - LT\GIS\20\Figures\TC151720\_Fig 4.mxd\caroline.soudry\*26/11/2020

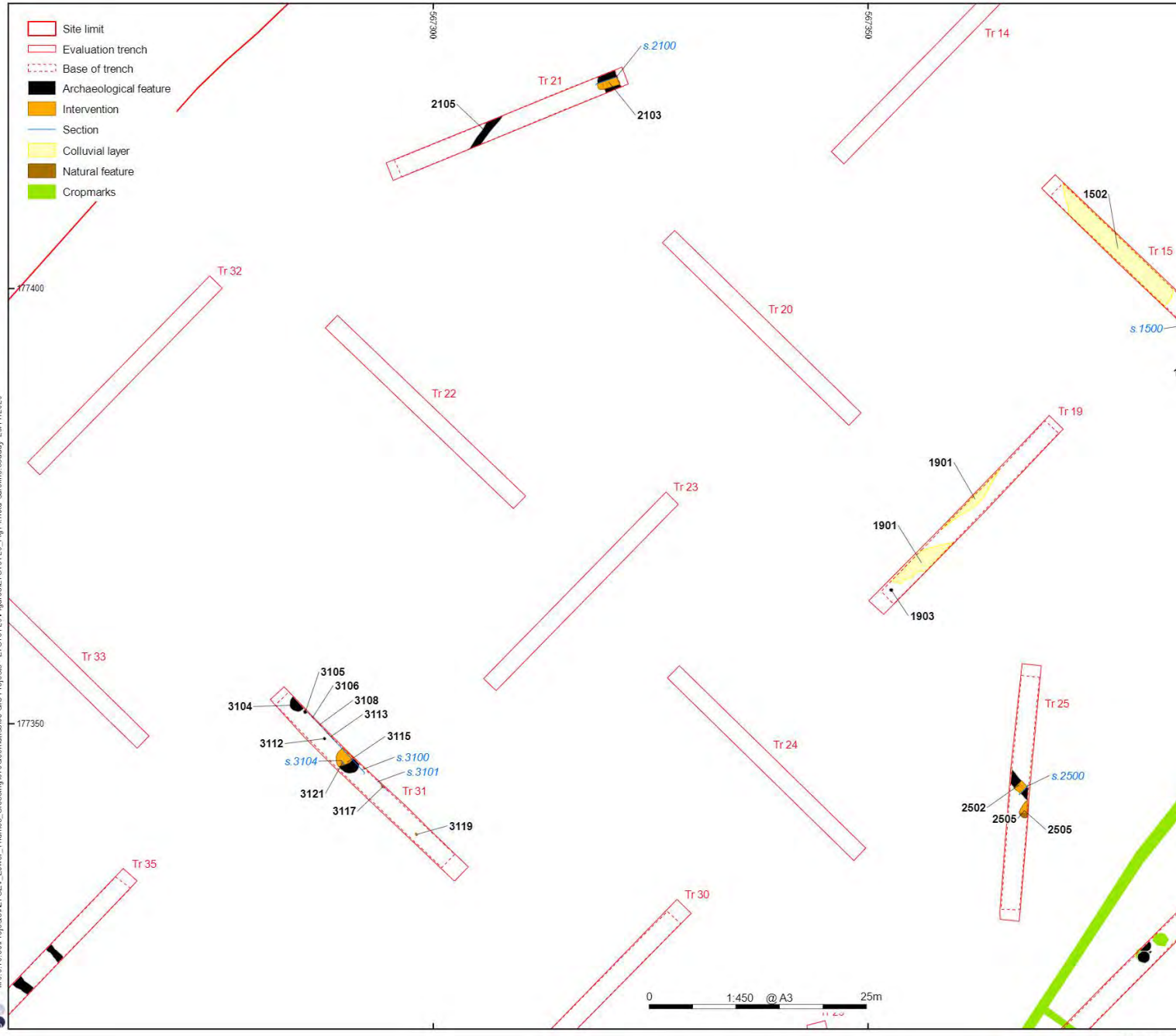

Figure 1

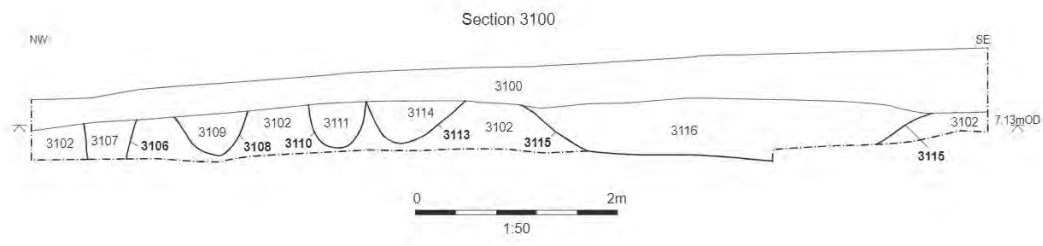
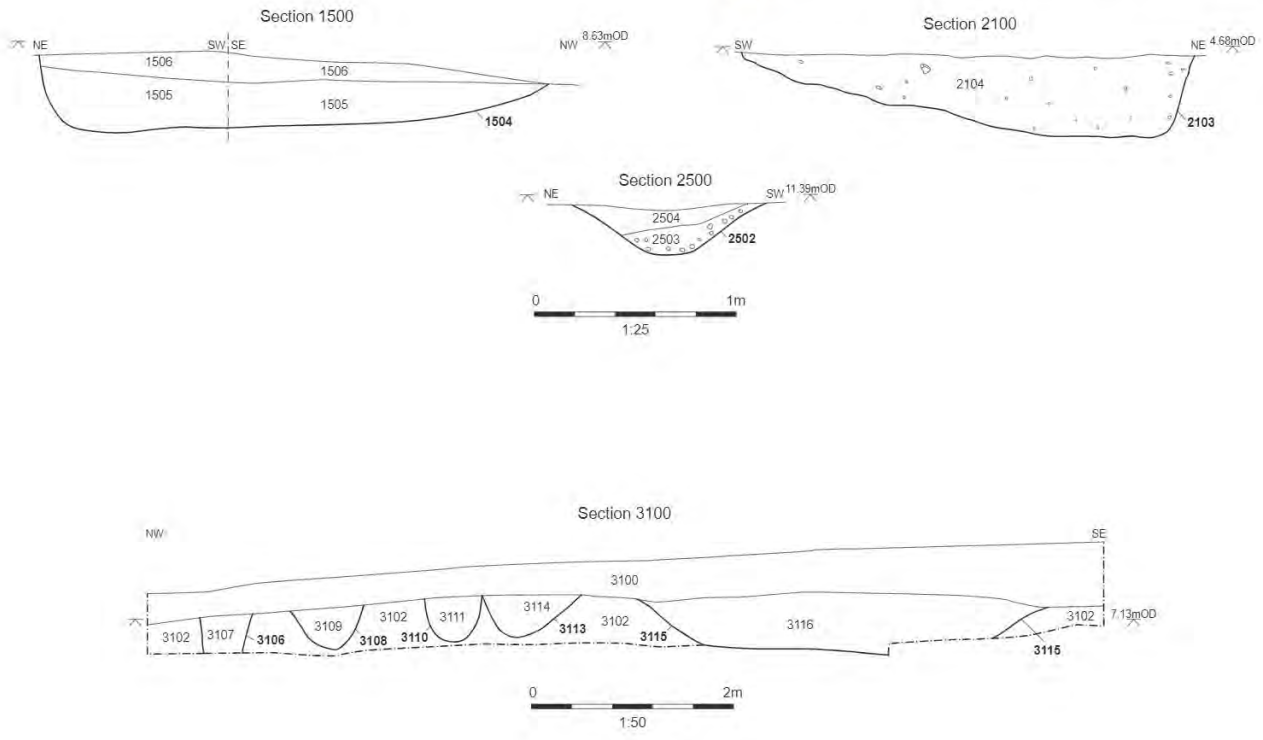

Figure 15: Sections (Trenches 15, 21, 25 and 31)



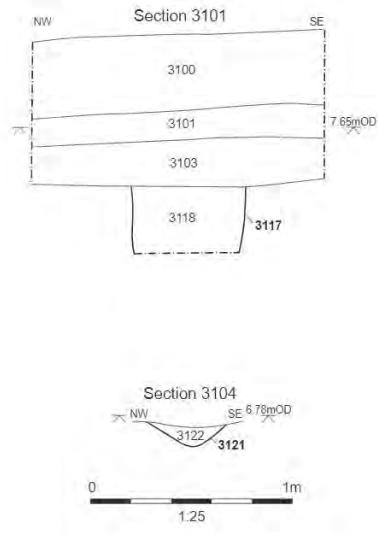
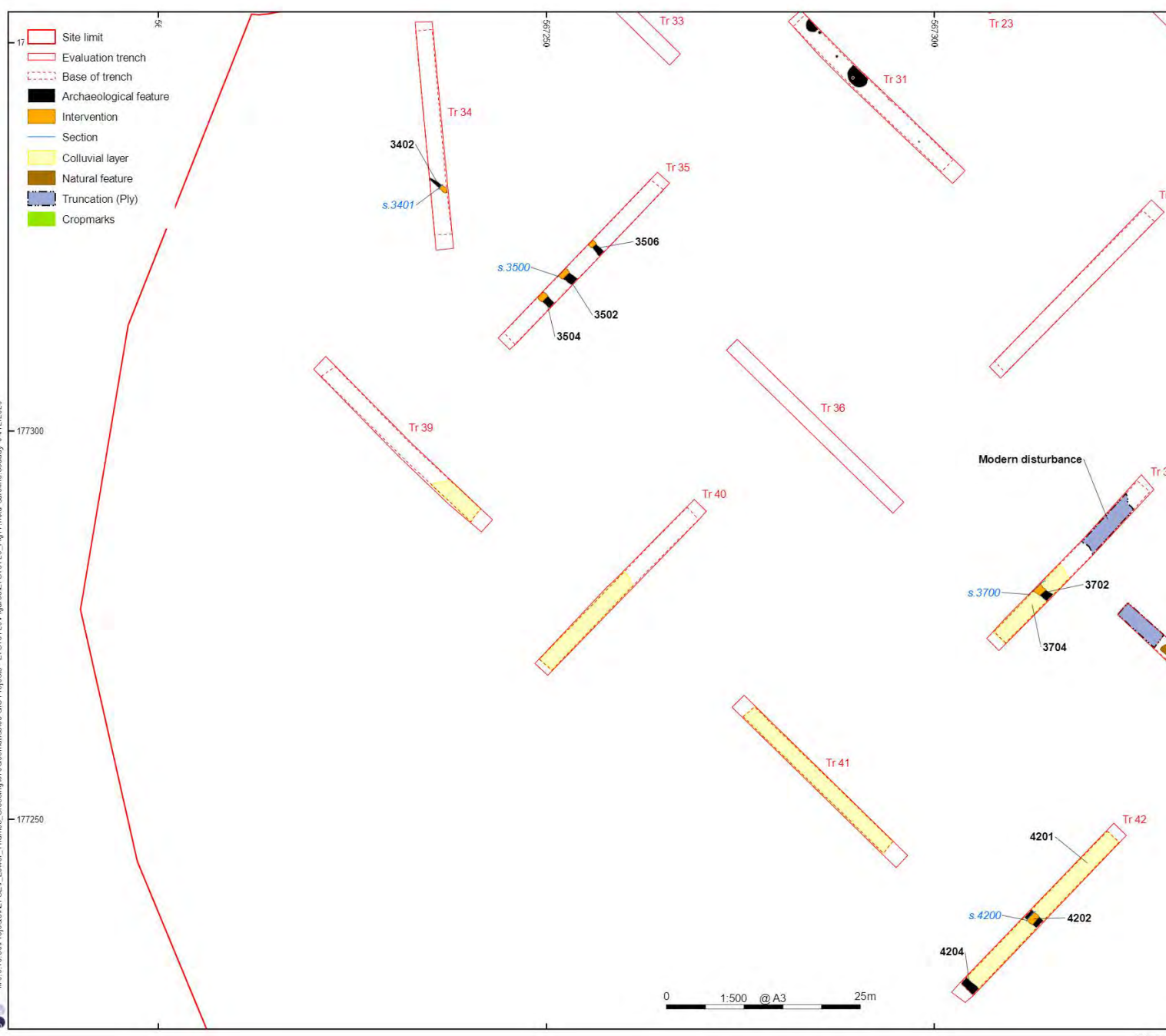

Figure 16: Sections (Trench 31)

\\10.10.108\Projects\UCT\CEV\_Lower\_Thames\_Crossing\010\Geomatics\10 GIS Projects - LT\GIS\1720\Figures\TIC151720\_Fig17.mxd\caroline.soudry\04/12/2020



Figure

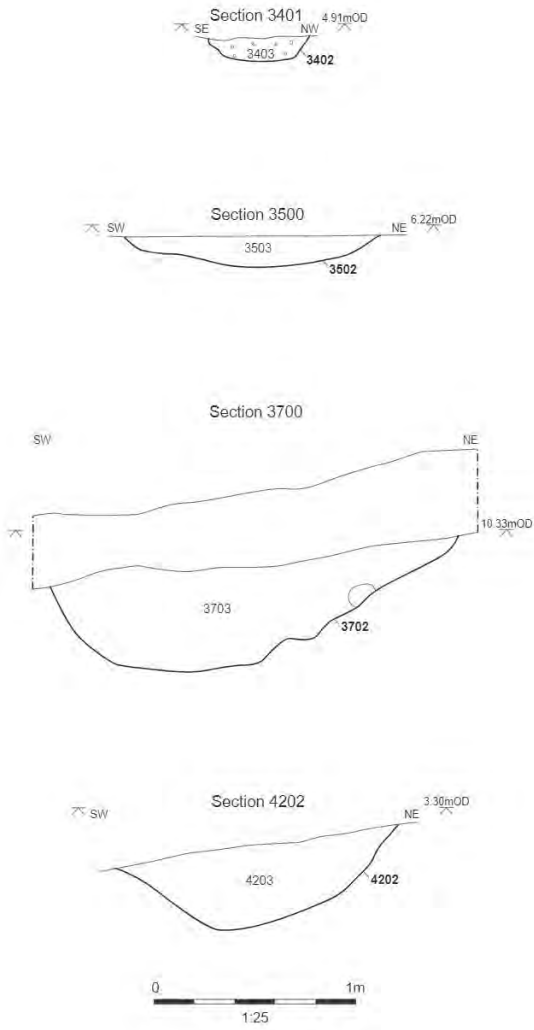

Figure 18: Sections (Trench 34, 35, 37 and 42)



Plate 1: Pit 1704 (view to south-east)



Plate 2: Pits 1707 and 1709 (view to west)



Plate 3: Pits 2710 and 2712 (view to south-west)



Plate 4: Posthole 2714 (view to south)



Plate 5: Trench 28 (view to south)



Plate 6: Working shot of Trench 28 (view to north)





Plate 9: Ditches 1804, 1806 and 1808 (view to north-east)



Plate 10: Ditch 1605 (view to north-east)





Plate 11: Unexcavated pit 1210 (view to north-east)



Plate 12: Ditches 1304 and 1306 (view to south-east)





Plate 15: Ditch 2502 (view to north-west)



**Balfour Beatty**

## COVER SHEET

|                      |   |
|----------------------|---|
| <b>Title:</b>        | <b>Archaeological Evaluation Report for Trial Trenching of Land Parcels 55, 56 and 58</b> |
| <b>Project Name:</b> | <b>Lower Thames Crossing Enabling Works</b>   |
| <b>Ref No:</b>       | <b>HE540039-BAL-GEN-GEN-REP-HER-00036</b>   |
| <b>Revision No:</b>  | <b>P01</b>  |
| <b>Review Date:</b>  | <b>15/01/2020</b>   |
| <b>Status:</b>       | <b>S2 – Information</b>   |
| <b>No. of Pages</b>  | <b>Pages 236</b>  |

| <b>Rev</b> | <b>Date of Issue</b> | <b>Revision Status</b> | <b>Originator</b> | <b>Checker</b> | <b>Approver</b> |
|------------|----------------------|------------------------|-------------------|----------------|-----------------|
| P01        | 15/01/2021           | S2 For Information     | Sam Ashton        | Jack Fletcher  | Emily Erswell   |
|            |                      |                        |                   |                |                 |
|            |                      |                        |                   |                |                 |
|            |                      |                        |                   |                |                 |



# Lower Thames Crossing

Archaeological Evaluation Report for Trial Trenching of  
Land Parcels 55, 56 and 58,  
London Borough of Havering and Brentwood, Essex

Document Number: HE540039-BAL-GEN-GEN-REP-HER-00036

**January 2021**



| <b>Revision</b> | <b>Production Date</b> | <b>Prepared by</b>  | <b>Checked by</b>  | <b>Approved for release by</b> | <b>Sections revised</b> |
|-----------------|------------------------|---|--|--------------------------------|-------------------------|
| 1.0             | Dec 2020               | Charlotte Howsam<br>Project Officer<br>Oxford Archaeology | Ed Biddulph<br>Senior Project Manager,<br>Oxford Archaeology     | Internal review only           |                         |
| 1.1             | January 2021           | Charlotte Howsam<br>Project Officer<br>Oxford Archaeology | Steve Lawrence,<br>Senior Project Manager,<br>Oxford Archaeology |                                |                         |
|                 |                        |   |  |                                |                         |
|                 |                        |   |  |                                |                         |

This Evaluation Report has been prepared for Highways England in accordance with the terms and conditions of appointment stated in the Lower Thames Crossing (LTC) Technical Partner Contract. LTC cannot accept any responsibility for any use of or reliance on the contents of this document by any third party.

# Contents

---

| Section  | Page       |
|--|------------|
| <b>Summary</b> .....   | <b>6</b>   |
| <b>Acknowledgements</b> .....                                      | <b>7</b>   |
| <b>1 Introduction</b> .....  | <b>8</b>   |
| 1.1 Project details and scope of work .....                        | 8          |
| 1.2 Location, topography and geology .....                         | 9          |
| 1.3 Previous investigations .....                                  | 9          |
| 1.4 Archaeological and historical background.....                  | 10         |
| <b>2 Project Aims</b> .....  | <b>15</b>  |
| 2.1 General aims .....   | 15         |
| 2.2 Specific objectives .....                                      | 16         |
| <b>3 Methodology</b> .....   | <b>18</b>  |
| 3.1 Constraints.....   | 18         |
| 3.2 Methodology for the evaluation .....                           | 18         |
| <b>4 Results</b> .....   | <b>20</b>  |
| 4.1 Introduction and presentation of results .....                 | 20         |
| 4.2 General soils and ground conditions.....                       | 20         |
| 4.3 General distribution of archaeological deposits .....          | 20         |
| 4.4 Trenches 7, 8 and 15 (Figs 6 and 9).....                       | 21         |
| 4.5 Trenches 10, 18 and 21-26 (Figs 7 and 9).....                  | 21         |
| 4.6 Trenches 29, 30 and 32 (Figs 8 and 9).....                     | 23         |
| 4.7 Trenches 33, 37, 39 and 41 (Figs 10 and 11) .....              | 24         |
| 4.8 Trenches 46, 47, 50-52, 55 and 120 (Figs 12 and 13).....       | 24         |
| 4.9 Trenches 54, 59, 61, 63 and 70 (Figs 14 and 16) .....          | 27         |
| 4.10 Trenches 91, 99, 131-133, 135 and 136 (Figs 15 and 16).....   | 27         |
| 4.11 Trenches 114, 115 and 118 (Figs 17 and 19) .....              | 29         |
| 4.12 Trenches 124, 126-128, 130, 138 and 140 (Figs 18 and 19)..... | 29         |
| 4.13 Trenches 157 and 165 (Figs 20 and 21).....                    | 31         |
| 4.14 Undated features (Figs 4 and 5) .....                         | 31         |
| 4.15 Finds summary .....   | 32         |
| 4.16 Environmental summary .....                                   | 32         |
| <b>5 Discussion</b> .....  | <b>33</b>  |
| 5.1 Reliability of field investigation .....                       | 33         |
| 5.2 Interpretation.....  | 33         |
| 5.3 Evaluation objectives and results.....                         | 35         |
| <b>Appendix A Trench Tables</b> .....                              | <b>37</b>  |
| <b>Appendix B Finds Reports</b> .....                              | <b>94</b>  |
| <b>Appendix C Environmental Reports</b> .....                      | <b>108</b> |
| <b>Appendix D References</b> .....                                 | <b>114</b> |
| <b>Appendix E Abbreviations and Glossary</b> .....                 | <b>117</b> |

## Figures

- Figure 1: Site location
- Figure 2: Overall trench location plan
- Figure 3: Land Parcel 55 trench location plan
- Figure 4: Land Parcel 56 trench location plan
- Figure 5: Land Parcel 58 trench location plan
- Figure 6: Detailed plan of Trenches 7, 8 and 15
- Figure 7: Detailed plan of Trenches 10, 18 and 21 to 26
- Figure 8: Detailed plan of Trenches 29, 30 and 32
- Figure 9: Sections (Trenches 8, 10, 15, 18 and 29)
- Figure 10: Detailed plan of Trenches 33, 37, 39 and 41
- Figure 11: Sections (Trenches 37 and 39)
- Figure 12: Detailed plan of Trenches 46, 47, 50 to 52, 55 and 120
- Figure 13: Sections (Trenches 46, 50, 52 and 120)
- Figure 14: Detailed plan of Trenches 54, 59, 61, 63 and 70
- Figure 15: Detailed plan of Trenches 91, 99, 131 to 133, 135 and 136
- Figure 16: Sections (Trenches 63, 91, 132 and 133)
- Figure 17: Detailed plan of Trenches 114, 115 and 118
- Figure 18: Detailed plan of Trenches 124, 126 to 128, 130, 138 and 140
- Figure 19: Sections (Trenches 115, 124 and 138)
- Figure 20: Detailed plan of Trenches 157 and 165
- Figure 21: Sections (Trenches 157 and 165)
- Figure 22: 1896 Ordnance Survey

## Plates

- Plate 1: Ditch 2103 and recut 2107, looking south
- Plate 2: Posthole 2903, looking east
- Plate 3: Pit 4702, looking south
- Plate 4: Pit 5011, looking north-west



Plate 5: Pit 13307, looking south  
Plate 6: Ditch 13507, looking NNW  
Plate 7: Ditch 12603, looking south  
Plate 8: Ditch 12703, looking SSE  
Plate 9: Pit 12804, looking south  
Plate 10: Pit 13003, looking north  
Plate 11: Feature 13804, looking south-east

## Tables

Table 1: Prehistoric pottery  
Table 2: Quantification of late Iron Age and Roman fabrics  
Table 3: Quantification by EVE of Roman pottery forms  
Table 4: Description of post-Roman pottery by context  
Table 5: Quantification of the flint assemblage  
Table 6: CBM and fired clay assemblage – Land Parcel 56  
Table 7: CBM and fired clay assemblage – Land Parcel 55  
Table 8: Description of small finds by context  
Table 9: Assessment of bulk soil samples  
Table 10: Animal bone assemblage, number of identified fragments by period  
Table 11: Shell assemblage

## Summary

---

Oxford Cotswold Archaeology was commissioned by Balfour Beatty to undertake a trial trench evaluation of Land Parcels 55, 56 and 58 covered by WSI N of the Lower Thames Crossing Pre-Enabling Works, centred on NGR 558409 188554. Land parcel 55 is located within the London borough of Havering, while Land Parcels 56 and 58 are located in Brentwood, in the county of Essex. A total of 165 trenches were excavated and recorded between 7th September and 8th October 2020.

Of the 165 trenches excavated, 52 trenches were found to contain a low density of archaeological remains comprising ditches, pits, postholes and natural features such as tree-throw holes. Slight concentrations of features were revealed in the east of the site within Land Parcel 56.

A small quantity of worked flint of Mesolithic/Neolithic date provides a limited and perhaps transitory presence in the wider landscape during the earlier prehistoric period. A small number of pits and a ditch containing middle Bronze Age to early Iron Age pottery provide further evidence of low-level prehistoric activity on site and within the surrounding landscape.

Evidence of Roman activity is limited to two pits in the east of the site, within the north of Land Parcel 56, though they contained relatively large quantities of Roman pottery. The majority of this pottery dates to the late Roman period, though residual pottery of early-middle Roman date is also represented. These remains are suggestive of activity that may have been related to Roman settlement and agricultural activity encountered immediately to the north at Hobbs Hole.

Evidence of late Saxon and medieval activity was largely concentrated in a small number of trenches located in the east of the site towards the north of Land Parcel 56. Small quantities of 10th- to 14th-century pottery were recovered from a few ditches and pits. It is probable that they were related to agricultural activity associated with nearby settlement.

Late post-medieval/modern remains were revealed across the site in the form of ditches that correspond with field boundaries depicted on historic Ordnance Survey mapping, and residual finds in topsoil deposits. These remains are demonstrative of agricultural use of the landscape during this period.

## Acknowledgements

---

Oxford Cotswold Archaeology would like to thank the client, Balfour Beatty, for commissioning this project and managing the site safety and attendances. Thanks are also extended to Historic Environment Consultants Richard Havis of Place Services at Essex County Council, who advise the Borough of Brentwood, and Adam Single of the Greater London Archaeological Advisory Service, advising the London Borough of Havering, for monitoring and providing advice throughout the project.

The project was managed for Oxford Cotswold Archaeology by Steve Lawrence. The fieldwork was directed by Mark Dodd and Anna Moosbauer, who were supported by Robert McIntosh, Jana Smirnova, Adam Moffat, Megan Lillington, Dan Firth, Eilidh Barr, Fanny Dubuc and Adrian Arenas. Site survey was undertaken by Caroline Souday and Rachel Alexander, and digitising was carried out by Caroline Souday. Thanks are also extended to the teams of OA staff that cleaned and packaged the finds under the management of Leigh Allen and Geraldine Crann, processed the environmental remains under the management of Rebecca Nicholson, and prepared the archive under the management of Nicola Scott.

# 1 Introduction

---

## 1.1 Project details and scope of work

- 1.1.1 The Lower Thames Crossing (LTC) Project is located between the A2 in Kent and the M25 in the London Borough of Havering. It will run underneath the River Thames through a tunnel and emerge on the northern side of the river at East Tilbury. From the North Portal the road will run to the M25 at Junction 29 via the A13 and pass between North and South Ockendon. The development of the project is managed by LTC, a partnership between Highways England and a consultancy joint venture set up to oversee the scheme.
- 1.1.2 A programme of archaeological trial trenching commenced in the Essex part of the scheme in November 2019. A scheme-wide specification for trial trenching was written by LTC (Highways England 2018), and in July 2019, LTC commissioned Balfour Beatty to deliver the pre-Enabling Works. Balfour Beatty appointed Oxford Archaeology (OA) to prepare a project-wide written scheme of investigation (WSI) for the scheme, which (at the request of the key archaeological stakeholders) is divided into two parts, one for the Kent section and another for Essex and Havering (Oxford Archaeology 2019a; 2019b).
- 1.1.3 Following completion of the project-wide WSIs, OA was instructed to prepare a series of site-specific or group-site specific WSIs for approval by the key archaeological stakeholders in advance of trial trenching to inform the Development Consent Order (DCO). A detailed WSI was created for Land Parcels 55, 56, 58, 59, 110, 111 and 112 prior to the trial trenching (WSI N, Oxford Archaeology 2020), which detailed the archaeological background and potential within the site. It also set out the archaeological aims and objectives appropriate to the investigation of these land parcels by trenching and described the methodology to be applied. The WSI was approved by Richard Havis, Principal Historic Environment Consultant for Place Services at Essex County Council (ECC), and Adam Single, Archaeology Advisor for Greater London Archaeological Advisory Service (GLAAS), prior to the start of the fieldwork. Oxford Cotswold Archaeology was commissioned as Balfour Beatty's archaeological contractor to undertake the evaluation in accordance with the approved WSI and local and national planning policies. At the time of fieldwork, however, only Land Parcels 55, 56 and 58 were accessible and available for archaeological evaluation.
- 1.1.4 The fieldwork in Land Parcels 55, 56 and 58 was completed between 7th September and 8th October 2020. All work followed the MoRPHE Project Manager's guide (Historic England 2015), and the Code of Conduct of the Chartered Institute for Archaeologists (CIfA 2014a). The archaeological works adhered to the standards and guidance for archaeological evaluation, excavation and archiving (CIfA 2014b; CIfA 2014c).

- 1.1.5 The work was monitored by Richard Havis of Place Services ECC on behalf of the Borough of Brentwood and by Adam Single of GLAAS on behalf of the London Borough of Havering.

## 1.2 Location, topography and geology

- 1.2.1 Land Parcels 55, 56 and 58 (hereafter referred to as 'the site') are located north and south of Junction 29 of the M25 and north of the London, Tilbury and Southend Railway line (Fig. 1). Land Parcel 55 is located on the western side of the M25 within the London Borough of Havering. Land Parcel 56 is situated on the eastern side of the M25 within the Borough of Brentwood in Essex. Land Parcel 58 is located north of Junction 29 of the M25 and the London, Tilbury and Southend Railway line.
- 1.2.2 Land Parcels 55 and 56 are located on the slopes of a plateau, falling from c 28m aOD at the north to c 8m aOD along the southern edge. Land Parcel 58 is located on a plateau of higher ground north of the Mar Dyke valley at height of 36m aOD. Several streams pass in close proximity to the site, including one that runs past the east edge of Land Parcel 58 and continues alongside the M25 south of Junction 29 before turning south-east across the south side of Land Parcel 56. This is joined by a stream running west from Great Warley Hall, which skirts the north edge of the same land parcel. These streams feed into the Mar Dyke River located c 1km south-east of the site. The valley of the River Ingrebourne lies around 2km to the west.
- 1.2.3 The British Geological Survey (BGS) records the underlying bedrock geology of the site as clay, silt and sand of the London Clay Formation (BGS 2020). The majority of the site is covered in superficial Head deposits of clay, silt, sand and gravel, though alluvial deposits of clay, silt, sand and gravel have been recorded along the line of streams crossing the southern part of Land Parcel 56 and at the very east edge of Land Parcel 58.
- 1.2.4 Land Parcels 55 and 58 were under arable cultivation at the time of fieldwork, whilst Land Parcel 56 was scrubland or rough pasture. Within the surrounding landscape, land use is a mixture of agricultural land and urban development associated with Cranham. There are also a number of industrial estates located either side of the A127 and Folkes Lane. The M25, London, Tilbury and Southend Railway and the development of Cranham and associated industrial estates have altered the rural character of this area and have displaced the historic field boundaries and road network.

## 1.3 Previous investigations

- 1.3.1 A single below-ground archaeological investigation is known to have been undertaken within the site boundary of Land Parcel 55. The Upminster Bund excavation (M25008.09) revealed a number of archaeological features, which are discussed in more detail below.
- 1.3.2 Several other archaeological investigations have been completed within the vicinity of the site as part of the M25 widening scheme between 2008 and 2011. From north to south this includes: the Warley Road to Beredens Lane Strip Widening (M25014.10), the Folkes Lane Strip Widening, the Codham Hall Bund, Tank 1762 and Strip Widening (M25018.10) adjacent to Land

Parcel 58, the Hobbs Hole evaluation and excavation (M25001.08/09) located just north of Land Parcel 56 and the Pond 1776 (M25021.11) located just south of Land Parcel 56. The Warley Road to Beredens Lane Strip Widening did not identify any finds or features, while the Folkes Lane excavation identified two modern ditches, one orientated N-S and the other NE-SW (Oxford Archaeology 2012; Biddulph and Brady 2015). The Pond 1776 excavation found only a N-S aligned field boundary of post-medieval date and a modern posthole, together with one residual struck flint. The Codham Hall Bund and the Hobbs Hole excavation both revealed archaeological features, which are discussed in below.

## 1.4 Archaeological and historical background

- 1.4.1 The chronological summary of known archaeological remains given below is taken from the detailed WSI for Land Parcels 55, 56, 58, 59, 110, 111 and 112 (Oxford Archaeology 2020) and summarises the most pertinent information relating to Land Parcels 55, 56 and 58, whilst still giving an overview of the archaeological background of the surrounding landscape.
- 1.4.2 **Palaeolithic.** No Palaeolithic finds have been recorded within the site. The nearest recorded Palaeolithic find is a handaxe that was found 0.5km west of Land Parcel 59.
- 1.4.3 **Mesolithic, Neolithic and Early Bronze Age.** No finds of Mesolithic date are known to have been found within the site or the surrounding 1km area. Towards the north end of the site (Land Parcel 58), a flint scraper of Neolithic or early Bronze Age date was found during the M25 widening north of Junction 29 at Codham Hall Bund, and several struck flints of probable late Neolithic or early Bronze Age date were recovered during excavations at Upminster Bund (Biddulph and Brady 2015, 17, 28).
- 1.4.4 **Later Bronze Age and Iron Age.** Evidence of later Bronze Age and Iron Age activity was found within Land Parcel 55 of the site, adjacent to Land Parcel 58 and also at Hobbs Hole just north of Land Parcel 56 during improvements to the M25 from Junction 29 southwards (ibid, 19-27).
- 1.4.5 A single unaccompanied cremation was found in the southern part of Land Parcel 55 during the Upminster Bund M25 excavation. The Upminster Bund cremation was radiocarbon-dated to 1270-1050 cal BC at 95% confidence (SUERC-43695; 2949 ± 29 BP). It lay alongside an interrupted NW-SE pit alignment that contained fragments of late Bronze Age or early Iron Age pottery, although this pottery may have been residual (Biddulph and Brady 2015, 25). The remains of prehistoric activity of similar date was also identified during the excavation at Hobbs Hole, which was located adjacent and north of Land Parcel 56. The earliest feature within this area comprised a late Bronze Age to early Iron Age hollow located on the upper slope of the valley and c 100m north of Land Parcel 56 (ibid, 19-27).
- 1.4.6 A series of late Iron Age to early Roman ditches enclosing an area of activity were excavated at Codham Hall Bund just outside the south end of Land Parcel 58 (ibid, 17-18).

- 1.4.7 Some 600m to the south-east, the Hobbs Hole excavation, just north of Land Parcel 56, produced a number of late Iron Age cremations that lay within an enclosure located at the top of the valley slope (ibid, 19-22).
- 1.4.8 **Roman period.** The excavation at Hobbs Hole, just north and north-east of Land Parcel 56, identified early-middle Roman rectilinear enclosures, ditches and several large quarry pits. No domestic structures were found, and the enclosures were interpreted as livestock enclosures, although a fair quantity of pottery was found. Two whole pots of early Roman date from one feature suggested a possible cremation burial and another cremation burial dated to the late 2nd century AD. This site appears to have been occupied from the late Iron Age until the late Roman period (Biddulph and Brady 2015, 19-24). Further pits, quarries and a cremation burial were found in the south-west part of the site. The Hobbs Hole site was located 1.3km north of the projected line of an E-W aligned Roman road. This site was also located on the gentle slopes to the south of a plateau and adjacent to a valley and a stream. It is likely that a domestic rural settlement existed close to this pastoral agricultural site.
- 1.4.9 A late Iron Age/early Roman site was also identified at Codham Hall Bund 800m north-west of the Hobbs Hole excavation and adjacent to Land Parcel 58. This excavation revealed a series of ditches that had silted up by the 1st century AD, although a jar dated to the 2nd-4th-century AD was also found within a pit (Biddulph and Brady 2015, 18).
- 1.4.10 Three Roman findspots have been recorded within the study area, found 100m south-west of Land Parcel 112, 0.5m west of land Parcel 59 and 1km south of the site at Hole Farm.
- 1.4.11 **Medieval period.** Early Saxon activity was identified next to the site during the M25 excavations at Codham Hall Bund and Hobbs Hole. Charcoal-rich pits were found at Codham Hall Bund, one of which was radiocarbon-dated to 410-540 cal AD (SUERC-43697; 1596 ± 29 BP). A possible sunken-featured building at Hobbs Hole containing pottery dating from the 5th-7th centuries was the only certain Saxon feature recorded from this site, but a scatter of Saxon pottery was also found in the tops of later Roman features (Biddulph and Brady 2015, 18-19, 24). Charred grain from a pit at Upminster Bund within Land Parcel 55, possibly associated with an irregular pit alignment, was radiocarbon-dated to 690-890 cal AD (SUERC-43696; 1230 ± 27 BP), that is, within the middle Saxon period. No other early Saxon finds or features are known within 1km of the site.
- 1.4.12 During the late Saxon period, the western part of the site may have been part of one of two manorial estates in the later parish of Cranham. The eastern part of the site may have been part of the one of the three manorial estates within Great and Little Warley. Cranham had 29 households in 1086 and the settlement of Great and Little Warley had 45 households at this time. Both entries in the Domesday Book mention a range of resources for both settlements, including ploughland, pasture and woodland for pigs, along with a large number of sheep and a small amount of cattle (Palmer 2019). This suggests that there was a mixture of arable and pastoral farming taking place in this area during the late 11th century.

- 1.4.13 In the later medieval period, the western part of the site (Land Parcels 59, 110, 111 and 112) became part of the parish of Cranham and the eastern and southern part of the site (Land Parcels 55, 56, 58) became part of the parish of Great Warley.
- 1.4.14 The location of one of the late Saxon manors of Great Warley may have been c 700m east of Land Parcel 56 in the vicinity of the demolished church of St Mary. Another Saxon manor may have been located in the vicinity of Warley Franks Manor, located 50m south of Land Parcel 55. This manor, located north of St Mary's Lane (now the B187) on the edge of the northern Mar Dyke valley, was a moated manor established by 1086 (Powell 1978, 163-74). The current listed manor house on the site dates from the 15th century and is associated with a moat to the south that has been significantly altered. A square earthwork was noted at this location by the aerial survey, and this is likely to relate to the medieval moat (Aerial Investigations and Mapping Report site 3). Further medieval manors and settlements have been recorded within the parish of Cranham to the north of the site in proximity of Land Parcels 59 and 111.
- 1.4.15 The HER includes a number of entries for the dispersed medieval settlement of Great Warley, and these are all linked to the same gazetteer entry. This includes the medieval settlement of Great Warley, which was located c 700m north-east of the site, along with dispersed parts of the settlement along Codham Hall Lane and Great Warley Street. The medieval manor of Codham Hall was located c 200m east of Land Parcel 58 and was demolished and rebuilt in the 19th century. The medieval manor of Great Warley Hall was located 600m north-east of Land Parcel 56, and this was close to the now demolished medieval church. This manor house was demolished in the 1730s (Powell 1978, 163-74).
- 1.4.16 Several N-S aligned roads in the vicinity of the site may have originated in the medieval period. This includes the two forks of Folkes Lane in the parish of Cranham (adjacent to Land Parcels 110, 111 and 112), the lane from Great Warley to Codham Hall and St Mary's Lane from Great Warley to North Ockendon and Upminster. These routes passed medieval manors such as Beredens Manor, Warley Franks Manor, Codham Hall and Great Warley Hall, along with the site of the medieval church of St Mary. It is possible that several or all of these routes were used by pilgrims who made their way southwards towards the River Thames and the shrine of St Thomas Becket in Canterbury. The pilgrims would have stopped at settlements and religious houses along the way (Yates 2018) and may have stopped in Brentwood at the Chapel of St Thomas a Becket before continuing on to Great Warley and then continuing southwards.
- 1.4.17 The Victoria County History (VCH; Powell 1978) notes that the medieval road that linked Great Warley to Codham Hall may have continued southwards to Warley Franks Manor and onwards to join with the E-W part of St Mary's Lane. The Ordnance Survey (OS) first edition maps of 1865-6 (not illustrated) of this area show a footpath that bisected Land Parcel 56 and may have linked Codham Hall to Warley Franks Manor (Powell 1978). The VCH also notes that the OS first edition labels this route as Pilgrims Way, but a review of the OS first edition maps did not find any evidence of



this. It is possible that pilgrims may have used this route, though it is more likely they used St Mary's Lane since it passed the medieval church of St Mary, now demolished.

- 1.4.18 The HER notes that the site of a former possible fishpond, mill and dam is located at Hobbs Hole Grove just north-west of Land Parcel 56 of the site. This possible mill site would have been situated c 700m west of the Great Warley settlement. The grove was formed by a lake created by an L-shaped dam that abutted the steeply rising side of the valley in which it sits. The grove may have been the site of a medieval mill site or a fishpond, and part of this possible fishpond was recorded just south-west of this grove in the footprint of the M25. The aerial survey found no trace of these features, but this area is covered in woodland, which may have impeded the survey (Aerial Investigations and Mapping Report site 2).
- 1.4.19 Several E-W aligned medieval ditches were recorded at Codham Hall Bund next to Land Parcel 58 during the M25 excavation of the site (Biddulph and Brady 2015, 19). Banks and ditches were also noted just south of this on the LiDAR during the aerial survey (Aerial Investigations and Mapping Report site 1). These earthworks were located c 200m south of Land Parcel 58. In addition, ridge-and-furrow earthworks have been recorded within Land Parcel 55 just north of Warley Franks Manor, and these open fields may have belonged to this manor in the medieval and post-medieval period.
- 1.4.20 **Post-medieval to modern periods.** Apart from the construction of the Tilbury and Southend Railway in 1892 and the M25, both of which bisect this part of the scheme, this area retained a largely rural character in the post-medieval to modern period, with dispersed settlements along key roads. A number of post-medieval buildings (listed and unlisted) are located in the settlement of Great Warley located c 700m north-east of the site and along the lane to Codham Hall and Great Warley Street (also known as St Mary's Lane) east of the M25 and along Folkes Lane to the west of the M25.
- 1.4.21 The Cranham tithe map dated 1841 shows that Land Parcels 59, 110, 111 and 112 within this parish had three different owners, demonstrating that the landscape contained scattered farmsteads with associated agricultural land used for arable and pastoral purposes, and as meadow fields (Powell 1978, 103-9). The majority of the field boundaries shown on the tithe map have been removed with the exception of the WNW-ESE aligned field boundary within the northern part of Land Parcel 110.
- 1.4.22 The Great Warley 1835 tithe map shows that Land Parcels 55, 56 and 56 belonged to Warley Franks Manor, which was located 50m south of Land Parcel 55. The owner at this time was Richard Brinsley Sheridan (Powell 1978, 163-74). These land parcels were used mostly as arable land, with the exception of a few pasture fields at the southern end of Land Parcel 55 and the southern end of Land Parcel 56. Most of the field boundaries that were in existence in 1835 have now been removed. The exception is one E-W aligned boundary in the southern part of Land Parcel 56, which is still extant and also defines a stream.
- 1.4.23 **Undated features and cropmarks.** There are several areas of woodland located north-east of Land Parcel 58 and south-west of Land Parcel 55. These areas of woodland are of unknown date, but it is possible that they

are relicts of much larger areas of woodland that covered this area in the Saxon period and which may have been cleared in the later medieval period. If these areas of woodland are of some antiquity, they may contain evidence of previously un-surveyed features.

- 1.4.24 Apart from the cropmarks mentioned above to the south of Land Parcels 55 and 58 (Aerial Investigations and Mapping Report sites 1 and 3), there were no other undated cropmarks noted in the area of the site or the vicinity. This may be partly due to the patches of woodland (as mentioned above), which may have restricted the areas that could be surveyed with LiDAR and aerial photography.

## 2 Project Aims

---

### 2.1 General aims

- 2.1.1 The general aims of the project, as stated in the detailed WSI (Oxford Archaeology 2020), were as follows:
- i. To establish the presence or absence of archaeological remains along the line of the scheme and the extent of any areas where remains appear likely to be absent;
  - ii. In areas where archaeological remains are known or suspected, to clarify the reliability of the cropmark or geophysical survey evidence;
  - iii. In areas where no archaeological remains are indicated by aerial or geophysical survey, to clarify whether this apparent absence of remains is genuine;
  - iv. To determine the degree of complexity of any surviving horizontal or vertical stratigraphy and, in particular, to investigate areas where topography indicates the likelihood of deep deposit sequences for evidence of buried archaeological horizons and palaeoenvironmental sequences;
  - v. Where remains are present, to determine the period(s) represented, the extent, state of preservation and character of the archaeological remains;
  - vi. To establish the range and state of preservation of archaeological artefacts and, through their recovery and examination, to establish the potential for information about the economy, status and contacts of past inhabitants of the scheme footprint;
  - vii. To determine whether palaeoenvironmental remains are preserved and, where these are found, to determine their types (eg. charred plant remains, waterlogged remains, molluscan remains), state of preservation and potential for environmental information. This will be achieved through the recovery of samples from sedimentary sequences and archaeological features suitable for assessment of a range of palaeoenvironmental remains (eg. charred and waterlogged plant remains, charcoal, insects, pollen, diatoms, ostracods/foraminifera and molluscs) and scientific dating (eg. radiocarbon and OSL dating);
  - viii. To investigate and record the extent, character and chronology of the sedimentary sequences, in particular those immediately adjacent to and in floodplains, contained within palaeochannels or in dry valleys, and to use the data to refine existing geoarchaeological (predictive) deposit models;
  - ix. To place any identified archaeological remains into their local and, where appropriate, regional or national context and to assess the implications of any such discoveries for our current understanding of settlement and landscape change in the area, including an assessment of the associations of any remains with reference to the historic landscape;
  - x. To provide sufficient information to enable the LTC archaeological advisor, in consultation with the Key Archaeological Stakeholders, to determine the significance of the archaeological assets identified within the land parcel;

- xi. To provide a report upon the discoveries to inform the Environmental Statement (ES) supporting the Development Consent Order (DCO) and support the preparation of a further archaeological mitigation strategy for the Enabling Works and Construction phases of the scheme; and
- xii. Following the DCO, to deposit the report in the public domain and to generate an accessible and useable archive, which will allow future research of the evidence to be undertaken.

## 2.2 Specific objectives

2.2.1 The specific project objectives, identified within the detailed WSI (Oxford Archaeology 2020), were as follows:

- xiii. To conduct the programme of archaeological investigation within the general research parameters and objectives defined by the revised East of England Research Framework (Medlycott 2011), and to take account of the aims and objectives of the Greater Thames Estuary Historic Environment Research Framework (Essex County Council, Historic Environment Branch 2010);
- xiv. To clarify whether remains of earlier prehistoric date (late Upper Palaeolithic, Mesolithic, Neolithic, Bronze Age or Iron Age) exist buried by colluvium or alluvium on the slopes of the Mar Dyke valley or in other valleys within the site, either in situ or eroded from upslope, and, if so, to establish their extent, character and date, whether through artefactual or scientific dating;
- xv. To clarify the potential for well-preserved deposits in these protected locations, whether structural, buried land surfaces with associated activity or environmental deposits and, if so, to establish their date;
- xvi. To clarify whether features of Neolithic or early Bronze Age date accompany the few finds of these periods so far discovered within the site, and if so, to establish their character, extent and duration;
- xvii. To clarify whether further activity of the later Bronze Age and Iron Age took place within the site and, in particular, whether further cremations of later Bronze Age date are present and, if so, whether these are isolated or are associated with settlement or other contemporary activity;
- xviii. To clarify the character and extent of late Bronze Age-early Iron Age activity within the area of the site, and establish whether settlement features are also present;
- xix. To establish the extent and character of Roman activity within the site and, in particular, whether the Roman activity identified at Hobbs Hole and at Codham Hall Bund extends into the site;
- xx. To establish whether further evidence of early, middle or late Saxon activity exists within the site and, if so, establish its character, date and duration;
- xxi. To establish whether the activity at Codham Hall Bund extended into the area of the site and, if so, to further define the extent and character of this activity;

- xxii. To look for evidence associated with the medieval manors and other structures known from documentary evidence adjacent to the site and, if found, to characterise and date them;
- xxiii. To look for evidence of medieval routes crossing the area of WSI N, and for evidence of a possible pilgrims' way suggested to cross Land Parcel 56, such as pilgrims' tokens;
- xxiv. To date the earthworks, ridge-and-furrow, and other field boundaries identified within the land parcels making up this site and, in particular, whether they are medieval or post-medieval; and
- xxv. To look for evidence of further medieval buildings and other structures along the roads of possible medieval origin within the site and also for direct evidence that might confirm the medieval origin of these roads.

## 3 Methodology

---

### 3.1 Constraints

- 3.1.1 Only Land Parcels 55, 56 and 58 were accessible and available for archaeological investigation at the time of fieldwork. Further evaluation may be undertaken within Land Parcels 59, 110, 111 and 112 at a future date yet to be determined.
- 3.1.2 Several constraints limited the area of land parcels available for trial trenching. A high level, high voltage overhead cable crossed the east of the site within Land Parcel 56 on a NNW-SSE alignment, and another crossed the north-west of the site within Land Parcel 55 from west to east. A number of buried services, including water, electricity, gas and telecommunications, also crossed Land Parcels 56 and 58, and the north of Land Parcel 55. No ecological constraints were identified within the site boundary, though a modern pond was noted within the already mitigated area immediately south of Land Parcel 56.
- 3.1.3 These limitations were considered when designing the detailed trench layout of the site, with suitable exclusion zones applied for the overhead and buried services. The plotted positions of buried services, however, are often only approximate, and due to this and to low-hanging overhead cables, it was necessary to adjust the locations of approximately 26 trenches in the field. In addition, a number of trenches were relocated to avoid the site compound, a hedge and trackway. The locations of the final trench locations are shown in Figure 2.

### 3.2 Methodology for the evaluation

- 3.2.1 The combined land parcel area available for archaeological evaluation was c 34.7ha, and the area available for investigation excluding areas of services, hedgerows and other constraints was c 28.8ha. A total of 165 trenches were excavated, with the vast majority of these measuring 30m long x 2m wide, though a small number of trenches were shortened to avoid on-site constraints. Of these Trenches 35 and 162 were reduced to 20m, Trench 24 to 25m, Trench 112 to 26m, Trench 2 to 27m and Trench 110 to 29m. The south-west ends of Trenches 10 and 18 were also widened to 5m in order to further investigate the continuation of the ditches revealed within the trenches. Combined, these represent a c 3.4% sample of the area available for trenching. Trenches 1 and 137 were not accessible during this phase of fieldwork. The location of the trenches is shown on Figures 2-5.
- 3.2.2 No cropmark features had been identified by the aerial investigation and mapping report of the site (Place Services 2019) and so the trench layout was devised to provide an even coverage of the land parcels, taking into account possible continuations of features identified by previous excavation and the on-site constraints.
- 3.2.3 All trenches were located using a Global Positioning System (GPS) prior to machine excavation. All trenches were excavated using a tracked

excavator fitted with a toothless bucket under constant archaeological supervision.

- 3.2.4 Revealed features were hand cleaned and sampled by hand excavation. They were recorded as outlined within the approved WSI (Oxford Archaeology 2020). All finds were bagged by context throughout the evaluation and were recovered for further investigation, and soil samples were collected as appropriate.
- 3.2.5 The site was split between the London Borough of Havering and the district of Brentwood within the county of Essex resulting in a requirement to record the site using differing identification codes. Trenches 1-32 located within Land Parcel 55 were within Havering and recorded under the site code HUP20. Trenches 33-167 (Land Parcels 56 and 58) were located within the district of Brentwood and were recorded under the site code LTC56W20.

## 4 Results

---

### 4.1 Introduction and presentation of results

- 4.1.1 The results of the evaluation are presented below and include a stratigraphic description of the trenches that contained archaeological remains. The full details of all trenches with dimensions and depths of all deposits can be found in Appendix A. Trenches entirely devoid of archaeological remains are not discussed in any further detail. Finds and environmental data are presented in Appendices B and C.
- 4.1.2 Context numbers reflect the trench numbers, unless otherwise stated. The first numerals of a context number repeat the trench number whilst allowing for a maximum range of 100 individual records for any one trench. For example, ditch 1004 is a cut within Trench 10, while pit 13105 is a cut within Trench 131. Also Trench 10 has a potential record number range of 1000-1099, while Trench 131 has a range of 13100-13199.
- 4.1.3 An overview of the results for the site is shown on Figures 2-5. Further detailed plans of the trenches that contained archaeological features are shown on Figures 6-8, 10, 12, 14, 15, 17, 18 and 20, and selected sections are shown on Figures 9, 11, 13, 16, 19 and 21.

### 4.2 General soils and ground conditions

- 4.2.1 The soil sequence encountered within the trenches was fairly uniform. The natural geology of light to dark yellowish/reddish to greyish brown silty clay was overlain by a mid to dark brownish grey clay silt topsoil/ploughsoil, c 0.20-0.46m thick. A mid orangish/greyish brown silty clay subsoil, c 0.05-0.32m thick, was identified underlying the ploughsoil and overlying the natural in approximately a quarter of trenches distributed across the site.
- 4.2.2 Areas of modern made ground of mixed deposits were recorded in Trenches 2, 3, 5, 6, 10, 23 and 26, all located in the west of the site within Land Parcel 55.
- 4.2.3 Ground conditions throughout the evaluation were generally good. Archaeological features, where present, were relatively easy to identify against the underlying natural geology.

### 4.3 General distribution of archaeological deposits

- 4.3.1 Archaeological features were located in Trenches 7, 8, 10, 15, 18, 21-26, 29, 30, 32, 33, 37, 39, 41, 46, 47, 50-52, 54, 55, 59, 60, 61, 63, 70, 91, 99, 114, 115, 118, 120, 124, 126-128, 130-133, 135, 136, 138, 140, 143, 144, 157 and 165.
- 4.3.2 The evaluation confirmed the presence of a low density and low complexity of features, with slight concentrations in east of the site within Land parcel 56. These features comprised ditches, pits, postholes and natural features, such as tree-throw holes.



## 4.4 Trenches 7, 8 and 15 (Figs 6 and 9)

- 4.4.1 Trenches 7, 8 and 15 were positioned in the south-west of the site within Land Parcel 55. A small number of archaeological features were revealed within these trenches, comprising a pit, a possible tree-throw hole and a probable palaeochannel.
- 4.4.2 **Trench 7** was located immediately to the west of Trench 8 and to the north of Trench 11. Revealed within the south of the trench, possible tree-throw hole 702 was sub-oval in plan and irregular in form, measuring 0.80m wide and only 0.04m deep. No finds were collected from the feature.
- 4.4.3 **Trench 8** was situated immediately to the east of Trench 7 and west of Trench 9. A single pit (802) was revealed in the eastern end of the trench. Measuring 0.53m wide and 0.14m deep (Fig. 9, Section 800), the pit was sub-oval in plan and contained a single fill (803) from which no finds were recovered.
- 4.4.4 **Trench 15**, located to the south and south-west of Trenches 7 and 8, contained the remains of a probable palaeochannel (1503). Underlying subsoil 1501, feature 1503 was seen to extend across the trench for c 17.7m on a roughly NE-SW alignment; its continuation was not observed in nearby trenches. It was excavated to a depth of 0.65m, though the base of the feature was not revealed given that its excavation exceeded safety regulations (Fig. 9, Section 1500). No finds were recovered from its single fill (1504).

## 4.5 Trenches 10, 18 and 21-26 (Figs 7 and 9)

- 4.5.1 These trenches were located in the south-west of the site within Land Parcel 55. A NNW-SSE aligned ditch that had been recut was recorded across Trenches 10, 18, 21, 22 and 25. The position of the ditch corresponds with a field boundary depicted on late 19th-century OS mapping. Natural features were also investigated in Trenches 23 and 26, and a possible plough scar in Trench 24.
- 4.5.2 **Trench 10** was situated immediately to the east of Trench 9 and north of Trench 14. A potential natural feature was investigated within the centre of the trench and, upon investigation, this proved to be a deeper area of subsoil 1002. A c 4.6m-wide area of a modern made-ground deposit (1001) was also revealed in the east end of the trench and appears to have formed part of the soil bund created to the north-east as part of the M25 widening works. Similar deposits were observed in the south-east end of Trench 23 situated to the south-east.
- 4.5.3 Ditch 1004 crossed the west end of the trench on a NNW-SSE alignment and continued beyond the trench limits. It measured 1.47m wide and 0.50m deep, and had moderately steep sides and a concave base (Fig. 9, Section 1000). Three fills (1005, 1006, 1010) were recorded, with fills 1005 and 1006 being of compositions typical of the site, and fill 1010 being rich in charcoal. Fill 1010 contained a piece of fired clay and two shards of modern glass. Bulk soil sample 1, collected from this fill, yielded a piece of burnt unworked flint, a large quantity of charcoal and a small amount of charred plant remains, comprising an indeterminate grain and weed seeds.

- 4.5.4 Ditch 1004 had been recut (1007) on its western side. Ditch recut 1007 was slightly narrower and shallower, measuring 1.16m wide and 0.34m deep (Fig. 9, Section 1000). Its single fill (1008) contained a piece of early to middle 19th-century ceramic building material (CBM).
- 4.5.5 **Trench 18** was located to the south of Trenches 10 and 14 and north of Trenches 21 and 23. Crossing the west end of the trench was NNW-SSE-aligned ditch 1805, which formed a continuation of the field boundary ditch seen in Trenches 10, 21, 22 and 25. Measuring 1.3m wide and in excess of 0.5m deep, the base of the ditch was not reached given the depth of the trench and safety regulations (Fig. 9, Section 1800). It contained three fills suggestive of natural erosion/slumping of the ditch sides (1807, 1808) and secondary infilling (1806). A post-medieval/modern iron nail/staple was recovered from fill 1806 alongside five pieces of post-medieval tile.
- 4.5.6 A possible ditch terminal (1803) on a similar NNW-SSE alignment cut into ditch 1805 (Fig. 9, Section 1800). It was only 0.42m wide and 0.25m deep, and contained a single fill (1804) from which a residual piece of possible Roman ceramic building material (CBM) was recovered.
- 4.5.7 **Trench 21** was positioned to the south of Trench 18 and to the west of Trench 23. Ditch 2103 crossed the trench on a NNW-SSE alignment and formed a continuation of the late post-medieval field boundary ditch depicted on historic mapping and excavated in Trenches 10 and 18 to the north and in Trenches 22 and 25 to the south. Ditch 2103 measured 1.84m wide and 0.7m deep, and had a similar profile to ditch 1004 recorded to the north (Plate 1). It contained a sequence of three fills (2104-2106), indicative of natural slumping and infilling, none of which produced any finds.
- 4.5.8 A similarly aligned later ditch (2107) recut the western half of ditch 2103. It was slightly smaller in size, measuring 1.15m wide and 0.40m deep, but had a similar profile (Plate 1). No finds were recovered from its two fills.
- 4.5.9 **Trench 23** was located to the east of Trench 21 and contained a probable tree-throw hole (2303), which was an irregular crescent shape in plan, c 0.45m wide and 0.08m deep. It contained a sterile fill similar to the overlying ploughsoil (2300). A modern made-ground deposit (2302), similar to that seen in Trench 10 to the north, extended for c 9.15m across the south-east end of the trench.
- 4.5.10 **Trench 22** was located to the south of Trench 21 and to the north of Trench 25. Ditch 2204 crossed the west of the trench on a NNW-SSE alignment and measured 1.2m wide. The ditch was not excavated, as it formed a clear continuation of the late post-medieval field boundary ditch excavated in Trenches 10, 18, 21 and 25, corresponding with historic mapping.
- 4.5.11 A shallow tree-throw hole (2203) was recorded in the east of Trench 22. Measuring 1.4m wide and 0.2m deep, it was irregular in plan shape and contained a sterile fill similar to the overlying ploughsoil (2200) and subsoil (2201).
- 4.5.12 **Trench 24** was situated to the west of Trench 22 and contained a shallow ditch (2403) on a NNW-SSE alignment and may have been the remains of a plough scar. It extended into the north end of the trench for c 1m before

ending in a rounded terminal. It measured 0.20m wide and 0.06m deep, and contained a single fill (2404) from which no finds were retrieved.

- 4.5.13 **Trench 25** was positioned to the east of Trench 24 and south of Trench 22. It contained a single ditch (2502), which formed part of the same late post-medieval field boundary ditch recorded in Trenches 10, 18, 21 and 22 to the north. In contrast to its northward continuation, ditch 2502 was 0.95m wide and 0.37m, and had not been recut. Its single fill (2503) was devoid of finds.
- 4.5.14 **Trench 26** was located to the east of Trenches 22 and 25. A possible tree-throw hole or naturally infilled hollow/depression (2603) was partially exposed towards the centre of the trench and contained a sterile fill similar to the overlying ploughsoil (2600). A firm, dark greyish brown silty clay containing modern concrete and brick fragments (2601), possibly a modern made-ground deposit, was also revealed in the south-east of the trench for a maximum of c 5.5m.

## 4.6 Trenches 29, 30 and 32 (Figs 8 and 9)

- 4.6.1 Trenches 29, 30 and 32 were positioned in the south-west of the site within the south of Land Parcel 55 and revealed a small number of archaeological features, comprising ditches and natural features.
- 4.6.2 **Trench 29** was located to the south-east of Trench 26 and north of Trench 30. In the west end of the trench there was sub-circular posthole 2903. Measuring 0.16m wide and 0.08m deep, it had a V-shaped profile (Fig. 9, Section 2900; Plate 2) and contained a single fill (2904) from which five tiny fragments of undiagnostic, undated pottery were recovered.
- 4.6.3 Approximately 7.2m to the east was a potential tree-throw hole (2905), which was 0.5m wide and 0.15m deep and contained a fill similar to the overlying subsoil (2901).
- 4.6.4 Crossing the centre of the trench was NNW-SSE aligned ditch 2906. It was 1.8m wide but only 0.16m deep and contained a single fill from which no finds were recovered. It is possible that continued into Trench 30 where it was recorded in plan only.
- 4.6.5 **Trench 30** was positioned to the south of Trench 29 and contained a NNE-SSW aligned ditch (3004). Although unexcavated, it was 1.53m wide and may have formed a continuation of the ditch recorded in Trench 29 to the north. No finds were retrieved from the surface of the feature.
- 4.6.6 A large tree-throw hole (3003) located in the south-east of the trench measured c 3m by 2.2m and continued beyond the trench limits. Where excavated, it was 0.2m deep and contained a sterile fill similar to the overburden deposits.
- 4.6.7 **Trench 32** was situated to the east of Trenches 30 and 31. A possible ditch (3205) crossed the east end of the trench on a NNW-SSE alignment. The ditch was not excavated, though it was at least 0.8m wide, continuing beyond the trench limits. No finds were recovered from the surface of the ditch. Its possible northward continuation did not appear to have been

identified during the previous excavation of Land Parcel 55 (Upminster Bund excavation, **169**; Biddulph and Brady 2015).

- 4.6.8 Three small natural features (3202-3204), interpreted to be potential tree-throw holes, were also revealed in the west of the trench. Measuring 0.49-0.79m wide and 0.04-0.09m deep, they contained similar sterile fills.

## **4.7 Trenches 33, 37, 39 and 41 (Figs 10 and 11)**

- 4.7.1 These trenches were positioned in the east of the site, within the north of Land Parcel 56, and revealed a small number of archaeological features
- 4.7.2 **Trench 33** was located to the north of Trench 37 and contained a possible tree-throw hole (3302) that measured 0.6m wide. No finds were recovered.
- 4.7.3 **Trench 37** was situated to the south of Trench 33. A large feature (3702) was investigated in the centre of the trench. It was initially recorded as a pit, though it was unclear in plan and upon further investigation appeared to have continued to the south-east, perhaps having formed a ditch terminal. Measuring 1.72m wide and 0.90m deep, its base was not reached as the depth of the feature exceeded safety regulations. It contained a sequence of at least four fills (Fig. 11, Section 3700). Upper and middle fills 3704 and 3705 both contained small quantities of fired clay, oyster shell and animal bone (including deer antler with butchery marks), together with large quantities of Roman pottery dating to AD 270-300 and residual sherds of earlier Roman pottery (442 sherds in total). Three sherds of broadly Roman pottery and two fragments of oyster shell were also recovered from lower fill 3703 and a possible iron nail shaft (SF 1) from fill 3705. Uppermost fill 3706 was devoid of finds. Bulk soil samples 1 and 2 were collected from fills 3705 and 3704, respectively, and produced further fragments of Roman pottery, burnt animal bone and fired clay, as well as moderate quantities of charcoal and a single charred indeterminate glume base fragment.
- 4.7.4 **Trench 39** was located to the south-west of Trench 37 and revealed a narrow E-W aligned ditch (3902) that entered the east of the trench and continued for c 20m, ending in a rounded western terminal. Measuring 0.7m wide and 0.16m deep (Fig. 11, Section 3900), it contained a single fill (3903) from which 31 sherds of Roman pottery dating to AD 250-400 were retrieved.
- 4.7.5 **Trench 41** was situated to the south of Trench 39. A small natural feature (4102) measuring 0.51m wide, possibly a tree-throw hole, was investigated in the centre of the trench. No finds were recovered.

## **4.8 Trenches 46, 47, 50-52, 55 and 120 (Figs 12 and 13)**

- 4.8.1 These trenches were positioned in the east of the site within Land Parcel 56, revealing a slight concentration of archaeological features, comprising ditches, pits and natural features.
- 4.8.2 **Trench 46** was located c 86m south of Trench 41. It contained a single ditch (4602), which crossed the trench on an ENE-WSW alignment and continued beyond the trench limits. Its continuation, however, was not revealed in nearby trenches. Measuring 1.62m wide and 0.54m deep, it contained a sequence of four fills (4603-4606) (Fig. 13, Section 4600).

Medieval pottery dating to c 900-1050 and animal bones were recovered from basal fill 4603 and upper fill 4606. Fill 4603 also contained an oyster shell fragment.

- 4.8.3 **Trench 47** was immediately east of Trench 47 and contained five pits (4702, 4704, 4706, 4708, 4710). Sub-circular to sub-rectangular in plan, the pits generally measured 0.44-0.70m wide and 0.07-0.12m deep, though pit 4708 was notably larger at 1.16m wide and 0.53m deep. Shallow pits 4702, 4704, 4706 and 4710 had similar profiles comprising moderately steep sides and flat bases (Plate 3). In contrast, large pit 4708 had moderately steep sides and a concave base. All contained similar single fills. Only pits 4702 and 4708 contained finds, comprising one to two sherds of medieval pottery dating to c 1000-1225 and c 900-1050, respectively. Pit 4708 also contained fragments of fired clay and a residual piece of probable Roman CBM.
- 4.8.4 **Trench 50** was located immediately to the south of Trench 47 and west of Trench 51. In the north of the trench was irregular tree-throw hole 5014, 1.42m wide, from which four fragments of fired clay, eight pieces of animal bone and two oyster shell fragments were retrieved.
- 4.8.5 To the south of this was unexcavated E-W aligned possible ditch terminal 5015, which had a slightly pointed terminal, 0.5m wide. It continued beyond the east trench limit, though its continuation was not seen in Trench 52 to the east. No finds were recovered from the surface of the feature.
- 4.8.6 Ditch 5006 crossed the centre of the trench on a ENE-WSW alignment. Continuing beyond the trench limits, its eastern continuation was recorded in Trench 52. Ditch 5006 was 0.38m wide and 0.12m deep, with sloping sides and a concave base. A sherd of medieval pottery dating to c 1000-1225 was recovered from its single fill (5007), though this is considered to have been residual, as the position of the ditch broadly corresponds with a field boundary depicted on late 19th-century OS mapping.
- 4.8.7 Ditch 5006 appears to have cut NE-SW aligned ditch 5004, which continued beyond the trench limits to the south-west, though it was not seen to have continued beyond ditch 5006 nor was its continuation identified in Trench 47 to the north. Measuring 0.84m wide and 0.24m deep (Fig. 13, Section 5001), its single fill (5005) contained residual medieval pottery (dating to c 1000-1225), animal bones, oyster shell, late 18th-/19th-century pottery and post-medieval CBM.
- 4.8.8 Sub-circular pit 5002 was adjacent to ditch 5004 and measured 0.68m wide and 0.13m deep. A sherd of medieval pottery dating to c 1000-1225, a fragment of animal bone and a residual piece of probable Roman CBM were retrieved from its single fill (5003).
- 4.8.9 Partially exposed in the south of the trench was unexcavated possible pit 5016. It was approximately 1.34m wide, though its edges were diffuse, suggesting its potential natural origin.
- 4.8.10 Two inter-cutting pits (5008 and 5011) were excavated in the south the trench, though their stratigraphic relationship was unclear during excavation. Large pit 5011 measured 1.57m wide and 0.38m deep, and had moderately sloping sides and a concave base (Plate 4). Smaller pit 5008

was 0.65m wide and 0.19m deep, but had a similar profile (Fig. 13, Section 5003). Both pits contained two fills. Upper fill 5010 of pit 5008 contained a single sherd of late Iron Age/early Roman (50 BC-AD 70) pottery. Medieval pottery dating to c 1200-1350/1400, animal bones, fired clay and burnt unworked flint were recovered from both fills (5012 and 5013) of pit 5011. Upper fill 5013 also contained two iron nails of possible post-medieval date and a residual prehistoric flint flake.

- 4.8.11 A probable tree-throw hole (5017), measuring 1.49m wide, was partially exposed in the south of the trench. No finds were recovered from the surface of the feature.
- 4.8.12 A fragment of animal bone (cattle) with butchery marks was also recovered from ploughsoil 5000.
- 4.8.13 **Trench 51** was positioned to the east of Trench 50. Ditch 5102 crossed the west of the trench on a N-S alignment. Measuring 0.9m wide and 0.26m deep, it contained a single fill (5103) from which a piece of prehistoric irregular flint waste and a fragment of animal bone were recovered.
- 4.8.14 Two possible features (5104 and 5105) were also investigated in Trench 51. Excavation revealed these to be natural in origin, possibly tree-throw holes.
- 4.8.15 Three residual sherds of medieval pottery (c AD 1000-1225?), five pieces of animal bone and a piece of post-medieval CBM were recovered from topsoil 5100.
- 4.8.16 **Trench 52** was laid to the east of Trench 51 and contained a single ditch (5202) on an ENE-WSW alignment, which formed the eastward continuation of the late post-medieval field boundary ditch recorded in Trench 50, broadly corresponding with historic mapping. Ditch 5202 was 0.30m wide, 0.11m deep and contained a single fill (5203) from which post-medieval CBM was collected (Fig. 13, Section 5200).
- 4.8.17 **Trench 55** was located immediately south of Trench 51. Ditch 5502 crossed the centre of the trench for c 7.9m on a NNW-SSE alignment, extending beyond the trench limits. Measuring 0.56m wide and 0.14m deep, its single fill (5503) contained animal bone (including partially articulated dog bones) and oyster shell.
- 4.8.18 **Trench 120** was situated c 47m to the west-south-west of Trench 55. Crossing the north-east end of the trench was ditch 12002. It continued beyond the trench limits, though it was not seen to have continued into nearby trenches. Aligned NNW-SSE, it was 1.60m wide, 0.66m deep and contained two fills (Fig. 13, Section 12000). Both fills contained animal bones and medieval pottery, with earlier material dating to c 1000-1225 recovered from lower fill 12003 and sherds dating to c 1200-1400 recovered from upper fill 12004. Two sherds of residual late Iron Age/early Roman pottery, a residual prehistoric flint flake and oyster shells were also retrieved from the upper fill, and two pieces of undated CBM were collected from the lower fill.
- 4.8.19 A piece of prehistoric irregular flint waste was residual within ploughsoil 12000.

## 4.9 Trenches 54, 59, 61, 63 and 70 (Figs 14 and 16)

- 4.9.1 These trenches were located in the east of the site within Land Parcel 56. A small number of archaeological were revealed within the trenches, including a ditch that roughly, though not directly, correlates with a field boundary depicted on late 19th-century OS mapping.
- 4.9.2 **Trench 54** was situated c 80m to the east of Trench 52 and immediately north-west of Trench 59. Possible ditch 5402 crossed the south-east end of the trench on a roughly N-S alignment. Its position closely, but not directly, corresponds with a historic field boundary. Measuring 0.7m wide and 0.2m deep, ditch 5402 contained a single fill (5403) from which two sherds of residual prehistoric pottery of possible early/middle Iron Age date was retrieved. A possible continuation of the ditch may have been recorded in Trench 63 to the south-east.
- 4.9.3 **Trench 59** was immediately south-east of Trench 54 and contained a single possible feature (5902) that, upon investigation, proved to be of natural origin, possibly constituting a tree-throw hole, c 0.80m wide and 0.08m deep. No finds were recovered from its fill.
- 4.9.4 **Trench 63** was located directly to the south of Trench 59. Aligned NNW-SSE, ditch 6302 was 1.02m wide and 0.28m deep (Fig. 19, Section 6300). Its single fill (6303) contained pieces of animal bone, modern tarmac and iron sheet fragments. It shared a similar alignment to a field boundary depicted on historic OS mapping, though its plotted position did not correlate with that of the field boundary. Nevertheless, it is probable that the ditch comprised the remains of a former late post-medieval field boundary and may have formed the continuation of the ditch recorded in Trench 54 to the north-west.
- 4.9.5 **Trench 61** was located to the west of Trench 63, immediately west of blank Trench 62. A linear feature (6102) in the east end of the trench was investigated and found to be of natural origin, possibly constituting a geological variation in the natural deposit.
- 4.9.6 **Trench 70** was positioned to the south-east of Trench 61 and revealed a possible feature (7002) that was found to be of natural origin, possibly comprising a variation in the natural geology or a tree-throw hole.

## 4.10 Trenches 91, 99, 131-133, 135 and 136 (Figs 15 and 16)

- 4.10.1 These trenches were situated in the east of the site, within the south of Land Parcel 56, and revealed a number of archaeological features, including ditches, pits and natural features.
- 4.10.2 **Trench 91** was located c 90m south of Trench 70, west of blank Trench 92. Sub-circular pit 9103 was largely exposed within the north of the trench, slightly continuing beyond the western trench limit. Measuring 1.35m wide and 0.22m deep, it contained two fills from which no finds were recovered (Fig. 16, Section 9100).
- 4.10.3 Two natural features (9106 and 9107) were also recorded in the north of the trench. Suggestive of tree-throw holes/root disturbance, they were 0.28-

0.31m wide and 0.16-0.20m deep. No finds were retrieved from the features.

- 4.10.4 **Trench 99** was positioned to the south-west of Trench 91, immediately south of blank Trench 92. Possible ditch 9903 crossed the north of the trench on a roughly E-W alignment, continuing beyond the trench limits. Its continuation was not identified within nearby trenches. Measuring at least 2.2m wide, the ditch was cut by two modern land drains, obscuring the true extent of the feature. It was excavated to a depth of 0.27m, though its base was not reached as further excavation exceeded safety regulations. No finds were recovered from its single fill (9904).
- 4.10.5 Two natural features (9905 and 9906), suggestive of tree-throw holes/root disturbance, were revealed c 11.3m to the south. Of similar form, they measured 0.5m wide and 0.12-0.16m deep. No finds were recovered from either of the features.
- 4.10.6 **Trench 131** was c 91m west of Trench 91 and contained possible pit 13105. Measuring 0.95m wide and up to 0.08m deep, its single fill was devoid of finds. Located to the south of were two natural features (13103 and 13104), which were 0.8-0.9m wide and 0.02-0.08m deep. They contained sterile fills similar to the subsoil and natural deposits. Given the similarities of these three features, it is possible that pit 13105 was also natural in origin, all perhaps representing tree-throw holes.
- 4.10.7 **Trench 132** was located to the south-east of Trench 131. Posthole 13203 was sub-circular in plan, measuring 0.24m wide and 0.10m deep (Fig. 16, Section 13200). It contained two fills: a basal fill (13204) of dark blackish brown silty clay overlain by a brownish orange silty clay (13205). Both fills were devoid of finds.
- 4.10.8 Four irregular features (13206-13209) were also recorded within the trench. Varying in size and form, they generally measured 0.2-0.5m wide and 0.10-0.25m deep, though feature 13207 was larger at 2m wide and 0.5m deep. They contained similar single fills. The nature of these features indicates their natural origin, interpreted as probable tree-throw holes and perhaps root disturbance. Three parallel modern land drains were also observed crossing the trench on a WNW-ESE alignment.
- 4.10.9 **Trench 133** was located to the south-west of Trench 132 and south of Trench 131. A possible elongated pit or ditch terminal (13303) on a NW-E alignment was exposed in the west of the trench for c 1.8m. It was 0.8m wide, 0.12m deep (Fig. 16, Section 13300) and contained a single fill (13304) from which a very small and abraded fragment of prehistoric pottery of possible early/middle Iron Age date, and pieces of burnt unworked flint and fired clay were recovered.
- 4.10.10 Two shallow pits (13305 and 13307) were also revealed within the trench. Pit 13305 was 0.90m wide and 0.18m deep, while pit 13307 was slightly larger at 1.5m wide and 0.2m deep. Both had similar profiles and single fills (Plate 5). One to two pieces of burnt unworked flint were recovered from each pit. Two fragments of burnt animal bone were also recovered from pit 13305.



- 4.10.11 **Trench 135** was laid immediately south of Trench 133. Unexcavated ditch 13503 crossed the north of the trench on an E-W alignment and continued beyond the trench limits, though it was not seen to have continued into nearby trenches. No finds were recovered from the surface of the 0.7m-wide ditch.
- 4.10.12 Ditch 13507 crossed the south of the trench for c 6m on a NNW-SSE alignment. Extending beyond the trench limits, its continuation was not seen in nearby trenches. It was 0.65m wide and 0.30m deep, with moderately steep sides and a concave base (Plate 6). No finds were recovered from its single fill.
- 4.10.13 Two possible tree-throw holes (13504 and 13506) was also recorded in the trench, measuring 0.8-1.3m wide and 0.10-0.25m deep. Both contained single sterile fills similar to the overburden deposits.
- 4.10.14 **Trench 136** was positioned to the east of Trench 135. Three tree-throw holes (13603-13605) were investigated within the trench. Measuring 0.38-0.90m wide and 0.13-0.24m deep, and irregular in form, they contained similar sterile fills. No finds were retrieved from these features.

#### 4.11 Trenches 114, 115 and 118 (Figs 17 and 19)

- 4.11.1 These trenches were positioned in the south-east of the site within Land Parcel 56 and revealed a small number of features, notably a posthole and natural features.
- 4.11.2 **Trench 114** was located c 140m south-east of Trench 99 and contained three irregular, sub-oval tree-throw holes (11402-11404), measuring 0.35-1.4m wide. Variations in the exposed natural geology were also observed in the base of the trench.
- 4.11.3 **Trench 115** was laid immediately to the east of Trench 114. Located in the centre of the trench was possible posthole 11502. Sub-circular in plan, it measured 0.28m wide and 0.08m deep (Fig. 19, Section 11500). No finds were retrieved from its single fill.
- 4.11.4 A number of natural features were also revealed in the trench. Of these, tree-throw hole 11504, measuring 2.2m wide, was investigated in the west end of the trench. No finds were recovered.
- 4.11.5 **Trench 118** was located to the east of Trench 115, adjacent to blank Trench 117. A possible tree-throw hole (11802), measuring 1.1m wide, was investigated and two modern land drains noted within the trench.

#### 4.12 Trenches 124, 126-128, 130, 138 and 140 (Figs 18 and 19)

- 4.12.1 Trenches 124, 126-128, 130, 138 and 140 were located in the east of the site within the west of Land Parcel 56. A NNW-SSE aligned ditch crossed Trenches 124, 127 and 140, approximately corresponding with a field boundary depicted on late 19th-century OS mapping. A small number of other features, including pits and postholes, were also recorded in these trenches.

- 4.12.2 **Trench 124** was located c 56m south-west of Trench 120, immediately south of blank Trench 122. Ditch 12402 crossed the centre of the trench on an NNW-SSE alignment. Its probable continuation was recorded in Trench 127 to the south-east, corresponding with historic OS mapping. Measuring 0.54m wide and 0.27m deep, it contained a single fill (12403) from which no finds were recovered (Fig. 19, Section 12400).
- 4.12.3 **Trench 126** was situated to the east of Trench 124. Located towards the centre of the site was roughly N-S aligned ditch 12603. Measuring 0.5m wide and 0.2m deep, it had moderately sloping sides and a concave base (Plate 7). Post-medieval CBM and animal bone were retrieved from its single fill (12604). A parallel modern land drain was also observed crossing the east end of the trench.
- 4.12.4 Approximately 2.86m to the east of ditch 12603 was sub-circular posthole 12605. It was 0.25m wide and 0.08m deep, and contained a single fill (12606), which was devoid of finds.
- 4.12.5 **Trench 128** was positioned immediately to the south of Trench 126. Located in the north-east end of the trench was pit 12804. Sub-oval in plan, it measured 1.60m wide and 0.22m deep (Plate 9). Two sherds of broadly 10th- to 13th-century medieval pottery and a piece of medieval/post-medieval CBM were recovered from its single fill (12805).
- 4.12.6 A NNW-SSE aligned modern land drain crossed the centre of the trench and a possible tree-throw hole (12803) was excavated c 6m to the south-west. It measured 0.38m wide and 0.13m deep and contained a sterile fill similar to the overburden deposits.
- 4.12.7 **Trench 127** was immediately laid to the west of Trench 128 and south-east of Trench 124. Ditch 12703 crossed the north of the trench on a NNW-SSE alignment for c 8.6m and formed a continuation of the late post-medieval field boundary ditch recorded in Trench 124. Measuring 0.60m wide and 0.19m deep, it had a similar profile to ditch 12402 (Plate 8). Its single fill was devoid of finds. A parallel modern field drain was noted c 1.9m to the west of ditch 12703.
- 4.12.8 **Trench 130** was located to the south-east of Trench 127, south of Trench 128. Ditch 13005 crossed the west of the trench on a N-S alignment. Measuring 0.60m wide and 0.22m deep, its single fill (13006) was devoid of finds. The ditch was not seen to have continued into nearby trenches.
- 4.12.9 Situated c 1m to the east were pits 13003 and 13009. They measured 1.30-1.45m wide and 0.17-0.18m deep and had similar profiles (Plate 10). Both contained single fills (13004 and 13010 respectively) that were similar to the underlying natural. Whilst pit 13003 was devoid of finds, 10 sherds of late Bronze Age/early Iron Age pottery were retrieved from pit 13009.
- 4.12.10 A modern feature (13011) was located to the east of pit 13009. Cut by two modern field drains, it measured 1m wide and 0.1m deep, and contained a fill in which modern finds were observed; these were not retained given their recent date.
- 4.12.11 A pit or possible ditch terminal (13007) was excavated further to the east. Continuing beyond the south trench limit, it was 1.2m wide and 0.24m deep. Its single fill (13008) contained a broadly prehistoric flint flake and two flint

blades of Mesolithic/early Neolithic date, as well as two small, abraded fragments of broadly prehistoric pottery.

4.12.12 **Trench 138** was laid to the west of Trench 130. A large feature (13804) crossed the northern half of the trench on a NE-SW alignment. Initially interpreted as a colluvial deposit, further investigation revealed it to have been a feature measuring 8.8m wide and 0.62m deep (Fig. 19, Section 13800; Plate 11). It contained a series of four fills, all of which were devoid of finds. Its plotted position is close to that of a roughly crescent-shaped pond depicted on late 19th-century OS mapping and therefore may have been related.

4.12.13 **Trench 140** was located to the south-east of Trench 138. It contained a single ditch (14002) that crossed the trench on a NNW-SSE alignment, corresponding with the position of a field boundary ditch depicted on late 19th-century OS mapping and forming a continuation of the field boundary ditch recorded in Trenches 124 and 127. Ditch 14002 was larger at 1.24m wide and 0.46 deep, and had moderately sloping, slightly stepped, sides. Its base was not reached given the depth of excavation exceeded safety regulations. Its single fill (14003) contained fragments of possibly post-medieval CBM.

### 4.13 Trenches 157 and 165 (Figs 20 and 21)

4.13.1 Trenches 157 and 165 were located in the north-east of the site within Land Parcel 58 and revealed only a small number of features.

4.13.2 **Trench 157** contained a possible pit (15702), which was irregular in plan and profile, measuring 0.70m wide and 0.12m deep (Fig. 21, Section 15700). It contained three similar mid to dark blackish grey silty clay fills (15703-15705), though fill 15704 was notable for being rich in charcoal. No finds were recovered from these fills. It is possible that this feature constituted a tree-throw hole rather than a pit.

4.13.3 **Trench 165** was located c 110m to the south-east of Trench 157, immediately south of blank Trench 164. Located towards the centre of the trench was N-S aligned ditch 16502. Although it extended beyond the trench limits, its continuation was not seen within nearby trenches. Ditch 16502 measured 0.82m wide, 0.32m deep and contained a sequence of two fills (Fig. 21, Section 16500). No finds were recovered from lower fill 16504, though it contained charcoal inclusions. Two sherds of broadly middle Bronze Age to early Iron Age pottery were recovered from upper fill 16503.

### 4.14 Undated features (Figs 4 and 5)

4.14.1 As well as those already mentioned above, further undated archaeological features were identified in the east of the site in Trench 60 (Land Parcel 56) and in Trenches 143 and 144 in the north of the site (Land Parcel 58), comprising natural features interpreted as probable tree-throw holes. They do not appear to reflect any particular patterns of activity.

## 4.15 Finds summary

- 4.15.1 **Prehistoric pottery.** Seventeen sherds of prehistoric pottery (58g) were recovered from Land Parcel 56 during the evaluation and have been broadly dated, with the Bronze Age and Iron Age represented. Five further tiny fragments of pottery (4g) were also recovered from Land Parcel 55, though they are of indeterminate date given their small size and lack of diagnostic features.
- 4.15.2 **Roman pottery.** A total of 483 sherds (7271g) of late Iron Age and Roman pottery were recovered. Most context groups date to the late Roman period, though residual earlier Roman material is also present. The material is in good condition, suggestive of relatively rapid deposition after breakage.
- 4.15.3 **Medieval and post-medieval pottery.** A total of 53 sherds (253g) of medieval and post-medieval pottery were retrieved. All but one sherd of pottery falls within a 10th- to 14th-century date bracket, with the post-medieval pottery sherd dating to the late 18th-19th century.
- 4.15.4 **Fired clay.** A small assemblage of fired clay (84 pieces, 402g) was retrieved during the evaluation, largely comprising indeterminate fragments, though pieces of possible oven/hearth furniture have been identified.
- 4.15.5 **Ceramic building materials.** A total of 33 pieces (558g) of CBM was recovered, the majority of which is of indeterminate form. However, a fragment of possible imbrex tile and brick, as well as flat tile pieces, were identified and are of probable Roman date.
- 4.15.6 **Metals.** A small assemblage of iron objects was collected, comprising a possible nail shaft (SF 1) of uncertain date, two medieval/post-medieval nails and six indeterminate sheet fragments.
- 4.15.7 **Flint.** A small assemblage of worked (eight pieces) and burnt unworked flint (25 pieces) was retrieved from the site during the evaluation, the majority of which was residual in later features and deposits. Although the burnt material is largely undiagnostic, several of the worked flints are of Mesolithic/Neolithic date.

## 4.16 Environmental summary

- 4.16.1 **Charred plant remains and charcoal.** Only a small quantity of charred plant remains was identified within the bulk soil samples collected during the evaluation, though larger amounts of charcoal were recovered. The few charred cereal remains are indeterminate, though a few weed seeds were identified.
- 4.16.2 **Animal bone.** A relatively small assemblage of animal bones, comprising 246 fragments weighing 1.2kg, was recovered during the evaluation. The majority of fragments are of unidentified mammal bones, though some taxa were identified, comprising cattle, sheep/goat, pig, deer antler, dog and horse. Some bones were partially articulated, with others showing signs of burning and butchery.

## 5 Discussion

---

### 5.1 Reliability of field investigation

- 5.1.1 The layout of trenches provided good overall coverage of the site and were located to maximise the potential for exposing archaeological remains. However, the need to avoid overhead cables and underground services resulted in small areas being omitted from the coverage.
- 5.1.2 The machining was generally carried out cleanly, providing good visibility of archaeological features and deposits against the underlying natural deposits within the evaluation trenches. Initially some deposits were sample excavated to establish if they were of geological or archaeological origin, and in some cases, putative archaeological features were shown to be no more than variations in natural deposits of silt and clay.
- 5.1.3 The evaluation demonstrated the presence of archaeological remains associated with prehistoric, Roman, medieval and post-medieval activity on site. The evaluation results are considered to have a true reflection of the archaeological potential of the site highlighted by the detailed WSI (Oxford Archaeology 2020).

### 5.2 Interpretation

- 5.2.1 **Mesolithic/Neolithic.** A small quantity of worked flint was recovered during the evaluation of the site. Although the majority of this material was found as residual finds in later features, it provides evidence of a limited and perhaps transitory presence in the wider landscape during the earlier prehistoric period. Tiny fragments of broadly prehistoric pottery were found alongside a flake and two blades of Mesolithic or Neolithic date in pit 13007 in Trench 130 and may reflect low level activity on site during this period, though it is possible this material may also have been residual, as a pit containing late Bronze Age/early Iron Age pottery was recorded within the same trench. Nevertheless, the worked flint assemblage is suggestive of earlier prehistoric activity on site or at least within the vicinity. This corresponds with the small quantity of worked flint recovered during previous archaeological investigations undertaken within the immediate landscape, including the Codham Hall Bund and Upton Bund (Biddulph and Brady 2015, 17, 28) excavations.
- 5.2.2 **Middle Bronze Age to Iron Age.** Evidence of other prehistoric activity is limited to a small number of features. Two sherds of broadly middle Bronze Age to early Iron Age pottery (though a middle Bronze Age date might be more likely) were retrieved from a ditch in Trench 165 situated in the north of the site. Together with Neolithic/Bronze Age worked flint recovered during the Codham Hall Bund excavation, this material provides limited additional evidence of low-level prehistoric activity on site and within the vicinity.
- 5.2.3 Located in the east of the site, three pits recorded across Trenches 130 and 133 each contained small quantities of pottery of either late Bronze Age/early Iron Age, possible early/middle Iron Age or broadly prehistoric

date. A number of undated pits also recorded within these trenches may have been associated with prehistoric land use. Together these features provide limited evidence of low-level activity on site during the Bronze Age and Iron Age.

- 5.2.4 **Roman.** A few sherds of late Iron Age/early Roman pottery provide some evidence of activity within the landscape during this period. Two sherds were residual within a medieval ditch in Trench 120, whilst a sherd from a pit in Trench 50 may represent that date of the pit, though this is uncertain and may also have been residual.
- 5.2.5 More substantial evidence of activity dating to the Roman period was concentrated in the east of the site, within the north of Land Parcel 56. Remains were limited to a narrow E-W aligned ditch in Trench 39 and a large pit/ditch terminal in Trench 37. These features, however, contained moderate to large quantities of late Roman pottery. Residual sherds of early-middle Roman date also recovered from these features is suggestive of earlier phases of activity on site or within the vicinity. Residual fragments of probable Roman CBM were also found in a number of later features across the site.
- 5.2.6 This evidence was found in close proximity to the remains of Roman settlement and agricultural activity previously excavated immediately to the north at Hobbs Hole (Biddulph and Brady 2015) and is likely to represent a continuation of this partly excavated site.
- 5.2.7 **Medieval.** Evidence of Late Saxon and medieval activity was largely concentrated in a small number of trenches located in the east of the site towards the north of Land Parcel 56. Small quantities of 10th- to 14th-century pottery were recovered from a few ditches and pits recorded in Trenches 46, 47, 50 and 120. Although no clear spatial patterning of these features indicates their function, it is probable that they were related to agricultural activity associated with nearby settlement in the surrounding landscape. A small number of undated pits also recorded within these trenches, and perhaps elsewhere on site, may have been related to medieval land use.
- 5.2.8 **Post-medieval.** Historic OS mapping shows that the layout and agricultural nature of the site and the wider landscape underwent few changes during the late 19th and first half of the 20th century. The site falls across a number of extant fields, though post-medieval field boundaries depicted on contemporary maps have largely been removed. The evaluation, however, revealed the remains of a number of ditches across Trenches 10, 18, 21, 22, 25, 54, 63, 124, 127 and 140, corresponding with late post-medieval field boundaries (Fig. 22). A small number of other shallow ditches on similar NNW-SSE alignments, some of which contained post-medieval CBM, were probably also related to post-medieval agricultural activities, including a probable plough scar recorded in Trench 24. A large feature excavated in Trench 138 may have been related to a pond depicted on 19th-century OS maps. Post-medieval and modern agricultural activities are also considered to have resulted in the deposition of a few residual finds within ploughsoil deposits in Trenches 50, 51, 60, 106, 114 and 120.

- 5.2.9 **Features of geological and natural origin.** The site contained a number of discrete irregular and sub-circular features suggestive of probable tree-throw holes distributed across the site. The remains of a probable palaeochannel were also recorded in the west of the site in Trench 15.
- 5.2.10 In earlier prehistory tree-throw holes were sometimes used as shelters during hunting trips or as repositories for large quantities of finds, and in later periods sometimes contain significant groups of finds, enabling a history of woodland clearance to be charted. On this site, however, only occasional finds that may have been residual have been recovered from tree-throw holes.

### 5.3 Evaluation objectives and results

- 5.3.1 The trial trench evaluation is considered to have achieved its general and site-specific aims (see above).
- 5.3.2 **Aims i–iv.** The evaluation established and recorded the presence and extent of archaeological features and deposits in 52 of the 165 trenches investigated. A low density and low complexity of features, comprising ditches, pits, postholes and natural features such as tree-throw holes, were recorded. All recorded features were found cutting into the natural deposits revealed within the bases of the evaluation trenches.
- 5.3.3 **Aims v–xi.** The evaluation revealed limited evidence of prehistoric, Roman, medieval and post-medieval activity on site. The quantity and range of finds types recovered during the evaluation were limited, indicating the probable agricultural nature of activity on site during these periods. A concentration of a large quantity of Roman pottery recovered, however, is suggestive of nearby settlement and may have been related to activity recorded to the north at Hobbs Hole (Biddulph and Brady 2015). Archaeological remains of medieval date were concentrated in the east of the site within Land Parcel 56. Although no spatial patterning was identified, these features provide some evidence of medieval activity on site, which was perhaps of an agricultural nature.
- 5.3.4 Only a very small quantity of environmental remains was recovered during the evaluation, limited to small quantities of charcoal and a single charred indeterminate glume base fragment from a Roman pit recorded in Trench 37. These remains provide little insight to the nature of past land use and economy.
- 5.3.5 A possible palaeochannel was recorded in Trench 15, though no finds or palaeoenvironmental remains were recovered from the feature.
- 5.3.6 **Aims xiii–xix.** A small quantity of earlier prehistoric worked flint of Mesolithic/Neolithic date, the majority of which was residual in later features, provides limited evidence of earlier prehistoric activity within the wider landscape. No clearly colluvial/alluvial deposits were encountered within the evaluation trenches.
- 5.3.7 Evidence of later prehistoric activity on site is limited to a few pits and a ditch that contained small quantities of middle Bronze Age to early Iron Age, late Bronze Age/early Iron Age and early/middle Iron Age pottery. These remains are suggestive of low-level prehistoric activity on site and within

the surrounding landscape. Given the paucity of Bronze Age and Iron Age remains, little can be inferred on the nature of activity on site during these periods.

- 5.3.8 **Aims xx–xxv.** No evidence of early or middle Saxon activity was revealed by the evaluation, suggesting that activity at Codham Hall Bund did not extend further eastwards into Land Parcel 58. The recovery of a small quantity of late Saxon pottery from trenches in the east of the site (Land Parcel 56), however, provides some evidence of activity on or within the vicinity of the site during this period.
- 5.3.9 Evidence of late medieval activity was limited to a small number of ditches and pits containing broadly 11th- to 14th-century pottery. No features or finds suggestive of buildings and pilgrim routeways were revealed by the evaluation. It is probable that the medieval remains encountered on site are indicative of the agricultural nature of activity within the hinterlands of nearby medieval manors.
- 5.3.10 The evaluation also identified a number of ditches that correspond with the position of field boundaries depicted on late 19th- and early 20th-century OS maps, demonstrating the continued agricultural nature of land use.



## Appendix A Trench Tables

| <b>Trench 2</b>   |       |         |           |           |   |                |       |
|---|-------|---------|-----------|-----------|---|----------------|-------|
| General description   |       |         |           |           |   | Orientation    | NE-SW |
| Trench consists of a ploughsoil overlying a modern made ground.<br>Trench devoid of archaeology.    |       |         |           |           |   | Length (m)     | 27    |
|   |       |         |           |           |   | Width (m)      | 2.2   |
|   |       |         |           |           |   | Avg. depth (m) | 1     |
| Context No.   | Type  | Fill Of | Width (m) | Depth (m) | Description   | Finds          | Date  |
| 200   | Layer |         | 2.2       | 0.3       | Ploughsoil. Mid brownish grey, sandy silt, friable                    |                |       |
| 201   | Layer |         | 2.2       |           | Other Layer. Mixed colour, mixed material, soft. Modern made ground   |                |       |
| <b>Trench 3</b>   |       |         |           |           |   |                |       |
| General description   |       |         |           |           |   | Orientation    | NW-SE |
| Trench consists of a ploughsoil overlying a modern made ground.<br>Trench devoid of archaeology.    |       |         |           |           |   | Length (m)     | 30    |
|   |       |         |           |           |   | Width (m)      | 2.2   |
|   |       |         |           |           |   | Avg. depth (m) | 1     |
| Context No.   | Type  | Fill Of | Width (m) | Depth (m) | Description   | Finds          | Date  |
| 300   | Layer |         | 2.2       | 0.34      | Ploughsoil. Mid brownish grey, sandy silt, friable                    |                |       |
| 301   | Layer |         | 2.2       |           | Other Layer. Mixed colours, mixed material, loose. Modern made ground |                |       |
| <b>Trench 4</b>   |       |         |           |           |   |                |       |
| General description   |       |         |           |           |   | Orientation    | NW-SE |
| Trench consists of a ploughsoil overlying a natural of silty clay.<br>Trench devoid of archaeology. |       |         |           |           |   | Length (m)     | 30    |
|   |       |         |           |           |   | Width (m)      | 2.2   |
|   |       |         |           |           |   | Avg. depth (m) | 0.32  |
| Context No.   | Type  | Fill Of | Width (m) | Depth (m) | Description   | Finds          | Date  |
| 400   | Layer |         | 2.2       | 0.32      | Ploughsoil. Mid brownish grey, sandy silt, friable                    |                |       |
| 401   | Layer |         | 2.2       |           | Natural. Light reddish brown, silty clay, firm                        |                |       |
| <b>Trench 5</b>   |       |         |           |           |   |                |       |
| General description   |       |         |           |           |   | Orientation    | E-W   |
| Trench consists of a ploughsoil overlying a modern made ground.<br>Trench devoid of archaeology.    |       |         |           |           |   | Length (m)     | 30    |
|   |       |         |           |           |   | Width (m)      | 2.2   |

|             |       |         |           |           |   | Avg. depth (m) | 1    |
|-------------|-------|---------|-----------|-----------|---|----------------|------|
| Context No. | Type  | Fill Of | Width (m) | Depth (m) | Description   | Finds          | Date |
| 500         | Layer |         | 2.2       | 0.35      | Ploughsoil. Mid brownish grey, sandy silt, friable                            |                |      |
| 501         | Layer |         | 2.2       |           | Other Layer. Mixed colours, mixed material, firm. Made ground for modern hill |                |      |

### Trench 6

| General description   |       |         |           |           |   | Orientation    | N-S  |
|---|-------|---------|-----------|-----------|---|----------------|------|
| Trench consists of a ploughsoil overlying a modern made ground. Trench devoid of archaeology. |       |         |           |           |   | Length (m)     | 20   |
|   |       |         |           |           |   | Width (m)      | 2.2  |
|   |       |         |           |           |   | Avg. depth (m) | 1    |
| Context No.   | Type  | Fill Of | Width (m) | Depth (m) | Description   | Finds          | Date |
| 600   | Layer |         | 2.2       | 0.4       | Ploughsoil. Mid brownish grey, sandy silt, friable                              |                |      |
| 601   | Layer |         | 2.2       |           | Other Layer. Mixed material, firm, mixed colours. Made ground from modern hill. |                |      |

### Trench 7

| General description   |       |         |           |           |   | Orientation    | N-S  |
|---|-------|---------|-----------|-----------|---|----------------|------|
| Trench consists of a ploughsoil overlying a natural of silty clay. Trench contains one natural feature. |       |         |           |           |   | Length (m)     | 30   |
|   |       |         |           |           |   | Width (m)      | 2.2  |
|   |       |         |           |           |   | Avg. depth (m) | 0.36 |
| Context No.   | Type  | Fill Of | Width (m) | Depth (m) | Description   | Finds          | Date |
| 700   | Layer |         | 2.2       | 0.38      | Ploughsoil. Dark brownish grey, sandy silt, friable                       |                |      |
| 701   | Layer |         | 2.2       |           | Natural. Light greyish brown, silty clay, firm                            |                |      |
| 702   | Cut   |         | 0.8       | 0.04      | Natural Feature. mid brownish grey, clayey silt, firm. Likely tree-throw. |                |      |

### Trench 8

| General description   |      |         |           |           |             | Orientation    | E-W  |
|---|------|---------|-----------|-----------|-------------|----------------|------|
| Trench consists of a ploughsoil overlying a natural of silty clay. Trench contains one pit. |      |         |           |           |             | Length (m)     | 30   |
|   |      |         |           |           |             | Width (m)      | 2.2  |
|   |      |         |           |           |             | Avg. depth (m) | 0.34 |
| Context No.   | Type | Fill Of | Width (m) | Depth (m) | Description | Finds          | Date |

|     |       |     |      |      |  |  |  |
|-----|-------|-----|------|------|--|--|--|
| 800 | Layer |     | 2.2  | 0.34 | Ploughsoil. Dark brownish grey, sandy silt, friable  |  |  |
| 801 | Layer |     | 2.2  |      | Natural. Light greyish brown, silty clay, firm       |  |  |
| 802 | Cut   |     | 0.53 | 0.14 | Pit  |  |  |
| 803 | Fill  | 802 | 0.53 | 0.14 | Secondary Fill. dark brownish grey, silty clay, firm |  |  |

### Trench 9

| General description  |       |         |           |           |   | Orientation    | N-S  |
|--|-------|---------|-----------|-----------|---|----------------|------|
| Trench consists of a ploughsoil overlying a subsoil and a natural of sandy gravel. Trench devoid of archaeology. |       |         |           |           |   | Length (m)     | 30   |
|  |       |         |           |           |   | Width (m)      | 2.2  |
|  |       |         |           |           |   | Avg. depth (m) | 0.4  |
| Context No.  | Type  | Fill Of | Width (m) | Depth (m) | Description   | Finds          | Date |
| 900  | Layer |         | 2.2       | 0.34      | Ploughsoil. Dark brownish grey, sandy silt, friable |                |      |
| 901  | Layer |         | 2.2       | 0.05      | Subsoil. Light greyish brown, clayey silt, firm     |                |      |
| 902  | Layer |         | 2.2       |           | Natural. Light reddish brown, sandy gravel, loose   |                |      |

### Trench 10

| General description  |       |         |           |           |   | Orientation    | E-W  |
|--|-------|---------|-----------|-----------|---|----------------|------|
| Trench consists of a ploughsoil overlying a modern made ground (at E end), overlying a subsoil and a natural of sandy gravel. Trench contains one ditch. |       |         |           |           |   | Length (m)     | 30   |
|  |       |         |           |           |   | Width (m)      | 2.2  |
|  |       |         |           |           |   | Avg. depth (m) | 0.34 |
| Context No.  | Type  | Fill Of | Width (m) | Depth (m) | Description   | Finds          | Date |
| 1000   | Layer |         | 2.2       | 0.32      | Ploughsoil. Dark brownish grey, sandy silt, friable                           |                |      |
| 1001   | Layer |         | 2.2       |           | Other Layer. Mixed colour, mixed material, firm. Made ground for modern hill. |                |      |
| 1002   | Layer |         | 2.2       | 0.12      | Subsoil. Light greyish brown, clayey silt, soft                               |                |      |
| 1003   | Layer |         | 2.2       |           | Natural. Light reddish brown, sandy gravel, loose                             |                |      |
| 1004   | Cut   |         | 1.47      | 0.5       | Ditch   |                |      |
| 1005   | Fill  | 1004    | 0.56      | 0.5       | Primary Fill. Yellowish brown gravely silt                                    |                |      |

|      |      |      |      |      |   |                   |          |
|------|------|------|------|------|---|-------------------|----------|
| 1006 | Fill | 1004 | 0.49 | 0.2  | Secondary Fill. Mid blackish grey, clayey silt, compact |                   |          |
| 1007 | Cut  |      | 1.16 | 0.34 | Ditch. Recut of earlier ditch                           |                   |          |
| 1008 | Fill | 1007 | 1.1  | 0.27 | Primary Fill. Mid greyish brown, clayey silt, loose.    | CBM               | PMed     |
| 1009 | Void |      |      |      |   | Nail, CBM         | PMed/Mod |
| 1010 | Fill | 1004 | 1.08 | 0.1  | Primary Fill. dark greyish black, clayey silt, compact. | Glass, fired clay | Mod      |

### Trench 11

|  |                |      |
|--|----------------|------|
| General description  | Orientation    | N-S  |
| Trench consists of ploughsoil and subsoil overlying a natural of sandy gravel. Trench devoid of archaeology. | Length (m)     | 30   |
|  | Width (m)      | 2    |
|  | Avg. depth (m) | 0.35 |

| Context No. | Type  | Fill Of | Width (m) | Depth (m) | Description   | Finds | Date |
|-------------|-------|---------|-----------|-----------|---|-------|------|
| 1100        | Layer |         | 2.2       | 0.29      | Ploughsoil. Mid brownish grey, clayey silt, friable |       |      |
| 1101        | Layer |         | 2.2       | 0.06      | Subsoil. Mid greyish brown, silty clay, firm.       |       |      |
| 1102        | Layer |         | 2.2       |           | Natural. Mid greyish brown, silty clay, firm.       |       |      |

### Trench 12

|  |                |     |
|--|----------------|-----|
| General description  | Orientation    | E-W |
| Trench consists of a ploughsoil and subsoil overlying a natural of sandy gravel. Trench devoid of archaeology. | Length (m)     | 30  |
|  | Width (m)      | 2   |
|  | Avg. depth (m) | 0.3 |

| Context No. | Type  | Fill Of | Width (m) | Depth (m) | Description   | Finds | Date |
|-------------|-------|---------|-----------|-----------|---|-------|------|
| 1200        | Layer |         | 2.2       | 0.31      | Ploughsoil. Mid brownish grey, sandy silt, friable. |       |      |
| 1201        | Layer |         | 2.2       | 0.05      | Subsoil. Mid greyish brown, gravelly clay, firm.    |       |      |
| 1202        | Layer |         | 2.2       |           | Natural. Mid yellowish brown, sandy gravel, loose   |       |      |

### Trench 13

|  |                |     |
|--|----------------|-----|
| General description  | Orientation    | E-W |
| Trench consists of a ploughsoil and subsoil overlying a natural of sandy gravel. Trench devoid of archaeology. | Length (m)     | 30  |
|  | Width (m)      | 2   |
|  | Avg. depth (m) | 0.3 |

| Context No. | Type  | Fill Of | Width (m) | Depth (m) | Description  | Finds | Date |
|-------------|-------|---------|-----------|-----------|--|-------|------|
| 1300        | Layer |         | 2.2       | 0.29      | Ploughsoil. Light brownish grey, clayey silt, friable. |       |      |
| 1301        | Layer |         | 2.2       | 0.05      | Subsoil. Mid greyish brown ,gravelly clay, firm        |       |      |
| 1302        | Layer |         | 2.2       |           | Natural. Mid yellowish brown, sandy gravels, friable.  |       |      |

#### Trench 14

|  |                |      |
|--|----------------|------|
| General description  | Orientation    | N-S  |
| Trench consists of a ploughsoil overlying a subsoil and a natural of sandy gravel. Trench devoid of archaeology. | Length (m)     | 30   |
|  | Width (m)      | 2.2  |
|  | Avg. depth (m) | 0.43 |

| Context No. | Type  | Fill Of | Width (m) | Depth (m) | Description   | Finds | Date |
|-------------|-------|---------|-----------|-----------|---|-------|------|
| 1400        | Layer |         | 2.2       | 0.25      | Ploughsoil. Dark brownish grey, sandy silt, friable |       |      |
| 1401        | Layer |         | 2.2       | 0.2       | Subsoil. Light yellowish brown, clayey silt, firm   |       |      |
| 1402        | Layer |         | 2.2       |           | Natural. Light reddish brown, sandy gravel, loose.  |       |      |

#### Trench 15

|   |                |      |
|---|----------------|------|
| General description   | Orientation    | N-S  |
| Trench consists of a ploughsoil and a subsoil overlying a natural of sandy gravel. Trench contains one paleochannel | Length (m)     | 30   |
|   | Width (m)      | 2    |
|   | Avg. depth (m) | 0.45 |

| Context No. | Type  | Fill Of | Width (m) | Depth (m) | Description  | Finds | Date |
|-------------|-------|---------|-----------|-----------|--|-------|------|
| 1500        | Layer |         | 2.2       | 0.38      | Ploughsoil. Mid brownish grey, sandy silt, friable.  |       |      |
| 1501        | Layer |         | 2.2       | 0.08      | Subsoil. Mid greyish brown, sandy clay, firm.        |       |      |
| 1502        | Layer |         | 2.2       |           | Natural. Mid orangish brown, clayey gravel, firm.    |       |      |
| 1503        | Cut   |         | 2         | 0.65      | Natural Feature. Paleochannel.                       |       |      |
| 1504        | Fill  | 1503    | 2         | 0.65      | Secondary Fill. Mid orangy grey, compact, silty clay |       |      |

#### Trench 16

|                     |             |     |
|---------------------|-------------|-----|
| General description | Orientation | E-W |
|                     | Length (m)  | 30  |

| Trench consists of a ploughsoil overlying a subsoil and a natural of clayey gravel. Trench devoid of archaeology.        |       |         |           |           |  | Width (m)      | 2            |
|--|-------|---------|-----------|-----------|--|----------------|--------------|
|  |       |         |           |           |  | Avg. depth (m) | 0.35         |
| Context No.  | Type  | Fill Of | Width (m) | Depth (m) | Description  | Finds          | Date         |
| 1600   | Layer |         | 2.2       | 0.32      | Ploughsoil. Mid brownish grey, sandy silt, friable.    |                |              |
| 1601   | Layer |         | 2.2       | 0.06      | Subsoil. Mid greyish brown, sandy clay, firm.          |                |              |
| 1602   | Layer |         | 2.2       |           | Natural. Mid yellowish brown, clayey gravel, firm      |                |              |
| <b>Trench 17</b>   |       |         |           |           |  |                |              |
| General description  |       |         |           |           |  | Orientation    | N-S          |
| Trench consists of a ploughsoil and subsoil overlying a natural of sandy gravel. Trench devoid of archaeology.           |       |         |           |           |  | Length (m)     | 30           |
|  |       |         |           |           |  | Width (m)      | 2            |
|  |       |         |           |           |  | Avg. depth (m) | 0.4          |
| Context No.  | Type  | Fill Of | Width (m) | Depth (m) | Description  | Finds          | Date         |
| 1700   | Layer |         | 2.2       |           | Ploughsoil. Mid brownish grey, clayey silt, firm.      |                |              |
| 1701   | Layer |         | 2.2       | 0.05      | Subsoil. Mid reddish brown, gravelly clay, firm.       |                |              |
| 1702   | Layer |         | 2.2       |           | Natural. Mid yellowish brown, sandy gravel, loose.     |                |              |
| <b>Trench 18</b>   |       |         |           |           |  |                |              |
| General description  |       |         |           |           |  | Orientation    | E-W          |
| Trench consists of a ploughsoil overlying a subsoil and a natural of silty clay with gravels. Trench contains one ditch. |       |         |           |           |  | Length (m)     | 30           |
|  |       |         |           |           |  | Width (m)      | 2            |
|  |       |         |           |           |  | Avg. depth (m) | 0.35         |
| Context No.  | Type  | Fill Of | Width (m) | Depth (m) | Description  | Finds          | Date         |
| 1800   | Layer |         | 2.2       | 0.31      | Ploughsoil. Mid brownish grey, sandy silt, friable.    |                |              |
| 1801   | Layer |         | 2.2       | 0.08      | Subsoil. Mid greyish brown, sandy clay, firm.          |                |              |
| 1802   | Layer |         | 2.2       |           | Natural. Mid yellowish brown, silty clay, firm         |                |              |
| 1803   | Cut   |         | 0.42      | 0.25      | Ditch. Ditch terminus                                  |                |              |
| 1804   | Fill  |         | 0.42      | 0.25      | Secondary Fill. Mid yellowish brown, silty clay, soft. | CBM            | Roman? (res) |
| 1805   | Cut   |         | 1.3       | 0.5       | Ditch. Excavated to 1 meter.                           |                |              |

|      |      |      |     |     |  |              |          |
|------|------|------|-----|-----|--|--------------|----------|
| 1806 | Fill | 1805 | 1.2 | 0.5 | Secondary Fill. Dark grayish black, silty clay, soft.  | CBM, Fe nail | PMed/Mod |
| 1807 | Fill | 1805 | 0.1 | 0.5 | Primary Fill. Dark yellowish brown, silty clay, soft.  |              |          |
| 1808 | Fill | 1805 | 0.1 | 0.5 | Primary Fill. Dark yellowish brown, loose, silty clay. |              |          |

#### Trench 19

| General description  |       |         |           |           | Orientation  | E-W   |      |
|--|-------|---------|-----------|-----------|--|-------|------|
| Trench consists of a ploughsoil overlying a subsoil and a natural of sandy gravel. Trench devoid of archaeology. |       |         |           |           | Length (m)   | 30    |      |
|  |       |         |           |           | Width (m)  | 2     |      |
|  |       |         |           |           | Avg. depth (m)                                     | 0.3   |      |
| Context No.  | Type  | Fill Of | Width (m) | Depth (m) | Description  | Finds | Date |
| 1900   | Layer |         | 2.2       | 0.26      | Ploughsoil. Mid brownish grey, sandy silt, soft.   |       |      |
| 1901   | Layer |         | 2.2       | 0.06      | Subsoil. Mid greyish brown, sandy clay, firm.      |       |      |
| 1902   | Layer |         | 2.2       |           | Natural. Mid yellowish brown, sandy gravel, loose. |       |      |

#### Trench 20

| General description   |       |         |           |           | Orientation  | E-W   |      |
|---|-------|---------|-----------|-----------|--|-------|------|
| Trench consists of a ploughsoil overlying a subsoil and a natural of sandy clay with frequent gravel. Trench devoid of archaeology. |       |         |           |           | Length (m)   | 30    |      |
|   |       |         |           |           | Width (m)  | 2     |      |
|   |       |         |           |           | Avg. depth (m)                                       | 0.5   |      |
| Context No.   | Type  | Fill Of | Width (m) | Depth (m) | Description  | Finds | Date |
| 2000  | Layer |         | 2.2       | 0.23      | Ploughsoil. Mid greyish brown, clayey silt, friable. |       |      |
| 2001  | Layer |         | 2.2       | 0.05      | Subsoil. Mid greyish brown, silty clay, firm.        |       |      |
| 2002  | Layer |         | 2.2       |           | Natural. Mid reddish brown, sandy clay, firm.        |       |      |

#### Trench 21

| General description   |       |         |           |           | Orientation   | E-W   |      |
|---|-------|---------|-----------|-----------|---|-------|------|
| Trench consists of a ploughsoil overlying a subsoil and a natural of sandy clay with frequent gravels. Trench contains one ditch. |       |         |           |           | Length (m)  | 30    |      |
|   |       |         |           |           | Width (m)   | 2     |      |
|   |       |         |           |           | Avg. depth (m)                                      | 0.35  |      |
| Context No.   | Type  | Fill Of | Width (m) | Depth (m) | Description   | Finds | Date |
| 2100  | Layer |         | 2.2       | 0.31      | Ploughsoil. Mid brownish grey, sandy silt, friable. |       |      |

|      |       |      |      |      |   |  |  |
|------|-------|------|------|------|---|--|--|
| 2101 | Layer |      | 2.2  | 0.06 | Subsoil. Mid greyish brown, sandy clay, firm.   |  |  |
| 2102 | Layer |      | 2.2  |      | Natural. Mid yellowish brown, sandy clay, firm.   |  |  |
| 2103 | Cut   |      | 1.84 | 0.7  | Ditch   |  |  |
| 2104 | Fill  | 2103 | 0.9  | 0.25 | Primary Fill. Dark greyish black, silty clay, moderately compact.   |  |  |
| 2105 | Fill  | 2103 | 0.52 | 0.24 | Secondary Fill. Dark greyish brown, clayey silt, moderately compact   |  |  |
| 2106 | Fill  | 2103 | 0.74 | 0.17 | Secondary Fill. Mid yellowish brown, clayey silt, moderately compact.   |  |  |
| 2107 | Cut   |      | 1.15 | 0.4  | Ditch. Recut of earlier boundary ditch.   |  |  |
| 2108 | Fill  | 2107 | 0.57 | 0.08 | Primary Fill. Mid brownish grey, silty clay, moderately compact.  |  |  |
| 2109 | Fill  | 2107 | 1.06 | 0.41 | Deliberate Backfill. Mixed light yellowish brown sandy silt and mid greyish brown silty clay, moderately compact. |  |  |

## Trench 22

| General description  |       |         |           |           | Orientation  | E-W   |      |
|--|-------|---------|-----------|-----------|--|-------|------|
| Trench consists of a ploughsoil overlying a subsoil and a natural of silty clay. Trench contains one unexcavated ditch, and one natural feature. |       |         |           |           | Length (m)   | 30    |      |
|  |       |         |           |           | Width (m)  | 2.2   |      |
|  |       |         |           |           | Avg. depth (m)   | 0.44  |      |
| Context No.  | Type  | Fill Of | Width (m) | Depth (m) | Description  | Finds | Date |
| 2200   | Layer |         | 2.2       | 0.36      | Ploughsoil. Dark brownish grey, sandy silt, friable  |       |      |
| 2201   | Layer |         | 2.2       | 0.18      | Subsoil. Mid greyish brown, silty clay, firm   |       |      |
| 2202   | Layer |         | 2.2       |           | Natural. Light greyish brown, silty clay with frequent gravel, firm.                           |       |      |
| 2203   | Cut   |         | 1.4       | 0.2       | Natural Feature. Tree-throw. Mixed dark brownish grey and mid greyish brown, sandy clay, firm. |       |      |



| 2204  | Unexcavated feature |         | 1.2       |           | Ditch. Boundary ditch excavated in TR.25. Dark brownish grey, silty clay, firm. |       |      |
|---|---------------------|---------|-----------|-----------|---|-------|------|
| <b>Trench 23</b>  |                     |         |           |           |   |       |      |
| General description   |                     |         |           |           | Orientation   | NW-SE |      |
| Trench consists of ploughsoil overlying a made ground and a natural of silty clay with frequent gravel. Trench devoid of archaeology. Trench contained one natural feature. |                     |         |           |           | Length (m)  | 30    |      |
|   |                     |         |           |           | Width (m)   | 2     |      |
|   |                     |         |           |           | Avg. depth (m)  | 0.8   |      |
| Context No.   | Type                | Fill Of | Width (m) | Depth (m) | Description   | Finds | Date |
| 2300  | Layer               |         | 2.2       | 0.32      | Ploughsoil. Mid brownish grey, sandy silt, loose.                               |       |      |
| 2301  | Layer               |         | 2.2       | 0.7       | Other Layer. Mixed colour, mixed material, firm. Modern made ground.            |       |      |
| 2302  | Layer               |         | 2.2       |           | Natural. Mid yellowish brown, clayey gravel, firm.                              |       |      |
| 2303  | Cut                 |         | 0.45      | 0.08      | Natural Feature. Mid brownish grey, silty clay, firm.                           |       |      |
| <b>Trench 24</b>  |                     |         |           |           |   |       |      |
| General description   |                     |         |           |           | Orientation   | N-S   |      |
| Trench consists of a ploughsoil overlying a subsoil and a natural of sandy gravel. Trench contains one ditch  |                     |         |           |           | Length (m)  | 30    |      |
|   |                     |         |           |           | Width (m)   | 2     |      |
|   |                     |         |           |           | Avg. depth (m)  | 0.5   |      |
| Context No.   | Type                | Fill Of | Width (m) | Depth (m) | Description   | Finds | Date |
| 2400  | Layer               |         | 2.2       | 0.2       | Ploughsoil. Dark greyish brown, clayey silt, loose.                             |       |      |
| 2401  | Layer               |         | 2.2       | 0.15      | Subsoil. Mid greyish brown, silty clay, firm.                                   |       |      |
| 2402  | Layer               |         | 2.2       |           | Natural. Mid reddish brown, silty clay, firm.                                   |       |      |
| 2403  | Cut                 |         | 0.2       | 0.06      | Ditch. Possibly a ploughscar  |       |      |
| 2404  | Fill                | 2403    | 0.2       | 0.06      | Secondary Fill. Dark brownish grey, clayey silt, firm                           |       |      |
| <b>Trench 25</b>  |                     |         |           |           |   |       |      |
| General description   |                     |         |           |           | Orientation   | E-W   |      |
| Trench consists of a ploughsoil overlying a natural of silty clay with frequent gravel. Trench contains one ditch.  |                     |         |           |           | Length (m)  | 30    |      |
|   |                     |         |           |           | Width (m)   | 2.2   |      |

|             |       |         |           |           |   | Avg. depth (m) | 0.3  |
|-------------|-------|---------|-----------|-----------|---|----------------|------|
| Context No. | Type  | Fill Of | Width (m) | Depth (m) | Description   | Finds          | Date |
| 2500        | Layer |         | 2.2       | 0.3       | Ploughsoil. Dark brownish grey, sandy silt, friable               |                |      |
| 2501        | Layer |         | 2.2       |           | Natural. Mid greyish brown, silty clay with frequent gravel, firm |                |      |
| 2502        | Cut   |         | 0.95      | 0.37      | Ditch   |                |      |
| 2503        | Fill  | 2502    | 0.95      | 0.37      | Secondary Fill. Dark grey brown, sandy clay, firm.                |                |      |

### Trench 26

| General description  |       |         |           |           |   | Orientation    | NE-SW |
|--|-------|---------|-----------|-----------|---|----------------|-------|
| Trench consists of a ploughsoil overlying a subsoil and a natural of silty clay. Trench devoid of archaeology. |       |         |           |           |   | Length (m)     | 30    |
|  |       |         |           |           |   | Width (m)      | 2     |
|  |       |         |           |           |   | Avg. depth (m) | 0.5   |
| Context No.  | Type  | Fill Of | Width (m) | Depth (m) | Description   | Finds          | Date  |
| 2600   | Layer |         | 2.2       | 0.2       | Ploughsoil. Dark greyish brown, clayey silt, friable.                         |                |       |
| 2601   | Layer |         | 2.2       | 0.2       | Other Layer. Dark greyish brown, silty clay, firm. Likely modern made ground. |                |       |
| 2602   | Layer |         | 2.2       |           | Natural. Mid greyish brown, gravelly clay, firm.                              |                |       |
| 2603   | Cut   |         | 0.82      | 0.02      | Natural Feature. Mid greyish brown, gravelly silt, firm. Possible hollow.     |                |       |

### Trench 27

| General description   |       |         |           |           |   | Orientation    | NE-SW |
|---|-------|---------|-----------|-----------|---|----------------|-------|
| Trench consists of a ploughsoil overlying a natural of silty clay with frequent gravel. Trench devoid of archaeology. |       |         |           |           |   | Length (m)     | 30    |
|   |       |         |           |           |   | Width (m)      | 2.2   |
|   |       |         |           |           |   | Avg. depth (m) | 0.36  |
| Context No.   | Type  | Fill Of | Width (m) | Depth (m) | Description   | Finds          | Date  |
| 2700  | Layer |         | 2.2       | 0.36      | Ploughsoil. Dark brownish grey, sandy silt, friable                 |                |       |
| 2701  | Layer |         | 2.2       |           | Natural. Light greyish brown, silty clay with frequent gravel, firm |                |       |

### Trench 28

| General description |  |  |  |  |  | Orientation | N-S |
|---------------------|--|--|--|--|--|-------------|-----|
|---------------------|--|--|--|--|--|-------------|-----|

| Trench consist of a ploughsoil overlying a subsoil and a natural of silty clay with frequent gravel. Trench devoid of archaeology.                                 |       |         |           |           |  | Length (m)     | 30    |
|--|-------|---------|-----------|-----------|--|----------------|-------|
|  |       |         |           |           |  | Width (m)      | 2     |
|  |       |         |           |           |  | Avg. depth (m) | 0.4   |
| Context No.  | Type  | Fill Of | Width (m) | Depth (m) | Description  | Finds          | Date  |
| 2800   | Layer |         | 2.2       | 0.23      | Ploughsoil. Dark greyish brown, clayey silt, friable                 |                |       |
| 2801   | Layer |         | 2.2       | 0.1       | Subsoil. Dark greyish brown, silty clay, firm.                       |                |       |
| 2802   | Layer |         | 2.2       |           | Natural. Mid reddish brown, silty clay, firm                         |                |       |
| <b>Trench 29</b>   |       |         |           |           |  |                |       |
| General description  |       |         |           |           |  | Orientation    | E-W   |
| Trench consists of a ploughsoil overlying a subsoil and a natural of silty clay. Trench contains one posthole, one modern ditch and one natural feature.           |       |         |           |           |  | Length (m)     | 30    |
|  |       |         |           |           |  | Width (m)      | 2     |
|  |       |         |           |           |  | Avg. depth (m) | 0.4   |
| Context No.  | Type  | Fill Of | Width (m) | Depth (m) | Description  | Finds          | Date  |
| 2900   | Layer |         | 2.2       | 0.23      | Ploughsoil. Dark greyish brown, clayey silt, friable.                |                |       |
| 2901   | Layer |         | 2.2       | 0.1       | Subsoil. Dark greyish brown, silty clay, firm.                       |                |       |
| 2902   | Layer |         | 2.2       |           | Natural. Mid reddish brown, silty clay, firm.                        |                |       |
| 2903   | Cut   |         | 0.16      | 0.08      | Posthole   |                |       |
| 2904   | Fill  | 2903    | 0.16      | 0.08      | Secondary Fill. Mid brownish grey, silty clay, firm.                 |                |       |
| 2905   | Cut   |         | 0.5       | 0.15      | Natural Feature. Mid grey brown, silty clay, hard, slightly plastic. |                |       |
| 2906   | Cut   |         | 1.8       | 0.16      | Ditch. Likely modern   |                |       |
| 2907   | Fill  | 2906    | 1.8       | 0.16      | Secondary Fill. Mid greyish brown, silty clay, firm.                 |                |       |
| <b>Trench 30</b>   |       |         |           |           |  |                |       |
| General description  |       |         |           |           |  | Orientation    | NW-SE |
| Trench consists of ploughsoil overlying a subsoil and a natural of silty clay with frequent gravel. Trench contains one natural feature and one unexcavated ditch. |       |         |           |           |  | Length (m)     | 30    |
|  |       |         |           |           |  | Width (m)      | 2     |
|  |       |         |           |           |  | Avg. depth (m) | 0.35  |
| Context No.  | Type  | Fill Of | Width (m) | Depth (m) | Description  | Finds          | Date  |
| 3000   | Layer |         | 2.2       | 0.23      | Ploughsoil. Mid greyish brown, clayey silt, friable.                 |                |       |

|      |                     |  |      |      |   |  |  |
|------|---------------------|--|------|------|---|--|--|
| 3001 | Layer               |  | 2.2  | 0.05 | Subsoil. Mid greyish brown, silty clay, firm.                     |  |  |
| 3002 | Layer               |  | 2.2  |      | Natural. Mid greyish brown, silty clay, firm.                     |  |  |
| 3003 | Cut                 |  | 1.3  | 0.2  | Natural Feature. Mid brownish grey, silty clay, firm. Tree-throw. |  |  |
| 3004 | Unexcavated feature |  | 1.53 |      | Ditch. Mid greyish brown, silty clay, firm.                       |  |  |

### Trench 31

| General description  |       |         |           |           | Orientation  | NE-SW |      |
|--|-------|---------|-----------|-----------|--|-------|------|
| Trench consists of a ploughsoil overlying a natural of silty clay. Trench devoid of archaeology. |       |         |           |           | Length (m)   | 30    |      |
|  |       |         |           |           | Width (m)  | 2.1   |      |
|  |       |         |           |           | Avg. depth (m)   | 0.35  |      |
| Context No.  | Type  | Fill Of | Width (m) | Depth (m) | Description  | Finds | Date |
| 3100   | Layer |         | 2.2       | 0.35      | Ploughsoil. Mid greyish brown, sandy silt, moderately compact. |       |      |
| 3101   | Layer |         | 2.2       |           | Natural. Mid reddish brown, silty clay, firm.                  |       |      |

### Trench 32

| General description  |       |         |           |           | Orientation   | E-W   |      |
|--|-------|---------|-----------|-----------|---|-------|------|
| Trench consists of a ploughsoil overlying a natural of silty clay. Trench revealed one ditch and three natural features. |       |         |           |           | Length (m)  | 30    |      |
|  |       |         |           |           | Width (m)   | 2.1   |      |
|  |       |         |           |           | Avg. depth (m)  | 0.34  |      |
| Context No.  | Type  | Fill Of | Width (m) | Depth (m) | Description   | Finds | Date |
| 3200   | Layer |         | 2.2       | 0.34      | Ploughsoil. Mid greyish brown, clayey silt, moderately compact.               |       |      |
| 3201   | Layer |         | 2.2       |           | Natural. Mid reddish brown, silty clay, firm.                                 |       |      |
| 3202   | Cut   |         | 0.49      | 0.09      | Natural Feature. Dark orangish brown, clayey silt, firm. Possible tree-throw. |       |      |
| 3203   | Cut   |         | 0.79      | 0.04      | Natural Feature. Mid orangish brown, clayey silt, firm. Possible tree-throw.  |       |      |
| 3204   | Cut   |         | 0.58      | 0.04      | Natural Feature. Mid orangish brown,  |       |      |

|  |                     |         |           |           | clayey silt, firm.<br>Possible tree-throw.              |       |      |
|--|---------------------|---------|-----------|-----------|---|-------|------|
| 3205   | Unexcavated feature |         | 0.8       |           | Ditch. Dark greyish brown, clayey silt, firm.           |       |      |
| <b>Trench 33</b>   |                     |         |           |           |   |       |      |
| General description  |                     |         |           |           | Orientation   | E-W   |      |
| Trench consists of topsoil overlaying natural geology of clay.<br>Trench contains one natural feature. |                     |         |           |           | Length (m)  | 30    |      |
|  |                     |         |           |           | Width (m)   | 2.2   |      |
|  |                     |         |           |           | Avg. depth (m)  | 0.3   |      |
| Context No.  | Type                | Fill Of | Width (m) | Depth (m) | Description   | Finds | Date |
| 3300   | Layer               |         | 2.2       | 0.3       | Topsoil. Loose, dark greyish brown, silty clay.         |       |      |
| 3301   | Layer               |         | 2.2       |           | Natural. Compact, mid orangish brown, silty clay.       |       |      |
| 3302   | Cut                 |         | 0.6       |           | Natural Feature. Compact, mid greyish brown, silty clay |       |      |
| <b>Trench 34</b>   |                     |         |           |           |   |       |      |
| General description  |                     |         |           |           | Orientation   | E-W   |      |
| Trench consists of a topsoil overlying a natural of silty clay.<br>Trench devoid of archaeology.       |                     |         |           |           | Length (m)  | 30    |      |
|  |                     |         |           |           | Width (m)   | 2.2   |      |
|  |                     |         |           |           | Avg. depth (m)  | 0.25  |      |
| Context No.  | Type                | Fill Of | Width (m) | Depth (m) | Description   | Finds | Date |
| 3400   | Layer               |         | 2.2       | 0.25      | Topsoil. Loose, dark greyish brown, clayey silt.        |       |      |
| 3401   | Layer               |         | 2.2       |           | Natural. Compact, mid orangish brown, silty clay.       |       |      |
| <b>Trench 35</b>   |                     |         |           |           |   |       |      |
| General description  |                     |         |           |           | Orientation   | NW-SE |      |
| Trench consists of a topsoil overlying a natural of silty clay.<br>Trench devoid of archaeology.       |                     |         |           |           | Length (m)  | 20    |      |
|  |                     |         |           |           | Width (m)   | 2.2   |      |
|  |                     |         |           |           | Avg. depth (m)  | 0.35  |      |
| Context No.  | Type                | Fill Of | Width (m) | Depth (m) | Description   | Finds | Date |
| 3500   | Layer               |         | 2.2       | 0.35      | Topsoil. Loose, dark greyish brown, clayey silt.        |       |      |
| 3501   | Layer               |         | 2.2       |           | Natural. Compact, mid greyish brown, silty clay.        |       |      |
| <b>Trench 36</b>   |                     |         |           |           |   |       |      |
| General description  |                     |         |           |           | Orientation   | NW-SE |      |

| Trench consists of topsoil overlaying natural of silty clay. Trench devoid of archaeology. |       |         |           |           |  | Length (m)     | 30   |
|--|-------|---------|-----------|-----------|--|----------------|------|
|  |       |         |           |           |  | Width (m)      | 2.2  |
|  |       |         |           |           |  | Avg. depth (m) | 0.25 |
| Context No.  | Type  | Fill Of | Width (m) | Depth (m) | Description                                      | Finds          | Date |
| 3600   | Layer |         | 2.2       | 0.25      | Topsoil. Loose, dark greyish brown, clayey silt. |                |      |
| 3601   | Layer |         | 2.2       |           | Natural. Compact, mid greyish brown, silty clay. |                |      |

### Trench 37

| General description   |       |         |           |           |  | Orientation                                   | N-S        |
|---|-------|---------|-----------|-----------|--|---|------------|
| Trench consists of topsoil overlaying natural of silty clay. Trench contains one large pit. |       |         |           |           |  | Length (m)                                    | 30         |
|   |       |         |           |           |  | Width (m)                                     | 2.2        |
|   |       |         |           |           |  | Avg. depth (m)                                | 0.25       |
| Context No.   | Type  | Fill Of | Width (m) | Depth (m) | Description  | Finds   | Date       |
| 3700  | Layer |         | 2.2       | 0.25      | Topsoil. Loose, dark greyish brown, clayey silt.                         |   |            |
| 3701  | Layer |         | 2.2       |           | Natural. Compact, mid greyish brown, silty clay.                         |   |            |
| 3702  | Cut   |         | 1.72      | 0.9       | Pit. Very unclear in plan, could be a ditch terminus.                    |   |            |
| 3703  | Fill  | 3702    | 1.58      | 0.16      | Secondary Fill. Mid brownish grey with orange mottling, soft, silty clay | Pot, shell                                    | AD 270–300 |
| 3704  | Fill  | 3702    | 1.72      | 0.34      | Secondary Fill. Mid brownish grey, silty clay, soft                      | Pot, CBM, fired clay, animal bone, shell      | AD 270–300 |
| 3705  | Fill  | 3702    | 1.38      | 0.3       | Secondary Fill. Dark brownish grey, silty clay, soft                     | Pot, fired clay, Fe nail?, animal bone, shell | AD 270–300 |
| 3706  | Fill  | 3702    | 0.88      | 0.34      | Tertiary Fill. Mid reddish brown, silty clay, firm                       |   |            |

### Trench 38

|  |  |  |  |  |  |                |      |
|--|--|--|--|--|--|----------------|------|
| General description  |  |  |  |  |  | Orientation    | N-S  |
| Trench consists of topsoil overlaying natural of silty clay. Trench devoid of archaeology. |  |  |  |  |  | Length (m)     | 30   |
|  |  |  |  |  |  | Width (m)      | 2.2  |
|  |  |  |  |  |  | Avg. depth (m) | 0.35 |

| Context No.  | Type  | Fill Of | Width (m) | Depth (m) | Description  | Finds | Date       |
|--|-------|---------|-----------|-----------|--|-------|------------|
| 3800   | Layer |         | 2.2       | 0.35      | Topsoil. Loose, dark greyish brown, clayey silt.     |       |            |
| 3801   | Layer |         | 2.2       |           | Natural. Compact, mid greyish brown, silty clay.     |       |            |
| <b>Trench 39</b>   |       |         |           |           |  |       |            |
| General description  |       |         |           |           | Orientation  | E-W   |            |
| Trench consists of topsoil overlying a natural of silty clay.<br>Trench contains one ditch.            |       |         |           |           | Length (m)   | 30    |            |
|  |       |         |           |           | Width (m)  | 2.2   |            |
|  |       |         |           |           | Avg. depth (m)                                       | 0.3   |            |
| Context No.  | Type  | Fill Of | Width (m) | Depth (m) | Description  | Finds | Date       |
| 3900   | Layer |         | 2.2       | 0.3       | Topsoil. Loose, dark greyish brown, clayey silt.     |       |            |
| 3901   | Layer |         | 2.2       |           | Natural. Compact, mid greyish brown, silty clay.     |       |            |
| 3902   | Cut   |         | 0.7       | 0.16      | Ditch  |       |            |
| 3903   | Fill  | 3902    | 0.7       | 0.16      | Secondary Fill. Mid greyish brown, silty clay, firm. | Pot   | AD 250–400 |
| <b>Trench 40</b>   |       |         |           |           |  |       |            |
| General description  |       |         |           |           | Orientation  | E-W   |            |
| Trench consists of ploughsoil overlying a natural of silty clay.<br>Trench devoid of archaeology.      |       |         |           |           | Length (m)   | 30    |            |
|  |       |         |           |           | Width (m)  | 2.2   |            |
|  |       |         |           |           | Avg. depth (m)                                       | 0.25  |            |
| Context No.  | Type  | Fill Of | Width (m) | Depth (m) | Description  | Finds | Date       |
| 4000   | Layer |         | 2.2       | 0.31      | Ploughsoil. Compact, mid brownish grey, silty clay.  |       |            |
| 4001   | Layer |         | 2.2       |           | Natural. Compact, mid reddish brown, silty clay      |       |            |
| <b>Trench 41</b>   |       |         |           |           |  |       |            |
| General description  |       |         |           |           | Orientation  | NE-SW |            |
| Trench consists of topsoil overlaying natural geology of clay.<br>Trench contains one natural feature. |       |         |           |           | Length (m)   | 30    |            |
|  |       |         |           |           | Width (m)  | 2.2   |            |
|  |       |         |           |           | Avg. depth (m)                                       | 0.3   |            |
| Context No.  | Type  | Fill Of | Width (m) | Depth (m) | Description  | Finds | Date       |
| 4100   | Layer |         | 2.2       | 0.3       | Topsoil. Loose, dark greyish brown, clayey silt.     |       |            |

| 4101   | Layer |         | 2.2       |           | Natural. Compact, mid greyish brown, silty clay.   |       |      |
|--|-------|---------|-----------|-----------|--|-------|------|
| 4102   | Cut   |         |           |           | Natural Feature                                    |       |      |
| <b>Trench 42</b>   |       |         |           |           |  |       |      |
| General description  |       |         |           |           | Orientation  | NE-SW |      |
| Trench consists of ploughsoil overlying a natural of silty clay. Trench devoid of archaeology. |       |         |           |           | Length (m)   | 25    |      |
|  |       |         |           |           | Width (m)  | 2.2   |      |
|  |       |         |           |           | Avg. depth (m)                                     | 0.4   |      |
| Context No.  | Type  | Fill Of | Width (m) | Depth (m) | Description  | Finds | Date |
| 4200   | Layer |         | 2.2       | 0.46      | Ploughsoil. Loose, mid brownish grey, clayey silt. |       |      |
| 4201   | Layer |         | 2.2       |           | Natural. Compact, mid greyish brown, silty clay.   |       |      |
| <b>Trench 43</b>   |       |         |           |           |  |       |      |
| General description  |       |         |           |           | Orientation  | N-S   |      |
| Trench consists of ploughsoil overlying a natural of silty clay. Trench devoid of archaeology  |       |         |           |           | Length (m)   | 30    |      |
|  |       |         |           |           | Width (m)  | 2.2   |      |
|  |       |         |           |           | Avg. depth (m)                                     | 0.3   |      |
| Context No.  | Type  | Fill Of | Width (m) | Depth (m) | Description  | Finds | Date |
| 4300   | Layer |         | 2.2       | 0.32      | Ploughsoil. Loose, mid brownish grey, clayey silt. |       |      |
| 4301   | Layer |         | 2.2       |           | Natural. Compact, mid greyish brown, silty clay.   |       |      |
| <b>Trench 44</b>   |       |         |           |           |  |       |      |
| General description  |       |         |           |           | Orientation  | NE-SW |      |
| Trench consists of ploughsoil overlying a natural of silty clay. Trench devoid of archaeology. |       |         |           |           | Length (m)   | 30    |      |
|  |       |         |           |           | Width (m)  | 2.2   |      |
|  |       |         |           |           | Avg. depth (m)                                     | 0.3   |      |
| Context No.  | Type  | Fill Of | Width (m) | Depth (m) | Description  | Finds | Date |
| 4400   | Layer |         | 2.2       | 0.3       | Ploughsoil. Loose, mid brownish grey, clayey silt. |       |      |
| 4401   | Layer |         | 2.2       |           | Natural. Compact, mid reddish brown, silty clay    |       |      |
| <b>Trench 45</b>   |       |         |           |           |  |       |      |
| General description  |       |         |           |           | Orientation  | NW-SE |      |
| Trench consists of ploughsoil overlying a natural of silty clay. Trench devoid of archaeology. |       |         |           |           | Length (m)   | 30    |      |
|  |       |         |           |           | Width (m)  | 2.2   |      |
|  |       |         |           |           | Avg. depth (m)                                     | 0.35  |      |



| Context No. | Type  | Fill Of | Width (m) | Depth (m) | Description   | Finds | Date |
|-------------|-------|---------|-----------|-----------|---|-------|------|
| 4500        | Layer |         | 2.2       | 0.35      | Ploughsoil. Loose, dark brownish grey, clayey silt. |       |      |
| 4501        | Layer |         | 2.2       |           | Natural. Compact, mid greyish brown, silty clay.    |       |      |

#### Trench 46

|   |  |  |  |  |                |      |
|---|--|--|--|--|----------------|------|
| General description   |  |  |  |  | Orientation    | N-S  |
| Trench consists of a ploughsoil overlying a natural of silty clay. Trench revealed one ditch. |  |  |  |  | Length (m)     | 30   |
|   |  |  |  |  | Width (m)      | 2.2  |
|   |  |  |  |  | Avg. depth (m) | 0.35 |

| Context No. | Type  | Fill Of | Width (m) | Depth (m) | Description   | Finds                   | Date         |
|-------------|-------|---------|-----------|-----------|---|-------------------------|--------------|
| 4600        | Layer |         | 2.2       | 0.36      | Ploughsoil. Loose, mid brownish grey, clayey silt.                            |                         |              |
| 4601        | Layer |         | 2.2       |           | Natural. Compact, mid reddish brown, silty clay                               |                         |              |
| 4602        | Cut   |         | 1.62      | 0.54      | Ditch   |                         |              |
| 4603        | Fill  |         | 1.34      | 0.16      | Primary Fill. Compact, light blueish grey, silty clay                         | Pot, animal bone, shell | AD 900–1050? |
| 4604        | Fill  | 4602    | 1.2       | 0.12      | Secondary Fill. Mid brownish grey, silty clay, compact                        |                         |              |
| 4605        | Fill  | 4602    | 1.38      | 0.18      | Secondary Fill. Compact, mid grey with mid yellowish brown lenses, silty clay |                         |              |
| 4606        | Fill  | 4602    | 1.62      | 0.15      | Secondary Fill. Compact, mid brownish grey, silty clay                        | Pot, animal bone        | AD 900–1050  |

#### Trench 47

|   |  |  |  |  |                |       |
|---|--|--|--|--|----------------|-------|
| General description   |  |  |  |  | Orientation    | NW-SE |
| Trench consists of ploughsoil overlying a subsoil and a natural of silty clay. Trench contains five pits. |  |  |  |  | Length (m)     | 30    |
|   |  |  |  |  | Width (m)      | 2.2   |
|   |  |  |  |  | Avg. depth (m) | 0.35  |

| Context No. | Type  | Fill Of | Width (m) | Depth (m) | Description   | Finds | Date |
|-------------|-------|---------|-----------|-----------|---|-------|------|
| 4700        | Layer |         | 2.2       | 0.35      | Ploughsoil. Loose, dark brownish grey, clayey silt. |       |      |
| 4701        | Layer |         | 2.2       |           | Natural. Compact, mid greyish brown, silty clay.    |       |      |
| 4702        | Cut   |         | 0.7       | 0.09      | Pit   |       |      |

|      |       |      |      |      |   |                      |                |
|------|-------|------|------|------|---|----------------------|----------------|
| 4703 | Fill  | 4702 | 0.7  | 0.09 | Secondary Fill. Dark greyish brown, silty clay, firm                                      | Pot                  | AD 1000 –1225? |
| 4704 | Cut   |      | 0.68 | 0.07 | Pit   |                      |                |
| 4705 | Fill  | 4704 | 0.68 | 0.07 | Secondary Fill. Dark greyish brown, silty clay, firm                                      |                      |                |
| 4706 | Cut   |      | 0.44 | 0.12 | Pit   |                      |                |
| 4707 | Fill  | 4706 | 0.44 | 0.12 | Secondary Fill. Dark greyish brown, silty clay, firm                                      |                      |                |
| 4708 | Cut   |      | 1.16 | 0.53 | Pit   |                      |                |
| 4709 | Fill  | 4708 | 1.16 | 0.53 | Secondary Fill. Dark greyish brown, silty clay, firm                                      | Pot, CBM, fired clay | AD 900–1050    |
| 4710 | Cut   |      | 0.5  | 0.08 | Pit   |                      |                |
| 4711 | Fill  | 4710 | 0.5  | 0.08 | Secondary Fill. Dark greyish brown, silty clay, firm                                      |                      |                |
| 4712 | Layer |      | 2.2  |      | Subsoil. Mid orangish brown, silty clay, firm. Possibly an interface rather than subsoil. |                      |                |

#### Trench 48

| General description  |       |         |           |           | Orientation  | N-S   |      |
|--|-------|---------|-----------|-----------|--|-------|------|
| Trench consists of a ploughsoil overlying a natural of silty clay. Trench devoid of archaeology. |       |         |           |           | Length (m)   | 30    |      |
|  |       |         |           |           | Width (m)  | 2.2   |      |
|  |       |         |           |           | Avg. depth (m)                                     | 0.35  |      |
| Context No.  | Type  | Fill Of | Width (m) | Depth (m) | Description  | Finds | Date |
| 4800   | Layer |         | 2.2       | 0.38      | Ploughsoil. Loose, mid brownish grey, clayey silt. |       |      |
| 4801   | Layer |         | 2.2       |           | Natural. Compact, mid reddish brown, silty clay.   |       |      |

#### Trench 49

| General description  |       |         |           |           | Orientation  | E-W   |      |
|--|-------|---------|-----------|-----------|--|-------|------|
| Trench consists of a ploughsoil overlying a natural of silty clay. Trench devoid of archaeology. |       |         |           |           | Length (m)   | 30    |      |
|  |       |         |           |           | Width (m)  | 2.2   |      |
|  |       |         |           |           | Avg. depth (m)                                     | 0.35  |      |
| Context No.  | Type  | Fill Of | Width (m) | Depth (m) | Description  | Finds | Date |
| 4900   | Layer |         | 2.2       | 0.39      | Ploughsoil. Loose, mid brownish grey, clayey silt. |       |      |
| 4901   | Layer |         | 2.2       |           | Natural. Compact, mid reddish brown, silty clay    |       |      |

| Trench 50  |                     |         |           |           |  |                                       |                              |
|--|---------------------|---------|-----------|-----------|--|---------------------------------------|------------------------------|
| General description  |                     |         |           |           | Orientation  |                                       | N-S                          |
| Trench consists of a ploughsoil overlying a natural of silty clay. Trench contains two ditches, four pits and two unexcavated features |                     |         |           |           | Length (m)   |                                       | 30                           |
|  |                     |         |           |           | Width (m)  |                                       | 2.2                          |
|  |                     |         |           |           | Avg. depth (m)   |                                       | 0.3                          |
| Context No.  | Type                | Fill Of | Width (m) | Depth (m) | Description  | Finds                                 | Date                         |
| 5000   | Layer               |         | 2.2       | 0.3       | Ploughsoil. Loose, mid brownish grey, clayey silt.       | Animal bone                           |                              |
| 5001   | Layer               |         | 2.2       |           | Natural. Compact, mid reddish brown, silty clay          |                                       |                              |
| 5002   | Cut                 |         | 0.68      | 0.13      | Pit  |                                       |                              |
| 5003   | Fill                | 5002    | 0.68      | 0.17      | Secondary Fill. Compact, dark blackish brown, silty clay | Pot, CBM                              | AD 1000 –1225?               |
| 5004   | Cut                 |         | 0.84      | 0.24      | Ditch  |                                       |                              |
| 5005   | Fill                | 5004    | 0.84      | 0.24      | Primary Fill. Dark greyish brown, silty clay, compact    | Pot, CBM, animal bone, shell          | AD 1000 –1225 (res), L18/19C |
| 5006   | Cut                 |         | 0.38      | 0.12      | Ditch  |                                       |                              |
| 5007   | Fill                | 5006    | 0.38      | 0.12      | Primary Fill. Dark greyish brown, silty clay, compact    | Pot                                   | AD 1000 –1225?               |
| 5008   | Cut                 |         | 0.65      | 0.19      | Pit  |                                       |                              |
| 5009   | Fill                | 5008    | 0.65      | 0.08      | Primary Fill. Light orangish brown, silty clay, firm     |                                       |                              |
| 5010   | Fill                | 5008    | 0.38      | 0.11      | Primary Fill. Dark greyish brown, silty clay, firm       |                                       |                              |
| 5011   | Cut                 |         | 1.57      | 0.38      | Pit  |                                       |                              |
| 5012   | Fill                | 5011    | 1.57      | 0.14      | Primary Fill. Light orangish brown, silty clay, firm     | Pot, fired clay, animal bone          | AD 1200 –1400                |
| 5013   | Fill                | 5011    | 1.09      | 0.24      | Primary Fill. Dark greyish brown, silty clay, firm.      | Pot, Fe nail, fired clay, animal bone | AD 1200 –1350, PMed?         |
| 5014   | Cut                 |         | 1.4       |           | Natural Feature. Compact greyish brown, silty clay.      | Fired clay, animal bone, shell        |                              |
| 5015   | Unexcavated feature |         | 0.5       |           | Ditch  |                                       |                              |
| 5016   | Unexcavated feature |         |           |           | Pit. Possible pit. Surface too diffuse to measure        |                                       |                              |

| 5017   | Cut   |         |           |           | Natural Feature.<br>Tree-throw  |                       |                            |
|--|-------|---------|-----------|-----------|---|-----------------------|----------------------------|
| <b>Trench 51</b>   |       |         |           |           |   |                       |                            |
| General description  |       |         |           |           | Orientation   | E-W                   |                            |
| Trench consists of ploughsoil overlaying a natural of silty clay.<br>One ditch and two natural features excavated. |       |         |           |           | Length (m)  | 30                    |                            |
|  |       |         |           |           | Width (m)   | 2.2                   |                            |
|  |       |         |           |           | Avg. depth (m)  | 0.35                  |                            |
| Context No.  | Type  | Fill Of | Width (m) | Depth (m) | Description   | Finds                 | Date                       |
| 5100   | Layer |         | 2.2       | 0.35      | Ploughsoil. Loose, dark brownish grey, clayey silt.   | Pot, CBM, animal bone | AD 1000 –1225? (res), PMed |
| 5101   | Layer |         | 2.2       |           | Natural. Compact, mid greyish brown, silty clay.  |                       |                            |
| 5102   | Cut   |         | 0.94      | 0.26      | Ditch   |                       |                            |
| 5103   | Fill  | 5102    | 0.94      | 0.26      | Primary Fill. Compact, mid greyish brown, silty clay.                                       | Flint, animal bone    |                            |
| 5104   | Cut   |         | 0.6       | 0.1       | Natural Feature. mid brownish grey, silty clay, firm  |                       |                            |
| 5105   | Cut   |         | 1.6       | 0.02      | Natural Feature. Mid brownish grey, silty clay, firm.                                       |                       |                            |
| <b>Trench 52</b>   |       |         |           |           |   |                       |                            |
| General description  |       |         |           |           | Orientation   | N-S                   |                            |
| Trench consists of a ploughsoil overlying a natural of silty clay.<br>Trench contains one ditch.                   |       |         |           |           | Length (m)  | 30                    |                            |
|  |       |         |           |           | Width (m)   | 2.2                   |                            |
|  |       |         |           |           | Avg. depth (m)  | 0.35                  |                            |
| Context No.  | Type  | Fill Of | Width (m) | Depth (m) | Description   | Finds                 | Date                       |
| 5200   | Layer |         | 2.2       | 0.39      | Ploughsoil. Loose, mid brownish grey, clayey silt.  |                       |                            |
| 5201   | Layer |         | 2.2       |           | Natural. Compact, mid reddish brown, silty clay   |                       |                            |
| 5202   | Cut   |         | 0.3       | 0.11      | Ditch   |                       |                            |
| 5203   | Fill  | 5202    | 0.1       | 0.3       | Secondary Fill. Compact, dark greyish brown, silty clay                                     | CBM                   | PMed                       |
| 5204   | Layer |         | 2.2       | 0.2       | Subsoil. Compact, mid greyish brown, silty clay. Possibly an interface rather than subsoil. |                       |                            |
| <b>Trench 53</b>   |       |         |           |           |   |                       |                            |
| General description  |       |         |           |           | Orientation   | E-W                   |                            |

| Trench consists of ploughsoil overlaying a natural of silty clay.<br>Trench devoid of archaeology. |       |         |           |           |  | Length (m)         | 30          |
|--|-------|---------|-----------|-----------|--|--------------------|-------------|
|  |       |         |           |           |  | Width (m)          | 2.2         |
|  |       |         |           |           |  | Avg. depth (m)     | 0.3         |
| Context No.  | Type  | Fill Of | Width (m) | Depth (m) | Description  | Finds              | Date        |
| 5300   | Layer |         | 2.2       | 0.3       | Ploughsoil. Loose, dark brownish grey, clayey silt.    |                    |             |
| 5301   | Layer |         | 2.2       |           | Natural. Compact, mid greyish brown, silty clay.       |                    |             |
| <b>Trench 54</b>   |       |         |           |           |  |                    |             |
| General description  |       |         |           |           |  | Orientation        | NW-SE       |
| Trench consists of ploughsoil overlaying a natural of silty clay.<br>Trench contains one ditch     |       |         |           |           |  | Length (m)         | 30          |
|  |       |         |           |           |  | Width (m)          | 2.2         |
|  |       |         |           |           |  | Avg. depth (m)     | 0.3         |
| Context No.  | Type  | Fill Of | Width (m) | Depth (m) | Description  | Finds              | Date        |
| 5400   | Layer |         | 2.2       | 0.3       | Ploughsoil. Loose, dark brownish grey, clayey silt.    |                    |             |
| 5401   | Layer |         | 2.2       |           | Natural. Compact, mid greyish brown, silty clay.       |                    |             |
| 5402   | Cut   |         | 0.7       | 0.2       | Ditch. Pos ditch. Uncertain.                           |                    |             |
| 5403   | Fill  | 5402    | 0.7       | 0.2       | Secondary Fill. Mid brownish grey, silty clay, firm.   | Pot                | E/MIA (res) |
| <b>Trench 55</b>   |       |         |           |           |  |                    |             |
| General description  |       |         |           |           |  | Orientation        | N-S         |
| Trench consists of ploughsoil overlaying a natural of silty clay.<br>Trench consists of one ditch. |       |         |           |           |  | Length (m)         | 30          |
|  |       |         |           |           |  | Width (m)          | 2.2         |
|  |       |         |           |           |  | Avg. depth (m)     | 0.25        |
| Context No.  | Type  | Fill Of | Width (m) | Depth (m) | Description  | Finds              | Date        |
| 5500   | Layer |         | 2.2       | 0.25      | Ploughsoil. Loose, dark brownish grey, clayey silt.    |                    |             |
| 5501   | Layer |         | 2.2       |           | Natural. Compact, mid greyish brown, silty clay.       |                    |             |
| 5502   | Cut   |         | 0.56      | 0.14      | Ditch  |                    |             |
| 5503   | Fill  | 5502    | 0.56      | 0.14      | Secondary Fill. Compact, mid greyish brown, silty clay | Animal bone, shell |             |
| <b>Trench 56</b>   |       |         |           |           |  |                    |             |
| General description  |       |         |           |           |  | Orientation        | E-W         |
|  |       |         |           |           |  | Length (m)         | 30          |

| Trench consists of ploughsoil overlaying a natural of silty clay.<br>Trench devoid of archaeology.    |       |         |           |           |   | Width (m)      | 2.2  |
|---|-------|---------|-----------|-----------|---|----------------|------|
|   |       |         |           |           |   | Avg. depth (m) | 0.3  |
| Context No.   | Type  | Fill Of | Width (m) | Depth (m) | Description   | Finds          | Date |
| 5600  | Layer |         | 2.2       | 0.3       | Ploughsoil. Loose, dark brownish grey, clayey silt. |                |      |
| 5601  | Layer |         | 2.2       |           | Natural. Compact, mid greyish brown, silty clay.    |                |      |
| <b>Trench 57</b>  |       |         |           |           |   |                |      |
| General description   |       |         |           |           |   | Orientation    | N-S  |
| Trench consists of ploughsoil overlaying a natural of silty clay.<br>Trench devoid of archaeology.    |       |         |           |           |   | Length (m)     | 30   |
|   |       |         |           |           |   | Width (m)      | 2.2  |
|   |       |         |           |           |   | Avg. depth (m) | 0.3  |
| Context No.   | Type  | Fill Of | Width (m) | Depth (m) | Description   | Finds          | Date |
| 5700  | Layer |         | 2.2       | 0.3       | Ploughsoil. Loose, dark brownish grey, clayey silt. |                |      |
| 5701  | Layer |         | 2.2       |           | Natural. Compact, mid greyish brown, silty clay.    |                |      |
| <b>Trench 58</b>  |       |         |           |           |   |                |      |
| General description   |       |         |           |           |   | Orientation    | E-W  |
| Trench consists of ploughsoil overlaying natural geology of silty clay. Trench devoid of archaeology. |       |         |           |           |   | Length (m)     | 30   |
|   |       |         |           |           |   | Width (m)      | 2.2  |
|   |       |         |           |           |   | Avg. depth (m) | 0.3  |
| Context No.   | Type  | Fill Of | Width (m) | Depth (m) | Description   | Finds          | Date |
| 5800  | Layer |         | 2.2       | 0.3       | Ploughsoil. Loose, dark brownish grey, clayey silt. |                |      |
| 5801  | Layer |         | 2.2       |           | Natural. Compact, mid greyish brown, silty clay.    |                |      |
| <b>Trench 59</b>  |       |         |           |           |   |                |      |
| General description   |       |         |           |           |   | Orientation    | N-S  |
| Trench consists of a ploughsoil overlying a natural of silty clay.<br>Trench contains one pit.        |       |         |           |           |   | Length (m)     | 30   |
|   |       |         |           |           |   | Width (m)      | 2.2  |
|   |       |         |           |           |   | Avg. depth (m) | 0.25 |
| Context No.   | Type  | Fill Of | Width (m) | Depth (m) | Description   | Finds          | Date |
| 5900  | Layer |         | 2.2       | 0.25      | Ploughsoil. Loose, dark brownish grey, clayey silt. |                |      |
| 5901  | Layer |         | 2.2       |           | Natural. Compact, mid greyish brown, silty clay.    |                |      |

| 5902   | Cut   |         | 0.8       | 0.08      | Natural Feature. Mid grey brown, silty clay, firm.      |       |      |
|--|-------|---------|-----------|-----------|---|-------|------|
| <b>Trench 60</b>   |       |         |           |           |   |       |      |
| General description  |       |         |           |           | Orientation   |       | N-S  |
| Trench consists of a ploughsoil overlying a natural of silty clay.<br>Trench contains one natural feature. |       |         |           |           | Length (m)  |       | 30   |
|  |       |         |           |           | Width (m)   |       | 2.2  |
|  |       |         |           |           | Avg. depth (m)  |       | 0.3  |
| Context No.  | Type  | Fill Of | Width (m) | Depth (m) | Description   | Finds | Date |
| 6000   | Layer |         | 2.2       | 0.3       | Ploughsoil. Loose, dark brownish grey, clayey silt.     | CBM   |      |
| 6001   | Layer |         | 2.2       |           | Natural. Compact, dark greyish brown, silty clay.       |       |      |
| 6002   | Cut   |         | 1.4       | 0.02      | Natural Feature. Compact, mid grey brown, silty clay    |       |      |
| <b>Trench 61</b>   |       |         |           |           |   |       |      |
| General description  |       |         |           |           | Orientation   |       | E-W  |
| Trench consists of a ploughsoil overlying natural of silty clay.<br>Trench contains one natural feature.   |       |         |           |           | Length (m)  |       | 30   |
|  |       |         |           |           | Width (m)   |       | 2.2  |
|  |       |         |           |           | Avg. depth (m)  |       | 0.3  |
| Context No.  | Type  | Fill Of | Width (m) | Depth (m) | Description   | Finds | Date |
| 6100   | Layer |         | 2.2       | 0.3       | Ploughsoil. Loose, dark brownish grey, clayey silt.     |       |      |
| 6101   | Layer |         | 2.2       |           | Natural. Compact, mid greyish brown, silty clay.        |       |      |
| 6102   | Cut   |         | 0.9       | 0.06      | Natural Feature. Compact, mid greyish brown, silty clay |       |      |
| <b>Trench 62</b>   |       |         |           |           |   |       |      |
| General description  |       |         |           |           | Orientation   |       | N-S  |
| Trench consists of a ploughsoil overlaying a natural of silty clay.<br>Trench devoid of archaeology.       |       |         |           |           | Length (m)  |       | 30   |
|  |       |         |           |           | Width (m)   |       | 2.2  |
|  |       |         |           |           | Avg. depth (m)  |       | 0.25 |
| Context No.  | Type  | Fill Of | Width (m) | Depth (m) | Description   | Finds | Date |
| 6200   | Layer |         | 2.2       | 0.25      | Ploughsoil. Loose, dark brownish grey, clayey silt.     |       |      |
| 6201   | Layer |         | 2.2       |           | Natural. Compact, mid greyish brown, silty clay.        |       |      |
| <b>Trench 63</b>   |       |         |           |           |   |       |      |

| General description   |       |         |           |           |  | Orientation                   | E-W  |
|---|-------|---------|-----------|-----------|--|-------------------------------|------|
| Trench consists of a ploughsoil overlaying a natural of silty clay.<br>Trench revealed one ditch. |       |         |           |           |  | Length (m)                    | 30   |
|   |       |         |           |           |  | Width (m)                     | 2.2  |
|   |       |         |           |           |  | Avg. depth (m)                | 0.3  |
| Context No.   | Type  | Fill Of | Width (m) | Depth (m) | Description  | Finds                         | Date |
| 6300  | Layer |         | 2.2       | 0.3       | Ploughsoil. Loose, dark brownish grey, clayey silt.    |                               |      |
| 6301  | Layer |         | 2.2       |           | Natural. Compact, mid greyish brown, silty clay.       |                               |      |
| 6302  | Cut   |         | 1.02      | 0.28      | Ditch  |                               |      |
| 6303  | Fill  | 6302    | 1.02      | 0.28      | Primary Fill. Compact, dark greyish brown, silty clay. | Fe sheet, tarmac, animal bone |      |

#### Trench 64

| General description  |       |         |           |           |   | Orientation    | N-S  |
|--|-------|---------|-----------|-----------|---|----------------|------|
| Trench consists of a ploughsoil overlaying a natural of silty clay.<br>Trench devoid of archaeology. |       |         |           |           |   | Length (m)     | 30   |
|  |       |         |           |           |   | Width (m)      | 2.2  |
|  |       |         |           |           |   | Avg. depth (m) | 0.3  |
| Context No.  | Type  | Fill Of | Width (m) | Depth (m) | Description   | Finds          | Date |
| 6400   | Layer |         | 2.2       | 0.3       | Ploughsoil. Loose, dark brownish grey, clayey silt. |                |      |
| 6401   | Layer |         | 2.2       |           | Natural. Compact, mid greyish brown, silty clay.    |                |      |

#### Trench 65

| General description   |       |         |           |           |   | Orientation    | E-W  |
|---|-------|---------|-----------|-----------|---|----------------|------|
| Trench consists of a ploughsoil overlying a natural of silty clay.<br>Trench devoid of archaeology. |       |         |           |           |   | Length (m)     | 30   |
|   |       |         |           |           |   | Width (m)      | 2.2  |
|   |       |         |           |           |   | Avg. depth (m) | 0.3  |
| Context No.   | Type  | Fill Of | Width (m) | Depth (m) | Description   | Finds          | Date |
| 6500  | Layer |         | 2.2       | 0.3       | Ploughsoil. Loose, dark brownish grey, clayey silt. |                |      |
| 6501  | Layer |         | 2.2       |           | Natural. Compact, mid greyish brown, silty clay.    |                |      |

#### Trench 66

|   |  |  |  |  |  |                |       |
|---|--|--|--|--|--|----------------|-------|
| General description   |  |  |  |  |  | Orientation    | NE-SW |
| Trench consists of a ploughsoil overlying a natural of silty clay.<br>Trench devoid or archaeology. |  |  |  |  |  | Length (m)     | 30    |
|   |  |  |  |  |  | Width (m)      | 2.2   |
|   |  |  |  |  |  | Avg. depth (m) | 0.3   |



| Context No.  | Type  | Fill Of | Width (m) | Depth (m) | Description  | Finds | Date |
|--|-------|---------|-----------|-----------|--|-------|------|
| 6600   | Layer |         | 2.2       | 0.3       | Ploughsoil. Loose, dark brownish grey, clayey silt.                          |       |      |
| 6601   | Layer |         | 2.2       |           | Natural. Compact, mid greyish brown, silty clay.                             |       |      |
| <b>Trench 67</b>   |       |         |           |           |  |       |      |
| General description  |       |         |           |           | Orientation  | N-S   |      |
| Trench consists of a ploughsoil overlying a natural of silty clay. Trench devoid of archaeology. |       |         |           |           | Length (m)   | 30    |      |
|  |       |         |           |           | Width (m)  | 2.2   |      |
|  |       |         |           |           | Avg. depth (m)   | 0.3   |      |
| Context No.  | Type  | Fill Of | Width (m) | Depth (m) | Description  | Finds | Date |
| 6700   | Layer |         | 2.2       | 0.3       | Ploughsoil. Loose, dark brownish grey, clayey silt. Flecks of chalk.         |       |      |
| 6701   | Layer |         | 2.2       |           | Natural. Compact, mid greyish brown, silty clay. Occasional flecks of chalk. |       |      |
| <b>Trench 68</b>   |       |         |           |           |  |       |      |
| General description  |       |         |           |           | Orientation  | E-W   |      |
| Trench consists of a ploughsoil overlying a natural of silty clay. Trench devoid of archaeology. |       |         |           |           | Length (m)   | 30    |      |
|  |       |         |           |           | Width (m)  | 2.2   |      |
|  |       |         |           |           | Avg. depth (m)   | 0.25  |      |
| Context No.  | Type  | Fill Of | Width (m) | Depth (m) | Description  | Finds | Date |
| 6800   | Layer |         | 2.2       | 0.25      | Ploughsoil. Loose, dark brownish grey, clayey silt.                          |       |      |
| 6801   | Layer |         | 2.2       |           | Natural. Compact, dark greyish brown, silty clay.                            |       |      |
| <b>Trench 69</b>   |       |         |           |           |  |       |      |
| General description  |       |         |           |           | Orientation  | N-S   |      |
| Trench consist of a ploughsoil overlying a natural of silty clay. Trench devoid of archaeology.  |       |         |           |           | Length (m)   | 30    |      |
|  |       |         |           |           | Width (m)  | 2.2   |      |
|  |       |         |           |           | Avg. depth (m)   | 0.3   |      |
| Context No.  | Type  | Fill Of | Width (m) | Depth (m) | Description  | Finds | Date |
| 6900   | Layer |         | 2.2       | 0.3       | Ploughsoil. Loose, dark brownish grey, clayey silt.                          |       |      |
| 6901   | Layer |         | 2.2       |           | Natural. Compact, dark greyish brown, silty clay.                            |       |      |

| <b>Trench 70</b>   |       |         |           |           |  |       |      |
|--|-------|---------|-----------|-----------|--|-------|------|
| General description  |       |         |           |           | Orientation  |       | E-W  |
| Trench consists of ploughsoil overlying a natural of silty clay.<br>Trench contains one natural feature. |       |         |           |           | Length (m)   |       | 30   |
|  |       |         |           |           | Width (m)  |       | 2.2  |
|  |       |         |           |           | Avg. depth (m)   |       | 0.3  |
| Context No.  | Type  | Fill Of | Width (m) | Depth (m) | Description  | Finds | Date |
| 7000   | Layer |         | 2.2       | 0.3       | Ploughsoil. Loose, dark brownish grey, clayey silt.      |       |      |
| 7001   | Layer |         | 2.2       |           | Natural. Compact, dark greyish brown, silty clay.        |       |      |
| 7002   | Cut   |         | 1.7       |           | Natural Feature. Compact, mid greyish yellow, silty clay |       |      |
| <b>Trench 71</b>   |       |         |           |           |  |       |      |
| General description  |       |         |           |           | Orientation  |       | N-S  |
| Trench consists of a ploughsoil overlying a natural of silty clay.<br>Trench devoid of archaeology.      |       |         |           |           | Length (m)   |       | 30   |
|  |       |         |           |           | Width (m)  |       | 2.2  |
|  |       |         |           |           | Avg. depth (m)   |       | 0.3  |
| Context No.  | Type  | Fill Of | Width (m) | Depth (m) | Description  | Finds | Date |
| 7100   | Layer |         | 2.2       | 0.3       | Ploughsoil. Loose, dark brownish grey, clayey silt.      |       |      |
| 7101   | Layer |         | 2.2       |           | Natural. Compact, dark greyish brown, silty clay.        |       |      |
| <b>Trench 72</b>   |       |         |           |           |  |       |      |
| General description  |       |         |           |           | Orientation  |       | E-W  |
| Trench consists of a ploughsoil overlying a natural of silty clay.<br>Trench devoid of archaeology.      |       |         |           |           | Length (m)   |       | 30   |
|  |       |         |           |           | Width (m)  |       | 2.2  |
|  |       |         |           |           | Avg. depth (m)   |       | 0.3  |
| Context No.  | Type  | Fill Of | Width (m) | Depth (m) | Description  | Finds | Date |
| 7200   | Layer |         | 2.2       | 0.3       | Ploughsoil. Loose, dark brownish grey, clayey silt.      |       |      |
| 7201   | Layer |         | 2.2       |           | Natural. Compact, dark greyish brown, silty clay.        |       |      |
| <b>Trench 73</b>   |       |         |           |           |  |       |      |
| General description  |       |         |           |           | Orientation  |       | N-S  |
| Trench consists of a ploughsoil overlying a natural of silty clay.<br>Trench devoid of archaeology.      |       |         |           |           | Length (m)   |       | 30   |
|  |       |         |           |           | Width (m)  |       | 2.2  |
|  |       |         |           |           | Avg. depth (m)   |       | 0.25 |
| Context No.  | Type  | Fill Of | Width (m) | Depth (m) | Description  | Finds | Date |

|  |       |         |           |           |   |       |      |
|--|-------|---------|-----------|-----------|---|-------|------|
| 7300   | Layer |         | 2.2       | 0.25      | Ploughsoil. Loose, dark brownish grey, clayey silt. |       |      |
| 7301   | Layer |         | 2.2       |           | Natural. Compact, dark greyish brown, silty clay.   |       |      |
| <b>Trench 74</b>   |       |         |           |           |   |       |      |
| General description  |       |         |           |           | Orientation   |       | E-W  |
| Trench consists of a ploughsoil overlying a natural of silty clay. Trench devoid of archaeology. |       |         |           |           | Length (m)  |       | 30   |
|  |       |         |           |           | Width (m)   |       | 2.2  |
|  |       |         |           |           | Avg. depth (m)                                      |       | 0.3  |
| Context No.  | Type  | Fill Of | Width (m) | Depth (m) | Description   | Finds | Date |
| 7400   | Layer |         | 2.2       | 0.3       | Ploughsoil. Loose, dark brownish grey, clayey silt. |       |      |
| 7401   | Layer |         | 2.2       |           | Natural. Compact, dark greyish brown, silty clay.   |       |      |
| <b>Trench 75</b>   |       |         |           |           |   |       |      |
| General description  |       |         |           |           | Orientation   |       | N-S  |
| Trench consists of a ploughsoil overlying a natural of silty clay. Trench devoid of archaeology. |       |         |           |           | Length (m)  |       | 30   |
|  |       |         |           |           | Width (m)   |       | 2.2  |
|  |       |         |           |           | Avg. depth (m)                                      |       | 0.3  |
| Context No.  | Type  | Fill Of | Width (m) | Depth (m) | Description   | Finds | Date |
| 7500   | Layer |         | 2.2       | 0.3       | Ploughsoil. Loose, dark brownish grey, clayey silt. |       |      |
| 7501   | Layer |         | 2.2       |           | Natural. Compact, dark greyish brown, silty clay.   |       |      |
| <b>Trench 76</b>   |       |         |           |           |   |       |      |
| General description  |       |         |           |           | Orientation   |       | E-W  |
| Trench consists of a ploughsoil overlying a natural of silty clay. Trench devoid of archaeology. |       |         |           |           | Length (m)  |       | 30   |
|  |       |         |           |           | Width (m)   |       | 2.2  |
|  |       |         |           |           | Avg. depth (m)                                      |       | 0.34 |
| Context No.  | Type  | Fill Of | Width (m) | Depth (m) | Description   | Finds | Date |
| 7600   | Layer |         | 2.2       | 0.34      | Ploughsoil. Mid brownish grey, sandy silt, friable  |       |      |
| 7601   | Layer |         | 2.2       |           | Natural. Dark reddish brown, silty clay, firm       |       |      |
| <b>Trench 77</b>   |       |         |           |           |   |       |      |
| General description  |       |         |           |           | Orientation   |       | N-S  |
| Trench consists of a ploughsoil overlying a natural of silty clay. Trench devoid of archaeology. |       |         |           |           | Length (m)  |       | 30   |
|  |       |         |           |           | Width (m)   |       | 2.2  |

|   |       |         |           |           |   | Avg. depth (m) | 0.25 |
|---|-------|---------|-----------|-----------|---|----------------|------|
| Context No.   | Type  | Fill Of | Width (m) | Depth (m) | Description   | Finds          | Date |
| 7700  | Layer |         | 2.2       | 0.25      | Ploughsoil. Loose, dark brownish grey, clayey silt. |                |      |
| 7701  | Layer |         | 2.2       |           | Natural. Compact, mid greyish brown, silty clay.    |                |      |
| <b>Trench 78</b>  |       |         |           |           |   |                |      |
| General description   |       |         |           |           | Orientation   |                | E-W  |
| Trench consists of a ploughsoil overlying a natural of silty clay.<br>Trench devoid of archeology.  |       |         |           |           | Length (m)  |                | 30   |
|   |       |         |           |           | Width (m)   |                | 2.2  |
|   |       |         |           |           | Avg. depth (m)                                      |                | 0.3  |
| Context No.   | Type  | Fill Of | Width (m) | Depth (m) | Description   | Finds          | Date |
| 7800  | Layer |         | 2.2       | 0.3       | Ploughsoil. Loose, dark brownish grey, clayey silt. |                |      |
| 7801  | Layer |         | 2.2       |           | Natural. Compact, mid greyish brown, silty clay.    |                |      |
| <b>Trench 79</b>  |       |         |           |           |   |                |      |
| General description   |       |         |           |           | Orientation   |                | N-S  |
| Trench consists of a ploughsoil overlying a natural of silty clay.<br>Trench devoid of archaeology. |       |         |           |           | Length (m)  |                | 30   |
|   |       |         |           |           | Width (m)   |                | 2.2  |
|   |       |         |           |           | Avg. depth (m)                                      |                | 0.3  |
| Context No.   | Type  | Fill Of | Width (m) | Depth (m) | Description   | Finds          | Date |
| 7900  | Layer |         | 2.2       | 0.3       | Ploughsoil. Loose, dark brownish grey, clayey silt. |                |      |
| 7901  | Layer |         | 2.2       |           | Natural. Compact, mid greyish brown, silty clay.    |                |      |
| <b>Trench 80</b>  |       |         |           |           |   |                |      |
| General description   |       |         |           |           | Orientation   |                | E-W  |
| Trench consists of a ploughsoil overlying a natural of silty clay.<br>Trench devoid of archaeology. |       |         |           |           | Length (m)  |                | 30   |
|   |       |         |           |           | Width (m)   |                | 2.2  |
|   |       |         |           |           | Avg. depth (m)                                      |                | 0.37 |
| Context No.   | Type  | Fill Of | Width (m) | Depth (m) | Description   | Finds          | Date |
| 8000  | Layer |         | 2.2       | 0.37      | Ploughsoil. Mid greyish brown, clayey silt, friable |                |      |
| 8001  | Layer |         | 2.2       |           | Natural. Mid orange brown, silty clay, compact      |                |      |
| <b>Trench 81</b>  |       |         |           |           |   |                |      |

| General description   |       |         |           |           |   | Orientation    | NE-SW |
|---|-------|---------|-----------|-----------|---|----------------|-------|
| Trench consists of a ploughsoil overlying a natural of silty clay.<br>Trench devoid of archaeology. |       |         |           |           |   | Length (m)     | 30    |
|   |       |         |           |           |   | Width (m)      | 2.2   |
|   |       |         |           |           |   | Avg. depth (m) | 0.34  |
| Context No.   | Type  | Fill Of | Width (m) | Depth (m) | Description   | Finds          | Date  |
| 8100  | Layer |         | 2.2       | 0.34      | Ploughsoil. Mid greyish brown, clayey silt, friable |                |       |
| 8101  | Layer |         | 2.2       |           | Natural. Mid orange brown, silty clay, compact      |                |       |
| <b>Trench 82</b>  |       |         |           |           |   |                |       |
| General description   |       |         |           |           |   | Orientation    | E-W   |
| Trench consists of a ploughsoil overlying a natural of silty clay.<br>Trench devoid of archaeology. |       |         |           |           |   | Length (m)     | 30    |
|   |       |         |           |           |   | Width (m)      | 2.2   |
|   |       |         |           |           |   | Avg. depth (m) | 0.29  |
| Context No.   | Type  | Fill Of | Width (m) | Depth (m) | Description   | Finds          | Date  |
| 8200  | Layer |         | 2.2       | 0.31      | Ploughsoil. Mid greyish brown, clayey silt, friable |                |       |
| 8201  | Layer |         | 2.2       |           | Natural. Mid yellowish brown, silty clay, compact   |                |       |
| <b>Trench 83</b>  |       |         |           |           |   |                |       |
| General description   |       |         |           |           |   | Orientation    | N-S   |
| Trench consists of a ploughsoil overlying a natural of silty clay.<br>Trench devoid of archaeology. |       |         |           |           |   | Length (m)     | 30    |
|   |       |         |           |           |   | Width (m)      | 2.2   |
|   |       |         |           |           |   | Avg. depth (m) | 0.3   |
| Context No.   | Type  | Fill Of | Width (m) | Depth (m) | Description   | Finds          | Date  |
| 8300  | Layer |         | 2.2       | 0.3       | Ploughsoil. Loose, dark brownish grey, clayey silt. |                |       |
| 8301  | Layer |         | 2.2       |           | Natural. Compact, dark greyish brown, silty clay.   |                |       |
| <b>Trench 84</b>  |       |         |           |           |   |                |       |
| General description   |       |         |           |           |   | Orientation    | E-W   |
| Trench consists of a ploughsoil overlying a natural of silty clay.<br>Trench devoid of archaeology. |       |         |           |           |   | Length (m)     | 30    |
|   |       |         |           |           |   | Width (m)      | 2.2   |
|   |       |         |           |           |   | Avg. depth (m) | 0.3   |
| Context No.   | Type  | Fill Of | Width (m) | Depth (m) | Description   | Finds          | Date  |
| 8400  | Layer |         | 2.2       | 0.3       | Ploughsoil. Loose, dark brownish grey, clayey silt. |                |       |

| 8401   | Layer |         | 2.2       |           | Natural. Compact, dark brownish grey, silty clay.   |       |      |
|--|-------|---------|-----------|-----------|---|-------|------|
| <b>Trench 85</b>   |       |         |           |           |   |       |      |
| General description  |       |         |           |           | Orientation   | N-S   |      |
| Trench consists of a ploughsoil overlying a subsoil and a natural of silty clay. Trench devoid of archaeology. |       |         |           |           | Length (m)  | 30    |      |
|  |       |         |           |           | Width (m)   | 2.2   |      |
|  |       |         |           |           | Avg. depth (m)                                      | 0.45  |      |
| Context No.  | Type  | Fill Of | Width (m) | Depth (m) | Description   | Finds | Date |
| 8500   | Layer |         | 2.2       | 0.25      | Ploughsoil. Loose, dark brownish grey, clayey silt. |       |      |
| 8501   | Layer |         | 2.2       | 0.2       | Subsoil. Compact, mid orangish brown, silty clay.   |       |      |
| 8502   | Layer |         | 2.2       |           | Natural. Compact, mid orangish brown, silty clay.   |       |      |
| <b>Trench 86</b>   |       |         |           |           |   |       |      |
| General description  |       |         |           |           | Orientation   | E-W   |      |
| Trench consists of a ploughsoil overlying a subsoil and a natural of silty clay. Trench devoid of archaeology. |       |         |           |           | Length (m)  | 30    |      |
|  |       |         |           |           | Width (m)   | 2.2   |      |
|  |       |         |           |           | Avg. depth (m)                                      | 0.6   |      |
| Context No.  | Type  | Fill Of | Width (m) | Depth (m) | Description   | Finds | Date |
| 8600   | Layer |         | 2.2       | 0.3       | Ploughsoil. Loose, dark brownish grey, clayey silt. |       |      |
| 8601   | Layer |         | 2.2       | 0.3       | Subsoil. Compact, mid greyish brown, silty clay.    |       |      |
| 8602   | Layer |         | 2.2       |           | Natural. Compact, mid greyish brown, silty clay.    |       |      |
| <b>Trench 87</b>   |       |         |           |           |   |       |      |
| General description  |       |         |           |           | Orientation   | N-S   |      |
| Trench consists of a ploughsoil overlying a natural of silty clay. Trench devoid of archaeology.               |       |         |           |           | Length (m)  | 30    |      |
|  |       |         |           |           | Width (m)   | 2.2   |      |
|  |       |         |           |           | Avg. depth (m)                                      | 0.3   |      |
| Context No.  | Type  | Fill Of | Width (m) | Depth (m) | Description   | Finds | Date |
| 8700   | Layer |         | 2.2       | 0.3       | Ploughsoil. Loose, dark brownish grey, clayey silt. |       |      |
| 8701   | Layer |         | 2.2       |           | Natural. Compact, mid greyish brown, silty clay.    |       |      |
| <b>Trench 88</b>   |       |         |           |           |   |       |      |

| General description  |       |         |           |           |   | Orientation    | E-W   |
|--|-------|---------|-----------|-----------|---|----------------|-------|
| Trench consists of a ploughsoil overlying a natural of silty clay.<br>Trench devoid of archaeology.                                |       |         |           |           |   | Length (m)     | 30    |
|  |       |         |           |           |   | Width (m)      | 2.2   |
|  |       |         |           |           |   | Avg. depth (m) | 0.3   |
| Context No.  | Type  | Fill Of | Width (m) | Depth (m) | Description   | Finds          | Date  |
| 8800   | Layer |         | 2.2       | 0.3       | Ploughsoil. Loose, dark brownish grey, clayey silt.             |                |       |
| 8801   | Layer |         | 2.2       |           | Natural. Compact, mid greyish brown, silty clay.                |                |       |
| <b>Trench 89</b>   |       |         |           |           |   |                |       |
| General description  |       |         |           |           |   | Orientation    | NE-SW |
| Trench consists of a ploughsoil overlying a natural of silty clay.<br>Trench devoid of archaeology.                                |       |         |           |           |   | Length (m)     | 30    |
|  |       |         |           |           |   | Width (m)      | 2.2   |
|  |       |         |           |           |   | Avg. depth (m) | 0.24  |
| Context No.  | Type  | Fill Of | Width (m) | Depth (m) | Description   | Finds          | Date  |
| 8900   | Layer |         | 2.2       | 0.24      | Ploughsoil. Mid greyish brown, clayey silt, friable             |                |       |
| 8901   | Layer |         | 2.2       |           | Natural. Mid yellowish brown, silty clay, compact               |                |       |
| <b>Trench 90</b>   |       |         |           |           |   |                |       |
| General description  |       |         |           |           |   | Orientation    | E-W   |
| Trench consists of a ploughsoil overlying a natural of silty clay.<br>Trench devoid of archaeology.                                |       |         |           |           |   | Length (m)     | 30    |
|  |       |         |           |           |   | Width (m)      | 2.2   |
|  |       |         |           |           |   | Avg. depth (m) | 0.25  |
| Context No.  | Type  | Fill Of | Width (m) | Depth (m) | Description   | Finds          | Date  |
| 9000   | Layer |         | 2.2       | 0.25      | Ploughsoil. Mid greyish brown, clayey silt, friable             |                |       |
| 9001   | Layer |         | 2.2       |           | Natural. Mid orange brown, silty clay, compact                  |                |       |
| <b>Trench 91</b>   |       |         |           |           |   |                |       |
| General description  |       |         |           |           |   | Orientation    | N-S   |
| Trench consists of a ploughsoil overlying a subsoil and a natural of silty clay. Trench contains one pit and two natural features. |       |         |           |           |   | Length (m)     | 30    |
|  |       |         |           |           |   | Width (m)      | 2.2   |
|  |       |         |           |           |   | Avg. depth (m) | 0.5   |
| Context No.  | Type  | Fill Of | Width (m) | Depth (m) | Description   | Finds          | Date  |
| 9100   | Layer |         | 2.2       | 0.37      | Ploughsoil. Mid greyish brown, clayey silt, moderately compact. |                |       |

|      |       |      |      |      |  |  |  |
|------|-------|------|------|------|--|--|--|
| 9101 | Layer |      | 2.2  | 0.12 | Subsoil. Light greyish brown, clayey silt, firm.                       |  |  |
| 9102 | Layer |      | 2.2  |      | Natural. mid orangish brown, silty clay, firm.                         |  |  |
| 9103 | Cut   |      | 1.35 | 0.22 | Pit  |  |  |
| 9104 | Fill  | 9103 | 1.11 | 0.12 | Secondary Fill. Very compact mottled brown with red flecks silty clay. |  |  |
| 9105 | Fill  | 9103 | 1.35 | 0.16 | Secondary Fill. Very compact very dark grey silty clay                 |  |  |
| 9106 | Cut   |      | 0.28 | 0.16 | Natural Feature. Very compact, dark greyish black, silty clay          |  |  |
| 9107 | Cut   |      | 0.31 | 0.2  | Natural Feature. Very compact, dark greyish black, silty clay.         |  |  |

### Trench 92

| General description  |       |         |           |           | Orientation   | E-W   |      |
|--|-------|---------|-----------|-----------|---|-------|------|
| Trench consists of a ploughsoil overlying a subsoil and a natural of silty clay. Trench devoid of archaeology. |       |         |           |           | Length (m)  | 30    |      |
|  |       |         |           |           | Width (m)   | 2.2   |      |
|  |       |         |           |           | Avg. depth (m)  | 0.52  |      |
| Context No.  | Type  | Fill Of | Width (m) | Depth (m) | Description   | Finds | Date |
| 9200   | Layer |         | 2.2       | 0.37      | Ploughsoil. Mid greyish brown, clayey silt, moderately compact. |       |      |
| 9201   | Layer |         | 2.2       | 0.15      | Subsoil. Light greyish brown, clayey silt, firm.                |       |      |
| 9202   | Layer |         | 2.2       |           | Natural. mid orangish brown, silty clay, firm.                  |       |      |

### Trench 93

| General description   |       |         |           |           | Orientation   | N-S   |      |
|---|-------|---------|-----------|-----------|---|-------|------|
| Consists of a ploughsoil overlying a subsoil and a natural of silty clay. Trench devoid of archaeology. |       |         |           |           | Length (m)  | 30    |      |
|   |       |         |           |           | Width (m)   | 2.2   |      |
|   |       |         |           |           | Avg. depth (m)  | 0.48  |      |
| Context No.   | Type  | Fill Of | Width (m) | Depth (m) | Description   | Finds | Date |
| 9300  | Layer |         | 2.2       | 0.37      | Ploughsoil. Mid greyish brown, clayey silt, moderately compact. |       |      |



| 9301   | Layer |         | 2.2       | 0.11      | Subsoil. Light greyish brown, silty clay, firm.     |       |      |
|--|-------|---------|-----------|-----------|---|-------|------|
| 9302   | Layer |         | 2.2       |           | Natural. mid orangish brown, silty clay, firm.      |       |      |
| <b>Trench 94</b>   |       |         |           |           |   |       |      |
| General description  |       |         |           |           | Orientation   |       | E-W  |
| Trench consists of a ploughsoil overlying a subsoil and a natural of silty clay. Trench devoid of archaeology. |       |         |           |           | Length (m)  |       | 30   |
|  |       |         |           |           | Width (m)   |       | 2.2  |
|  |       |         |           |           | Avg. depth (m)                                      |       | 0.5  |
| Context No.  | Type  | Fill Of | Width (m) | Depth (m) | Description   | Finds | Date |
| 9400   | Layer |         |           | 0.25      | Ploughsoil. Loose dark brownish grey, clayey silt.  |       |      |
| 9401   | Layer |         | 2.2       | 0.25      | Subsoil. Compact, mid greyish brown, silty clay.    |       |      |
| 9402   | Layer |         | 2.2       |           | Natural. Compact, mid greyish brown, silty clay.    |       |      |
| <b>Trench 95</b>   |       |         |           |           |   |       |      |
| General description  |       |         |           |           | Orientation   |       | N-S  |
| Trench devoid of archaeology and consists of ploughsoil and subsoil overlaying natural geology of clay.        |       |         |           |           | Length (m)  |       | 30   |
|  |       |         |           |           | Width (m)   |       | 2.2  |
|  |       |         |           |           | Avg. depth (m)                                      |       | 0.5  |
| Context No.  | Type  | Fill Of | Width (m) | Depth (m) | Description   | Finds | Date |
| 9500   | Layer |         | 2.2       | 0.25      | Ploughsoil. Loose, dark brownish grey, clayey silt. |       |      |
| 9501   | Layer |         | 2.2       | 0.25      | Subsoil. Compact, mid greyish brown, silty clay.    |       |      |
| 9502   | Layer |         | 2.2       |           | Natural. Compact, mid greyish brown, silty clay.    |       |      |
| <b>Trench 96</b>   |       |         |           |           |   |       |      |
| General description  |       |         |           |           | Orientation   |       | E-W  |
| Trench consists of a ploughsoil overlying a natural of silty clay.   |       |         |           |           | Length (m)  |       | 30   |
|  |       |         |           |           | Width (m)   |       | 2.2  |
|  |       |         |           |           | Avg. depth (m)                                      |       | 0.25 |
| Context No.  | Type  | Fill Of | Width (m) | Depth (m) | Description   | Finds | Date |
| 9600   | Layer |         | 2.2       | 0.25      | Ploughsoil. Mid greyish brown, clayey silt, friable |       |      |
| 9601   | Layer |         | 2.2       |           | Natural. Mid orange brown, silty clay, compact      |       |      |

| <b>Trench 97</b>  |       |         |           |           |   |       |       |
|---|-------|---------|-----------|-----------|---|-------|-------|
| General description   |       |         |           |           | Orientation   |       | N-S   |
| Trench consists of a ploughsoil overlying a natural of silty clay.<br>Trench devoid of archaeology                                  |       |         |           |           | Length (m)  |       | 30    |
|   |       |         |           |           | Width (m)   |       | 2.2   |
|   |       |         |           |           | Avg. depth (m)  |       | 0.3   |
| Context No.   | Type  | Fill Of | Width (m) | Depth (m) | Description   | Finds | Date  |
| 9700  | Layer |         | 2.2       | 0.3       | Ploughsoil. Mid greyish brown, clayey silt, friable             |       |       |
| 9701  | Layer |         | 2.2       |           | Natural. Dark orange brown, silty clay, compact                 |       |       |
| <b>Trench 98</b>  |       |         |           |           |   |       |       |
| General description   |       |         |           |           | Orientation   |       | NW-SE |
| Trench consists of a ploughsoil overlying a natural of silty clay.<br>Trench devoid of archaeology                                  |       |         |           |           | Length (m)  |       | 30    |
|   |       |         |           |           | Width (m)   |       | 2.2   |
|   |       |         |           |           | Avg. depth (m)  |       | 0.3   |
| Context No.   | Type  | Fill Of | Width (m) | Depth (m) | Description   | Finds | Date  |
| 9800  | Layer |         | 2.2       | 0.3       | Ploughsoil. Mid greyish brown, clayey silt, friable             |       |       |
| 9801  | Layer |         | 2.2       |           | Natural. Mid yellowish brown, silty clay, compact               |       |       |
| <b>Trench 99</b>  |       |         |           |           |   |       |       |
| General description   |       |         |           |           | Orientation   |       | N-S   |
| Trench consists of a ploughsoil overlying a subsoil and a natural of silty clay. Trench contains one ditch and two natural features |       |         |           |           | Length (m)  |       | 30    |
|   |       |         |           |           | Width (m)   |       | 2.2   |
|   |       |         |           |           | Avg. depth (m)  |       | 0.56  |
| Context No.   | Type  | Fill Of | Width (m) | Depth (m) | Description   | Finds | Date  |
| 9900  | Layer |         | 2.2       | 0.42      | Ploughsoil. Mid greyish brown, clayey silt, moderately compact. |       |       |
| 9901  | Layer |         | 2.2       | 0.14      | Subsoil. Light greyish brown, clayey silt, firm.                |       |       |
| 9902  | Layer |         | 2.2       |           | Natural. Mid orangish brown, silty clay, firm.                  |       |       |
| 9903  | Cut   |         | 2.2       | 0.27      | Ditch. Possible ditch, at limit of excavation.                  |       |       |
| 9904  | Fill  | 9903    | 2.2       | 0.27      | Secondary Fill. Mid reddish grey, silty clay, compact           |       |       |

| 9905   | Cut   |         | 0.5       | 0.12      | Natural Feature.<br>Dark brownish grey,<br>silty clay, firm. |       |       |
|--|-------|---------|-----------|-----------|--|-------|-------|
| 9906   | Cut   |         | 0.5       | 0.16      | Natural Feature.<br>Dark brownish grey,<br>silty clay, firm. |       |       |
| <b>Trench 100</b>  |       |         |           |           |  |       |       |
| General description  |       |         |           |           | Orientation  |       | E-W   |
| Trench consists of ploughsoil overlying a subsoil and a natural of silty clay. Trench devoid of archaeology. |       |         |           |           | Length (m)   |       | 30    |
|  |       |         |           |           | Width (m)  |       | 2.2   |
|  |       |         |           |           | Avg. depth (m)   |       | 0.45  |
| Context No.  | Type  | Fill Of | Width (m) | Depth (m) | Description  | Finds | Date  |
| 10000  | Layer |         | 2.2       | 0.25      | Ploughsoil. Loose, dark brownish grey, clayey silt.          |       |       |
| 10001  | Layer |         | 2.2       | 0.2       | Subsoil. Compact, mid orangish brown, sandy clay.            |       |       |
| 10002  | Layer |         | 2.2       |           | Natural. Compact, mid greyish brown, silty clay.             |       |       |
| <b>Trench 101</b>  |       |         |           |           |  |       |       |
| General description  |       |         |           |           | Orientation  |       | NE-SW |
| Trench consists of a ploughsoil overlying a natural of silty clay. Trench devoid of archaeology              |       |         |           |           | Length (m)   |       | 30    |
|  |       |         |           |           | Width (m)  |       | 2.2   |
|  |       |         |           |           | Avg. depth (m)   |       | 0.42  |
| Context No.  | Type  | Fill Of | Width (m) | Depth (m) | Description  | Finds | Date  |
| 10100  | Layer |         | 2.2       | 0.42      | Ploughsoil. Mid greyish brown, clayey silt, friable.         |       |       |
| 10101  | Layer |         | 2.2       |           | Natural. Mid yellowish brown, silty clay, compact            |       |       |
| <b>Trench 102</b>  |       |         |           |           |  |       |       |
| General description  |       |         |           |           | Orientation  |       | E-W   |
| Trench consists of a ploughsoil overlying a natural of silty clay. Trench devoid of archaeology              |       |         |           |           | Length (m)   |       | 30    |
|  |       |         |           |           | Width (m)  |       | 2.2   |
|  |       |         |           |           | Avg. depth (m)   |       | 0.39  |
| Context No.  | Type  | Fill Of | Width (m) | Depth (m) | Description  | Finds | Date  |
| 10200  | Layer |         | 2.2       | 0.39      | Ploughsoil. Mid greyish brown, clayey silt, friable          |       |       |
| 10201  | Layer |         | 2.2       |           | Natural. Mid yellowish brown, silty clay, compact            |       |       |
| <b>Trench 103</b>  |       |         |           |           |  |       |       |

| General description  |       |         |           |           |   | Orientation    | NW-SE |
|--|-------|---------|-----------|-----------|---|----------------|-------|
| Trench consists of a ploughsoil overlying a natural of silty clay.<br>Trench devoid of archaeology |       |         |           |           |   | Length (m)     | 30    |
|  |       |         |           |           |   | Width (m)      | 2.2   |
|  |       |         |           |           |   | Avg. depth (m) | 0.32  |
| Context No.  | Type  | Fill Of | Width (m) | Depth (m) | Description   | Finds          | Date  |
| 10300  | Layer |         | 2.2       | 0.34      | Ploughsoil. Mid greyish brown, clayey silt, friable |                |       |
| 10301  | Layer |         | 2.2       |           | Natural. Mid orange brown, silty clay, compact      |                |       |
| <b>Trench 104</b>  |       |         |           |           |   |                |       |
| General description  |       |         |           |           |   | Orientation    | E-W   |
| Trench consists of a ploughsoil overlying a natural of silty clay.<br>Trench devoid of archaeology |       |         |           |           |   | Length (m)     | 30    |
|  |       |         |           |           |   | Width (m)      | 2.2   |
|  |       |         |           |           |   | Avg. depth (m) | 0.4   |
| Context No.  | Type  | Fill Of | Width (m) | Depth (m) | Description   | Finds          | Date  |
| 10400  | Layer |         | 2.2       | 0.42      | Ploughsoil. Loose, mid brownish grey, clayey silt   |                |       |
| 10401  | Layer |         | 2.2       |           | Natural. Compact, mid greyish brown, silty clay     |                |       |
| <b>Trench 105</b>  |       |         |           |           |   |                |       |
| General description  |       |         |           |           |   | Orientation    | E-W   |
| Trench consists of a ploughsoil overlying a natural of silty clay.<br>Trench devoid of archaeology |       |         |           |           |   | Length (m)     | 30    |
|  |       |         |           |           |   | Width (m)      | 2.2   |
|  |       |         |           |           |   | Avg. depth (m) | 0.4   |
| Context No.  | Type  | Fill Of | Width (m) | Depth (m) | Description   | Finds          | Date  |
| 10500  | Layer |         | 2.2       | 0.43      | Ploughsoil. Loose, mid brownish grey clayey silt    |                |       |
| 10501  | Layer |         | 2.2       |           | Natural. Compact, mid yellowish brown, silty clay.  |                |       |
| <b>Trench 106</b>  |       |         |           |           |   |                |       |
| General description  |       |         |           |           |   | Orientation    | E-W   |
| Trench consists of a ploughsoil overlying a natural of silty clay.<br>Trench devoid of archaeology |       |         |           |           |   | Length (m)     | 30    |
|  |       |         |           |           |   | Width (m)      | 2.2   |
|  |       |         |           |           |   | Avg. depth (m) | 0.4   |
| Context No.  | Type  | Fill Of | Width (m) | Depth (m) | Description   | Finds          | Date  |
| 10600  | Layer |         | 2.2       | 0.4       | Ploughsoil. Loose, mid brownish grey, clayey silt.  |                |       |

|   |       |         |           |           |   |       |       |
|---|-------|---------|-----------|-----------|---|-------|-------|
| 10601   | Layer |         | 2.2       |           | Natural. Compact, mid greyish brown, silty clay     |       |       |
| <b>Trench 107</b>   |       |         |           |           |   |       |       |
| General description   |       |         |           |           | Orientation   |       | N-S   |
| Trench consists of a ploughsoil overlying a natural of silty clay.<br>Trench devoid of archaeology  |       |         |           |           | Length (m)  |       | 30    |
|   |       |         |           |           | Width (m)   |       | 2.2   |
|   |       |         |           |           | Avg. depth (m)                                      |       | 0.4   |
| Context No.   | Type  | Fill Of | Width (m) | Depth (m) | Description   | Finds | Date  |
| 10700   | Layer |         | 2.2       | 0.44      | Ploughsoil. Loose, mid brownish grey, clayey silt.  |       |       |
| 10701   | Layer |         | 2.2       |           | Natural. Compact, mid greyish brown, silty clay     |       |       |
| <b>Trench 108</b>   |       |         |           |           |   |       |       |
| General description   |       |         |           |           | Orientation   |       | E-W   |
| Trench consists of a ploughsoil overlying a natural of silty clay.<br>Trench devoid of archaeology  |       |         |           |           | Length (m)  |       | 30    |
|   |       |         |           |           | Width (m)   |       | 2.2   |
|   |       |         |           |           | Avg. depth (m)                                      |       | 0.41  |
| Context No.   | Type  | Fill Of | Width (m) | Depth (m) | Description   | Finds | Date  |
| 10800   | Layer |         | 2.2       | 0.41      | Ploughsoil. Mid greyish brown, clayey silt, friable |       |       |
| 10801   | Layer |         | 2.2       |           | Natural. Mid yellowish brown, silty clay, compact   |       |       |
| <b>Trench 109</b>   |       |         |           |           |   |       |       |
| General description   |       |         |           |           | Orientation   |       | NW-SE |
| Trench consists of a ploughsoil overlying a natural of silty clay.<br>Trench devoid of archaeology. |       |         |           |           | Length (m)  |       | 30    |
|   |       |         |           |           | Width (m)   |       | 2.2   |
|   |       |         |           |           | Avg. depth (m)                                      |       | 0.3   |
| Context No.   | Type  | Fill Of | Width (m) | Depth (m) | Description   | Finds | Date  |
| 10900   | Layer |         |           | 0.3       | Ploughsoil. Loose dark greyish brown, clayey silt.  |       |       |
| 10901   | Layer |         |           |           | Natural. Compact mid yellowish brown, silty clay.   |       |       |
| <b>Trench 110</b>   |       |         |           |           |   |       |       |
| General description   |       |         |           |           | Orientation   |       | NW-SE |
| Trench consists of a ploughsoil overlying a natural of silty clay.<br>Trench devoid of archaeology. |       |         |           |           | Length (m)  |       | 29    |
|   |       |         |           |           | Width (m)   |       | 2.2   |
|   |       |         |           |           | Avg. depth (m)                                      |       | 0.3   |
| Context No.   | Type  | Fill Of | Width (m) | Depth (m) | Description   | Finds | Date  |

| 11000   | Layer |         | 2.2       | 0.36      | Ploughsoil. Dark brownish grey, silty loam, friable |       |      |
|---|-------|---------|-----------|-----------|---|-------|------|
| 11001   | Layer |         | 2.2       |           | Natural. Light greyish brown, silty clay, firm      |       |      |
| <b>Trench 111</b>   |       |         |           |           |   |       |      |
| General description   |       |         |           |           | Orientation   |       | E-W  |
| Trench consists of a ploughsoil overlying a natural of silty clay. Trench devoid of archaeology.              |       |         |           |           | Length (m)  |       | 30   |
|   |       |         |           |           | Width (m)   |       | 2.2  |
|   |       |         |           |           | Avg. depth (m)                                      |       | 0.32 |
| Context No.   | Type  | Fill Of | Width (m) | Depth (m) | Description   | Finds | Date |
| 11100   | Layer |         | 2.2       | 0.3       | Ploughsoil. Dark brownish grey, silty loam, friable |       |      |
| 11101   | Layer |         | 2.2       |           | Natural. Mid greyish brown, silty clay, firm        |       |      |
| <b>Trench 112</b>   |       |         |           |           |   |       |      |
| General description   |       |         |           |           | Orientation   |       | N-S  |
| Trench consists of a ploughsoil overlying a natural of silty clay. Trench devoid of archaeology.              |       |         |           |           | Length (m)  |       | 26   |
|   |       |         |           |           | Width (m)   |       | 2.2  |
|   |       |         |           |           | Avg. depth (m)                                      |       | 0.36 |
| Context No.   | Type  | Fill Of | Width (m) | Depth (m) | Description   | Finds | Date |
| 11200   | Layer |         | 2.2       | 0.38      | Ploughsoil. Dark brownish grey, silty loam, friable |       |      |
| 11201   | Layer |         | 2.2       |           | Natural. Mid greyish brown, silty clay, firm        |       |      |
| <b>Trench 113</b>   |       |         |           |           |   |       |      |
| General description   |       |         |           |           | Orientation   |       | E-W  |
| Trench consists of a ploughsoil overlying a natural of silty clay. Trench devoid of archaeology.              |       |         |           |           | Length (m)  |       | 30   |
|   |       |         |           |           | Width (m)   |       | 2.2  |
|   |       |         |           |           | Avg. depth (m)                                      |       | 0.36 |
| Context No.   | Type  | Fill Of | Width (m) | Depth (m) | Description   | Finds | Date |
| 11300   | Layer |         | 2.2       | 0.35      | Ploughsoil. Dark brownish grey, silty clay, firm    |       |      |
| 11301   | Layer |         | 2.2       |           | Natural. Mid greyish brown, silty clay, firm        |       |      |
| <b>Trench 114</b>   |       |         |           |           |   |       |      |
| General description   |       |         |           |           | Orientation   |       | N-S  |
| Trench consists of a ploughsoil overlying a natural of silty clay. Trench consists of three natural features. |       |         |           |           | Length (m)  |       | 30   |
|   |       |         |           |           | Width (m)   |       | 2.2  |

|             |       |         |           |           |   | Avg. depth (m) | 0.3  |
|-------------|-------|---------|-----------|-----------|---|----------------|------|
| Context No. | Type  | Fill Of | Width (m) | Depth (m) | Description   | Finds          | Date |
| 11400       | Layer |         | 2.2       | 0.3       | Ploughsoil. Loose, dark brownish grey, clayey silt.       |                |      |
| 11401       | Layer |         | 2.2       |           | Natural. Compact, mid orangish brown, silty clay.         |                |      |
| 11402       | Cut   |         | 0.35      |           | Natural Feature. Compact, mid greenish brown, silty clay. |                |      |
| 11403       | Cut   |         | 1.1       |           | Natural Feature. Compact, dark greyish brown, silty clay. |                |      |
| 11404       | Cut   |         | 1.4       |           | Natural Feature. Compact, mid greenish brown, silty clay. |                |      |

#### Trench 115

| General description  | Orientation    | E-W |
|--|----------------|-----|
| Trench consists of a ploughsoil overlying a natural of silty clay. Trench contains one potential posthole and one natural feature. | Length (m)     | 30  |
|  | Width (m)      | 2.2 |
|  | Avg. depth (m) | 0.3 |

| Context No. | Type  | Fill Of | Width (m) | Depth (m) | Description   | Finds | Date |
|-------------|-------|---------|-----------|-----------|---|-------|------|
| 11500       | Layer |         | 2.2       | 0.3       | Ploughsoil. Loose, dark brownish grey, clayey silt.                       |       |      |
| 11501       | Layer |         | 2.2       |           | Natural. Compact, mid orangish brown, silty clay.                         |       |      |
| 11502       | Cut   |         | 0.28      | 0.08      | Posthole  |       |      |
| 11503       | Fill  |         | 0.28      | 0.12      | Secondary Fill. Compact, mid greyish brown, silty clay                    |       |      |
| 11504       | Cut   |         | 2.2       |           | Natural Feature. Compact, mid orange brown with bands of grey, silty clay |       |      |

#### Trench 116

| General description  | Orientation    | E-W  |
|--|----------------|------|
| Trench consists of a ploughsoil overlying a subsoil and a natural of silty clay. Trench devoid of archaeology. | Length (m)     | 30   |
|  | Width (m)      | 2.2  |
|  | Avg. depth (m) | 0.38 |

| Context No. | Type | Fill Of | Width (m) | Depth (m) | Description | Finds | Date |
|-------------|------|---------|-----------|-----------|-------------|-------|------|
|-------------|------|---------|-----------|-----------|-------------|-------|------|

|       |       |  |  |      |  |  |  |
|-------|-------|--|--|------|--|--|--|
| 11600 | Layer |  |  | 0.3  | Ploughsoil. Loose dark greyish brown, clayey silt. |  |  |
| 11601 | Layer |  |  | 0.08 | Subsoil. Compact mid orangish brown silty clay.    |  |  |
| 11602 | Layer |  |  |      | Natural. Compact mid orangish brown clay.          |  |  |

#### Trench 117

|  |  |  |  |  |                |      |
|--|--|--|--|--|----------------|------|
| General description  |  |  |  |  | Orientation    | N-S  |
| Trench consists of a ploughsoil overlying a subsoil and a natural of silty clay. Trench devoid of archaeology. |  |  |  |  | Length (m)     | 30   |
|  |  |  |  |  | Width (m)      | 2.2  |
|  |  |  |  |  | Avg. depth (m) | 0.55 |

| Context No. | Type  | Fill Of | Width (m) | Depth (m) | Description  | Finds | Date |
|-------------|-------|---------|-----------|-----------|--|-------|------|
| 11700       | Layer |         |           | 0.3       | Ploughsoil. Loose dark greyish brown, clayey silt. |       |      |
| 11701       | Layer |         |           | 0.25      | Subsoil. Compact mid orangish brown silty clay.    |       |      |
| 11702       | Layer |         |           |           | Natural. Compact mid orangish clay.                |       |      |

#### Trench 118

|   |  |  |  |  |                |     |
|---|--|--|--|--|----------------|-----|
| General description   |  |  |  |  | Orientation    | E-W |
| Trench consists of a ploughsoil overlying a natural of silty clay. Trench contains one natural feature. |  |  |  |  | Length (m)     | 30  |
|   |  |  |  |  | Width (m)      | 2.2 |
|   |  |  |  |  | Avg. depth (m) | 0.3 |

| Context No. | Type  | Fill Of | Width (m) | Depth (m) | Description  | Finds | Date |
|-------------|-------|---------|-----------|-----------|--|-------|------|
| 11800       | Layer |         | 2.2       | 0.3       | Ploughsoil. Loose, dark brownish grey, clayey silt.      |       |      |
| 11801       | Layer |         | 2.2       |           | Natural. Compact, mid greyish brown, silty clay          |       |      |
| 11802       | Cut   |         | 1.1       |           | Natural Feature. Compact, mid greyish brown, silty clay. |       |      |

#### Trench 119

|  |  |  |  |  |                |      |
|--|--|--|--|--|----------------|------|
| General description  |  |  |  |  | Orientation    | E-W  |
| Trench consists of a ploughsoil overlying a natural of silty clay. Trench devoid of archaeology. |  |  |  |  | Length (m)     | 30   |
|  |  |  |  |  | Width (m)      | 2.2  |
|  |  |  |  |  | Avg. depth (m) | 0.35 |

| Context No. | Type  | Fill Of | Width (m) | Depth (m) | Description  | Finds | Date |
|-------------|-------|---------|-----------|-----------|--|-------|------|
| 11900       | Layer |         |           | 0.35      | Ploughsoil. Loose dark greyish brown, clayey silt. |       |      |



| 11901  | Layer |         |           |           | Natural. Compact mid orangish brown clay.             |                         |                |
|--|-------|---------|-----------|-----------|---|-------------------------|----------------|
| <b>Trench 120</b>  |       |         |           |           |   |                         |                |
| General description  |       |         |           |           | Orientation   | NE-SW                   |                |
| Trench consists of a ploughsoil overlying a natural of silty clay.<br>Trench contains one ditch.   |       |         |           |           | Length (m)  | 30                      |                |
|  |       |         |           |           | Width (m)   | 2.2                     |                |
|  |       |         |           |           | Avg. depth (m)  | 0.3                     |                |
| Context No.  | Type  | Fill Of | Width (m) | Depth (m) | Description   | Finds                   | Date           |
| 12000  | Layer |         | 2.2       | 0.3       | Ploughsoil. Loose, dark brownish grey, clayey silt.   |                         |                |
| 12001  | Layer |         | 2.2       |           | Natural. Compact, mid greyish brown, silty clay.      |                         |                |
| 12002  | Cut   |         | 1.6       | 0.66      | Ditch   |                         |                |
| 12003  | Fill  | 12002   | 1.6       | 0.3       | Primary Fill. Dark greyish brown, silty clay. compact | Pot, CBM, animal bone   | AD 1000 –1225? |
| 12004  | Fill  |         | 1.6       | 0.36      | Secondary Fill. Dark orangish brown, silty clay, firm | Pot, animal bone, shell | AD 1200 –1400? |
| <b>Trench 121</b>  |       |         |           |           |   |                         |                |
| General description  |       |         |           |           | Orientation   | E-W                     |                |
| Trench consists of a ploughsoil overlying a natural of silty clay.<br>Trench devoid of archaeology |       |         |           |           | Length (m)  | 30                      |                |
|  |       |         |           |           | Width (m)   | 2.2                     |                |
|  |       |         |           |           | Avg. depth (m)  | 0.25                    |                |
| Context No.  | Type  | Fill Of | Width (m) | Depth (m) | Description   | Finds                   | Date           |
| 12100  | Layer |         | 2.2       | 0.25      | Ploughsoil. Loose, dark brownish grey, clayey silt.   |                         |                |
| 12101  | Layer |         | 2.2       |           | Natural. Compact, mid greyish brown, silty clay.      |                         |                |
| <b>Trench 122</b>  |       |         |           |           |   |                         |                |
| General description  |       |         |           |           | Orientation   | N-S                     |                |
| Trench consists of a ploughsoil overlying a natural of silty clay.<br>Trench devoid of archaeology |       |         |           |           | Length (m)  | 30                      |                |
|  |       |         |           |           | Width (m)   | 2.2                     |                |
|  |       |         |           |           | Avg. depth (m)  | 0.25                    |                |
| Context No.  | Type  | Fill Of | Width (m) | Depth (m) | Description   | Finds                   | Date           |
| 12200  | Layer |         | 2.2       | 0.25      | Ploughsoil. Loose, dark brownish grey, clayey silt.   |                         |                |
| 12201  | Layer |         | 2.2       |           | Natural. Compact, mid greyish brown, silty clay.      |                         |                |

| <b>Trench 123</b>   |       |         |           |           |  |       |      |
|---|-------|---------|-----------|-----------|--|-------|------|
| General description   |       |         |           |           | Orientation  |       | E-W  |
| Trench consists of a ploughsoil overlying a natural of silty clay.<br>Trench devoid of archaeology              |       |         |           |           | Length (m)   |       | 30   |
|   |       |         |           |           | Width (m)  |       | 2.2  |
|   |       |         |           |           | Avg. depth (m)                                       |       | 0.25 |
| Context No.   | Type  | Fill Of | Width (m) | Depth (m) | Description  | Finds | Date |
| 12300   | Layer |         | 2.2       | 0.25      | Ploughsoil. Loose, dark brownish grey, clayey silt.  |       |      |
| 12301   | Layer |         | 2.2       |           | Natural. Compact, mid greyish brown, silty clay.     |       |      |
| <b>Trench 124</b>   |       |         |           |           |  |       |      |
| General description   |       |         |           |           | Orientation  |       | E-W  |
| Trench consists of a ploughsoil overlying a natural of silty clay.<br>Trench contains one ditch.                |       |         |           |           | Length (m)   |       | 30   |
|   |       |         |           |           | Width (m)  |       | 2.2  |
|   |       |         |           |           | Avg. depth (m)                                       |       | 0.3  |
| Context No.   | Type  | Fill Of | Width (m) | Depth (m) | Description  | Finds | Date |
| 12400   | Layer |         | 2.2       | 0.3       | Ploughsoil. Loose, dark brownish grey, clayey silt.  |       |      |
| 12401   | Layer |         | 2.2       |           | Natural. Compact, mid greyish brown, silty clay.     |       |      |
| 12402   | Cut   |         | 0.54      | 0.27      | Ditch  |       |      |
| 12403   | Fill  | 12402   | 0.54      | 0.27      | Primary Fill. Mid brownish grey, silty clay, compact |       |      |
| <b>Trench 125</b>   |       |         |           |           |  |       |      |
| General description   |       |         |           |           | Orientation  |       | N-S  |
| Trench consists of a ploughsoil overlying a natural of silty clay.<br>Trench devoid of archaeology              |       |         |           |           | Length (m)   |       | 30   |
|   |       |         |           |           | Width (m)  |       | 2.2  |
|   |       |         |           |           | Avg. depth (m)                                       |       | 0.3  |
| Context No.   | Type  | Fill Of | Width (m) | Depth (m) | Description  | Finds | Date |
| 12500   | Layer |         | 2.2       | 0.3       | Ploughsoil. Loose, dark brownish grey, clayey silt.  |       |      |
| 12501   | Layer |         | 2.2       |           | Natural. Compact, mid greyish brown, silty clay.     |       |      |
| <b>Trench 126</b>   |       |         |           |           |  |       |      |
| General description   |       |         |           |           | Orientation  |       | E-W  |
| Trench consists of ploughsoil overlying a natural of silty clay.<br>Trench contains one ditch and one posthole. |       |         |           |           | Length (m)   |       | 30   |
|   |       |         |           |           | Width (m)  |       | 2.2  |
|   |       |         |           |           | Avg. depth (m)                                       |       | 0.25 |

| Context No. | Type  | Fill Of | Width (m) | Depth (m) | Description  | Finds            | Date |
|-------------|-------|---------|-----------|-----------|--|------------------|------|
| 12600       | Layer |         | 2.2       | 0.25      | Ploughsoil. Loose. dark brownish grey, clayey silt.  |                  |      |
| 12601       | Layer |         | 2.2       |           | Natural. Compact, mid greyish brown, silty clay.     |                  |      |
| 12602       | Void  |         |           |           |  |                  |      |
| 12603       | Cut   |         | 0.5       | 0.2       | Ditch  |                  |      |
| 12604       | Fill  | 12603   | 0.5       | 0.2       | Secondary Fill. Mid greyish brown, silty clay, firm  | CBM, animal bone | PMed |
| 12605       | Cut   |         | 0.25      | 0.08      | Posthole   |                  |      |
| 12606       | Fill  | 12605   | 0.25      | 0.08      | Secondary Fill. Dark greyish brown, silty clay, firm |                  |      |

### Trench 127

|   |                |       |
|---|----------------|-------|
| General description   | Orientation    | NW-SE |
| Trench consists of a ploughsoil overlying a subsoil and a natural of silty clay. Trench contains one ditch. | Length (m)     | 30    |
|   | Width (m)      | 2.2   |
|   | Avg. depth (m) | 0.35  |

| Context No. | Type  | Fill Of | Width (m) | Depth (m) | Description   | Finds | Date |
|-------------|-------|---------|-----------|-----------|---|-------|------|
| 12700       | Layer |         | 2.2       | 0.25      | Ploughsoil. Loose, dark brownish grey, clayey silt.                   |       |      |
| 12701       | Layer |         | 2.2       | 0.1       | Subsoil. Compact, mid greyish brown, silty clay.                      |       |      |
| 12702       | Layer |         | 2.2       |           | Natural. Compact, mid greyish brown, silty clay.                      |       |      |
| 12703       | Cut   |         | 0.6       | 0.19      | Ditch   |       |      |
| 12704       | Fill  | 12703   | 0.6       | 0.19      | Secondary Fill. Mid greyish brown, silty clay, firm slightly plastic. |       |      |

### Trench 128

|   |                |       |
|---|----------------|-------|
| General description   | Orientation    | NE-SW |
| Trench consists of a ploughsoil overlying a subsoil and a natural of silty clay. Trench contains one pit and one natural feature. | Length (m)     | 30    |
|   | Width (m)      | 2.2   |
|   | Avg. depth (m) | 0.38  |

| Context No. | Type  | Fill Of | Width (m) | Depth (m) | Description   | Finds | Date |
|-------------|-------|---------|-----------|-----------|---|-------|------|
| 12800       | Layer |         | 2.2       | 0.25      | Ploughsoil. Loose, dark brownish grey, clayey silt. |       |      |
| 12801       | Layer |         | 2.2       | 0.13      | Subsoil. Compact, mid greyish brown, silty clay.    |       |      |

|       |       |       |      |      |   |          |               |
|-------|-------|-------|------|------|---|----------|---------------|
| 12802 | Layer |       | 2.2  |      | Natural. Compact, mid greyish brown, silty clay.          |          |               |
| 12803 | Cut   |       | 0.38 | 0.13 | Natural Feature. Compact, dark brownish grey, silty clay. |          |               |
| 12804 | Cut   |       | 1.6  | 0.22 | Pit   |          |               |
| 12805 | Fill  | 12804 | 1.6  | 0.22 | Secondary Fill. Mid brownish grey, silty clay, firm       | Pot, CBM | 10–13C?, PMed |

### Trench 129

| General description   |       |         |           |           | Orientation   | E-W   |      |
|---|-------|---------|-----------|-----------|---|-------|------|
| Trench consists of a ploughsoil overlying a natural of silty clay. Trench devoid of archaeology |       |         |           |           | Length (m)  | 30    |      |
|   |       |         |           |           | Width (m)   | 2.2   |      |
|   |       |         |           |           | Avg. depth (m)                                      | 0.35  |      |
| Context No.   | Type  | Fill Of | Width (m) | Depth (m) | Description   | Finds | Date |
| 12900   | Layer |         | 2.2       | 0.25      | Ploughsoil. Loose, dark brownish grey, clayey silt. |       |      |
| 12901   | Layer |         | 2.2       | 0.1       | Subsoil. Compact, mid greyish brown, silty clay.    |       |      |
| 12902   | Layer |         | 2.2       |           | Natural. Compact, mid greyish brown, silty clay.    |       |      |

### Trench 130

| General description   |       |         |           |           | Orientation   | E-W   |      |
|---|-------|---------|-----------|-----------|---|-------|------|
| Trench consists of a ploughsoil overlying a subsoil and a natural of silty clay. Trench contains three pits and a ditch |       |         |           |           | Length (m)  | 30    |      |
|   |       |         |           |           | Width (m)   | 2.2   |      |
|   |       |         |           |           | Avg. depth (m)  | 0.45  |      |
| Context No.   | Type  | Fill Of | Width (m) | Depth (m) | Description   | Finds | Date |
| 13000   | Layer |         | 2.2       | 0.3       | Ploughsoil. Loose, dark brownish grey, clayey silt.   |       |      |
| 13001   | Layer |         | 2.2       | 0.15      | Subsoil. Compact, mid greyish brown, silty clay.      |       |      |
| 13002   | Layer |         | 2.2       |           | Natural. Compact, mid orangish brown, silty clay.     |       |      |
| 13003   | Cut   |         | 1.45      | 0.18      | Pit   |       |      |
| 13004   | Fill  | 13003   | 1.45      | 0.18      | Secondary Fill. Light brownish grey, silty clay, firm |       |      |
| 13005   | Cut   |         | 0.6       | 0.22      | Ditch   |       |      |
| 13006   | Fill  | 13005   | 0.6       | 0.22      | Secondary Fill. light brownish grey, silty clay, firm |       |      |
| 13007   | Cut   |         | 1.2       | 0.24      | Pit   |       |      |

|       |      |       |     |      |   |  |  |
|-------|------|-------|-----|------|---|--|--|
| 13008 | Fill | 13007 | 1.2 | 0.24 | Secondary Fill. light brownish grey, silty clay, firm.  |  |  |
| 13009 | Cut  |       | 1.3 | 0.17 | Pit   |  |  |
| 13010 | Fill | 13009 | 1.3 | 0.17 | Secondary Fill. light greyish brown, silty clay, firm.  |  |  |
| 13011 | Cut  |       | 1   | 0.1  | Modern. Light brownish grey, silty clay, firm. Truncated by modern field drains. Contained finds. |  |  |
| 13012 | Void |       |     |      |   |  |  |

### Trench 131

| General description  |       |         |           |           | Orientation  | NE-SW |      |
|--|-------|---------|-----------|-----------|--|-------|------|
| Trench consists of a ploughsoil overlying a subsoil and a natural of silty clay. Trench contains one pit and two natural features. |       |         |           |           | Length (m)   | 30    |      |
|  |       |         |           |           | Width (m)  | 2.2   |      |
|  |       |         |           |           | Avg. depth (m)   | 0.4   |      |
| Context No.  | Type  | Fill Of | Width (m) | Depth (m) | Description  | Finds | Date |
| 13100  | Layer |         | 2.2       | 0.25      | Ploughsoil. Loose, dark brownish grey, clayey silt.      |       |      |
| 13101  | Layer |         | 2.2       | 0.15      | Subsoil. Compact, mid orangish brown, silty clay.        |       |      |
| 13102  | Layer |         | 2.2       |           | Natural. Compact, mid orangish brown, silty clay.        |       |      |
| 13103  | Cut   |         | 0.8       | 0.08      | Natural Feature. Compact, mid orangish brown, silty clay |       |      |
| 13104  | Cut   |         | 0.9       | 0.02      | Natural Feature. Compact, mid orange brown, silty clay   |       |      |
| 13105  | Cut   |         | 0.94      | 0.05      | Pit  |       |      |
| 13106  | Fill  | 13105   | 0.95      | 0.08      | Secondary Fill. Compact, mid orange brown, silty clay    |       |      |

### Trench 132

| General description   |       |         |           |           | Orientation   | NW-SE |      |
|---|-------|---------|-----------|-----------|---|-------|------|
| Trench consists of a ploughsoil overlying a subsoil and a natural of silty clay. Trench contains one posthole and four natural features |       |         |           |           | Length (m)  | 30    |      |
|   |       |         |           |           | Width (m)   | 2.2   |      |
|   |       |         |           |           | Avg. depth (m)                                      | 0.4   |      |
| Context No.   | Type  | Fill Of | Width (m) | Depth (m) | Description   | Finds | Date |
| 13200   | Layer |         | 2.2       | 0.25      | Ploughsoil. Loose, dark brownish grey, clayey silt. |       |      |

|       |       |       |      |      |  |  |  |
|-------|-------|-------|------|------|--|--|--|
| 13201 | Layer |       | 2.2  | 0.15 | Subsoil. Compact, light orangish brown, silty clay.          |  |  |
| 13202 | Layer |       | 2.2  |      | Natural. Compact, light orangish brown, silty clay.          |  |  |
| 13203 | Cut   |       | 0.24 | 0.1  | Posthole. Posthole or small pit with burnt clay and charcoal |  |  |
| 13204 | Fill  | 13203 | 0.2  | 0.02 | Primary Fill. Dark blackish brown, silty clay, firm          |  |  |
| 13205 | Fill  | 13203 | 0.24 | 0.08 | Primary Fill. Mid brownish orange, silty clay, firm.         |  |  |
| 13206 | Cut   |       | 0.5  | 0.25 | Natural Feature. Mid greyish brown, silty clay, firm         |  |  |
| 13207 | Cut   |       | 2    | 0.5  | Natural Feature. Mid blackish brown, silty clay, compact     |  |  |
| 13208 | Cut   |       | 0.3  | 0.15 | Natural Feature. Mid greyish brown, silty clay, firm.        |  |  |
| 13209 | Cut   |       | 0.2  | 0.1  | Natural Feature. Mid blackish brown, silty clay, compact     |  |  |

### Trench 133

| General description  |       |         |           |           | Orientation   | E-W             |        |
|--|-------|---------|-----------|-----------|---|-----------------|--------|
| Trench consists of a ploughsoil overlying a subsoil and a natural of silty clay. Trench contains 4 pits. |       |         |           |           | Length (m)  | 30              |        |
|  |       |         |           |           | Width (m)   | 2.2             |        |
|  |       |         |           |           | Avg. depth (m)  | 0.4             |        |
| Context No.  | Type  | Fill Of | Width (m) | Depth (m) | Description   | Finds           | Date   |
| 13300  | Layer |         | 2.2       | 0.25      | Ploughsoil. Loose, dark brownish grey, clayey silt.     |                 |        |
| 13301  | Layer |         | 2.2       | 0.15      | Subsoil. Compact, mid orangish brown, silty clay.       |                 |        |
| 13302  | Layer |         | 2.2       |           | Natural. Compact, light orangish brown, silty clay.     |                 |        |
| 13303  | Cut   |         | 0.8       | 0.12      | Ditch. Possibly a pit                                   |                 |        |
| 13304  | Fill  | 13303   | 0.8       | 0.12      | Secondary Fill. Dark brownish grey, friable, silty clay | Pot, fired clay | E/MIA? |
| 13305  | Cut   |         | 0.9       | 0.18      | Pit. Possibly natural                                   |                 |        |
| 13306  | Fill  | 13305   | 0.9       | 0.18      | Secondary Fill. Mid brownish grey, silty clay, firm     | Animal bone     |        |
| 13307  | Cut   |         | 1.5       | 0.2       | Pit. Possibly a natural feature                         |                 |        |

| 13308  | Fill                | 13307   | 1.5       | 0.2       | Secondary Fill. Mid brownish grey, silty clay, firm                     |       |      |
|--|---------------------|---------|-----------|-----------|---|-------|------|
| <b>Trench 134</b>  |                     |         |           |           |   |       |      |
| General description  |                     |         |           |           | Orientation   | NW-SE |      |
| Trench consists of a ploughsoil overlying a subsoil and a natural of silty clay. Trench devoid of archaeology                              |                     |         |           |           | Length (m)  | 30    |      |
|  |                     |         |           |           | Width (m)   | 2.2   |      |
|  |                     |         |           |           | Avg. depth (m)  | 0.45  |      |
| Context No.  | Type                | Fill Of | Width (m) | Depth (m) | Description   | Finds | Date |
| 13400  | Layer               |         | 2.2       | 0.3       | Ploughsoil. Loose, dark brownish grey, clayey silt.                     |       |      |
| 13401  | Layer               |         | 2.2       | 0.15      | Subsoil. Compact, mid greyish brown, silty clay.                        |       |      |
| 13402  | Layer               |         | 2.2       |           | Natural. Compact, mid orangish brown, silty clay.                       |       |      |
| <b>Trench 135</b>  |                     |         |           |           |   |       |      |
| General description  |                     |         |           |           | Orientation   | N-S   |      |
| Trench consists of a ploughsoil overlying a subsoil and a natural of silty clay. Trench contains two linear ditches and 2 natural features |                     |         |           |           | Length (m)  | 30    |      |
|  |                     |         |           |           | Width (m)   | 2.2   |      |
|  |                     |         |           |           | Avg. depth (m)  | 0.5   |      |
| Context No.  | Type                | Fill Of | Width (m) | Depth (m) | Description   | Finds | Date |
| 13500  | Layer               |         | 2.2       | 0.35      | Ploughsoil. Loose, dark brownish grey, clayey silt.                     |       |      |
| 13501  | Layer               |         | 2.2       | 0.15      | Subsoil. Compact, mid greyish brown, silty clay                         |       |      |
| 13502  | Layer               |         |           |           | Natural. Light orangish brown, silty clay, compact.                     |       |      |
| 13503  | Unexcavated feature |         | 0.7       |           | Ditch. Mid greyish brown ,silty clay, firm                              |       |      |
| 13504  | Cut                 |         | 0.8       | 0.25      | Natural Feature. Dark greyish brown, silty clay, firm slightly plastic. |       |      |
| 13505  | Void                |         |           |           |   |       |      |
| 13506  | Cut                 |         | 1.3       | 0.1       | Natural Feature. Mid greyish brown, silty clay, firm                    |       |      |
| 13507  | Cut                 |         | 0.65      | 0.3       | Ditch   |       |      |
| 13508  | Fill                | 13507   | 0.65      | 0.3       | Secondary Fill. Mid greyish brown, silty clay, firm, slightly plastic   |       |      |
| <b>Trench 136</b>  |                     |         |           |           |   |       |      |

| General description  |       |         |           |           |  | Orientation    | NE-SW |
|--|-------|---------|-----------|-----------|--|----------------|-------|
| Trench consists of a ploughsoil overlying a subsoil and a natural of silty clay. Trench contains 3 natural features. |       |         |           |           |  | Length (m)     | 30    |
|  |       |         |           |           |  | Width (m)      | 2.2   |
|  |       |         |           |           |  | Avg. depth (m) | 0.45  |
| Context No.  | Type  | Fill Of | Width (m) | Depth (m) | Description  | Finds          | Date  |
| 13600  | Layer |         | 2.2       | 0.3       | Ploughsoil. Loose, dark brownish grey, clayey silt.    |                |       |
| 13601  | Layer |         | 2.2       | 0.15      | Subsoil. Compact, light greyish brown, silty clay      |                |       |
| 13602  | Layer |         | 2.2       |           | Natural. Compact, mid orangish brown, silty clay.      |                |       |
| 13603  | Cut   |         | 0.68      | 0.13      | Natural Feature. Dark greyish brown, silty clay, firm. |                |       |
| 13604  | Cut   |         | 0.9       | 0.24      | Natural Feature. Dark brownish grey, clayey silt, firm |                |       |
| 13605  | Cut   |         | 0.38      | 0.18      | Natural Feature. Dark brownish grey silty clay         |                |       |

### Trench 138

| General description   |       |         |           |           |  | Orientation    | NW-SE |
|---|-------|---------|-----------|-----------|--|----------------|-------|
| Trench consists of a ploughsoil overlying a subsoil and a natural of silty clay. Trench contains one ditch. |       |         |           |           |  | Length (m)     | 30    |
|   |       |         |           |           |  | Width (m)      | 2.2   |
|   |       |         |           |           |  | Avg. depth (m) | 0.7   |
| Context No.   | Type  | Fill Of | Width (m) | Depth (m) | Description  | Finds          | Date  |
| 13800   | Layer |         | 2.2       | 0.25      | Ploughsoil. Loose, dark brownish grey, clayey silt.        |                |       |
| 13801   | Void  |         |           |           |  |                |       |
| 13802   | Layer |         | 2.2       |           | Natural. Compact, dark greyish brown, clayey silt.         |                |       |
| 13803   | Layer |         | 2.2       | 0.32      | Subsoil. Mid greyish brown, silty clay, firm.              |                |       |
| 13804   | Cut   |         | 8.8       | 0.62      | Ditch. Modern ditch - section done into bulk. No finds     |                |       |
| 13805   | Fill  | 13804   | 6.6       | 0.13      | Primary Fill. Orangish grey, silty clay, hard.             |                |       |
| 13806   | Fill  | 13804   | 4.62      | 0.62      | Deliberate Backfill. Dark greyish brown, silty clay, hard. |                |       |
| 13807   | Fill  | 13804   | 4.23      | 0.32      | Deliberate Backfill. dark greyish brown, silty clay, hard. |                |       |



| 13808   | Fill  | 13804   | 2         | 0.6       | Primary Fill. Light reddish brown, gravelly clay, hard  |       |       |
|---|-------|---------|-----------|-----------|---|-------|-------|
| <b>Trench 139</b>   |       |         |           |           |   |       |       |
| General description   |       |         |           |           | Orientation   |       | NE-SW |
| Trench consists of a ploughsoil overlying a natural of sandy clay. Trench devoid of archaeology.              |       |         |           |           | Length (m)  |       | 30    |
|   |       |         |           |           | Width (m)   |       | 2.2   |
|   |       |         |           |           | Avg. depth (m)  |       | 0.4   |
| Context No.   | Type  | Fill Of | Width (m) | Depth (m) | Description   | Finds | Date  |
| 13900   | Layer |         | 2.2       | 0.4       | Ploughsoil. Mid brownish grey, sandy silt, friable      |       |       |
| 13901   | Layer |         | 2.2       |           | Natural. Mid reddish brown, clayey sand, soft           |       |       |
| <b>Trench 140</b>   |       |         |           |           |   |       |       |
| General description   |       |         |           |           | Orientation   |       | NW-SE |
| Trench consists of a ploughsoil overlying a natural of silty clay. Trench contains one ditch.                 |       |         |           |           | Length (m)  |       | 30    |
|   |       |         |           |           | Width (m)   |       | 2.2   |
|   |       |         |           |           | Avg. depth (m)  |       | 0.33  |
| Context No.   | Type  | Fill Of | Width (m) | Depth (m) | Description   | Finds | Date  |
| 14000   | Layer |         | 2.2       | 0.33      | Ploughsoil. Mid brownish grey, sandy silt, friable      |       |       |
| 14001   | Layer |         | 2.2       |           | Natural. Dark greyish brown, silty clay, firm           |       |       |
| 14002   | Cut   |         | 1.24      | 0.46      | Ditch   |       |       |
| 14003   | Fill  | 14002   | 1.24      | 0.35      | Secondary Fill. Compact, dark greyish brown, silty clay | CBM   | PMed? |
| <b>Trench 141</b>   |       |         |           |           |   |       |       |
| General description   |       |         |           |           | Orientation   |       | E-W   |
| Trench consists of a ploughsoil overlying a subsoil and a natural of silty clay. Trench devoid of archaeology |       |         |           |           | Length (m)  |       | 30    |
|   |       |         |           |           | Width (m)   |       | 2.2   |
|   |       |         |           |           | Avg. depth (m)  |       | 0.51  |
| Context No.   | Type  | Fill Of | Width (m) | Depth (m) | Description   | Finds | Date  |
| 14100   | Layer |         | 2.2       | 0.38      | Ploughsoil. Mid greyish brown, clayey silt, friable     |       |       |
| 14101   | Layer |         | 2.2       | 0.16      | Subsoil. Mid brownish orange, silty clay, firm          |       |       |
| 14102   | Layer |         | 2.2       |           | Natural. Mid orange brown, silty clay, compact.         |       |       |

| <b>Trench 142</b>   |       |         |           |           |   |       |       |
|---|-------|---------|-----------|-----------|---|-------|-------|
| General description   |       |         |           |           | Orientation   |       | NW-SE |
| Trench consists of a ploughsoil overlying a natural of clayey gravel. Trench devoid of archaeology.     |       |         |           |           | Length (m)  |       | 30    |
|   |       |         |           |           | Width (m)   |       | 2.2   |
|   |       |         |           |           | Avg. depth (m)  |       | 0.24  |
| Context No.   | Type  | Fill Of | Width (m) | Depth (m) | Description   | Finds | Date  |
| 14200   | Layer |         | 2.2       | 0.24      | Ploughsoil. Dark brownish grey, silty loam, friable                               |       |       |
| 14201   | Layer |         | 2.2       |           | Natural. Light yellowish brown, clayey gravel, firm                               |       |       |
| <b>Trench 143</b>   |       |         |           |           |   |       |       |
| General description   |       |         |           |           | Orientation   |       | E-W   |
| Trench consists of a ploughsoil overlying a natural of silty clay. Trench contains one natural feature. |       |         |           |           | Length (m)  |       | 30    |
|   |       |         |           |           | Width (m)   |       | 2.2   |
|   |       |         |           |           | Avg. depth (m)  |       | 0.26  |
| Context No.   | Type  | Fill Of | Width (m) | Depth (m) | Description   | Finds | Date  |
| 14300   | Layer |         | 2.2       | 0.26      | Ploughsoil. Dark brownish grey, silty loam, friable                               |       |       |
| 14301   | Layer |         | 2.2       |           | Natural. Light yellowish brown, silty clay, firm                                  |       |       |
| 14302   | Cut   |         | 1.08      | 0.05      | Natural Feature. Dark blackish brown clayey silt. Frequent sub angular inclusions |       |       |
| <b>Trench 144</b>   |       |         |           |           |   |       |       |
| General description   |       |         |           |           | Orientation   |       | N-S   |
| Trench consists of a ploughsoil overlying a natural of silty clay. Trench contains one natural feature. |       |         |           |           | Length (m)  |       | 30    |
|   |       |         |           |           | Width (m)   |       | 2     |
|   |       |         |           |           | Avg. depth (m)  |       | 0.3   |
| Context No.   | Type  | Fill Of | Width (m) | Depth (m) | Description   | Finds | Date  |
| 14400   | Layer |         | 2         | 0.32      | Ploughsoil. Dark brownish grey, silty loam, friable                               |       |       |
| 14401   | Layer |         | 2         |           | Natural. Light greyish brown, silty clay with frequent gravel, firm               |       |       |
| 14402   | Cut   |         | 1.29      | 0.05      | Natural Feature. Dark blackish brown silty clay fill. Frequent rounded inclusions |       |       |
| <b>Trench 145</b>   |       |         |           |           |   |       |       |

| General description   |       |         |           |           |   | Orientation    | N-S  |
|---|-------|---------|-----------|-----------|---|----------------|------|
| Trench consists of a ploughsoil overlying a natural of silty clay.<br>Trench devoid of archaeology. |       |         |           |           |   | Length (m)     | 30   |
|   |       |         |           |           |   | Width (m)      | 2    |
|   |       |         |           |           |   | Avg. depth (m) | 0.32 |
| Context No.   | Type  | Fill Of | Width (m) | Depth (m) | Description   | Finds          | Date |
| 14500   | Layer |         | 2         | 0.3       | Ploughsoil. Dark brownish grey, silty loam, friable                   |                |      |
| 14501   | Layer |         | 2         |           | Natural. Light greyish brown, silty clay with frequent gravel, firm.  |                |      |
| <b>Trench 146</b>   |       |         |           |           |   |                |      |
| General description   |       |         |           |           |   | Orientation    | E-W  |
| Trench consists of a ploughsoil overlying a natural of silty clay.<br>Trench devoid of archaeology. |       |         |           |           |   | Length (m)     | 30   |
|   |       |         |           |           |   | Width (m)      | 2    |
|   |       |         |           |           |   | Avg. depth (m) | 0.28 |
| Context No.   | Type  | Fill Of | Width (m) | Depth (m) | Description   | Finds          | Date |
| 14600   | Layer |         | 2         | 0.28      | Ploughsoil. Dark brownish grey, silty loam, friable                   |                |      |
| 14601   | Layer |         | 2         |           | Natural. Light yellowish brown, silty clay with frequent gravel, firm |                |      |
| <b>Trench 147</b>   |       |         |           |           |   |                |      |
| General description   |       |         |           |           |   | Orientation    | N-S  |
| Trench consists of a ploughsoil overlying a natural of sandy gravel. Trench devoid of archaeology.  |       |         |           |           |   | Length (m)     | 30   |
|   |       |         |           |           |   | Width (m)      | 2    |
|   |       |         |           |           |   | Avg. depth (m) | 0.26 |
| Context No.   | Type  | Fill Of | Width (m) | Depth (m) | Description   | Finds          | Date |
| 14700   | Layer |         | 2         | 0.26      | Ploughsoil. Dark brownish grey, silty loam, friable                   |                |      |
| 14701   | Layer |         | 2         |           | Natural. Light greyish brown, clayey gravel, firm                     |                |      |
| <b>Trench 148</b>   |       |         |           |           |   |                |      |
| General description   |       |         |           |           |   | Orientation    | E-W  |
| Trench consists of a ploughsoil overlying a natural of silty clay.<br>Trench devoid of archaeology. |       |         |           |           |   | Length (m)     | 30   |
|   |       |         |           |           |   | Width (m)      | 2    |
|   |       |         |           |           |   | Avg. depth (m) | 0.24 |
| Context No.   | Type  | Fill Of | Width (m) | Depth (m) | Description   | Finds          | Date |
| 14800   | Layer |         | 2         | 0.24      | Ploughsoil. Dark brownish grey, silty loam, friable                   |                |      |

|  |       |         |           |           |  |       |       |
|--|-------|---------|-----------|-----------|--|-------|-------|
| 14801  | Layer |         | 2         |           | Subsoil. Light greyish brown, silty clay, firm   |       |       |
| <b>Trench 149</b>  |       |         |           |           |  |       |       |
| General description  |       |         |           |           | Orientation  |       | N-S   |
| Trench consists of a ploughsoil overlying a natural of silty clay. Trench devoid of archaeology.                   |       |         |           |           | Length (m)   |       | 30    |
|  |       |         |           |           | Width (m)  |       | 2     |
|  |       |         |           |           | Avg. depth (m)   |       | 0.3   |
| Context No.  | Type  | Fill Of | Width (m) | Depth (m) | Description  | Finds | Date  |
| 14900  | Layer |         | 2         | 0.3       | Ploughsoil. Dark brownish grey, silty loam, friable  |       |       |
| 14901  | Layer |         | 2         |           | Natural. Light greyish brown, silty clay, firm   |       |       |
| <b>Trench 150</b>  |       |         |           |           |  |       |       |
| General description  |       |         |           |           | Orientation  |       | NW-SE |
| Trench consists of a ploughsoil and subsoil overlying natural geology of silty clay. Trench devoid of archaeology. |       |         |           |           | Length (m)   |       | 30    |
|  |       |         |           |           | Width (m)  |       | 2     |
|  |       |         |           |           | Avg. depth (m)   |       | 0.32  |
| Context No.  | Type  | Fill Of | Width (m) | Depth (m) | Description  | Finds | Date  |
| 15000  | Layer |         | 2         | 0.32      | Ploughsoil. Dark brownish grey, silty loam, friable  |       |       |
| 15001  | Layer |         | 2         |           | Natural. Light greyish brown, silty clay, firm   |       |       |
| 15002  | Layer |         | 2         |           | Subsoil. Mid greyish brown, silty clay with frequent gravel, firm. Surviving at lower end of trench. |       |       |
| <b>Trench 151</b>  |       |         |           |           |  |       |       |
| General description  |       |         |           |           | Orientation  |       | NE-SW |
| Trench consists of a ploughsoil overlying a natural of silty clay. Trench devoid of archaeology.                   |       |         |           |           | Length (m)   |       | 30    |
|  |       |         |           |           | Width (m)  |       | 2     |
|  |       |         |           |           | Avg. depth (m)   |       | 0.24  |
| Context No.  | Type  | Fill Of | Width (m) | Depth (m) | Description  | Finds | Date  |
| 15100  | Layer |         | 2         | 0.26      | Ploughsoil. Dark brownish grey, silty loam, friable  |       |       |
| 15101  | Layer |         | 2         |           | Natural. Light greyish brown, silty clay, firm.  |       |       |
| <b>Trench 152</b>  |       |         |           |           |  |       |       |
| General description  |       |         |           |           | Orientation  |       | NW-SE |

| Trench consists of a ploughsoil overlying a natural of silty clay.<br>Trench devoid of archaeology. |       |         |           |           |   | Length (m)     | 30      |
|---|-------|---------|-----------|-----------|---|----------------|---------|
|   |       |         |           |           |   | Width (m)      | 2       |
|   |       |         |           |           |   | Avg. depth (m) | 0.2     |
| Context No.   | Type  | Fill Of | Width (m) | Depth (m) | Description   | Finds          | Date    |
| 15200   | Layer |         | 2         | 0.2       | Ploughsoil. Dark brownish grey, silty loam, friable |                |         |
| 15201   | Layer |         | 2         |           | Natural. Light greyish brown, silty clay, firm      |                |         |
| <b>Trench 153</b>   |       |         |           |           |   |                |         |
| General description   |       |         |           |           |   | Orientation    | NW-SE   |
| Trench consists of a ploughsoil overlying a natural of silty clay.<br>Trench devoid of archaeology. |       |         |           |           |   | Length (m)     | 30      |
|   |       |         |           |           |   | Width (m)      | 2       |
|   |       |         |           |           |   | Avg. depth (m) | 0.25    |
| Context No.   | Type  | Fill Of | Width (m) | Depth (m) | Description   | Finds          | Date    |
| 15300   | Layer |         | 2         | 0.25      | Ploughsoil. Dark brownish grey, silty loam, friable |                |         |
| 15301   | Layer |         | 2         | 0.25      | Natural. Light greyish brown, silty clay, firm      |                |         |
| <b>Trench 154</b>   |       |         |           |           |   |                |         |
| General description   |       |         |           |           |   | Orientation    | NW-SE   |
| Trench consists of a ploughsoil overlying a natural of silty clay.<br>Trench devoid of archaeology. |       |         |           |           |   | Length (m)     | 30      |
|   |       |         |           |           |   | Width (m)      | 2       |
|   |       |         |           |           |   | Avg. depth (m) | 0.3     |
| Context No.   | Type  | Fill Of | Width (m) | Depth (m) | Description   | Finds          | Date    |
| 15400   | Layer |         | 2         | 0.3       | Ploughsoil. Dark brownish grey, silty loam, friable |                |         |
| 15401   | Layer |         | 2         |           | Natural. Light greyish brown, silty clay, firm      |                |         |
| <b>Trench 155</b>   |       |         |           |           |   |                |         |
| General description   |       |         |           |           |   | Orientation    | WNW-ESE |
| Trench consists of a ploughsoil overlying a natural of silty clay.<br>Trench devoid of archaeology. |       |         |           |           |   | Length (m)     | 30      |
|   |       |         |           |           |   | Width (m)      | 2       |
|   |       |         |           |           |   | Avg. depth (m) | 0.2     |
| Context No.   | Type  | Fill Of | Width (m) | Depth (m) | Description   | Finds          | Date    |
| 15500   | Layer |         | 2         | 0.22      | Ploughsoil. Dark brownish grey, silty loam, friable |                |         |
| 15501   | Layer |         | 2         |           | Natural. Light greyish brown, silty clay, firm      |                |         |

| <b>Trench 156</b>  |       |         |           |           |   |       |       |
|--|-------|---------|-----------|-----------|---|-------|-------|
| General description  |       |         |           |           | Orientation   |       | NW-SE |
| Trench consists of a ploughsoil overlying a natural of silty clay.<br>Trench devoid of archaeology.          |       |         |           |           | Length (m)  |       | 30    |
|  |       |         |           |           | Width (m)   |       | 2.2   |
|  |       |         |           |           | Avg. depth (m)  |       | 0.25  |
| Context No.  | Type  | Fill Of | Width (m) | Depth (m) | Description   | Finds | Date  |
| 15600  | Layer |         | 2.2       | 0.26      | Ploughsoil. Dark brownish grey, silty loam, friable       |       |       |
| 15601  | Layer |         | 2.2       |           | Natural. Light yellowish brown, silty clay, firm          |       |       |
| <b>Trench 157</b>  |       |         |           |           |   |       |       |
| General description  |       |         |           |           | Orientation   |       | E-W   |
| Trench consists of a ploughsoil overlying a natural of silty clay.<br>Trench contains one charcoal rich pit. |       |         |           |           | Length (m)  |       | 30    |
|  |       |         |           |           | Width (m)   |       | 2.2   |
|  |       |         |           |           | Avg. depth (m)  |       | 0.22  |
| Context No.  | Type  | Fill Of | Width (m) | Depth (m) | Description   | Finds | Date  |
| 15700  | Layer |         | 2.2       | 0.22      | Ploughsoil. Dark brownish grey, silty loam, friable       |       |       |
| 15701  | Layer |         | 2.2       |           | Natural. Light yellowish brown, silty clay, firm          |       |       |
| 15702  | Cut   |         | 0.7       | 0.12      | Pit   |       |       |
| 15703  | Fill  | 15702   | 0.3       | 0.08      | Primary Fill. Mid blackish grey, silty clay, compact.     |       |       |
| 15704  | Fill  | 15702   | 0.32      | 0.05      | Secondary Fill. Dark blackish grey, charcoaly silt, firm. |       |       |
| 15705  | Fill  | 15702   | 0.45      | 0.1       | Secondary Fill. Mid blackish grey, silty clay, compact.   |       |       |
| <b>Trench 158</b>  |       |         |           |           |   |       |       |
| General description  |       |         |           |           | Orientation   |       | N-S   |
| Trench consists of a ploughsoil overlying a natural of silty clay.<br>Trench devoid of archaeology.          |       |         |           |           | Length (m)  |       | 30    |
|  |       |         |           |           | Width (m)   |       | 2.2   |
|  |       |         |           |           | Avg. depth (m)  |       | 0.26  |
| Context No.  | Type  | Fill Of | Width (m) | Depth (m) | Description   | Finds | Date  |
| 15800  | Layer |         | 2.2       | 0.26      | Ploughsoil. Dark brownish grey, silty loam, friable       |       |       |
| 15801  | Layer |         | 2.2       |           | Natural. Light yellowish brown, silty clay, firm          |       |       |

| <b>Trench 159</b>   |       |         |           |           |   |       |       |
|---|-------|---------|-----------|-----------|---|-------|-------|
| General description   |       |         |           |           | Orientation   |       | NE-SW |
| Trench consists of a ploughsoil overlying a natural of silty clay.<br>Trench devoid of archaeology. |       |         |           |           | Length (m)  |       | 30    |
|   |       |         |           |           | Width (m)   |       | 2.2   |
|   |       |         |           |           | Avg. depth (m)                                      |       | 0.3   |
| Context No.   | Type  | Fill Of | Width (m) | Depth (m) | Description   | Finds | Date  |
| 15900   | Layer |         | 2.2       | 0.3       | Ploughsoil. Dark brownish grey, silty loam, friable |       |       |
| 15901   | Layer |         | 2.2       |           | Natural. Mid reddish brown, silty clay, firm        |       |       |
| <b>Trench 160</b>   |       |         |           |           |   |       |       |
| General description   |       |         |           |           | Orientation   |       | N-S   |
| Trench consists of a ploughsoil overlying a natural of silty clay.<br>Trench devoid of archaeology. |       |         |           |           | Length (m)  |       | 30    |
|   |       |         |           |           | Width (m)   |       | 2.2   |
|   |       |         |           |           | Avg. depth (m)                                      |       | 0.26  |
| Context No.   | Type  | Fill Of | Width (m) | Depth (m) | Description   | Finds | Date  |
| 16000   | Layer |         | 2.2       | 0.26      | Ploughsoil. Dark brownish grey, silty loam, friable |       |       |
| 16001   | Layer |         | 2.2       |           | Natural. Light yellowish brown, silty clay, firm    |       |       |
| <b>Trench 161</b>   |       |         |           |           |   |       |       |
| General description   |       |         |           |           | Orientation   |       | E-W   |
| Trench consists of a ploughsoil overlying a natural of silty clay.<br>Trench devoid of archaeology. |       |         |           |           | Length (m)  |       | 30    |
|   |       |         |           |           | Width (m)   |       | 2.2   |
|   |       |         |           |           | Avg. depth (m)                                      |       | 0.3   |
| Context No.   | Type  | Fill Of | Width (m) | Depth (m) | Description   | Finds | Date  |
| 16100   | Layer |         | 2.2       | 0.3       | Ploughsoil. Dark brownish grey, silty loam, friable |       |       |
| 16101   | Layer |         | 2.2       |           | Natural. Light yellowish brown, silty clay, firm    |       |       |
| <b>Trench 162</b>   |       |         |           |           |   |       |       |
| General description   |       |         |           |           | Orientation   |       | NE-SW |
| Trench consists of a ploughsoil overlying a natural of silty clay.<br>Trench devoid of archaeology. |       |         |           |           | Length (m)  |       | 20    |
|   |       |         |           |           | Width (m)   |       | 2.2   |
|   |       |         |           |           | Avg. depth (m)                                      |       | 0.25  |
| Context No.   | Type  | Fill Of | Width (m) | Depth (m) | Description   | Finds | Date  |
| 16200   | Layer |         | 2.2       | 0.26      | Ploughsoil. Dark brownish grey, silty loam, friable |       |       |

|  |       |         |           |           |  |       |         |
|--|-------|---------|-----------|-----------|--|-------|---------|
| 16201  | Layer |         | 2.2       | 0.25      | Natural. Light yellowish brown, silty clay, firm         |       |         |
| <b>Trench 163</b>  |       |         |           |           |  |       |         |
| General description  |       |         |           |           | Orientation  |       | N-S     |
| Trench consists of a ploughsoil overlying a natural of silty clay. Trench devoid of archaeology. |       |         |           |           | Length (m)   |       | 30      |
|  |       |         |           |           | Width (m)  |       | 2.2     |
|  |       |         |           |           | Avg. depth (m)   |       | 0.3     |
| Context No.  | Type  | Fill Of | Width (m) | Depth (m) | Description  | Finds | Date    |
| 16300  | Layer |         | 2.2       | 0.3       | Ploughsoil. Dark brownish grey, silty loam, friable      |       |         |
| 16301  | Layer |         | 2.2       |           | Natural. Light yellowish brown, silty clay, firm         |       |         |
| <b>Trench 164</b>  |       |         |           |           |  |       |         |
| General description  |       |         |           |           | Orientation  |       | NW-SE   |
| Trench consists of a ploughsoil overlying a natural of silty clay. Trench devoid of archaeology. |       |         |           |           | Length (m)   |       | 30      |
|  |       |         |           |           | Width (m)  |       | 2.2     |
|  |       |         |           |           | Avg. depth (m)   |       | 0.3     |
| Context No.  | Type  | Fill Of | Width (m) | Depth (m) | Description  | Finds | Date    |
| 16400  | Layer |         |           | 0.3       | Ploughsoil. Loose dark greyish brown, silty loam.        |       |         |
| 16401  | Layer |         |           |           | Natural. Firm mid yellowish brown clay.                  |       |         |
| <b>Trench 165</b>  |       |         |           |           |  |       |         |
| General description  |       |         |           |           | Orientation  |       | E-W     |
| Trench consists of a ploughsoil overlying a natural of silty clay. Trench contains one ditch,    |       |         |           |           | Length (m)   |       | 30      |
|  |       |         |           |           | Width (m)  |       | 2.2     |
|  |       |         |           |           | Avg. depth (m)   |       | 0.24    |
| Context No.  | Type  | Fill Of | Width (m) | Depth (m) | Description  | Finds | Date    |
| 16500  | Layer |         | 2.2       | 0.24      | Ploughsoil. Dark brownish grey, silty loam, friable      |       |         |
| 16501  | Layer |         | 2.2       |           | Natural. Light yellowish brown, silty clay, firm         |       |         |
| 16502  | Cut   |         | 0.82      | 0.32      | Ditch  |       |         |
| 16503  | Fill  | 16502   | 0.8       | 0.25      | Secondary Fill. Mid orangish grey, silty clay, soft.     | Pot   | MBA–EIA |
| 16504  | Fill  | 16502   | 0.54      | 0.14      | Secondary Fill. Light orangish grey, silty clay compact. |       |         |



| <b>Trench 166</b>   |       |         |           |           |   |       |       |
|---|-------|---------|-----------|-----------|---|-------|-------|
| General description   |       |         |           |           | Orientation   |       | NW-SE |
| Trench consists of a ploughsoil overlying a natural of silty clay.<br>Trench devoid of archaeology. |       |         |           |           | Length (m)  |       | 30    |
|   |       |         |           |           | Width (m)   |       | 2.2   |
|   |       |         |           |           | Avg. depth (m)                                      |       | 0.26  |
| Context No.   | Type  | Fill Of | Width (m) | Depth (m) | Description   | Finds | Date  |
| 16600   | Layer |         | 2.2       | 0.26      | Ploughsoil. Dark brownish grey, silty loam, friable |       |       |
| 16601   | Layer |         | 2.2       |           | Natural. Light yellowish brown, silty clay, firm    |       |       |
| <b>Trench 167</b>   |       |         |           |           |   |       |       |
| General description   |       |         |           |           | Orientation   |       | NW-SE |
| Trench consists of a ploughsoil overlying a natural of silty clay.<br>Trench devoid of archaeology. |       |         |           |           | Length (m)  |       | 30    |
|   |       |         |           |           | Width (m)   |       | 2.2   |
|   |       |         |           |           | Avg. depth (m)                                      |       | 0.24  |
| Context No.   | Type  | Fill Of | Width (m) | Depth (m) | Description   | Finds | Date  |
| 16700   | Layer |         | 2.2       | 0.24      | Ploughsoil. Dark brownish grey, silty loam, friable |       |       |
| 16701   | Layer |         | 2.2       |           | Natural. Light yellowish brown, silty clay, firm    |       |       |

## Appendix B Finds Reports

### B.1 Prehistoric Pottery

By Alex Davies

- B.1.1 The assemblage of prehistoric pottery from both Land Parcels 55 and 56 is small, comprising 22 sherds, weighing 62g in total, recovered from six contexts across the site.

#### Land Parcel 56

- B.1.2 The evaluation recovered 17 sherds of dated prehistoric pottery, weighing 58g, from five contexts across three trenches (Table 1). The assemblage is small with no diagnostic sherds, and dating is based primarily on fabrics.
- B.1.3 All the sherds contain flint, and sherds from three of the contexts also have sand in the fabric. Flint temper is ubiquitous in prehistoric pottery of most periods in the region making dating very difficult in the absence of diagnostic material, and the spot dates are tentative.
- B.1.4 The combination of sand and flint in contexts 5403, 13304 and 13010 is more suggestive of the Iron Age than the later Bronze Age (Mucking: Brudenell 2016a, 160; 2016b, 380; South Hornchurch: Harrison 2000, 337-8). The early Iron Age is more likely given the absence of glauconitic sand (this would be expected in the middle Iron Age), although the quantities are too small for relative fabric proportions to have much meaning. The sherds from context 16503 are thicker with coarser flint inclusions and might be middle Bronze Age in date, although the spot date should be broadened to include the late Bronze Age and the early Iron Age.

| Context      | Count     | Weight (g) | Fabric           | Date        | Comment                |
|--------------|-----------|------------|------------------|-------------|------------------------|
| 5403         | 2         | 10         | Sand, flint, med | E/MIA       |                        |
| 13304        | 1         | 1          | Sand, flint, med | E/MIA?      | Very small and abraded |
| 13008        | 2         | 1          | Flint            | Prehistoric | Very small and abraded |
| 13010        | 10        | 20         | Sand, flint, med | LBA/EIA     | 1x plain rim           |
| 16503        | 2         | 26         | Flint, coarse    | MBA-EIA     |                        |
| <b>Total</b> | <b>17</b> | <b>58</b>  |                  |             |                        |

Table 1: Prehistoric pottery

#### Land Parcel 55

- B.1.5 A single context, fill 2904 of posthole 2903, produced five ceramic fragments of indeterminate form and character, weighing 4g in total. There was no visible temper, and the fragments are undated.

## B.2 Late Iron Age and Roman Pottery

By Edward Biddulph

### Introduction

B.2.1 Some 483 sherds of late Iron Age and Roman pottery, weighing 7271g, were recovered from the evaluation (Table 2). Context groups were sorted into fabrics, and each fabric group quantified by sherd count and weight in grams. Fabrics were assigned codes devised by the Essex County Council Field Archaeology Unit (cf. Biddulph *et al.* 2015). Forms were identified by rim and quantified by minimum number of vessels (MV) and estimated vessel equivalents (EVE), which measure the surviving percentage of the rim circumference (thus, 0.25 EVE equals 25%). Forms codes were taken from Going's Chelmsford typology (Going 1987), which is applicable more widely in Essex, and supplemented by typologies specific to ware: Young (1977) for the Oxford industry and Webster (1996) for samian wares. Forms and fabrics are quantified in Tables 2 and 3.

B.2.2 The following forms were recorded:

- B – dish
- B3 – dish with groove below rim
- B5 – incipient bead-and-flanged dish
- B6 – bead-and-flanged dish
- D5 – mortarium with flange and tall bead
- E5 – necked bowl-jar with rounded body
- E5.4 – necked bowl-jar with rounded body; neck decorated with burnished wavy line
- G – jar
- G5.5 – neckless, lid-seated jar
- G23/G24 – necked jar
- G24 – oval-bodied, necked jar
- G28 – necked jar with bifid rim
- G37 – narrow-necked jar with undercut rim
- G40 – flask
- G44 – storage jar
- H39/H40 – funnel-necked beaker
- R3 – miniature necked jar

| Fabric       | Description   | No. sherds | Weight (g)  | MV        | EVE         |
|--------------|---|------------|-------------|-----------|-------------|
| BB2          | Black-burnished ware, category 2                    | 2          | 7           | 2         | 0.1         |
| BSW          | Black-surfaced wares                                | 21         | 303         | 3         | 0.39        |
| BUF          | Miscellaneous buff wares                            | 1          | 10          |           |             |
| COLC         | Colchester colour-coated ware (COL CC 2)            | 3          | 5           |           |             |
| EGSW         | East Gaulish samian ware                            | 5          | 197         | 1         | 0.03        |
| ESH          | Early shell-tempered ware                           | 1          | 39          | 1         | 0.07        |
| GRF          | Fine grey wares                                     | 5          | 17          | 1         | 0.6         |
| GROG         | Fine grog-tempered ware (SOB GT)                    | 3          | 26          |           |             |
| GRS          | Sandy grey wares                                    | 399        | 4849        | 25        | 4.82        |
| HAX          | Hadham oxidised ware                                | 4          | 15          |           |             |
| MICW         | Miscellaneous Iron Age coarse wares                 | 3          | 8           |           |             |
| MWSRS M      | Miscellaneous white-slipped sandy red ware mortaria | 1          | 31          |           |             |
| NKG          | North Kent grey ware (UPC FR)                       | 1          | 4           |           |             |
| NVC          | Nene Valley colour-coated ware (LNV CC)             | 1          | 5           |           |             |
| OXWM         | Oxford white ware mortaria (OXF WH)                 | 4          | 195         | 2         | 0.26        |
| RED          | Miscellaneous red wares                             | 1          | 3           |           |             |
| STOR         | Storage jar fabrics                                 | 28         | 1557        | 2         | 0.68        |
| <b>Total</b> |   | <b>483</b> | <b>7271</b> | <b>37</b> | <b>6.95</b> |

Table 2: Quantification of late Iron Age and Roman fabrics (codes in brackets from Tomber and Dore 1998)

| Form             | BB2        | BSW         | EGSW        | ESH         | GRF        | GRS         | OXWM       | STOR        | Total EVE   |
|------------------|------------|-------------|-------------|-------------|------------|-------------|------------|-------------|-------------|
| B                | 0.05       |             | 0.03        |             |            |             |            |             | 0.08        |
| B3               | 0.05       |             |             |             |            |             |            |             | 0.05        |
| B5               |            | 0.15        |             |             |            | 0.14        |            |             | 0.29        |
| B6               |            |             |             |             |            | 0.65        |            |             | 0.65        |
| D5               |            |             |             |             |            |             | 0.3        |             | 0.26        |
| E5               |            |             |             |             |            | 0.16        |            |             | 0.16        |
| E5.4             |            |             |             |             |            | 0.25        |            |             | 0.25        |
| G                |            |             |             | 0.07        |            | 1.05        |            | 0.33        | 1.45        |
| G5.5             |            |             |             |             |            | 0.2         |            |             | 0.2         |
| G23/G24          |            |             |             |             |            | 0.07        |            |             | 0.07        |
| G24              |            |             |             |             |            | 1.1         |            |             | 1.1         |
| G28              |            |             |             |             |            | 0.29        |            |             | 0.29        |
| G37              |            | 0.1         |             |             |            | 0.37        |            |             | 0.47        |
| G40              |            | 0.14        |             |             |            | 0.1         |            |             | 0.24        |
| G44              |            |             |             |             |            |             |            | 0.35        | 0.35        |
| H39/H40          |            |             |             |             |            | 0.6         |            |             | 0.6         |
| R3               |            |             |             |             |            | 0.44        |            |             | 0.44        |
| <b>Total EVE</b> | <b>0.1</b> | <b>0.39</b> | <b>0.03</b> | <b>0.07</b> | <b>0.6</b> | <b>4.82</b> | <b>0.3</b> | <b>0.68</b> | <b>6.95</b> |

Table 3: Quantification by EVE of Roman pottery forms

## **Assemblage composition**

- B.2.3 Grog-tempered body sherds (GROG) collected from Trenches 50 and 120 are dated to the late Iron Age or early Roman period. The pottery from Trench 120 was found with medieval material and was therefore residual, as were a jar rim in early shell-tempered ware (ESH) and few tiny fragments in a flint-tempered fabric (MICW), recovered from context 3903 with late Roman pottery. The remaining pottery was recovered from groups spot dated to the late Roman period (c AD 250/70-410).
- B.2.4 Some 93% of the assemblage by sherd count was recovered from a pit or ditch terminus (3702) in Trench 37. The pottery from the feature was dominated by sandy grey wares (GRS). Forms in the fabric include dishes with incipient bead-and-flanged rims (Going 1987, type B5) and dishes with bead-and-flanged rims (type B6), which together suggest a late 3rd-century date or later for deposition. The date is supported by the presence of two Oxford white ware mortaria (Young 1977, type M17), which have a date range of c AD 240-300. A wide-mouthed jar or so-called 'bowl-jar' (Going 1987, type E5.4) in fabric GRS, a funnel-necked beaker (type H39/H40) in fine grey ware (GRF) and the presence of Hadham oxidised ware (HAX) is also consistent with late Roman deposition.
- B.2.5 Pottery from context 3903, a fill of ditch 3902, is also likely to have been deposited during the late Roman period or later, as suggested by the presence of fabric HAX and a narrow-necked jar (type G37) in black-surfaced ware (BSW).
- B.2.6 Although no groups were dated to the early or middle Roman periods (c AD 43-250), pottery of that date, notably samian ware (EGSW), North Kent grey ware (NKG) and Colchester colour-coated ware (COLC), was present in late Roman groups. These may be residual, pointing to earlier activity in the area or may represent older vessels that remained in use into the later 3rd century.

## **Discussion**

- B.2.7 The evaluation area lies south of Junction 29, Hobbs Hole, one of 29 sites investigated along section 4 of the M25 widening scheme (Biddulph and Brady 2015). A large pottery assemblage of over 5000 sherds was recovered from the site, and though early and middle Roman pottery was represented in reasonable quantity, over half the assemblage belonged to the late Roman period. Notably, an Oxford white ware mortarium (Young 1977, type M17) was among the late Roman material collected (Biddulph 2015, 39-44). The assemblage from the current site is similar to Hobbs Hole in terms of composition and chronology, and it is likely that the pottery from both sites derive from the same settlement.
- B.2.8 The condition of the assemblage is good. It has a mean sherd weight (weight divided by sherd count) of 15g and a mean EVE or 'completeness' value of 0.19 EVE, which is indicative of large sherds and relatively large portions of rim circumferences. (This includes the pottery recovered from samples taken from feature 3702.) One vessel, a necked jar (Going 1987, type G24) in fabric GRS from context 3704 (feature 3702), has a complete, though fragmented, rim. While Roman-period features were sparsely distributed in the evaluation, the condition of the Roman pottery is consistent with relatively rapid deposition after breakage, potentially not too far away from areas of pottery use and the focus of settlement.

## **Recommendations regarding the conservation, discard and retention of material**

- B.2.9 The pottery reported on here has the potential to inform future research through re-analysis and thus it is recommended that all the pottery is retained. This follows the advice set out in the 'Standard for Pottery Studies in Archaeology' (PCRG *et al.* 2016).

## B.3 Medieval Pottery

By John Cotter

### Introduction

- B.3.1 A total of 53 sherds of medieval and post-medieval pottery, weighing 253g, were recovered from 13 contexts. Ordinary domestic wares were recovered. A range of pottery dating from perhaps the 10th century through to the 19th century was identified. Nearly all of this, however, is medieval.
- B.3.2 All the pottery was scanned during the present assessment and spot dates were provided for each context. Each context group was quantified by sherd count and weight, and recorded on a spot dating spreadsheet. The pottery is mostly in a very fragmentary and abraded condition, but some fresh sherds are also present.
- B.3.3 The context spot date is the date-bracket during which the latest pottery types or fabrics are estimated to have been produced or were in general circulation. Comments on the range of fabrics were recorded, usually with mention of vessel form (jugs, bowls etc) and any other attributes worthy of note (eg decoration etc). Fabric codes referred to are those of the Museum of London (MOLA 2014). Where appropriate, these are cross-referenced to the fabric codes used by Essex County Council (Cotter 2000, 12-13). The range of pottery is described in some detail in the spreadsheet (Table 4) and is therefore only summarised below.

### Description

| Context | Spot date    | Sherds | Weight | Comments   |
|---------|--------------|--------|--------|--|
| 4603    | c 900-1050?  | 1      | 6      | Neck/shoulder bo (body sherd) from jar/cook pot in reduced grey sand-free shelly ware with coarse shell. Probably London Late Saxon shelly ware (LSS, c 900-1050)? Otherwise poss early medieval shelly ware EMSH (c 1050-1150)? Sooted ext                                      |
| 4606    | c 900-1050   | 7      | 70     | All Late Saxon shelly ware (LSS) incl typical everted/cavetto jar/cook pot rim with flattened top. The rim and one larger very thick bo are wheel-turned. Abundant coarse shell, little or no sand. Brownish int surfaces with grey core; grey-brown ext. Fairly fresh condition |
| 4703    | c 1000-1225? | 1      | 7      | Worn bo shelly ware with very fine sand and dissolved-out shelly voids (finer than LSS). Possibly Essex EMSHX (c 1000-1225)? Or London early med shelly ware (EMSH, c 1050-1150)?  |
| 4709    | c 900-1050   | 2      | 10     | Thick-walled bos. Probably LSS   |
| 5003    | c 1000-1225? | 1      | 2      | Worn scrap sand-free shellyware. Poss EMSHX? Leached pale brown colour ext   |

| Context      | Spot date    | Sherds    | Weight     | Comments   |
|--------------|--------------|-----------|------------|--|
| 5005         | c 1750-1900  | 5         | 43         | 1x v abraded bo from a wide bowl in post-med red earthenware (PMR) with thin brown glaze int, groove on inside below missing rim - late-looking L18/19C. 4x coarse sand-free shelly ware poss EMSHX (c 1000-1225) incl rim sherd from v wide cook pot or bowl with vertical neck and thickened flat-topped rim (11/12C?)   |
| 5007         | c 1000-1225? | 1         | 10         | Sagging/flat base sherd coarse shelly EMSHX?   |
| 5012         | c 1200-1400? | 4         | 13         | 1x scrap wheel-turned orange sandy ware - medieval Essex Fabric 21 (London code SOWX, c 1200-1550). 2x coarse shelly EMSHX? 1x sherd/flake (5g) from curved object or pot in v fine brickearth fabric, grey, poss scorched - possibly fired clay rather than pot?  |
| 5013         | c 1200-1350  | 18        | 67         | 1x bo from jug in London-type ware (LOND, c 1080-1350) from a jug with traces of vertical white strip decoration under a green glaze (c 1200-1350). 1x fresh sag base in fine grey-brown silty, micaceous, ware with sparse fine calcareous inclusions - also poss London-type ware? or unidentified local ware (fabric similar to London early med sandy ware EMS, c970-1100). 1x bo coarse shelly-sandy ware (SSWX, c 1100-1350). The other sherds are sand-free/low-sand shelly wares (EMSHX?) incl 2 simple everted cook pot rims, some of these shelly sherds little more than scraps |
| 5100         | c 1000-1225? | 3         | 3          | Bos/scraps shelly EMSHX?   |
| 12003        | c 1000-1225? | 6         | 16         | 5x bos/scraps shelly EMSHX? (or possibly late Saxon LSS?). 1x scrap (1g) coarse flint-tempered ware with some shell - possibly early med flint-tempered ware (EMFL, c 970-1100)?   |
| 12004        | c 1200-1400? | 2         | 5          | 1x small bo in fine-medium oxid sandy ware with sparse fine flint - probably Essex Fabric 21 (SOWX) from a thin-walled jug with a decayed green glaze ext (or from a coarser LOND jug?). 1x bo smooth oxid shelly EMSHX but poss 13/14C?   |
| 12805        | 10-13C?      | 2         | 1          | Scraps shelly ware, some organic inclusions. Unident but poss late Saxon to 13C? (LSS or EMSHX?)   |
| <b>Total</b> |              | <b>53</b> | <b>253</b> |  |

Table 4: Description of post-Roman pottery by context

## Discussion

B.3.4 The pottery comprises ordinary domestic wares typical of this part of south Essex and covers a date range possibly from the 10th or 11th century to the late 18th or 19th century. However, all but one sherd of pottery falls within a 10th- to 14th-century



date bracket. The medieval pottery recovered alongside the single post-medieval sherd (Fabric PMR) is considered to have been residual within the context (5005), as the ditch corresponds with a late post-medieval field boundary depicted on OS mapping.

- B.3.5 Nearly all the pottery comprises types of local, or fairly local, medieval shelly wares. The small/abraded condition of many of these shelly ware sherds, however, makes positive identification to known fabric types almost impossible in several instances. Late Saxon shelly ware (LSS, c 900-1050) has been positively identified in at least two contexts (4603 and 4606), including a typical jar/cooking pot rim. The remaining shelly wares are predominantly sand-free shelly fabrics with a broad 11th- to 13th-century, or even early 14th-century, dating (mainly EMSHX, c 1000-1225). Three rims and a couple of base sherds are the only featured sherds amongst these fabrics.
- B.3.6 Sherds from medieval glazed jugs (in sandy ware fabrics) are rare. These are confined to a body sherd from a jug in London-type ware (LOND) with applied strip decoration and green glaze (c 1200-1350) and two body sherds in Essex medieval orange sandy ware (SOWX/Essex Fabric 21), including a green-glazed sherd probably dating to c 1200-1400.

**Recommendations regarding the conservation, discard and retention of material**

- B.3.7 The pottery here has some potential to inform research through re-analysis and should be retained.

## B.4 Flint

By Lawrence Billington and Geraldine Crann

### Introduction

- B.4.1 A small assemblage of eight worked flints and 139g (25 fragments) of unworked burnt flint was recovered during the evaluation. The assemblage is quantified by type and context in Table 5.
- B.4.2 The assemblage was catalogued directly onto an Excel spreadsheet and the artefacts were classified according to a system of broad artefact/debitage types based on standard definitions for post-glacial lithic assemblages from southern Britain (eg Bamford 1985, 72-7; Healy 1988, 48-9; Butler 2005). Additional information on selected technological and non-metric attributes of the material (including platform type/preparation, hammer mode and dorsal cortex coverage) was also recorded using standard classifications and terminology based largely on those set out by Inizan (Inizan *et al.* 1999).

| Trench | Context | Cut   | Feature type | Irregular waste | Flake    | Blade    | End scraper | Unworked burnt flint count | Unworked burnt flint weight (g) |
|--------|---------|-------|--------------|-----------------|----------|----------|-------------|----------------------------|---------------------------------|
| 10     | 1010    | 1004  | Ditch        |                 |          |          |             | 1                          | 5                               |
| 50     | 5012    | 5011  | Pit          |                 |          |          |             | 3                          | 7.8                             |
| 50     | 5013    | 5011  | Pit          |                 | 1        |          |             | 10                         | 80.2                            |
| 51     | 5103    | 5102  | Ditch        | 1               |          |          |             |                            |                                 |
| 106    | 10600   | 10600 | Ploughsoil   |                 |          |          | 1           |                            |                                 |
| 120    | 12000   | 12000 | Ploughsoil   | 1               |          |          |             |                            |                                 |
| 120    | 12004   | 12002 | Ditch        |                 | 1        |          |             |                            |                                 |
| 130    | 13008   | 13007 | Pit          |                 | 1        | 2        |             |                            |                                 |
| 133    | 13304   | 13303 | Ditch        |                 |          |          |             | 8                          | 20.6                            |
| 133    | 13306   | 13305 | Pit          |                 |          |          |             | 1                          | 1.3                             |
| 133    | 13308   | 13307 | Pit          |                 |          |          |             | 2                          | 23.8                            |
|        |         |       | <b>Total</b> | <b>2</b>        | <b>3</b> | <b>2</b> | <b>1</b>    | <b>25</b>                  | <b>138.7</b>                    |

Table 5. Quantification of the flint assemblage

### Results

- B.4.3 A single piece of burnt unworked flint, weighing 5g, was recovered from context 1010, environmental sample 1. The burnt flint may have come from flint nodules used as potboilers, it may have been deliberately burnt as a temper for clay in the production of pottery or simply be natural flint that has been in the vicinity of a fire.
- B.4.4 In Trench 50, pit 5011 produced a single primary flake and 88g of unworked burnt flint (13 fragments, mean clast weight 6.8g).
- B.4.5 A single piece of irregular, non-bulbar, shatter was recovered from ditch 5102, Trench 51.

- B.4.6 In Trench 106, an end scraper made on a fine laminar secondary flake was recovered from the ploughsoil (10600). Although not strongly diagnostic, this is perhaps most likely to be of Neolithic date.
- B.4.7 A piece of irregular waste was collected from the ploughsoil of Trench 120 (12000), whilst ditch 12002 produced a single hard-hammer struck secondary flake.
- B.4.8 Three struck flints were recovered from the fill of pit 13007 in Trench 130. These comprise a squat tertiary flake and two fine prismatic blades, the latter of Mesolithic or earlier Neolithic date.
- B.4.9 In Trench 133, three features (ditch 13303 and pits 13305 and 13307) produced small assemblages of unworked burnt flint, totalling 46g (11 fragments).

### **Discussion**

- B.4.10 Although small, the flint assemblage does provide some evidence for prehistoric activity at the site. Perhaps most significant are the three struck flints from pit 13007 in Trench 130, which include two Mesolithic/earlier Neolithic blades, and may represent material broadly contemporary with the feature from which it derives. The single flake and moderate quantity of burnt flint from pit 5011 in Trench 50, none of which is chronologically diagnostic, was found alongside medieval pottery and fired clay, and so is considered to have been residual within the pit. Having been recorded, the burnt unworked flint may be discarded, but the worked flints should be retained.

## **B.5 Ceramic Building Material and Fired Clay**

By Cynthia Poole

### **Introduction**

B.5.1 The assemblage of ceramic building material (CBM) and fired clay from both Land Parcels 55 and 56 is small and unremarkable; no material was recovered from trenches in Land Parcel 58. Land Parcel 56 produced material from Trenches 37, 47, 50-2, 60, 63, 120, 126, 128, 133 and 140, and Land Parcel 55 from Trenches 10 and 18. The assemblage consists of small poorly preserved fragments, moderately abraded with a very low mean fragment weight of 17g for the CBM and 6g for the fired clay. The assemblage contains CBM of varying date, comprising Roman and post-medieval material, and fired clay, which is intrinsically undatable but is associated with other materials of Roman and medieval/post-medieval date. The whole assemblage has been spot dated as far as possible and recorded on an Excel sheet, summarised in Tables 6 and 7. Fabrics were characterised on the basis of macroscopic features supplemented by the use of x20 hand lens for finer constituents. Recording was in accordance with ACBMG 2007 and following Brodrigg 1987.

### **Fabrics**

B.5.2 The fabrics from Land Parcels 55 and 56 are dominated by fine sandy-silty clay, sometimes lightly micaceous, and rarely containing small iron oxide inclusions. Most pieces are fired to red or orange, occasionally with a pink or cerise tinge and sometimes with a grey core. A small number of pieces have a slightly coarser sandy fabric.

### **Land Parcel 56**

B.5.3 Ceramic building material from this area amounts to 24 fragments weighing 183g. Roman tile comprises a flat tile 18mm thick and brick 38mm thick, both with burning on the surface and found residually in medieval/post-medieval pits in Trenches 47 and 50. The remainder of the CBM is post-medieval in date and consists of flat roof tile and brick. The roof tile is all of flat rectangular form, measuring 11-13mm thick, probably of peg tile type, though no peg holes survive. It is all fairly neatly made, and undersides are coated in fine moulding sand, suggesting a post-medieval rather than medieval date. The brick is all very fragmentary with no complete dimensions surviving, though all pieces identified as probable brick are thicker than roof tile. One may have the remains of a shallow frog, suggesting an early 19th-century date, though this is uncertain in view of its fragmentary character. A few undated indeterminate scraps occurred in topsoil/subsoil deposits apart from one in a pit of Roman date.

B.5.4 Fired clay amounts to 83 fragments weighing 398g. The largest group was concentrated in pit 3702, which produced pottery dated to AD 270-300. Much of this group consists of small indeterminate scraps recovered from sieved samples typical of the material associated with rake-out from ovens or hearths. In addition to this were a few fragments with a smooth flat surface and burnt light grey grading through greyish brown to red at the underside, which appears to represent the worn interface between fire and unfired structure. These pieces are probably part of a hearth floor, and it is probable that a lump of burnt mudstone with a similar grey surface on one

side was incorporated in the surface. There are also some fragments with smooth moulded surface curving to an edge and fired to a red exterior and black core, which may be pieces of portable oven/hearth furniture.

B.5.5 Fired clay from other contexts is all indeterminate form, mostly amorphous fragments, but a few pieces have remains of a flat surface. Some of this occurred in medieval pits 4708 and 5011, and other scraps were recovered from a tree-throw hole (5014) and subsoil.

| Context | Spot date | Nos | Wt (g) | Material   | Form                                    | Comments       |
|---------|-----------|-----|--------|------------|---|----------------|
| 3704    | Undated   | 1   | 3      | CBM        | Indeterminate                           |                |
| 3704    | Preh-Med  | 15  | 102    | Fired Clay | Indeterminate                           |                |
| 3704    | Undated   | 1   | 19     | Stone      | Mudstone                                | Burnt          |
| 3705    | Preh-Med  | 17  | 211    | Fired Clay | Hearth floor;<br>?Oven/hearth furniture |                |
| 4709    | RB        | 1   | 19     | CBM        | Flat tile                               | Burnt surfaces |
| 4709    | Preh-Med  | 25  | 53     | Fired Clay | Indeterminate                           |                |
| 5003    | RB        | 1   | 98     | CBM        | Roman brick                             |                |
| 5005    | Pmed      | 3   | 65     | CBM        | Flat roof (peg), ?Brick                 |                |
| 5012    | Preh-Med  | 8   | 11     | Fired Clay | Indeterminate                           |                |
| 5013    | Preh-Med  | 3   | 8      | Fired Clay | Indeterminate                           |                |
| 5014    | Preh-Med  | 4   | 11     | Fired Clay | Indeterminate                           |                |
| 5100    | Pmed      | 1   | 8      | CBM        | Flat roof (peg)                         |                |
| 5203    | Pmed      | 2   | 20     | CBM        | Flat roof (peg)                         |                |
| 6000    | Undated   | 6   | 18     | CBM        | Indeterminate                           |                |
| 12003   | Undated   | 2   | 3      | CBM        | Indeterminate                           |                |
| 12604   | Pmed      | 2   | 25     | CBM        | Flat roof (peg)                         |                |
| 12805   | Pmed      | 1   | 7      | CBM        | Flat roof (peg)                         |                |
| 13304   | Preh-Med  | 11  | 2      | Fired Clay | Indeterminate                           |                |
| 14003   | Pmed?     | 4   | 132    | CBM        | Brick?                                  |                |

Table 6: CBM and fired clay assemblage - Land Parcel 56

### Land Parcel 55

B.5.6 This area produced nine fragments of CBM, weighing 179g, and a single fragment of fired clay (4g), all found in ditch fills in Trenches 10 and 18. A single fragment with roughly finished surfaces was probably part of a Roman brick; no complete dimensions survive, but it appears to thicken to the edge creating a slightly dished upper surface, which is a feature of Roman brick. The majority of the CBM comprises fragments of flat rectangular roof tile measuring 12-14mm thick, probably peg tile, though no peg or nail holes survive. A fragment of field drain, 14mm thick, appears to be U-shaped in profile and was pierced by a circular perforation 12mm in diameter. These characteristics suggest it is a 'horseshoe' type of early to mid-19th-century date.

B.5.7 The small scrap of fired clay has two flat undulating surfaces joining at an obtuse angle, but insufficient survives to attribute any function.

| Context | Spot date | Nos | Wt (g) | Material | Form            | Comments                         |
|---------|-----------|-----|--------|----------|-----------------|----------------------------------|
| 1010    | Preh-Med  | 1   | 4      | FC       | Indeterminate   |                                  |
| 1008    | E-MC19    | 1   | 69     | CBM      | Field drain     | ?Horseshoe type with perforation |
| 1009    | PMed      | 2   | 40     | CBM      | Flat roof (peg) |                                  |
| 1804    | RB?       | 1   | 39     | CBM      | Flat/?Brick RB  |                                  |
| 1806    | PMed      | 5   | 31     | CBM      | Flat roof (peg) |                                  |

Table 7: CBM and fired clay assemblage – Land Parcel 55

## Conclusions

- B.5.8 The Roman CBM represents reuse of tile in ovens or hearths and, though occurring residually in later features, no doubt relates to the Roman activity found elsewhere on the site. The fired clay from pit 3702 is also indicative of Roman hearth structure probably domestic in character.
- B.5.9 The post-Roman CBM has all been dated as post-medieval and, though some of it occurs in ditch 5004 with medieval pottery, there are no characteristics that could firmly assign it to an earlier date. However, peg tile changed very little from its inception in the 12th century until mechanisation in the 19th century, and the later date is based essentially on the neatness and finish of the fragments. The majority of the CBM occurs scattered across the site in topsoil and subsoil deposits in Land Parcel 56 and in ditch fills in Land Parcel 55, and it seems likely that it represents incidental deposition in the process of agricultural activities such as manuring or field drainage.

## Recommendations

- B.5.10 The assemblages from both land parcels are small and, whilst providing some supplementary dating evidence for the contexts, contain no items of intrinsic interest. Further research potential is extremely limited, and the material may therefore be discarded if desired at completion of the project. In general, the archive record should be sufficient in any wider research encompassing the site or the material.

## B.6 Small Finds

By Anni Byard

### Introduction and methodology

- B.6.1 A total of 11 iron objects (12 pieces, 31.4g) and two shards of glass (5.6g) were recovered from six contexts across Land Parcels 55 and 56 (Table 8).
- B.6.2 All small finds were scanned during the present assessment and, where possible, century or broad period dates were assigned. Objects were quantified by type count and weight by context and recorded on a spreadsheet.

| Land Parcel | Context | SF no. | Material | Count | Weight (g) | Object          | Date    |
|-------------|---------|--------|----------|-------|------------|-----------------|---------|
| 55          | 1009    | 2      | Fe       | 1     | 4.3        | Nail            | Modern? |
| 55          | 1010    |        | Glass    | 2     | 5.6        | Bottle          | Modern  |
| 55          | 1806    | 1      | Fe       | 2     | 13.4       | Nail/<br>Staple | PM/Mod  |
| 56          | 3705    | 1      | Fe       | 1     | 1.6        | Nail?           |         |
| 56          | 5013    |        | Fe       | 2     | 8.5        | Nail            | PM?     |
| 56          | 6303    |        | Fe       | 6     | 3.6        | Sheet           |         |

Table 8: Description of small finds by context

### Discussion

- B.6.3 The assemblage is small and comprises mostly post-medieval/modern, fragmentary objects.
- B.6.4 An incomplete hand-forged nail (SF 2) of probable later post-medieval or early modern date was recovered from context 1009, and a U-shaped staple (SF 1) of similar date was from context 1806.
- B.6.5 A small, sub-square sectioned rod fragment from context 3705 may be from the shaft of a nail. Its dating is uncertain.
- B.6.6 Two nails were recovered from context 5013. One appears complete and has an L-shaped head, tapering rectangular shaft and bent foot. This is potentially a horseshoe nail and is likely to be of post-medieval or early modern date. The second nail fragment comprises a T-shaped head with a short length of shank. This is possibly post-medieval in date.
- B.6.7 The six sheet fragments from context 6303 may have been part of the same object but condition precludes identification.
- B.6.8 Two refitting shards of a moulded, light green glass vessel, possibly a wine bottle of early 20th-century date, were recovered from context 1010.

### Recommendations regarding the conservation, discard and retention of material

- B.6.9 The assemblage is small. Finds of 19th- or 20th-century date have been catalogued and hold no potential for further work; they may be discarded.

### C.1 Environmental Samples

By Richard Palmer

#### Introduction and methodology

C.1.1 One sample was collected as part of the evaluation of Land Parcel 55 and two further bulk samples from Land Parcel 56, primarily for the retrieval and assessment of charred plant remains (CPR) and the recovery of bones and artefacts.

C.1.2 The samples were processed in their entirety at OA using a modified Siraf-type water flotation machine. The flots were collected in a 250µm mesh and residues in a 500µm mesh and dried. The residue fractions were sorted by eye and with the aid of a magnet, while the flot material was sorted using a low power (x10) binocular microscope to extract cereal grains and chaff, smaller seeds and other quantifiable remains.

#### Results

C.1.3 Summary sample and flot abundance data is presented in Table 9. Dating is based on ceramics.

C.1.4 **Trench 10.** Sample 1 (HUP20) was collected from a charcoal dump, fill 1010, from late post-medieval ditch 1004 in Trench 10. A charcoal-rich flot was recovered with the possibility of partial roundwood fragments being present, though no complete fragments (pith to bark/xylem) were identified during initial assessment. An indeterminate grain fragment along with a bedstraw seed (*Galium* sp.) and some charred goosefoot seeds (*Chenopodium* sp.) were also identified. Fragments of glass, burnt flint and fired clay were recovered from the residue.

C.1.5 **Trench 37.** Sample 1 (LTC56W20) collected from fill 3705 of Roman pit 3702 produced a modest flot consisting of charcoal, some of which is ring porous, and modern plant material. Pottery, fired clay, bone and iron were recovered from the residue.

C.1.6 Sample 2 collected from fill 3704 of Roman pit 3702 produced a small flot consisting of charcoal, some of which is ring porous, a glume base fragment that is not further identifiable and modern plant material. Pottery, ceramic building material (CBM) and fired clay were recovered from the residue.

#### Discussion

C.1.7 Recovered material is limited in these samples but may not provide a full indication of the on-site potential for the recovery of charred remains. On its own, the material is of limited interpretative value but may form part of a larger narrative in the event of further work.

#### Recommendations for retention/dispersal

C.1.8 The flots warrant retention until all works on site are complete, though it is not expected that further work on the flots will be required at this time.



| Land Parcel | Sample no. | Context no. | Trench | Feature/<br>deposit | Date | Sample vol. (L) | Flot vol. (ml) | Charcoal<br>>2mm | Grain | Chaff | Weeds | Molluscs | Other | Notes                          |
|-------------|------------|-------------|--------|---------------------|------|-----------------|----------------|------------------|-------|-------|-------|----------|-------|--------------------------------|
| 55          | 1          | 1010        | 10     | 1004                |      | 38              | 50             | ++++             | +     |       | +     |          |       | 10YR 3/4<br>silty clay<br>loam |
| 56          | 1          | 3705        | 37     | 3702                | Rom  | 40              | 50             | +++              |       |       |       |          |       | 10YR 5/2<br>silty clay         |
| 56          | 2          | 3704        | 37     | 3702                | Rom  | 40              | 25             | +++              |       | +     |       |          |       | 10YR 5/2<br>silty clay         |

Key: +=present (up to 5 items), +=frequent (5-25), +++=common (25-100), ++++=abundant (100+)

Table 9: Assessment of bulk soil samples

## C.2 Animal Bone

By Rebecca Nicholson

### Introduction

- C.2.1 A total of 246 animal bone fragments, weighing 1.2kg, was recovered from the site (Table 10), most of which were collected by hand. Features on the site were dated based on associated ceramic finds as prehistoric, Roman or medieval to post-medieval. The great majority of the bone came from medieval-post-medieval contexts. Only one of the sieved samples, sample 1 from context 3705, produced animal bone and then only a small quantity of indeterminate fragments.
- C.2.2 All material from dated contexts was recorded in full, with the aid of the OA skeletal reference collection and standard identification guides, using a diagnostic zone system (Serjeantson 1996). Bone condition was recorded on a semi-quantitative scale of 1 (as fresh) to 5 (extremely poor, corroded and crumbly). Where condition was difficult to score (eg burnt bone and teeth), condition was recorded as 0 (Blank in Fig. 1). Few bones were complete enough to permit measurement, but where possible these are available in the archive and follow von den Driesch (1976). There were no mandibles with sufficient teeth present to enable mean wear stages and ages to be established. Full records will be available with the site archive.

### Description

- C.2.3 Bone preservation varies depending on trench and period but, with the exception of fragments from Trench 50, is typically fair-good (condition 2-3).
- C.2.4 Environmental soil sample 1 from Roman pit fill 3705 produced 11 fragments of animal bone, one of which is calcined (burnt). Several fragments of burnt bone were also recovered from undated context 13306. Evidence of gnawing was confined to a single medium mammal tibia shaft fragment from ditch fill 5503, which was in noticeably better condition than the rest of the bone from that deposit.
- C.2.5 Notable elements of the assemblage include the partial remains of a fairly large adult dog in potentially medieval or post-medieval ditch fill 5503 and fragments of deer antler, probably roe deer (*Capreolus capreolus*), in Roman pit fills 3704 and 3705; the fragment from 3704 has been sawn through and was presumably an offcut from antler working. Several fragments originally thought to be animal bone have, on further inspection, been identified as in fact mineralised wood; contexts with this material include 4603 and 3903.
- C.2.6 Excluding the semi-articulated dog and the deer antler, pig (*Sus scrofa*) is the most frequent animal by number of identified specimens (NISP) followed by cattle (*Bos taurus*) and caprine (sheep [*Ovis aries*] and/or goat [*Capra hircus*]), although with such small numbers of bones relative abundances are not meaningful. A single horse (*Equus caballus*) molar tooth came from ploughsoil 11400.
- C.2.7 Apart from the antler fragment, the only butchery evidence comes from a large unfused cattle distal femur from ploughsoil 5000, which had been sawn through.

| <b>Taxon</b>         | <b>Roman</b> | <b>Med/PMed</b> | <b>Undated</b> | <b>Total</b> |
|----------------------|--------------|-----------------|----------------|--------------|
| Cattle               |              | 2               | 2              | 4            |
| Sheep/goat           |              | 4               |                | 4            |
| Pig                  |              | 4               | 1              | 5            |
| Deer**               | 3**          |                 |                | 3**          |
| Dog*                 |              | 26*             |                | 26*          |
| Horse                |              |                 | 1              | 1            |
| Large mammal         |              | 5               | 13             | 18           |
| Medium mammal        |              | 128             | 7              | 135          |
| Indeterminate Mammal | 12           | 25              | 13             | 50           |
| <b>Total</b>         | <b>15</b>    | <b>194</b>      | <b>37</b>      | <b>246</b>   |

\*=Semi-articulated; \*\*=antler fragments

Table 10: Animal bone assemblage, number of identified fragments by period

## **Conclusions**

- C.2.8 Animal bone is clearly present in the areas excavated and is generally fairly well preserved. The worked antler fragment is noteworthy.
- C.2.9 The assemblage has been fully recorded and, while little can be read into such a small assemblage, the results would be worth considering alongside any future excavations at the site.

## **Recommendations regarding the conservation, discard and retention of material**

- C.2.10 With the exception of the antler and the partial remains of a dog skeleton, the animal bone has little research value and is not considered to be a priority for retention.

## C.3 Shell

By Rebecca Nicholson

### Introduction

- C.3.1 Twenty-one fragments of marine shell, weighing 118g in total, were recovered by hand on site during the trench evaluation. Table 11 provides details of the assemblage by context.

### Description

- C.3.2 The shell is mostly in fair or good condition and all is European flat oyster (*Ostrea edulis*). The shells are mostly of the typical rounded shape for the species, but hinge shape is varied. A small number of shells have evidence of tunnels caused by a bristleworm, probably *Polydora ciliata* (as illustrated in Winder 2011).
- C.3.3 The shells were recovered from the fills of pit 3702 (contexts 3703, 3704, 3705), which have been dated as Roman, post-medieval ditch fill 5005, undated ditch fill 5503 and natural feature 5014.
- C.3.4 Two shells from 3704 have a distinctive purple and orange ‘metallic’ staining of uncertain derivation, but it perhaps relates to trace elements in the burial environment.
- C.3.5 Oysters are relatively common from Roman sites where soils are suitable for shell preservation and may be considered an indicator of Romanisation. The small numbers of shells collected from this evaluation precludes further analysis, but it demonstrates that marine shell is preserved and includes well preserved and complete examples.

| Context | No shells | Wt (g) | No. left valves | No. right valves | Notes   |
|---------|-----------|--------|-----------------|------------------|---|
| 12004   | 2         | 8      |                 | 1                | Small valve, good condition, incomplete.  |
| 4603    | 1         | 1      |                 |                  | Oyster body fragment only   |
| 3703    | 2         | 24     |                 | 2                | 1 complete right oyster valve, fair condition with opening notches opposite hinge. 1 incomplete right valve with trace of <i>Polydora ciliata</i> tunnelling.   |
| 3704    | 11        | 109    | 5               | 4                | Oyster shells of various shapes and sizes, in fair-poor condition, mostly incomplete. 1 large measurable left valve (width 87.8mm, length 70.6mm), large with metallic purple and orange staining outside and inside. 1 right valve also has this staining internally and 1 small right valve has traces. 2 valves have <i>P. ciliata</i> tunnels externally. 2 valves have adhering iron-rich soil concretion adhering. Also 2 body fragments. |
| 3705    | 1         | 3      |                 |                  | 1 small oyster body frag  |
| 5005    | 1         | 21     | 1               |                  | 1 complete oyster valve, Moderate size: 70.6mm width, 64.1mm length. Large triangular hinge.  |
| 5014    | 2         | 6      |                 |                  | One oyster hinge fragment, indeterminate side. One small body fragment.   |
| 5503    | 1         | 16     | 1               |                  | 1 oyster left valve, partially complete. Moderate size with large triangular hinge. Slight orange staining internally.  |

Table 11: Shell assemblage

### **Recommendations for retention/dispersal**

- C.3.6 The shell has been recorded and is not considered to have any significant additional research value. Consequently, retention in the archive is not recommended.

## Appendix D      References

---

- ACBMG, 2007 *Ceramic building material, minimum standards for recovery, curation, analysis and publication*
- Bamford, H, 1985 *Briar Hill: excavation 1974–1978*. Northampton: Northampton Development Corporation Archaeological Monograph **3**
- BGS, 2020 *Geology of Britain Viewer*. <http://mapapps.bgs.ac.uk/geologyofbritain/home.html>
- Biddulph, E, 2015 Late Iron Age and Roman pottery, in Biddulph and Brady 2015, 37–53
- Biddulph, E and Brady, K, 2015 *Excavations along the M25: Prehistoric, Roman and Anglo-Saxon activity between Aveley and Epping, Essex*. Colchester: Essex Society for Archaeology and History, Occasional Papers, New Series, no. **3**
- Biddulph, E, Compton, J and Martin, T S, 2015 The late Iron Age and Roman pottery, in M. Atkinson and S. J. Preston, Heybridge: A late Iron Age and Roman settlement: Excavations at Elms Farm 1993-5. *Internet Archaeology* **40**, <http://dx.doi.org/10.11141/ia.40.1.biddulph1>
- Brodribb, G, 1987 *Roman brick and tile*. Gloucester: Alan Sutton
- Brudenell, M, 2016a Late Bronze Age pottery, in C. Evans, G. Appleby and S. Lucy, with J. Appleby and M. Brudenell, *Lives in the land: Mucking excavations by Margaret and Tom Jones, 1965-1978: prehistoric, context and summary*. Oxford: Oxbow Books, 158–88
- Brudenell, M, 2016b Middle Iron Age pottery, in C. Evans, G. Appleby and S. Lucy, with J. Appleby and M. Brudenell, *Lives in the land: Mucking excavations by Margaret and Tom Jones, 1965-1978: prehistoric, context and summary*. Oxford: Oxbow Books, 365–93
- Butler, C, 2005 *Prehistoric flintwork*. Stroud: Tempus
- ClfA, 2014a *Code of conduct*. Revised October 2019. Chartered Institute for Archaeologists. Retrieved from: [https://www.archaeologists.net/sites/default/files/Code%20of%20conduct%20revOct2019\\_0.pdf](https://www.archaeologists.net/sites/default/files/Code%20of%20conduct%20revOct2019_0.pdf)
- ClfA, 2014b *Standard and guidance for archaeological field evaluation*. Updated October 2020. Chartered Institute for Archaeologists. Retrieved from [https://www.archaeologists.net/sites/default/files/ClfAS%26GFieldevaluation\\_3.pdf](https://www.archaeologists.net/sites/default/files/ClfAS%26GFieldevaluation_3.pdf)
- ClfA, 2014c *Standard and guidance for the creation, compilation, transfer and deposition of archaeological archives*. Revised October 2020. Chartered Institute for Archaeologist.s Retrieved from: [https://www.archaeologists.net/sites/default/files/CIFAS%26GArchives\\_4.pdf](https://www.archaeologists.net/sites/default/files/CIFAS%26GArchives_4.pdf)

- Cotter, J P, 2000 *Post-Roman pottery from excavations in Colchester 1971–1985*. Colchester: Colchester Archaeological Report **7**
- Essex County Council, Historic Environment Branch, 2010 *The Greater Thames Estuary Historic Environment Research Framework: part 1 update and revision of the archaeological research framework for the archaeological research framework for the Greater Thames Estuary 1999*
- Going, C J, 1987 *The Mansio and other sites in the south-eastern sector of the Caesaromagus: the Roman pottery*. London: CBA Res Rep **62**
- Harrison, E, 2000 Pottery and fired clay, in E. Guttmann and J. Last, A Late Bronze Age landscape at South Hornchurch, Essex. *Proc Prehist Soc* **66**, 337–44
- Healy, F, 1988 *The Anglo-Saxon cemetery at Spong Hill, North Elmham, part VI: occupation during the seventh to second millennia BC*, E Anglian Archaeology **39**. Norfolk: Norfolk Archaeological Unit
- Highways England, 2018 *Lower Thames Crossing: a scheme wide specification for archaeological trial trenching*. Unpublished document HE540039-CJV-GEN-GEN-SPE-HER-00001draft, Revision 1.05
- Historic England, 2015 *Management of research projects in the Historic Environment: the MoRPHE project managers' guide*. Centre for Archaeology Guidelines. Swindon: Historic England
- Inizan, M-L, Reduron-Ballinger, M, Roche, H and Tixier, J, 1999 *Technology and terminology of knapped stone*. Nanterre: Cercle de Recherches et d'Etudes Préhistoriques, CNRS
- Medlycott, M (ed.) 2011 *Research and Archaeology revisited: a revised framework for the East of England*. E Anglian Archaeology Occasional Paper **24**. Association of Local Government Archaeological Officers
- MOLA, 2014 *London medieval and post-medieval pottery codes*. Museum of London Archaeology. <http://www.mola.org.uk/medieval-and-post-medieval-pottery-codes> (accessed 11 Jan 2019)
- Oxford Archaeology 2012 *M25 DBFO Section 4: Post-excavation Assessment and Project Design*. Oxford: Oxford Archaeology on behalf of Skanska Balfour Beatty JV
- Oxford Archaeology, 2019a Lower Thames Crossing Scheme-wide written scheme of investigation for trial trenching south of the River Thames, unpublished document
- Oxford Archaeology, 2019b Lower Thames Crossing scheme-wide written scheme of investigation for trial trenching north of the River Thames. Revised August 2020, unpublished document
- Oxford Archaeology, 2020 Lower Thames Crossing detailed written scheme of investigation for trial trenching of Land Parcels 55, 56, 58, 59, 110, 111 and

112, document reference: HE540039-BAL-GEN-GEN-REP-HER-00016,  
unpublished document

Palmer, J J, 2019 *Open Domesday*. <https://opendomesday.org/place/>. University of Hull

PCRG, SGRP, MPRG, 2016 *A standard for pottery studies in archaeology*,  
Prehistoric Ceramics Research Group, Study Group for Roman Pottery, and  
the Medieval Pottery Research Group

Place Services, 2019 *Lower Thames Crossing aerial investigation and mapping  
report*. Chelmsford: Essex County Council

Powell, W R, 1978 *A history of the county of Essex: Victoria County History Volume  
7*

Serjeantson, D, 1996 Animal bone, in S. Needham and T. Spence (eds),  
*Runnymede Bridge research excavations, volume 2: refuse and disposal at  
Area 16 East, Runnymede*. London: British Museum Press, 194–223

Tomber, R and Dore, J, 1998 *The National Roman fabric reference collection: a  
handbook*. London: MOLAS Monograph 2

von den Driesch, A, 1976 *A guide to the measurement of animal bones from  
archaeological sites*. Cambridge, MA: Harvard University Press

Webster, P, 1996 *Roman samian pottery in Britain*. York: Council for British  
Archaeology

Winder, J M, 2011 *Oyster shells from archaeological sites: a brief illustrated guide to  
basic processing*. Retrieved from:  
[http://oystersetcetera.files.wordpress.com/2011/03/oystershellmethodsmanual  
version11.pdf](http://oystersetcetera.files.wordpress.com/2011/03/oystershellmethodsmanualversion11.pdf)

Yates, S, 2018 *On the path of the pilgrims*.  
<http://www.thurrockindependent.com/2018/01/14/on-the-path-of-the-pilgrims/>.  
Thurrock and South Essex Independent 14 January 2018

Young, C J, 1977 *The Roman pottery industry of the Oxford region*. Oxford: BAR Brit  
Ser 43



## Appendix E Abbreviations and Glossary

---

- ADS** Archaeology Data Service. Digital archaeological archive
- CBM** Ceramic Building Material
- CDM** Construction Design Manual. Health and safety guidance for the construction industry
- CPD** Continuing Professional Development
- ClfA** Chartered Institute for Archaeologists
- DBA** Desk Based Assessment. Detailed assessment of archaeology and other aspects of the historic environment
- DCO** Development Consent Order
- ECC** Essex County Council
- EIA** Environmental Impact Assessment. Detailed study of environmental impacts as directed under the The Town and Country Planning (Environmental Impact Assessment) Regulations 2017 following on from EU Directive EIA Directive (85/337/EEC)
- ES** Environmental Statement. The principal environmental report detailing environmental impacts within an EIA
- GLAAS** Greater London Archaeological Advisory Service
- GPS** Global Positioning System
- HER** Historic Environment Record
- LTC** Lower Thames Crossing
- MCIfA** Member of the Chartered Institute for Archaeologists
- MoRPHE** Management of Research Projects in the Historic Environment
- NMP** National Mapping Programme. A study of aerial photographs and digitisation of resulting data into GIS. Originally funded by Historic England
- OASIS** Online Access to the Index of archaeological investigations. The OASIS project brings together a number of strategic partners: the Archaeology Data Service, Historic England, Historic Environment Scotland, and the Royal Commission on the Ancient and Historical Monuments of Wales under the umbrella of the University of York
- OCN** Old County Number. Historic England's reference for material that is not readily-available online and may represent historic archaeological work that consists of paper archives or has yet to be formally reported on
- OS** Ordnance Survey
- PINS** Planning Inspectorate
- RAMS** Risk Assessment Method Statement
- SMC** Scheduled monument consent
- TDR** Trusted Digital Repository
- UKIC** United Kingdom Institute for Conservation
- VCH** Victoria County History
- WSI** Written Project of Investigation. A detailed method statement for archaeological work
- WSL** Western Southern Link. The Western Southern Link (WSL) is an alternative for Short List Routes 2, 3 and 4 to the south of the River Thames.

## Appendix F Site Summary

---

|                           |   |
|---------------------------|---|
| <b>Site name:</b>         | Lower Thames Crossing Land Parcels 55, 56 and 58, London Borough of Havering and Brentwood, Essex |
| <b>Site code:</b>         | HUP20 (London) and LTC56W20 (Essex)   |
| <b>Grid Reference</b>     | NGR 558409 188554   |
| <b>Type:</b>              | Evaluation  |
| <b>Date and duration:</b> | 7th September to 8th October 2020   |
| <b>Area of Site:</b>      | c 34.7ha  |

### Location of archive:

The archive from HUP 20 and LTC56W20 (Land Parcels 55, 56 and 58) will form part of the overall trial trenching scheme archive. This will be deposited in a repository consistent with the standards required by the Museums and Galleries Commission following completion of the archaeological phase of this project. This may either be with the local receiving museums or, if no such repositories are available, with a repository for the whole project designated by LTC. LTC retain the overall responsibility for the successful deposition of the project archive.

Currently, the archive is held at Oxford Archaeology's head office, Janus House, Osney Mead, Oxford, Oxfordshire, OX2 0ES. Oxford Archaeology will store the archive for LTC for a maximum period of 2 years following the completion of the project. If the storage of the archive at OA's office extends past this period, an extension to the storage period and final deposition timetable will be reviewed by OA and LTC and agreed with the major stakeholders.

### Summary of Results:

Oxford Cotswold Archaeology was commissioned by Balfour Beatty to undertake a trial trench evaluation of Land Parcels 55, 56 and 58 covered by WSI N of the Lower Thames Crossing Pre-Enabling Works, centred on NGR 558409 188554. Land parcel 55 is located within the London borough of Havering, while Land Parcels 56 and 58 are located in Brentwood, in the county of Essex. A total of 165 trenches were excavated and recorded between 7th September and 8th October 2020.

Of the 165 trenches excavated, 52 trenches were found to contain a low density of archaeological remains comprising ditches, pits, postholes and natural features such as tree-throw holes. Slight concentrations of features were revealed in the east of the site within Land Parcel 56.

A small quantity of worked flint of Mesolithic/Neolithic date provides a limited and perhaps transitory presence in the wider landscape during the earlier prehistoric period. A small number of pits and a ditch containing middle Bronze Age to early Iron Age pottery provide further evidence of low-level prehistoric activity on site and within the surrounding landscape.

Evidence of Roman activity is limited to two pits in the east of the site, within the north of Land Parcel 56, though they contained relatively large quantities of Roman pottery. The majority of this pottery dates to the late Roman period, though residual pottery of early-middle Roman date is also represented. These remains are suggestive of activity that may have been related to Roman settlement and agricultural activity encountered immediately to the north at Hobbs Hole.

Evidence of late Saxon and medieval activity was largely concentrated in a small number of trenches located in the east of the site towards the north of Land Parcel 56. Small quantities of 10th- to 14th-century pottery were recovered from a few ditches and pits. It is probable that they were related to agricultural activity associated with nearby settlement.

Late post-medieval/modern remains were revealed across the site in the form of ditches that correspond with field boundaries depicted on historic Ordnance Survey mapping, and residual finds in topsoil deposits. These remains are demonstrative of agricultural use of the landscape during this period.

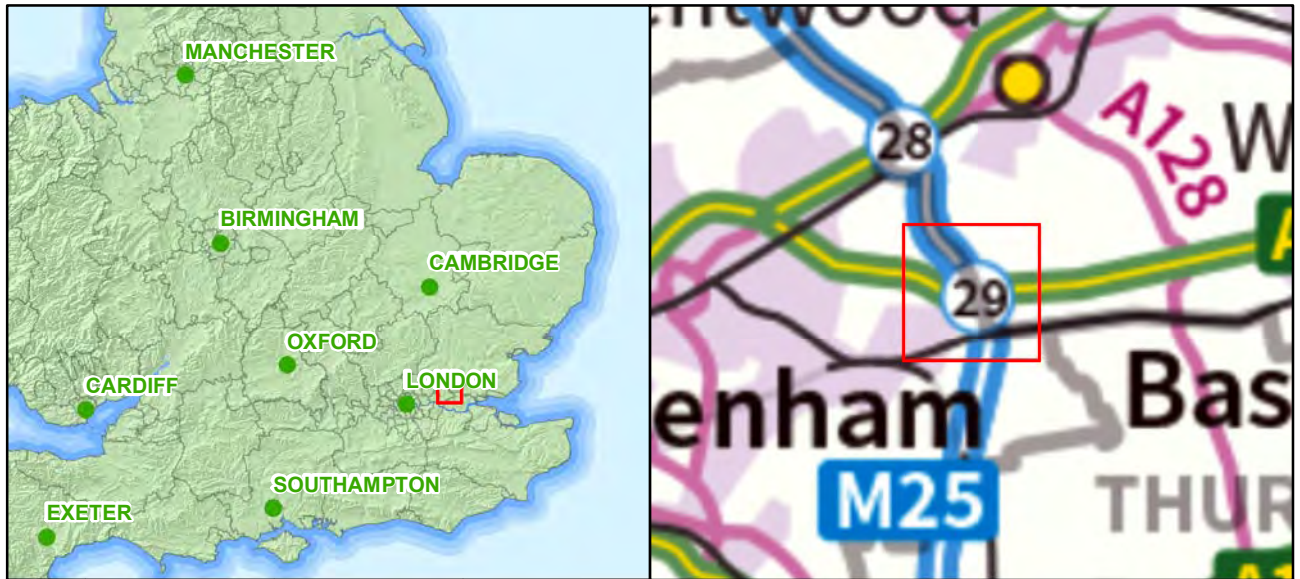

\\10.0.10.86\Projects\MLTCEV\_Lower\_Thames\_Crossing\010\Geomatics\03 GIS Projects - LTC56W20\Figures\LTC56W20\_Fig 1.mxd\caroline.sourday\04/12/2020

Contains OS data © Crown Copyright and database right 2020  
 Source: Esri, DigitalGlobe, GeoEye, Earthstar Geographics, CNES/Airbus DS, USDA,

Figure 1: Site location

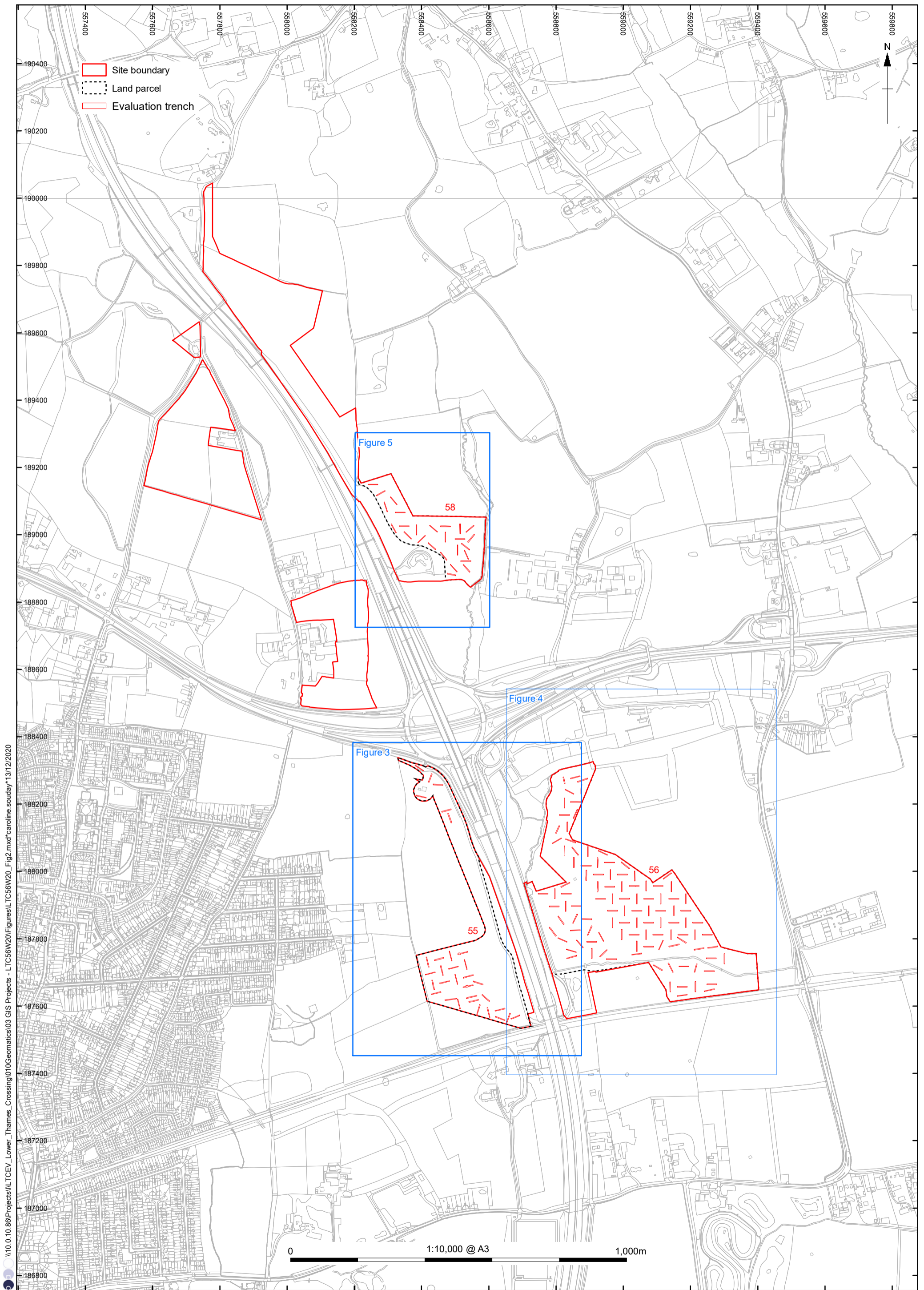

\\10.0.10.86\Projects\IL\TCEV\_Lower\_Thames\_Crossing\010\Geomatics\03 GIS Projects - LTC56W20\Figures\LTC56W20\_Fig2.mxd\*caroline.souday\*13/12/2020

Figure 2: Overall trench location plan

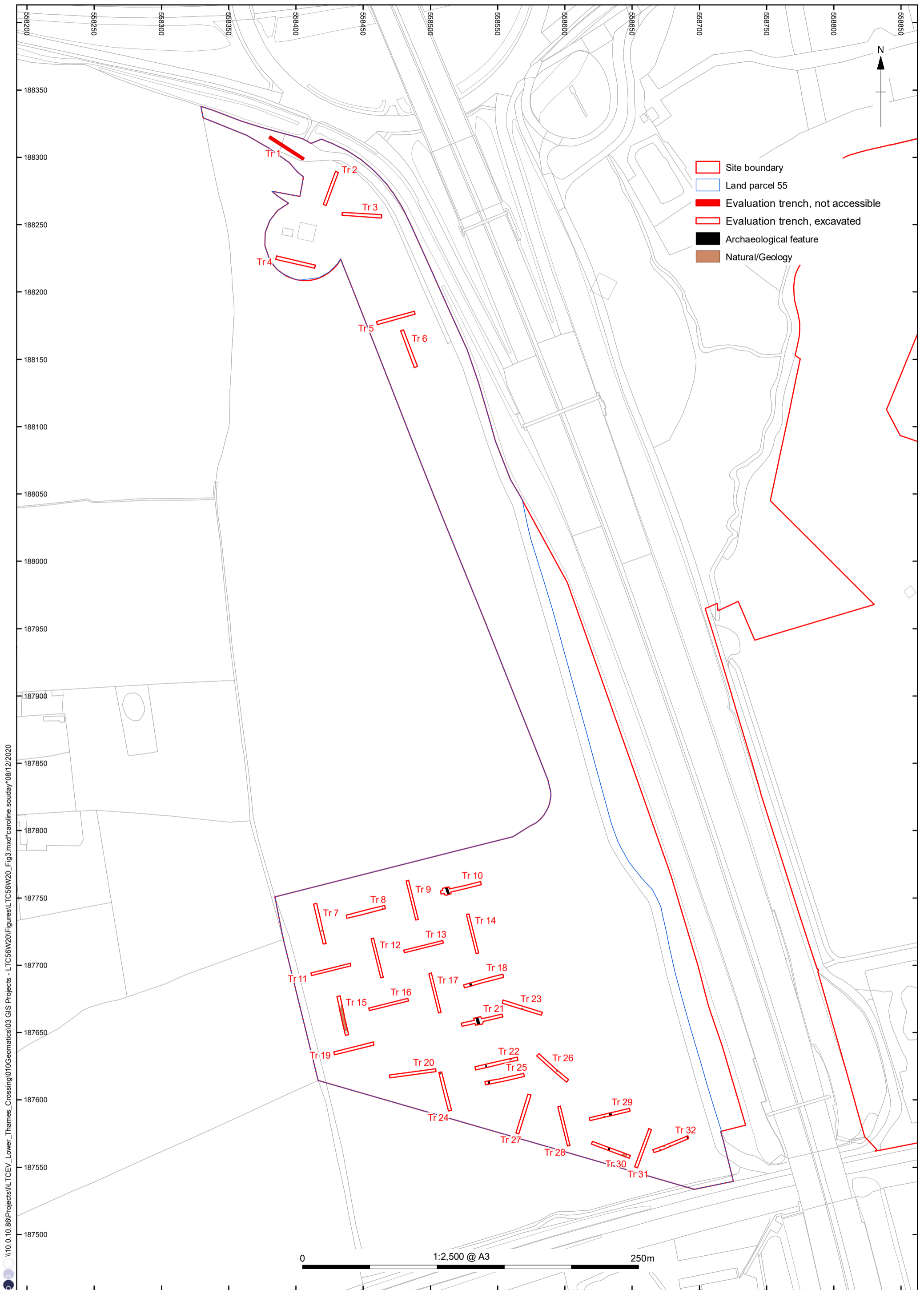
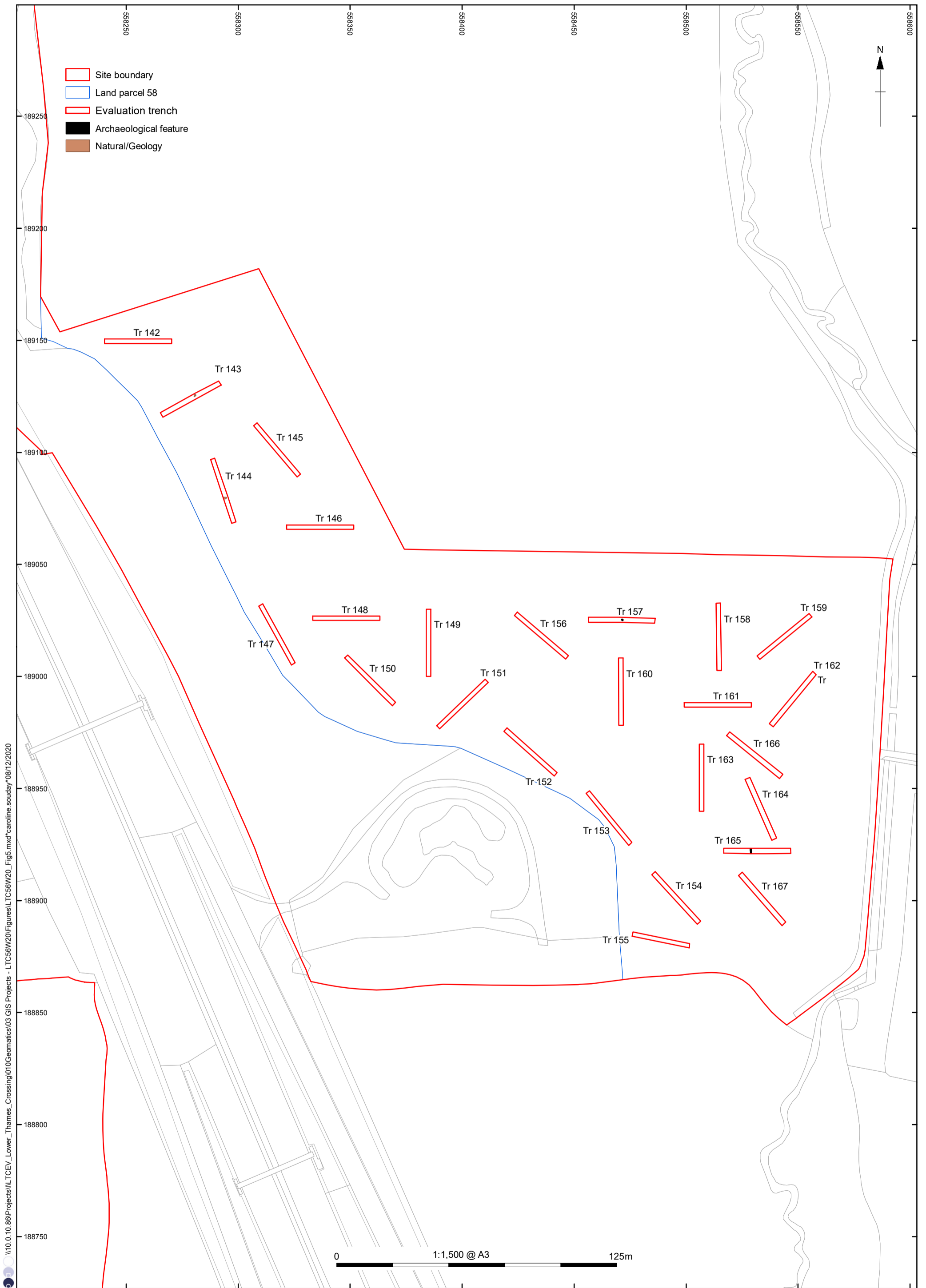

Figure 3: Land Parcel 55 trench location plan



I:\10.0.10.86\Projects\Lower\_Thames\_Crossing\010\Geomatics\03 GIS Projects - LTC56W20\Figures\LTC56W20\Fig4.mxd\*caroline.souday\*10/12/2020

Figure 4: Land Parcel 56 trench location plan



\\10.0.10.86\Projects\IL TCEV\_Lower\_Thames\_Crossing\010\Geomatics\03 GIS Projects - LTC56W20\Figures\LTC56W20\_Fig5.mxd\*caroline.souday\08/12/2020

Figure 5: Land Parcel 58 trench location plan



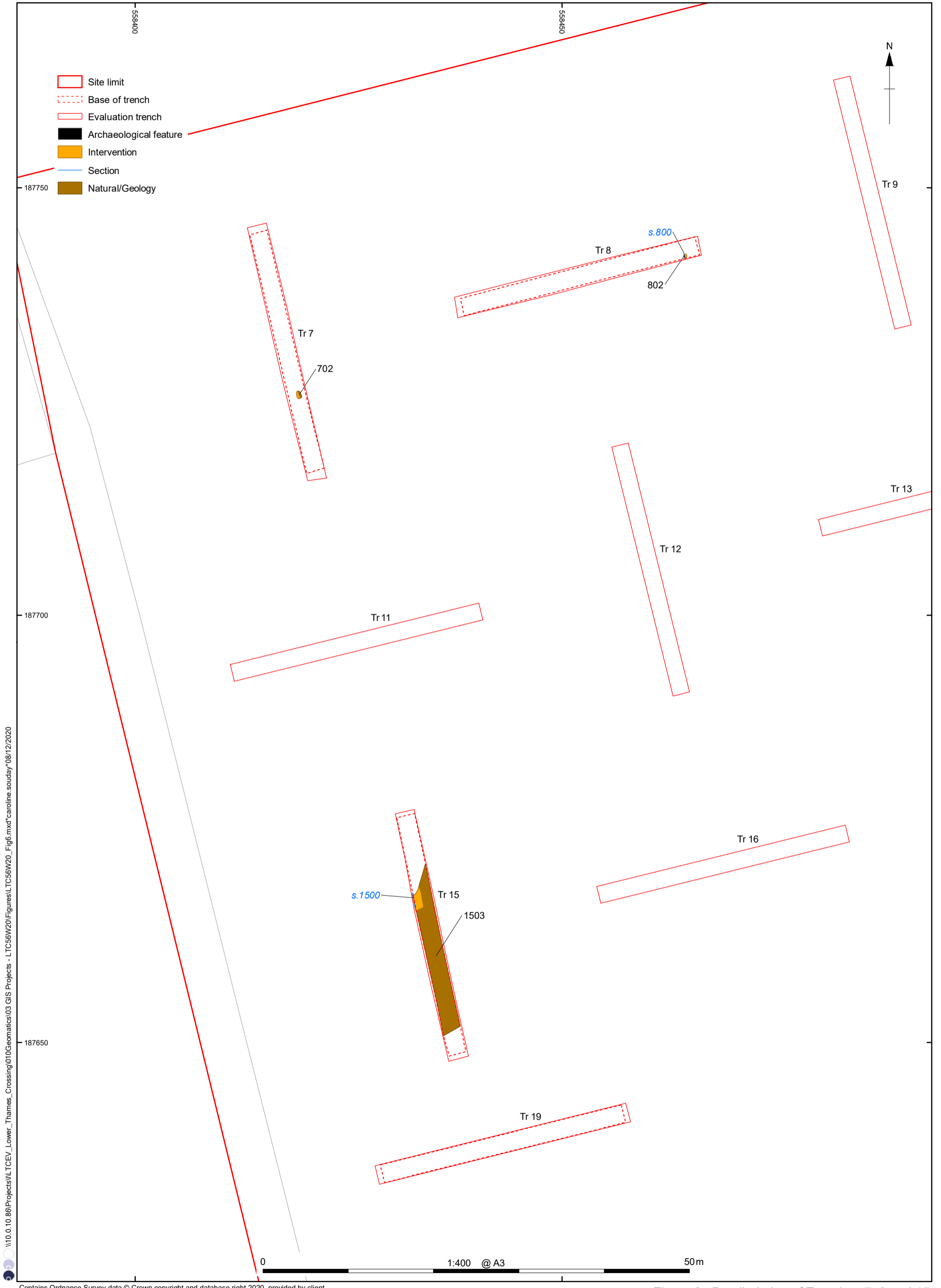

Figure 6: Detailed plan of Trenches 7, 8 and 15

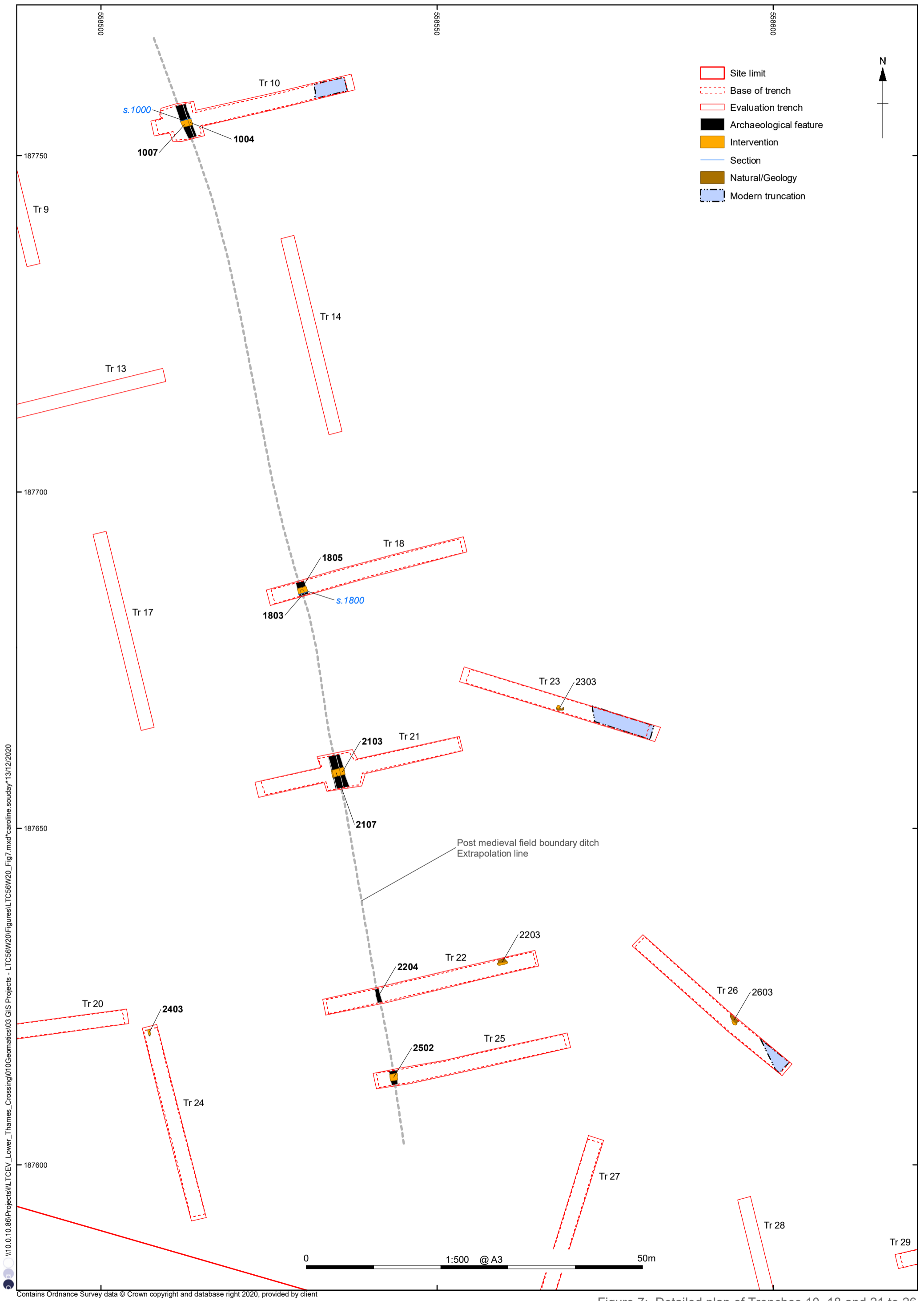

Figure 7: Detailed plan of Trenches 10, 18 and 21 to 26

\\10.0.10.86\Projects\IL TCEV\_Lower\_Thames\_Crossing\010\ecmatics\03 GIS Projects - L TC56W20\Figures\L TC56W20\_Fig8.mxd\*caroline.souday\*08/12/2020

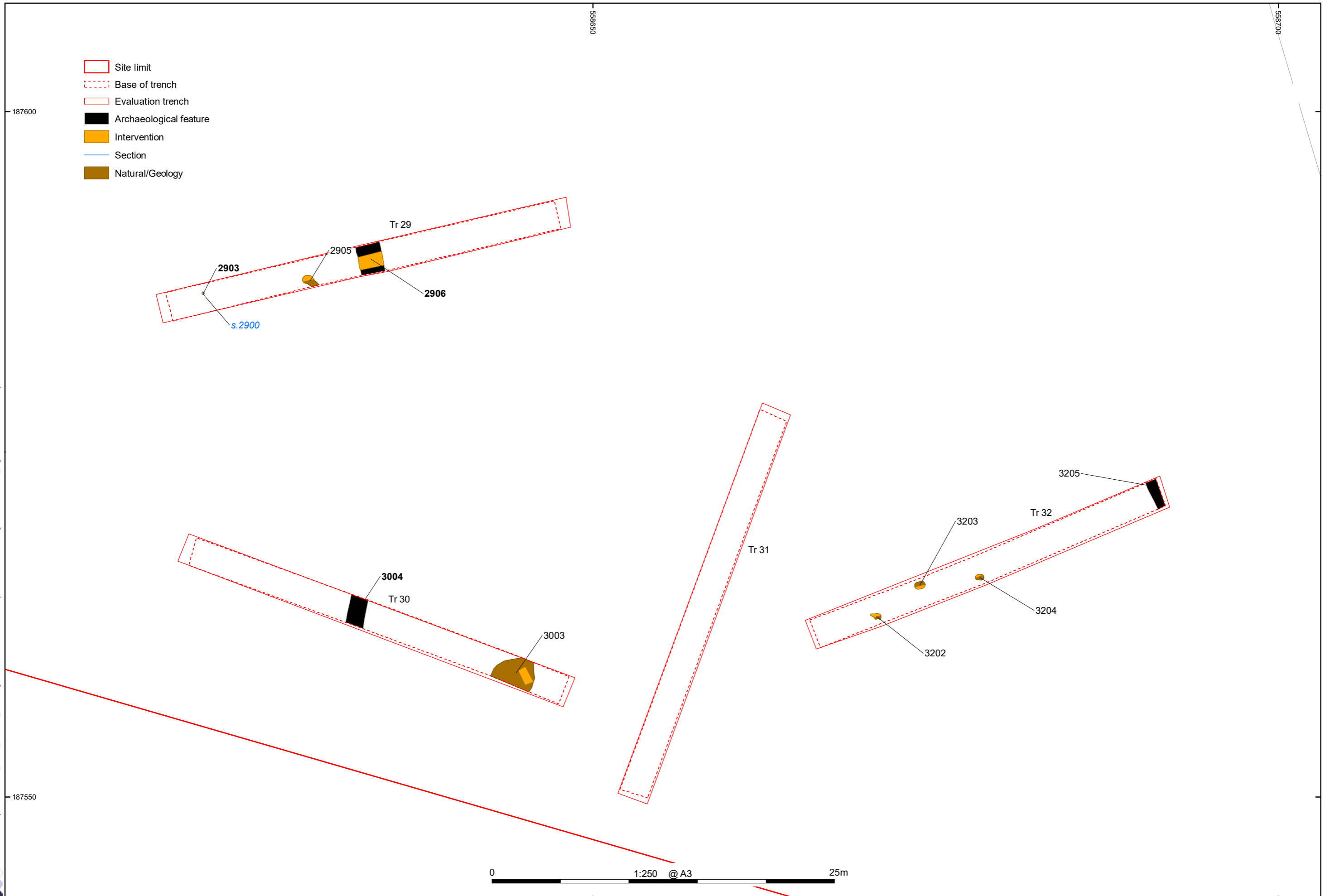

Figure 8: Detailed plan of Trenches 29, 30 and 32

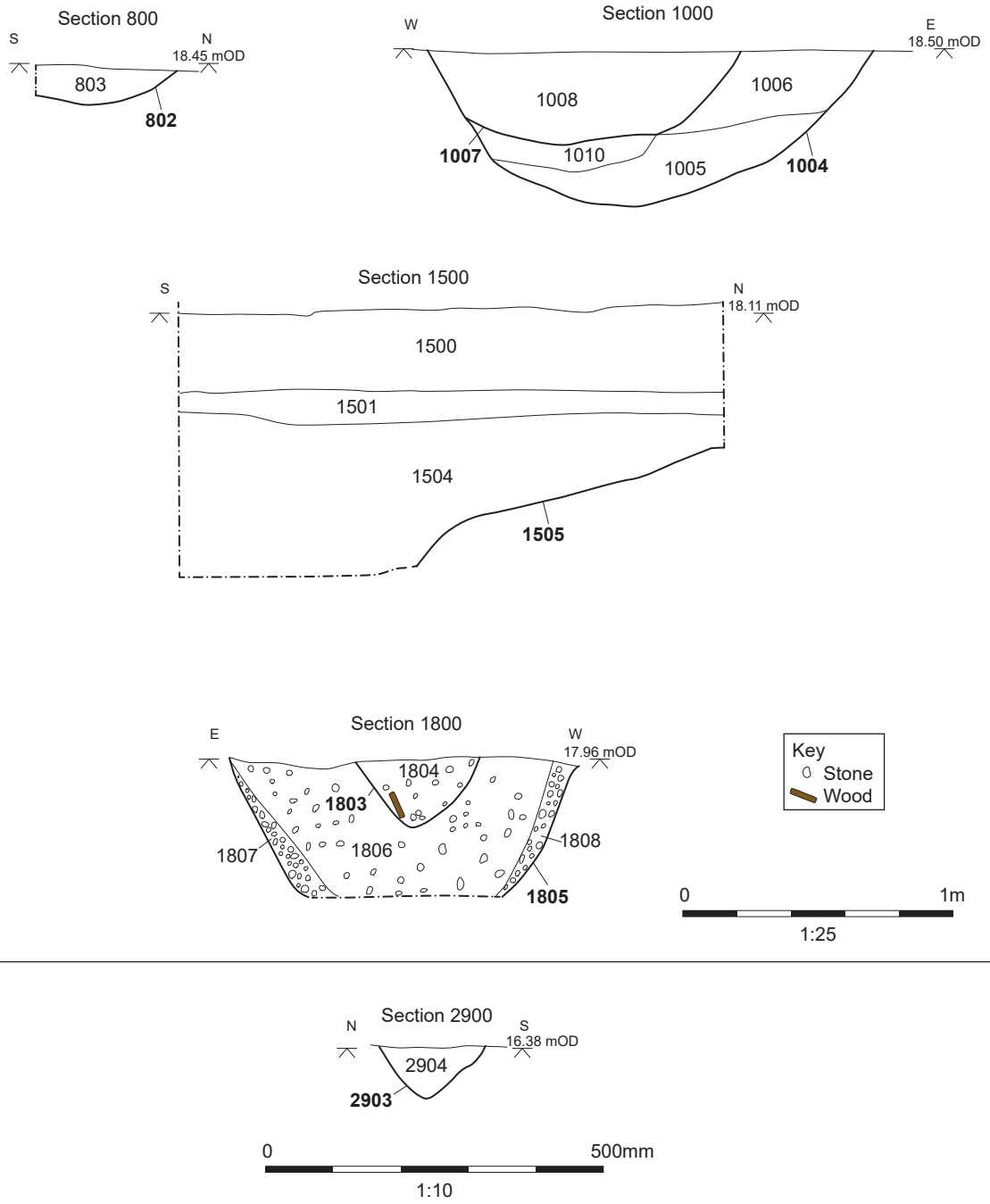
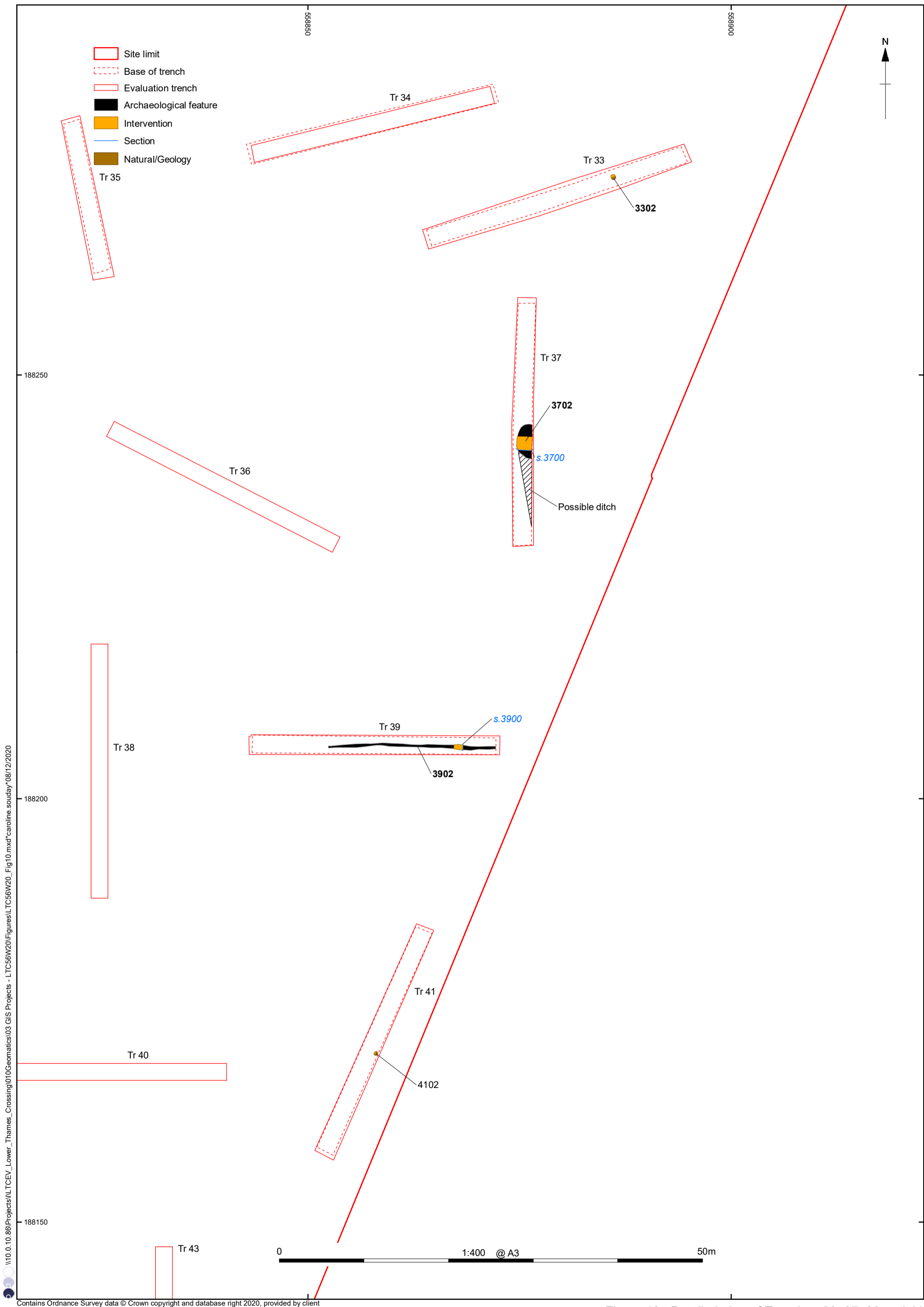

Figure 9: Sections (Trenches 8, 10, 15, 18 and 29)



\\10.0.10.86\Projects\ILTCEV\_Lower\_Thames\_Crossing\010\Geomatics\03 GIS Projects - LTC56W20\Figures\LTC56W20\_Fig10.mxd\*caroline.souday\*08/12/2020

Figure 10: Detailed plan of Trenches 33, 37, 39 and 41

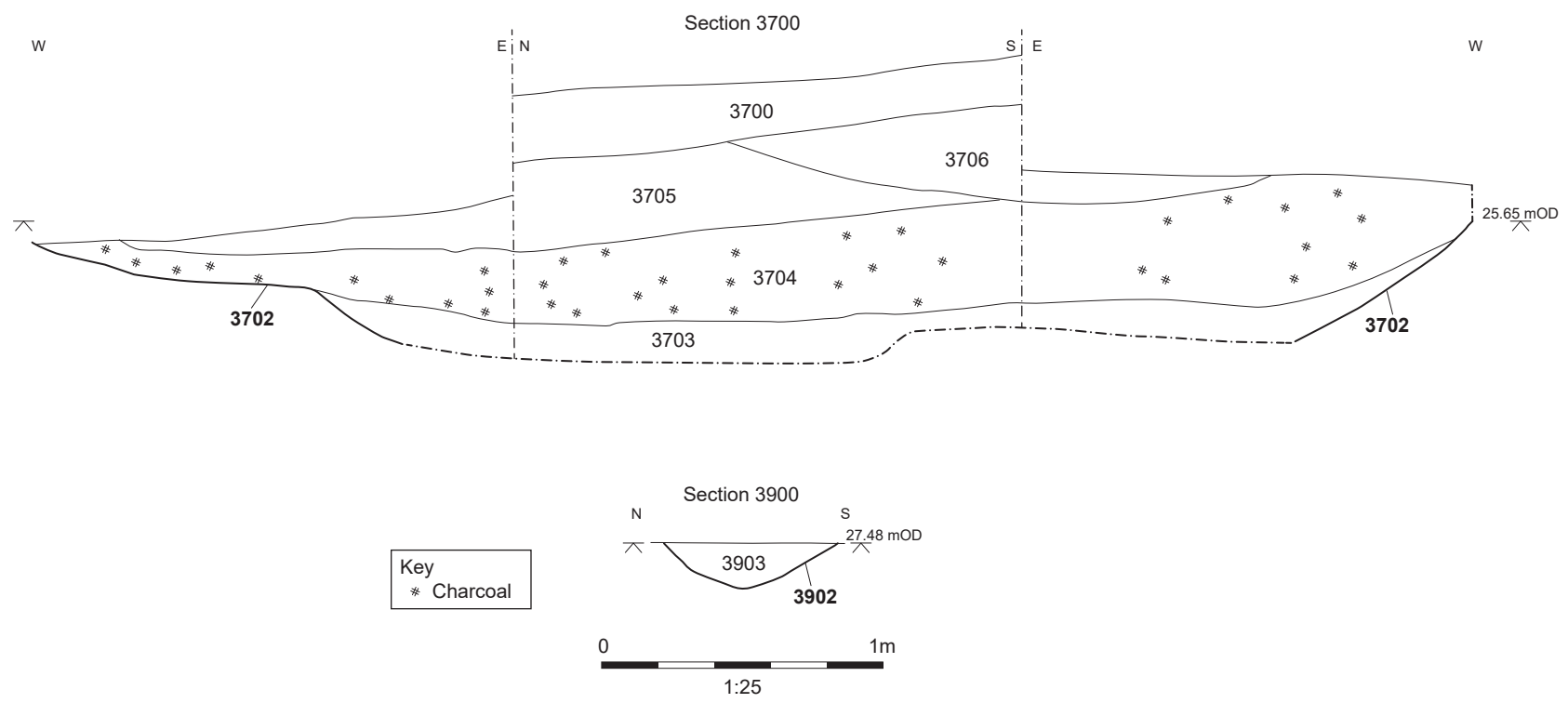
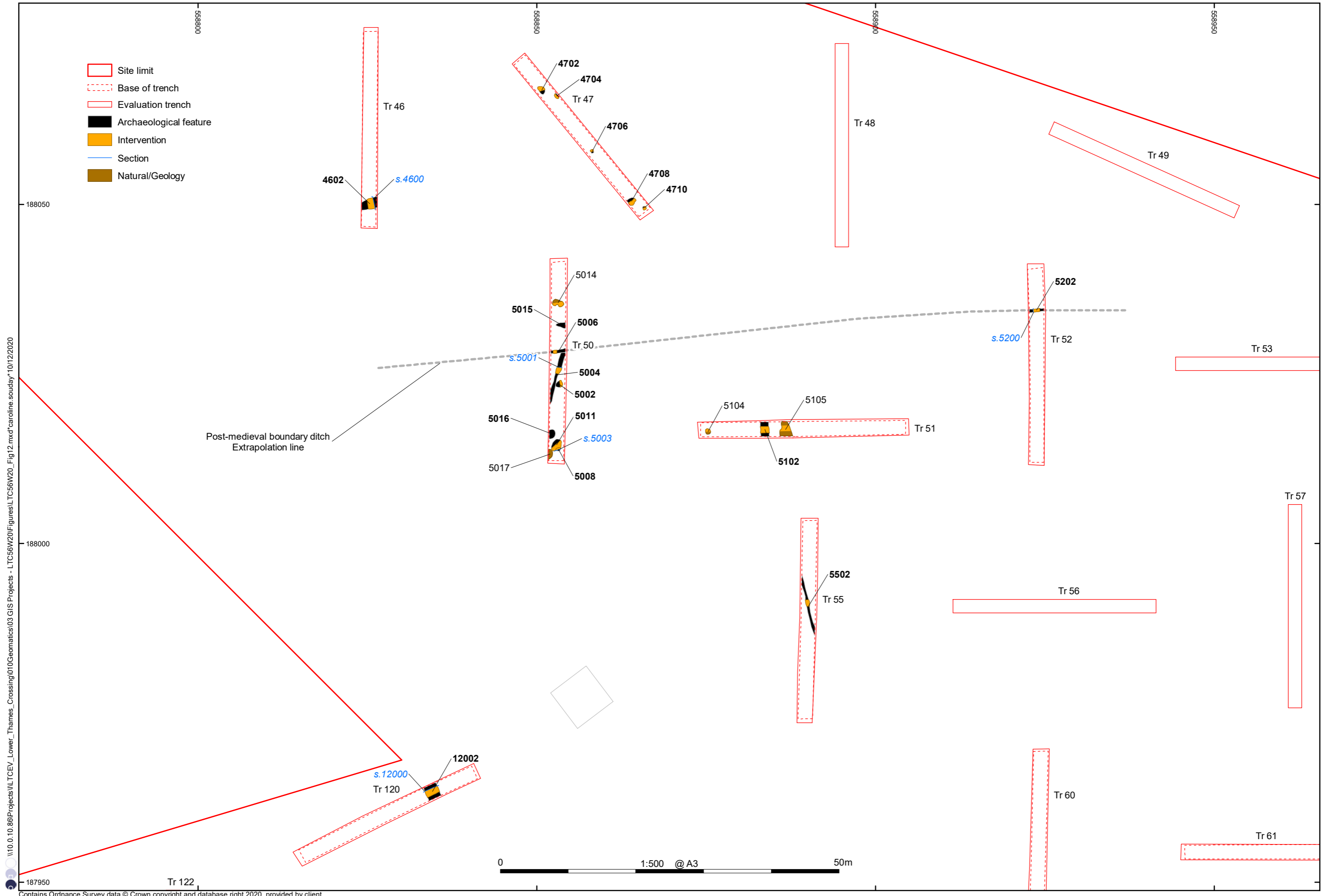

Figure 11: Sections (Trenches 37 and 39)



\\10.0.10.86\Projects\Lower\_Thames\_Crossing\010\geomatics\03\GIS\Projects - LTC56W20\Figures\LTC56W20\_Fig12.mxd\*caroline.souday\*10/12/2020

Figure 12: Detailed plan of Trenches 46, 47, 50 to 52, 55 and 120

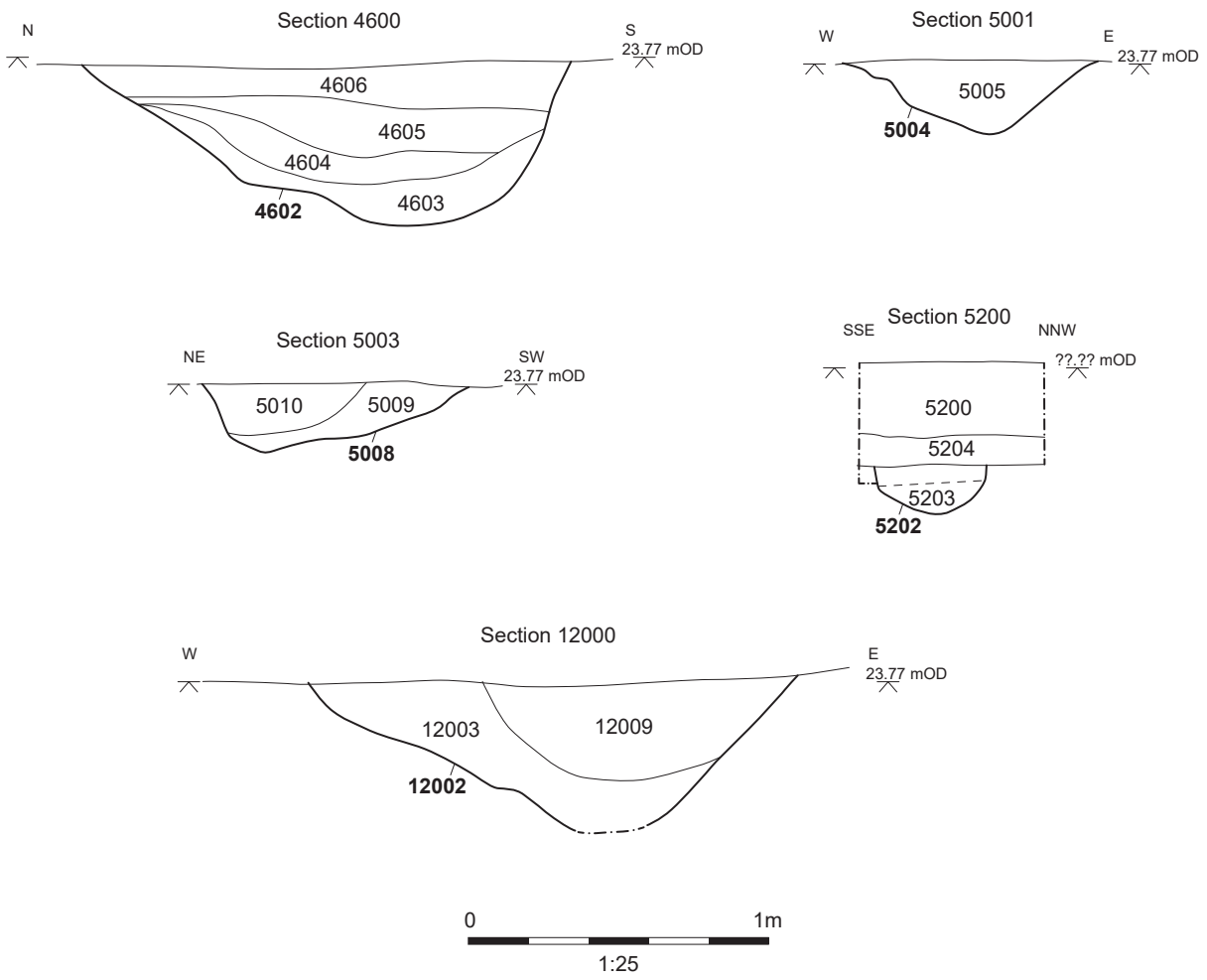

Figure 13: Sections (Trenches 46, 50, 52 and 120)



\\10.0.10.86\Projects\TCEV\_Lower\_Thames\_Crossing\01\Geomatics\03\GIS\Projects - LTC56W20\Figures\LTC56W20\_Fig14.mxd\*caroline.souday\*08/12/2020

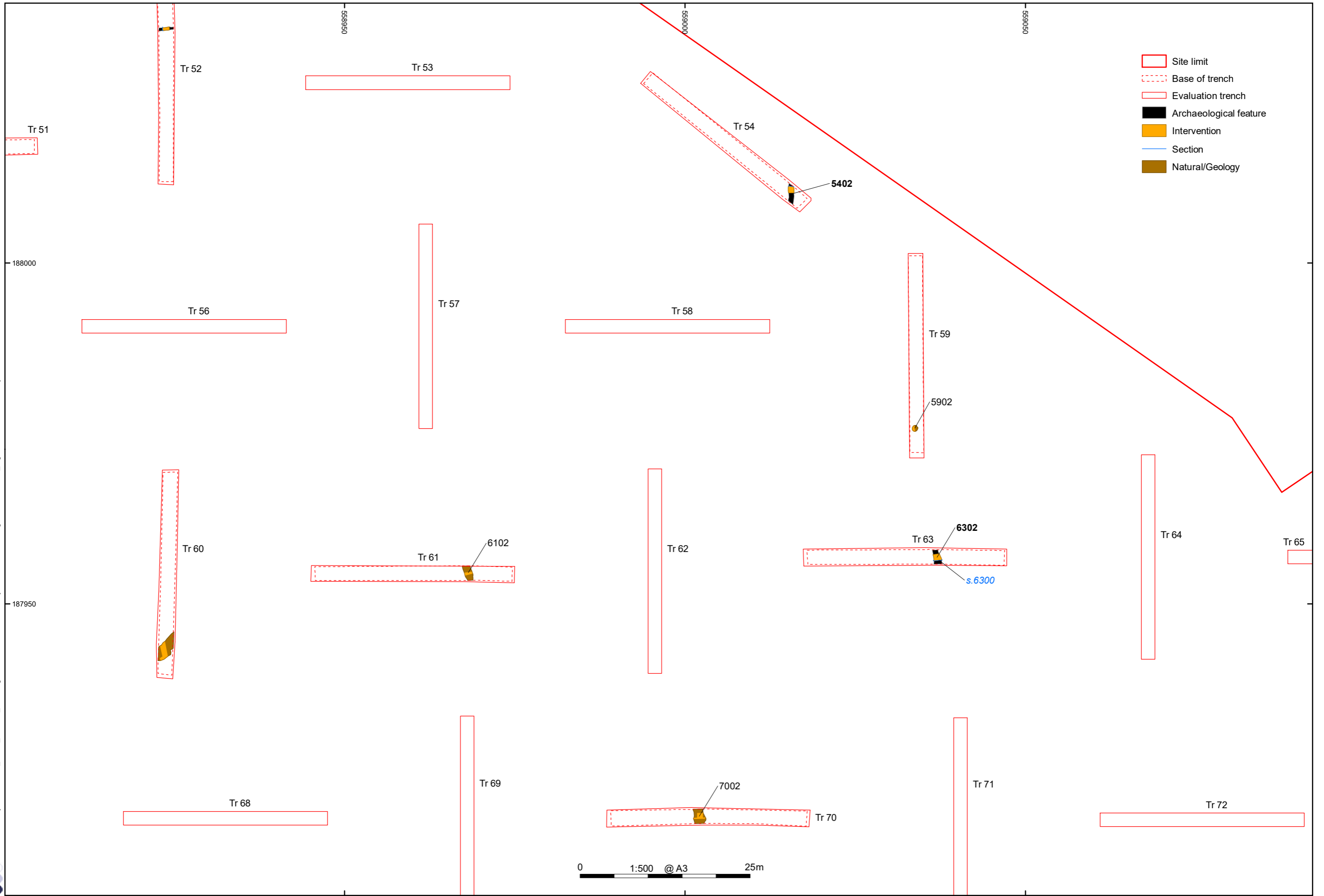

Figure 14: Detailed plan of Trenches 54, 59, 61, 63 and 70

\\10.0.10.86\Projects\Lower\_Thames\_Crossing\010\ecmatics\03 GIS Projects - LTC56W20\Figures\LTC56W20\_Fig15.mxd\*caroline.souday\*08/12/2020

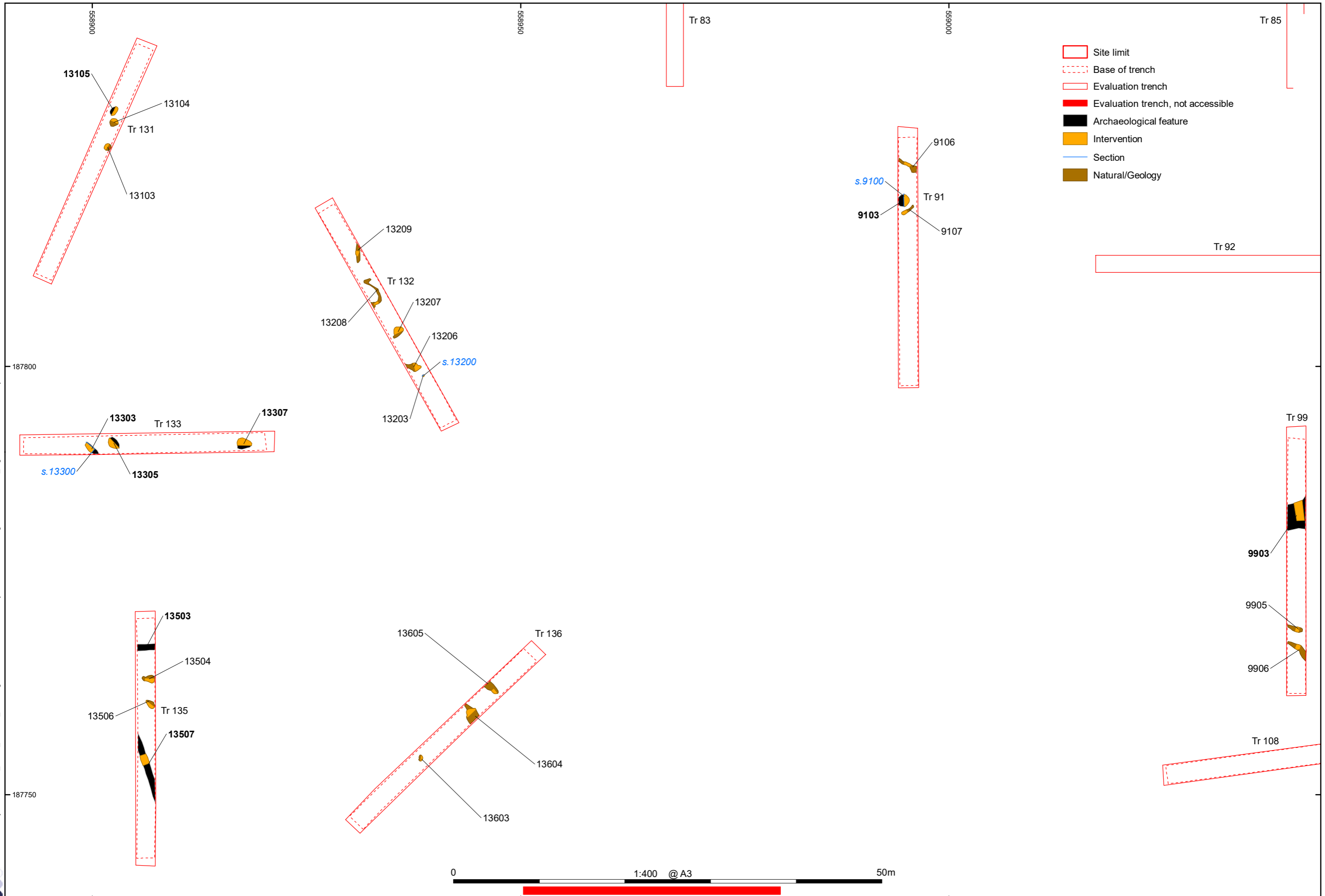

Figure 15: Detailed plan of Trenches 91, 99, 131 to 133, 135 and 136

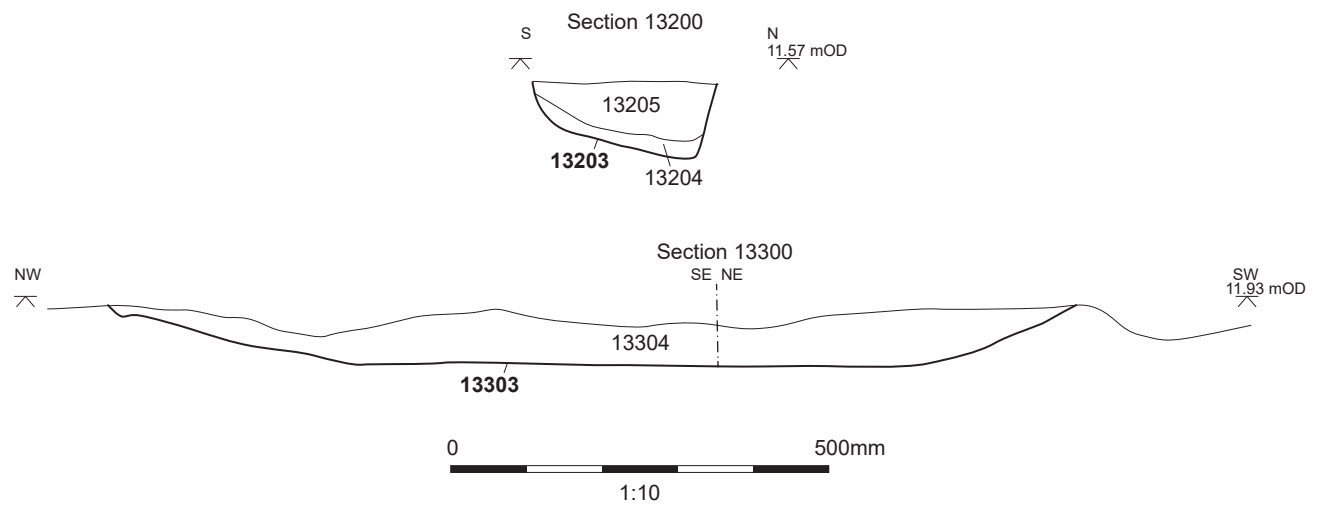
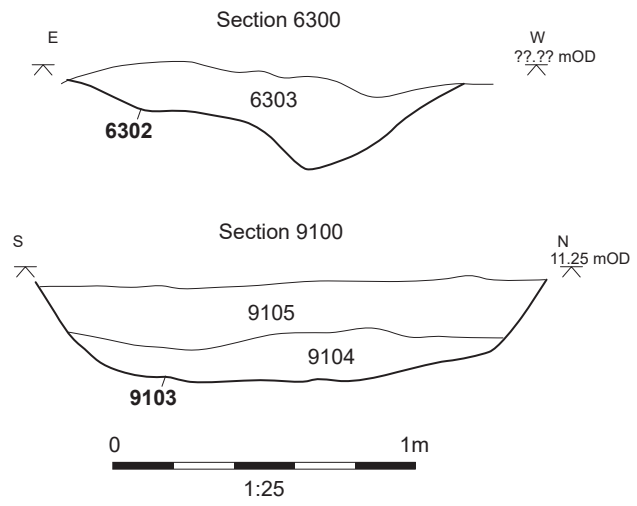
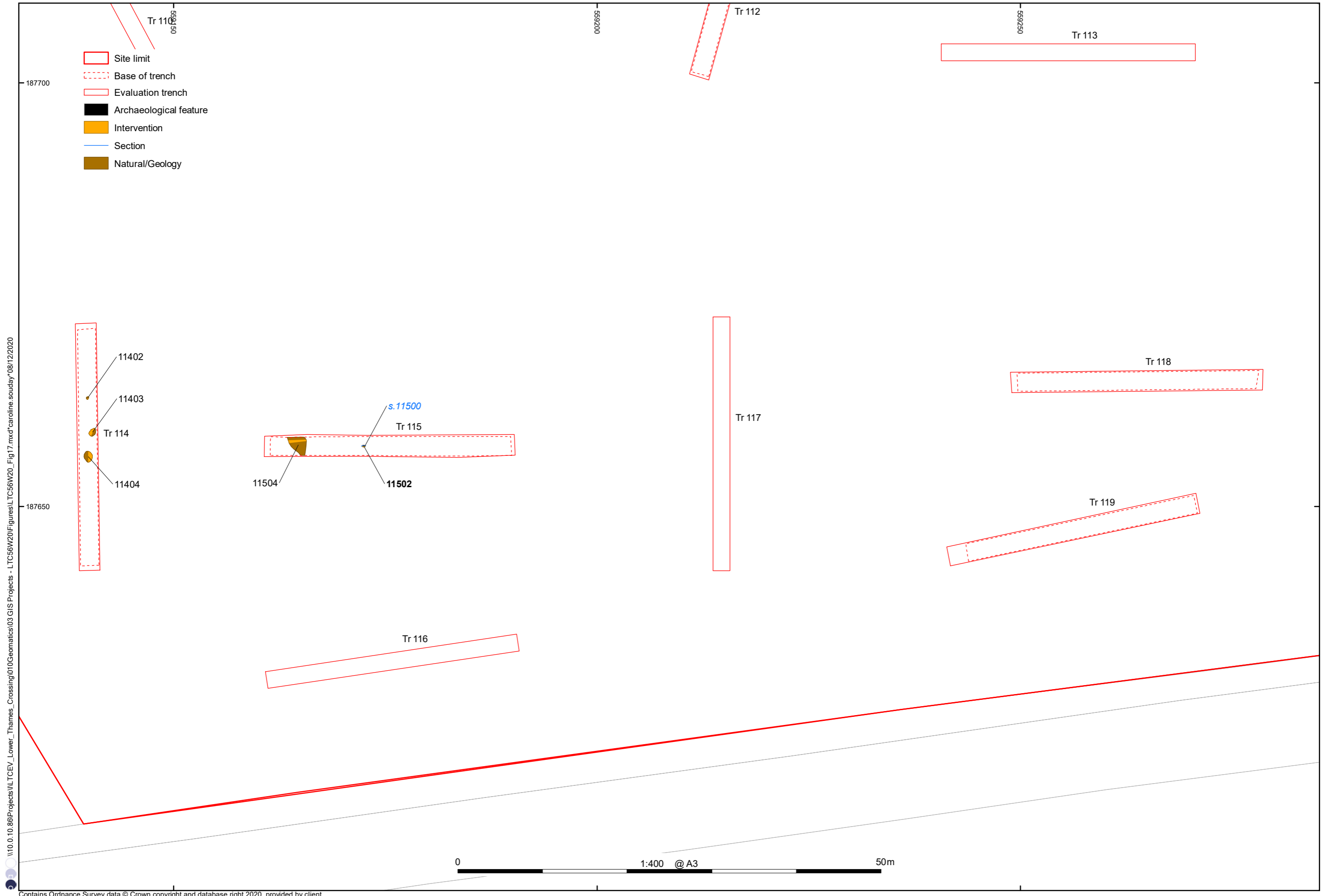

Figure 16: Sections (Trenches 63, 91, 132 and 133)



\\10.0.10.86\Projects\1\TCEV\_Lower\_Thames\_Crossing\01\Geomatics\03\GIS\Projects - LTC56W20\Figures\LTC56W20\_Fig17.mxd\*caroline.souday\*08/12/2020

Figure 17: Detailed plan of Trenches 114, 115 and 118

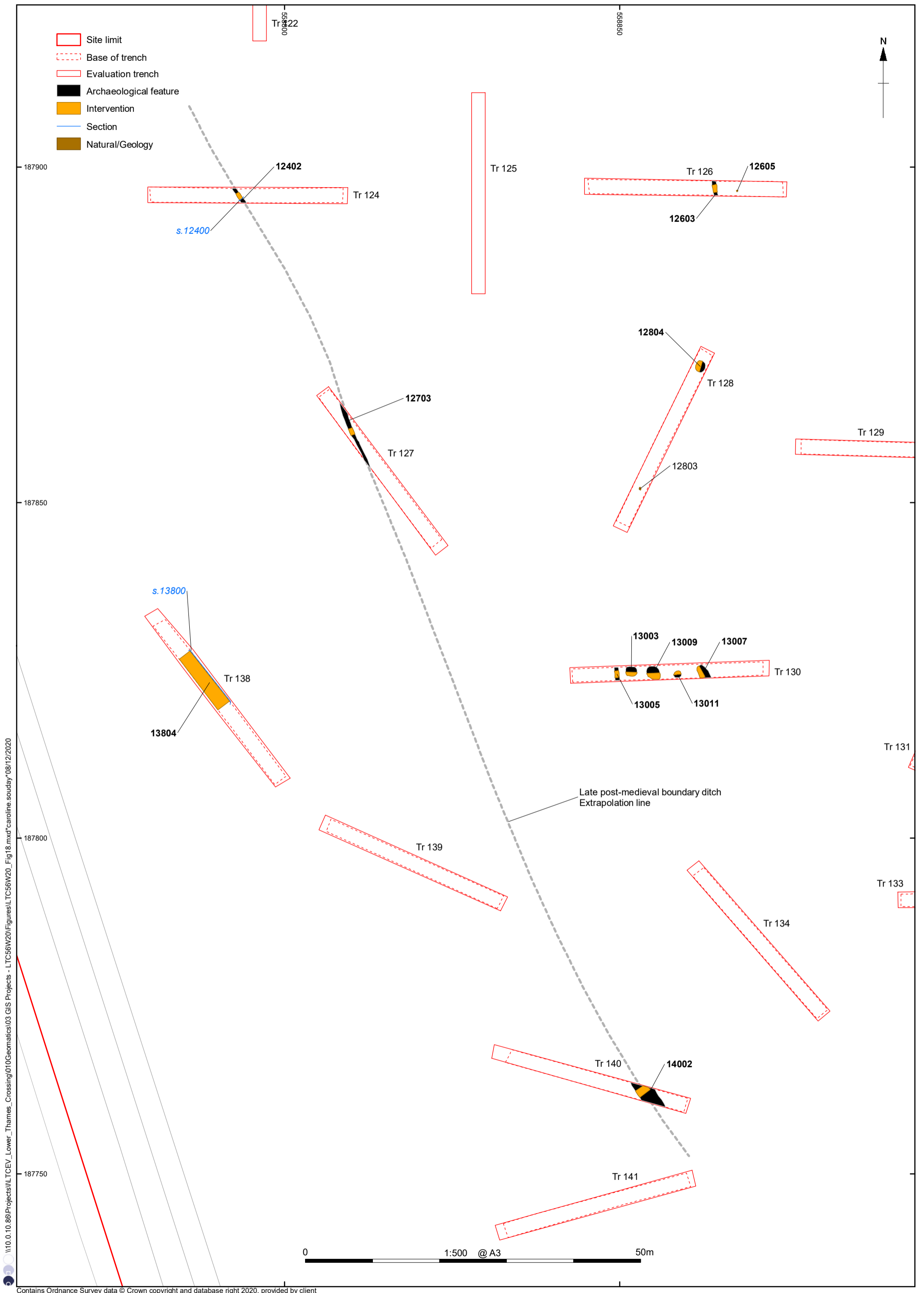

Figure 18: Detailed plan of Trenches 124, 126 to 128, 130, 138 and 140

\\10.0.10.86\Projects\IL TCEV\_Lower\_Thames\_Crossing\010\Geomatics\03 GIS Projects - LTC56W20\Figures\LTC56W20\_Fig18.mxd\*caroline.souday\*0812/2020

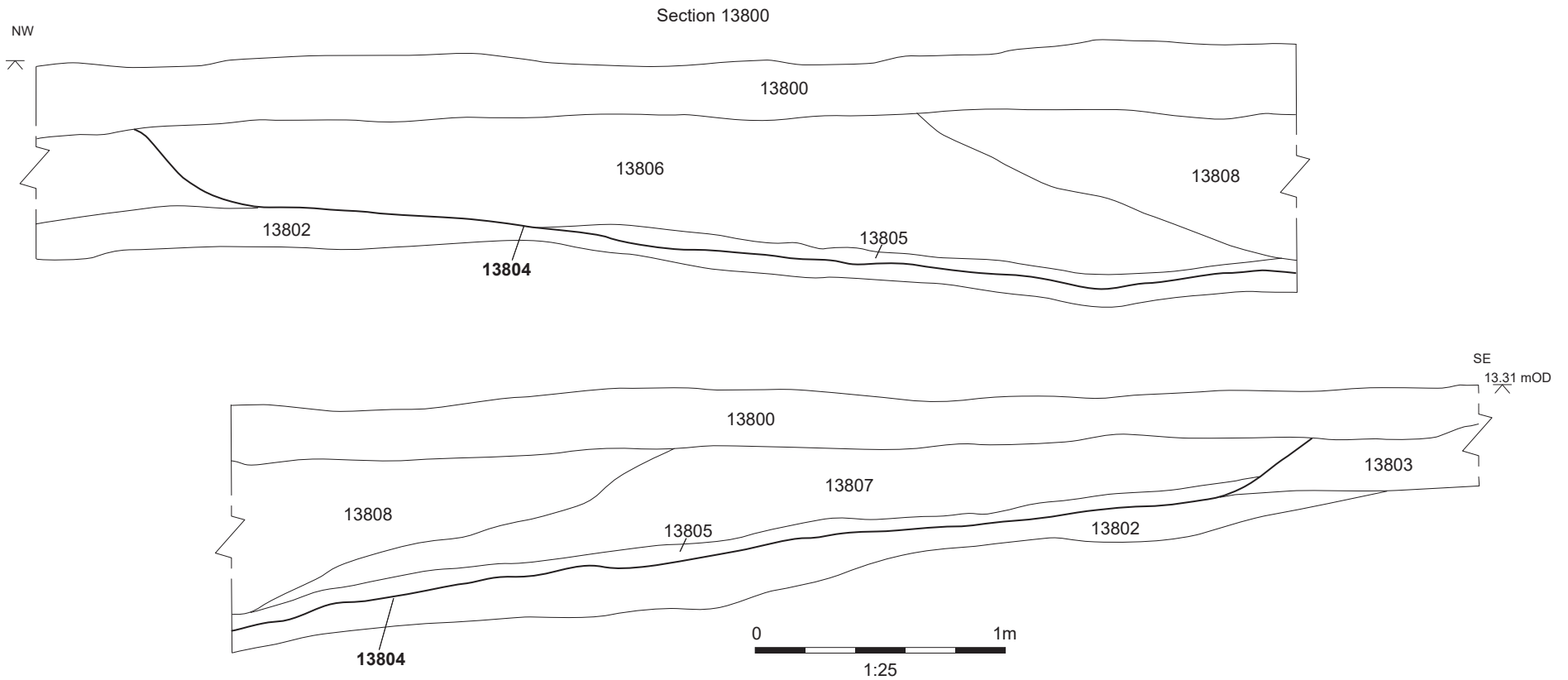
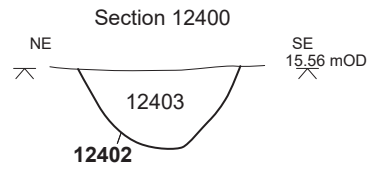
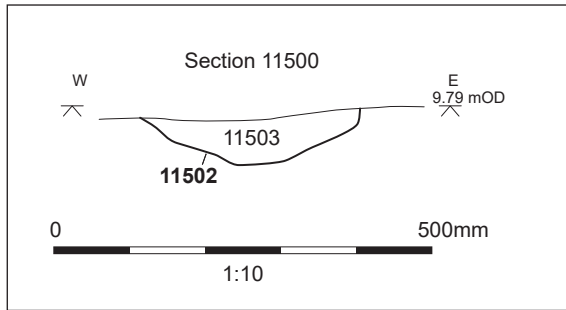

Figure 19: Sections (Trenches 115, 124 and 138)

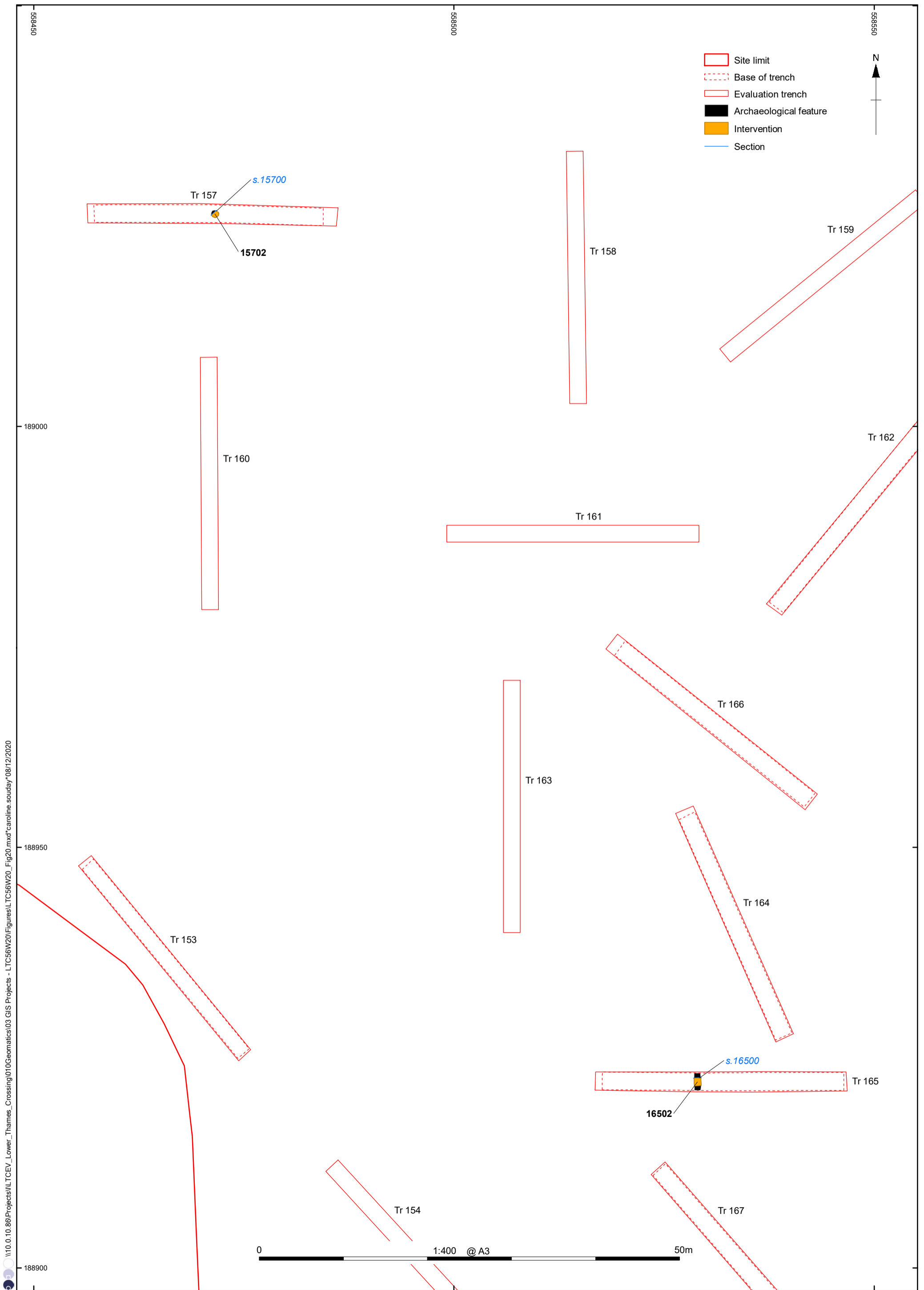

Figure 20: Detailed plan of Trenches 157 and 165

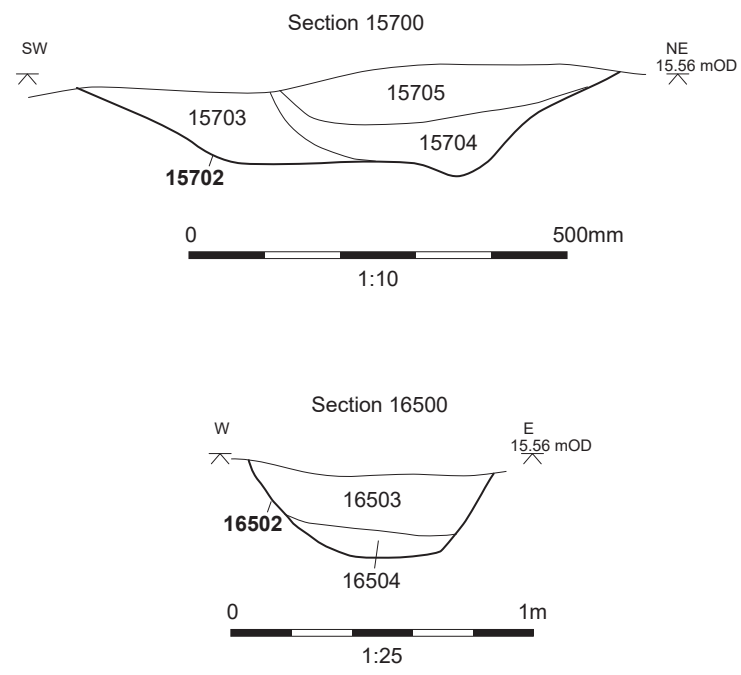
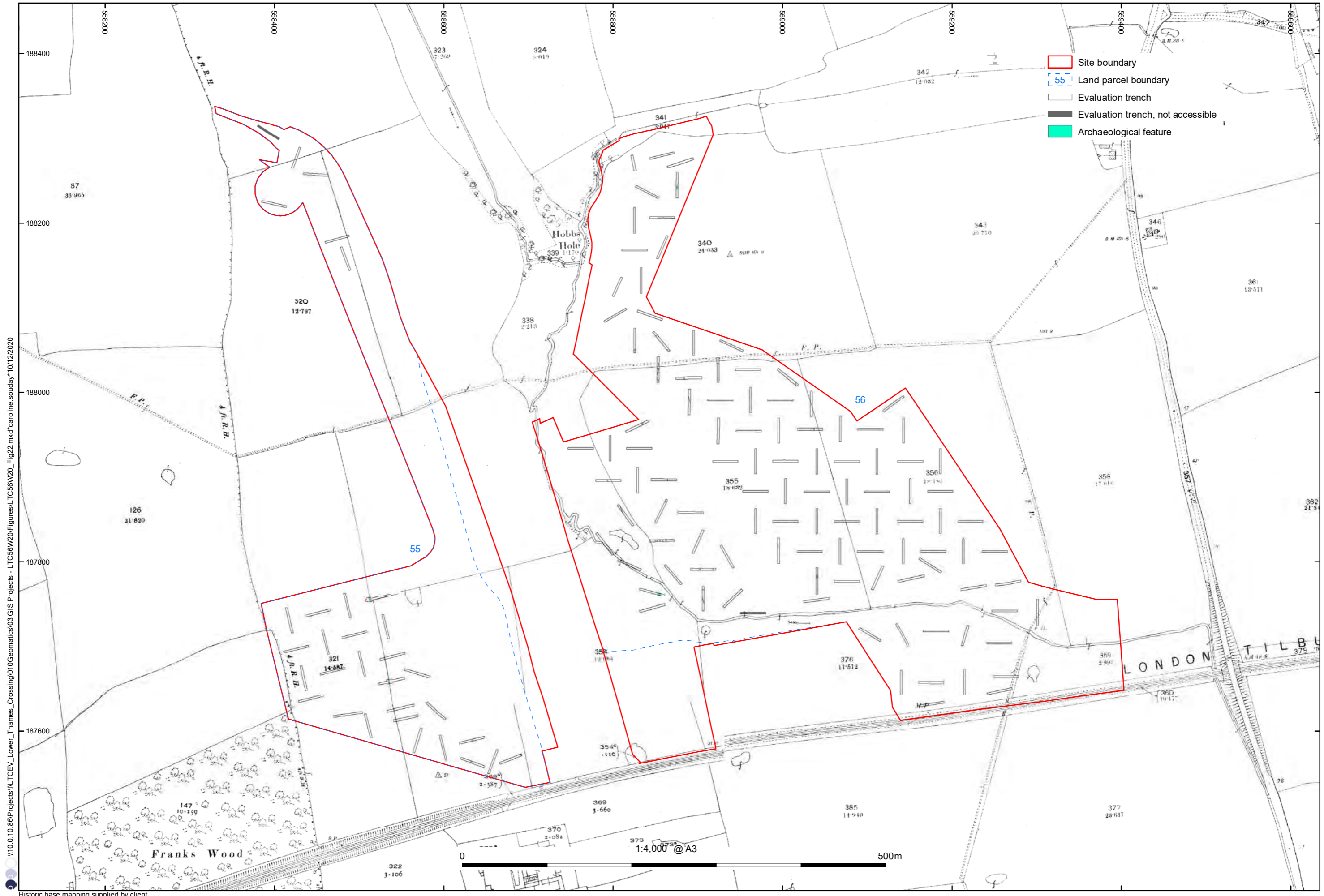

Figure 21: Sections (Trenches 157 and 165)





\\10.0.10.86\Projects\Lower\_Thames\_Crossing\010G\emacials\03 GIS Projects - LTC56W20\Figures\LTC56W20\_Fig22.mxd\*caroline.souday\*10/12/2020

Historic base mapping supplied by client

Figure 22: 1896 Ordnance Survey

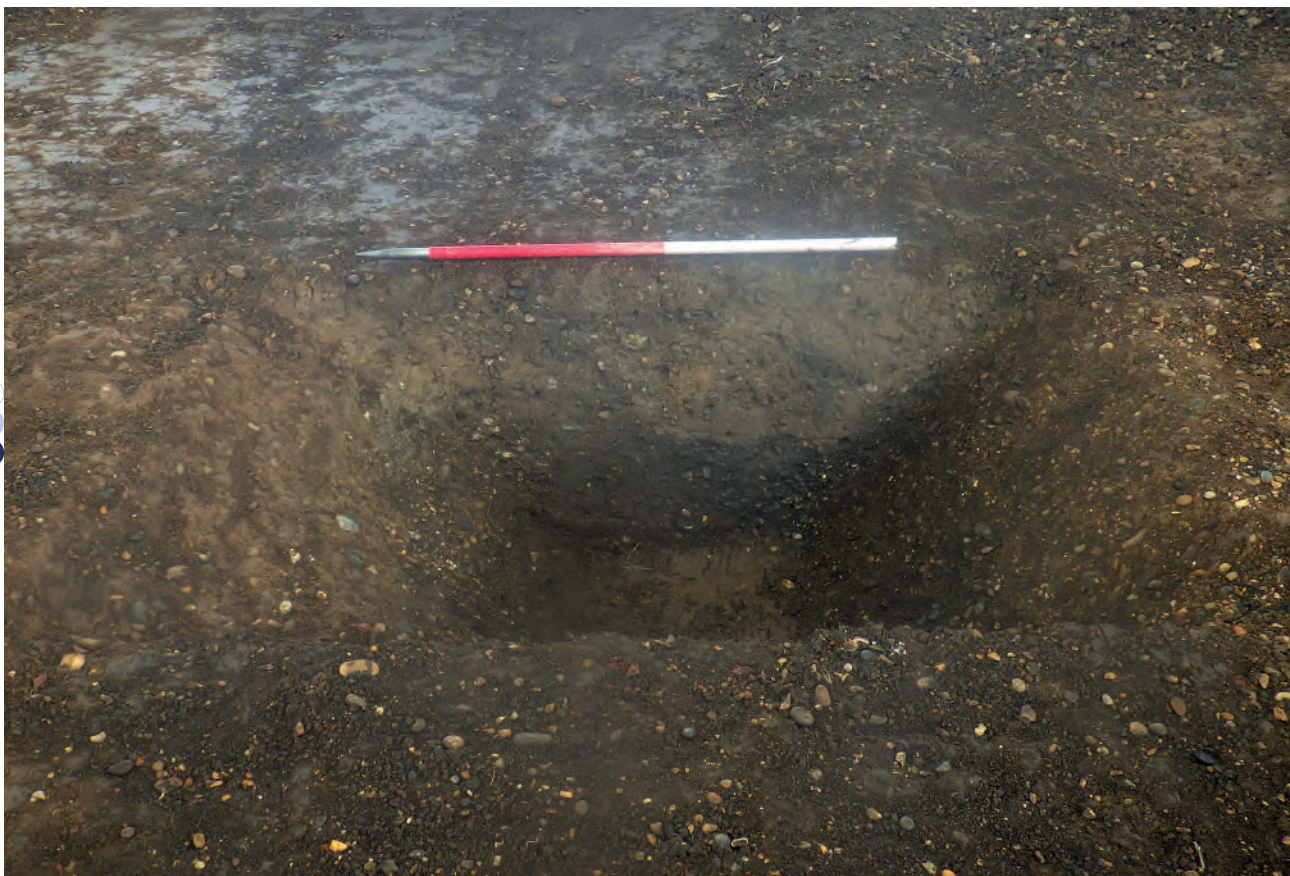

Plate 1: Ditch 2103 and recut 2107, looking south



Plate 2: Posthole 2903, looking east



Plate 3: Pit 4702, looking south



Plate 4: Pit 5011, looking north-west



Plate 5: Pit 13307, looking south



Plate 6: Ditch 13507, looking NNW



Plate 7: Ditch 12603, looking south



Plate 8: Ditch 12703, looking SSE



Plate 9: Pit 12804, looking south



Plate 10: Pit 13003, looking north



Plate 11: Feature 13804, looking south-east

If you need help accessing this or any other National Highways information, please call **0300 123 5000** and we will help you.

© Crown copyright 2022.

You may re-use this information (not including logos) free of charge in any format or medium, under the terms of the Open Government Licence. To view this licence:

visit [www.nationalarchives.gov.uk/doc/open-government-licence/](http://www.nationalarchives.gov.uk/doc/open-government-licence/)

write to the **Information Policy Team, The National Archives, Kew, London TW9 4DU**, or email [psi@nationalarchives.gsi.gov.uk](mailto:psi@nationalarchives.gsi.gov.uk).

Mapping (where present): © Crown copyright and database rights 2022 OS 100030649. You are permitted to use this data solely to enable you to respond to, or interact with, the organisation that provided you with the data. You are not permitted to copy, sub-licence, distribute or sell any of this data to third parties in any form.

If you have any enquiries about this publication email [info@nationalhighways.co.uk](mailto:info@nationalhighways.co.uk) or call **0300 123 5000\***.

\*Calls to 03 numbers cost no more than a national rate call to an 01 or 02 number and must count towards any inclusive minutes in the same way as 01 and 02 calls.

These rules apply to calls from any type of line including mobile, BT, other fixed line or payphone. Calls may be recorded or monitored.

Printed on paper from well-managed forests and other controlled sources when issued directly by National Highways.

Registered office Bridge House, 1 Walnut Tree Close, Guildford GU1 4LZ

National Highways Company Limited registered in England and Wales number 09346363